

Product Overview

The QPB7420 is a GaAs pHEMT single ended RF amplifier IC featuring 20dB of flat gain and low noise. This IC is designed to support Fiber to The Home (FTTH) applications from 47 to 1218MHz using a single 5V supply, or it can be used from 3V to 8V depending on linearity requirements. QPB7420 offers low noise and distortion plus high gain in a SOT-89 package for convenient layout and design in set top and infrastructure projects for 75 Ω CATV and satellite applications.



SOT-89 Package

Functional Block Diagram

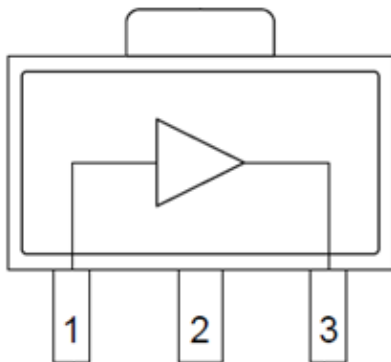

Top View

Key Features

- 47 MHz to 1218 MHz Operation
- 3 V, 5 V, and 8 V Operation
- Gain; 20 dB Typical
- Noise Figure; 1.1 dB Typical at 850 MHz
- Adjustable Bias Using External Resistors
- Convenient SOT-89 Package
- RoHS Compliant

Applications

- FTTH GPON and GEON
- DOCSIS 3.1
- Head End CMTS Equipment
- Optical Node
- Satellite Low Noise Amplifier
- Cable Modem and Set Top Box
- Single Ended Gain Block

Ordering Information

Part Number	Description
QPB7420SB	Sample bag with 5 pieces
QPB7420SR	7" Reel with 100 pieces
QPB7420TR13	13" Reel with 2500 pieces
QPB7420PCK-1	47 – 1218 MHz PCBA with 5 pc sample bag

Absolute Maximum Ratings

Parameter	Rating
Supply Voltage (V_{DD})	+10 V
Supply Current (I_{DD})	140 mA
Maximum Input Level	65 dBmV
Operating Temperature Range	-40 to +85 °C
Storage Temperature Range	-65 to +150 °C
Maximum Junction Temperature	+150 °C

Exceeding any one or a combination of the Absolute Maximum Rating conditions may cause permanent damage to the device. Extended application of Absolute Maximum Rating conditions to the device may reduce device reliability.

Electrical Specifications – 3 V

Parameter	Condition ⁽¹⁾	Min	Typ	Max	Unit
Supply Voltage (V_{DD})			3		V
Supply Current (I_{DD})			35		mA
Frequency Range		47		1218	MHz
Gain			20		dB
Gain Slope			1.0		dB
Reverse Isolation			22		dB
Input Return Loss			21		dB
Output Return Loss			21		dB
Noise Figure			1.3		dB
CSO	20 dBmV / ch output, 80 NTSC + 108 QAM, flat		54		dBc
CTB	20 dBmV / ch output, 80 NTSC + 108 QAM, flat		75		dBc
CCN	20 dBmV / ch output, 80 NTSC + 108 QAM, flat		52		dB
OIP2L	7 dBm / tone output		38		dBm
OIP2H	7 dBm / tone output		37		dBm
OIP3	7 dBm / tone output		28		dBm
OP1dB			15.3		dBm
Thermal Resistance	Θ_{JC}		35		°C/W

Notes:

1. Typical performance at these conditions: Temp = +25 °C, V_{DD} = +3 V, 75 Ω system, Full band unless otherwise noted

Electrical Specifications – 5 V

Parameter	Condition ⁽¹⁾	Min	Typ	Max	Unit
Supply Voltage (V_{DD})			5		V
Supply Current (I_{DD})			55		mA
Frequency Range		47		1218	MHz
Gain			20.4		dB
Gain Slope			1.1		dB
Reverse Isolation			23		dB
Input Return Loss			23		dB
Output Return Loss			20		dB
Noise Figure			1.2		dB
CSO	20 dBmV / ch output, 80 NTSC + 108 QAM, flat		60		dBc
CTB	20 dBmV / ch output, 80 NTSC + 108 QAM, flat		77		dBc
CCN	20 dBmV / ch output, 80 NTSC + 108 QAM, flat		55		dB
OIP2L	7 dBm / tone output		44		dBm
OIP2H	7 dBm / tone output		41		dBm
OIP3	7 dBm / tone output		35.5		dBm
OP1dB			20		dBm
Thermal Resistance	Θ_{JC}		35		$^{\circ}\text{C/W}$

Notes:

1. Typical performance at these conditions: Temp = +25 $^{\circ}\text{C}$, V_{DD} = +5V, 75 Ω system, Full band unless otherwise noted

Electrical Specifications – 8 V

Parameter	Condition ⁽¹⁾	Min	Typ	Max	Unit
Supply Voltage (V_{DD})			8		V
Supply Current (I_{DD})			90		mA
Frequency Range		47		1218	MHz
Gain			20.6		dB
Gain Slope			1.1		dB
Reverse Isolation			23		dB
Input Return Loss			19		dB
Output Return Loss			17		dB
Noise Figure			1.3		dB
CSO	28 dBmV / ch output, 80 NTSC + 108 QAM, flat		60		dBc
CTB	28 dBmV / ch output, 80 NTSC + 108 QAM, flat		76		dBc
CCN	28 dBmV / ch output, 80 NTSC + 108 QAM, flat		59		dB
OIP2L	7 dBm / tone output		52		dBm
OIP2H	7 dBm / tone output		47		dBm
OIP3	7 dBm / tone output		40		dBm
OP1dB			24.2		dBm
Thermal Resistance	Θ_{JC}		35		$^{\circ}\text{C/W}$

Notes:

1. Typical performance at these conditions: Temp = +25 $^{\circ}\text{C}$, V_{DD} = +8V, 75 Ω system, Full band unless otherwise noted

**Evaluation Board Bill of Materials**

Designator	Description	Manufacturer	Part Number
PCB	QPB7420-4000	DDI	QPB7420-4000(A)
U1	20dB FTTH Amplifier	Qorvo	QPB7420
B1	RES, 0 Ω , 5%, 1/10W, 0402	Kamaya, Inc	RMC1/16SJPTH
B2	FER, BEAD, 1.8K, 200mA, 0402	TDK	MMZ1005A182ET000
C1, C2, C5	CAP, 0.01 μ F, 10%, 50V, X7R, 0402	Murata Electronics	GCM155R71H103KA55D
C3	CAP, 0.6pF, +/-0.1pF, 50V, HI-Q, 0402	Murata Electronics	GJM1555C1HR60BB01D
C4	CAP, 0.3pF, +/-0.05pF, 50V, HI-Q, 0402	Murata Electronics	GJM1555C1HR30WB01D
C6	CAP, 330pF, 10%, 50V, X8L, 0402	Murata Electronics	GCM155L81H331KA37D
J1, J2	CONN, F FEM EDGE MOUNT, 75 OHMS, 0.068"	Millimeter Wave Technologies, LLC	MW-846-C-DD-75
J3, J4	TERM. SOLDER TURRET, 0.062 PCB	Mill-Max Manufacturing	2533-0-00-44-00-00-07-0
L1, L2	IND, 6.8nH, 5%, M/L, 0402	Murata Electronics	LQG15HN6N8J02D
L3	IND, 47nH, 5%, M/L, 0402	Murata Electronics	LQG15HN47NJ02D
R1	RES, 910 Ω , 5%, 1/16W, 0402	Panasonic Industrial	ERJ-2GEJ911X
R2	RES, 200 Ω , 5%, 1/16W, 0402	Kamaya, Inc	RMC1/16S-201JTH
R3, R4, R5, C7	Not Populated		

Evaluation Board Assembly Drawing

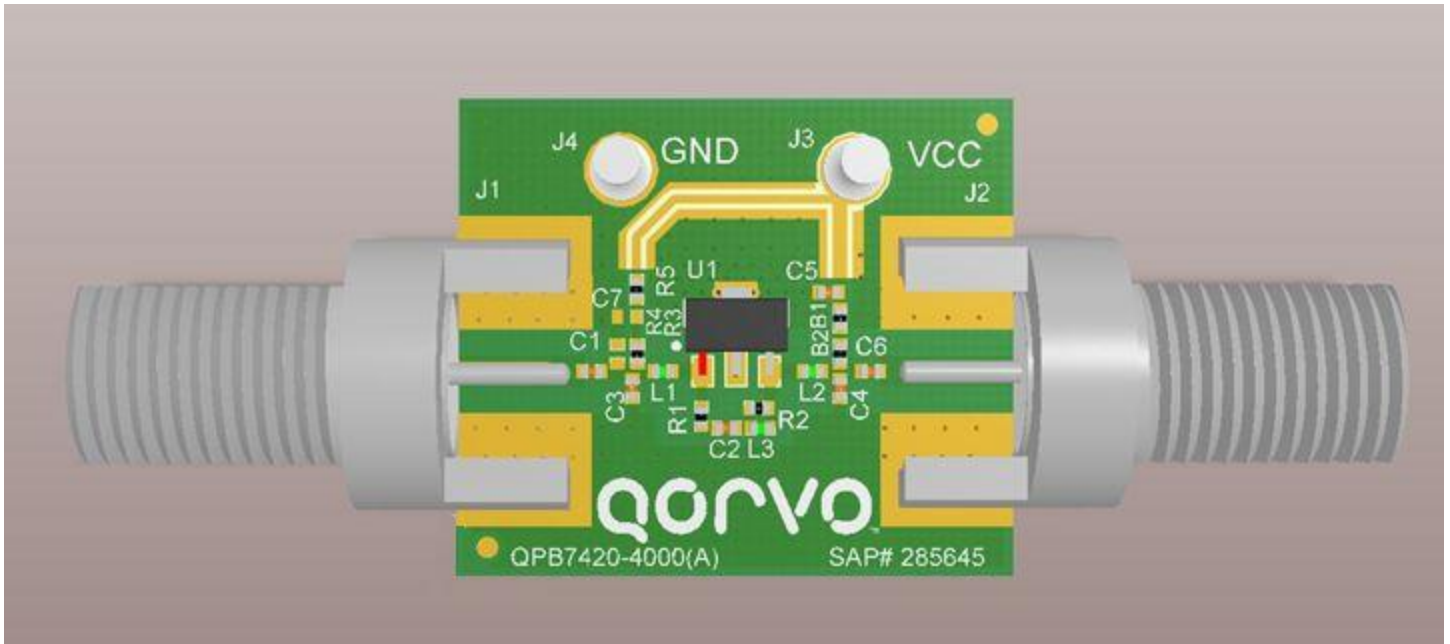

Typical Application Schematic, 47 MHz – 1218 MHz

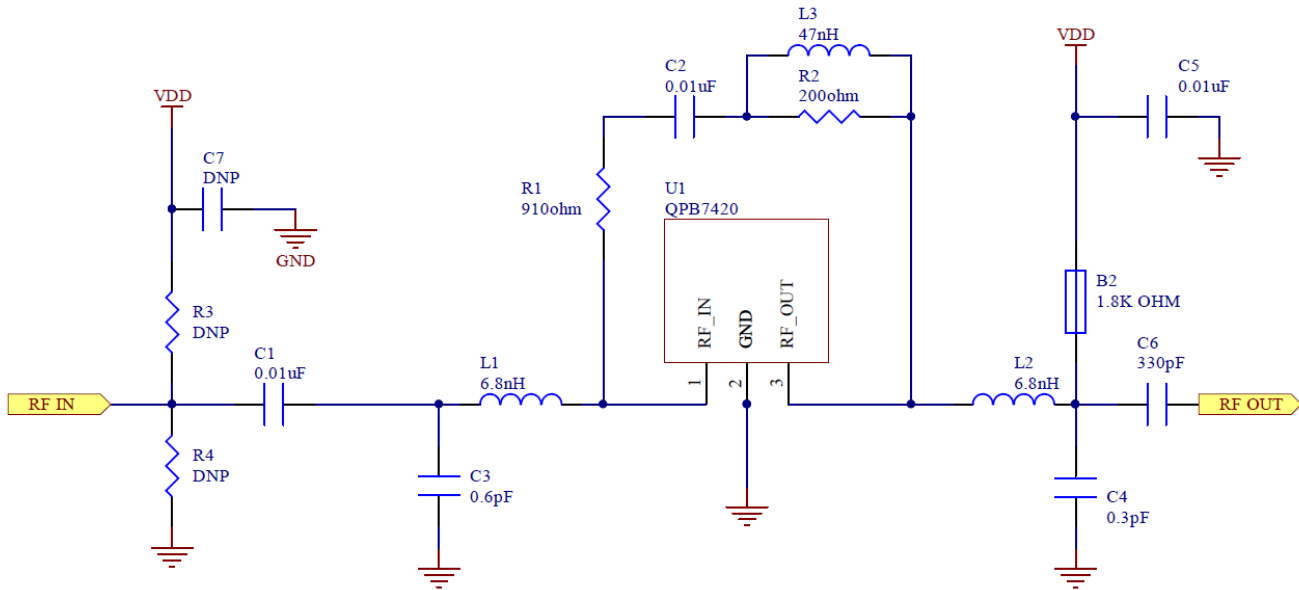

Notes:

1. C3/L1 tunes input return loss.
2. L2/C4 tunes output return loss with some contribution from C6.
3. The feedback network is composed of R1 and R2, with C3 being a DC block and L3 providing high end peaking. The ratio of R1 to R2 controls flatness and tilt while the total feedback resistance affects device gain.
4. B2 provides the bias path with RF isolation from the RF output path.
5. R3 and R4 are options that may be added from the input to VDD or to ground to increase linearity or shed power, trading off degraded noise figure and return loss. Refer to Additional Application Data section below for further information.

Performance Data – 5 V

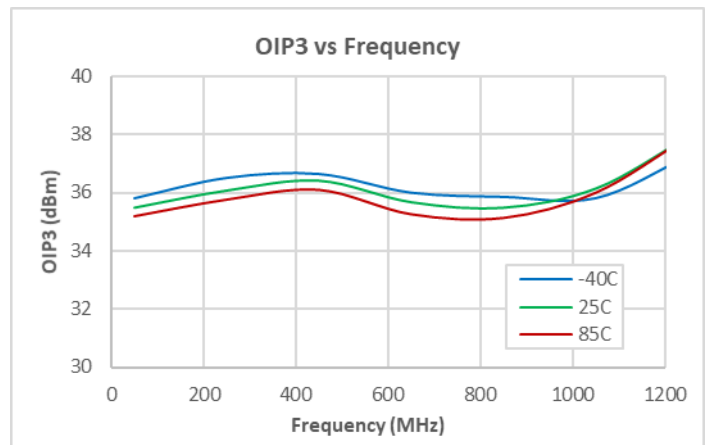
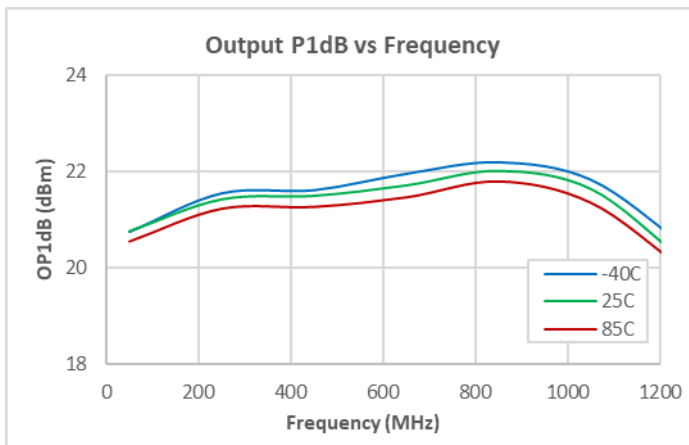
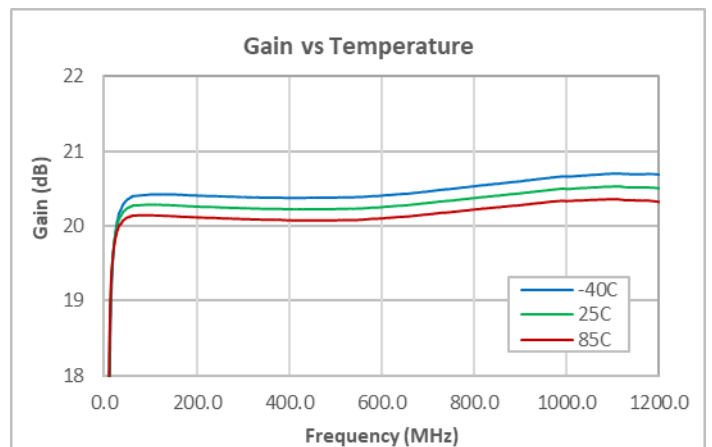
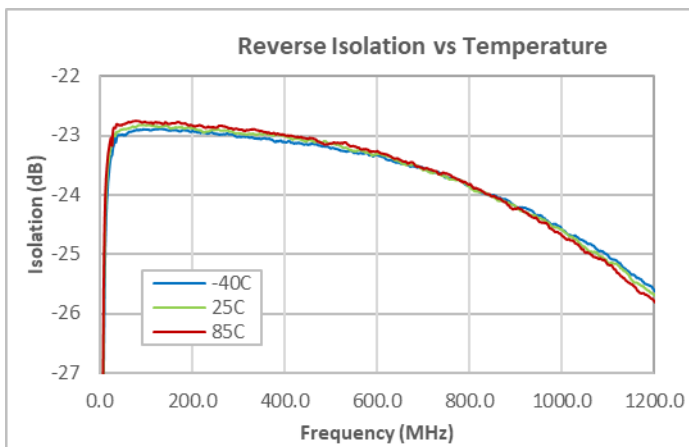
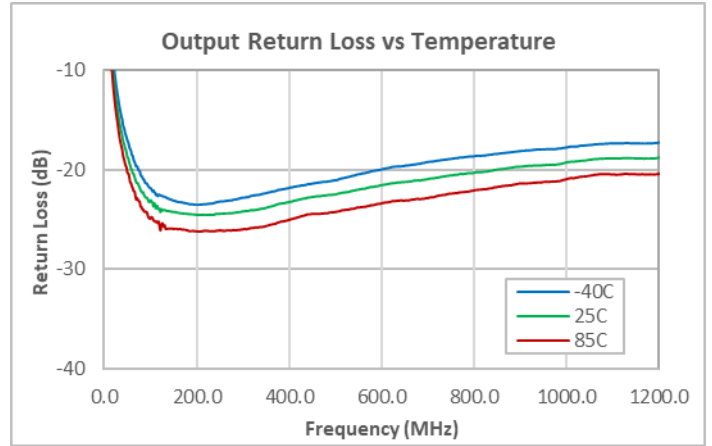
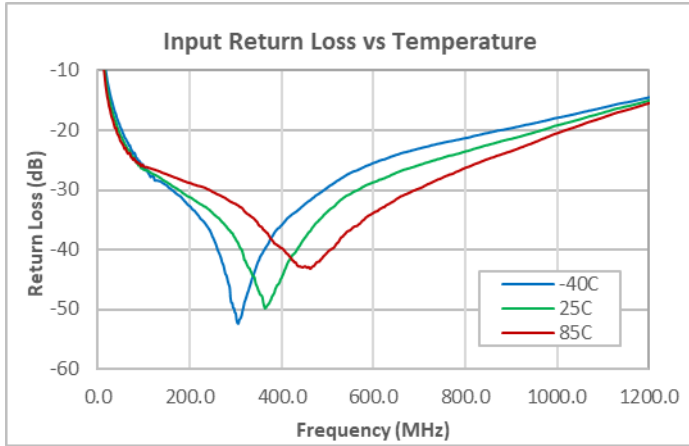

Notes:
(1) OIP3: 7 dBm/tone output

Performance Data – 5 V

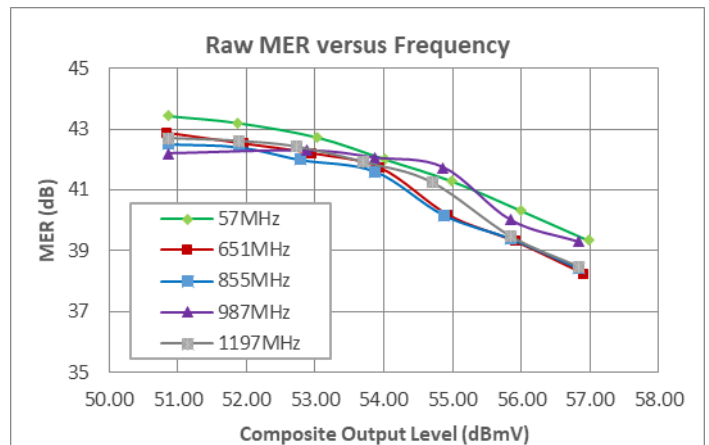
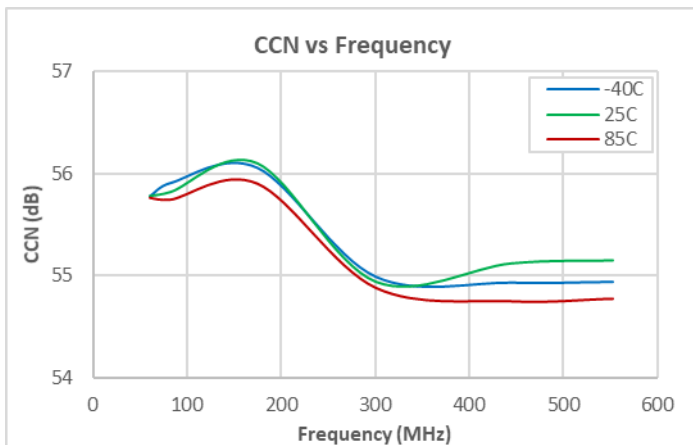
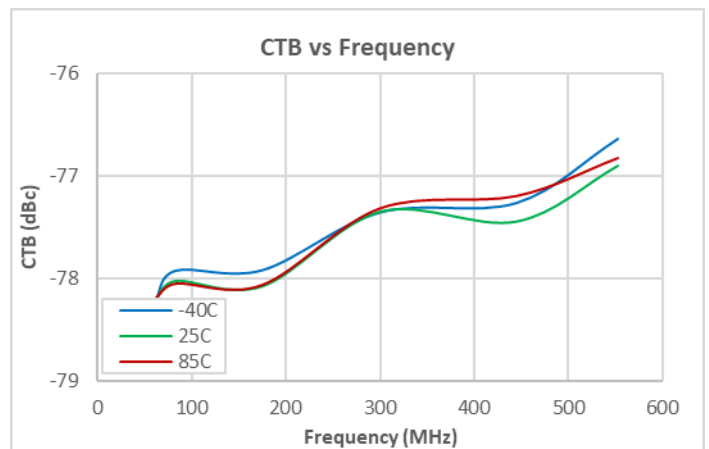
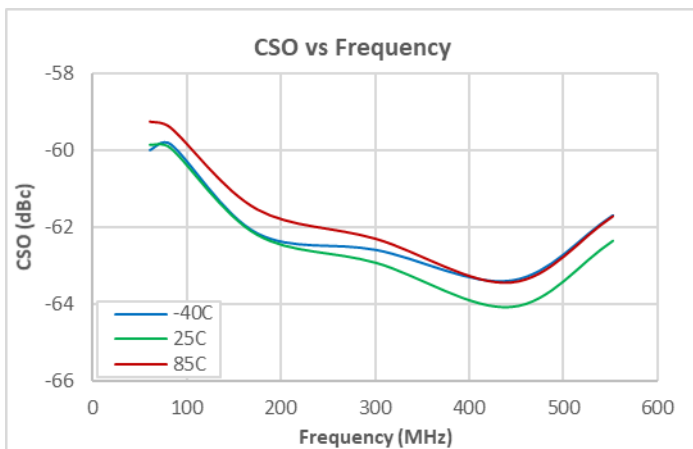
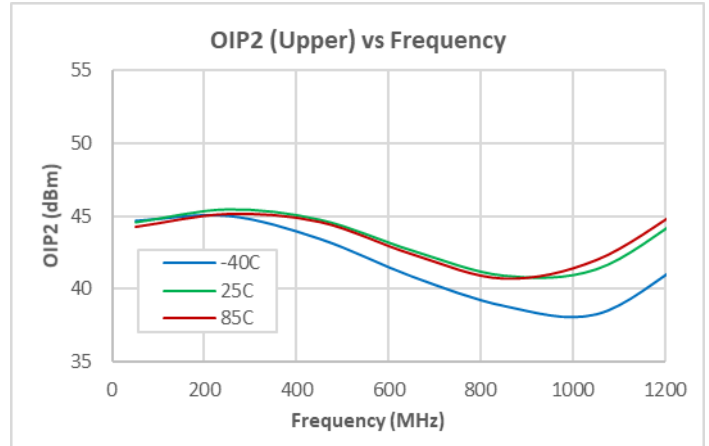
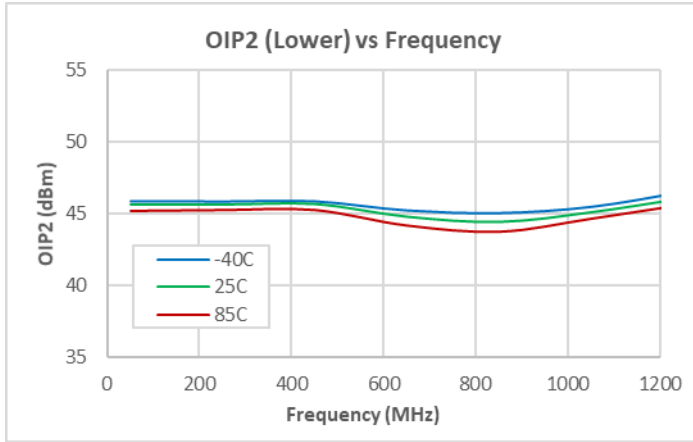

Notes:

- (1) OIP2: 7 dBm / tone output
- (2) CSO/CTB, CCN: 20 dBmV / ch output, 80 NTSC + 108 QAM, flat
- (3) MER: 190 QAM256 Channels, 57-1215MHz, ITU-T J.83, Annex B

Performance Data – 5 V

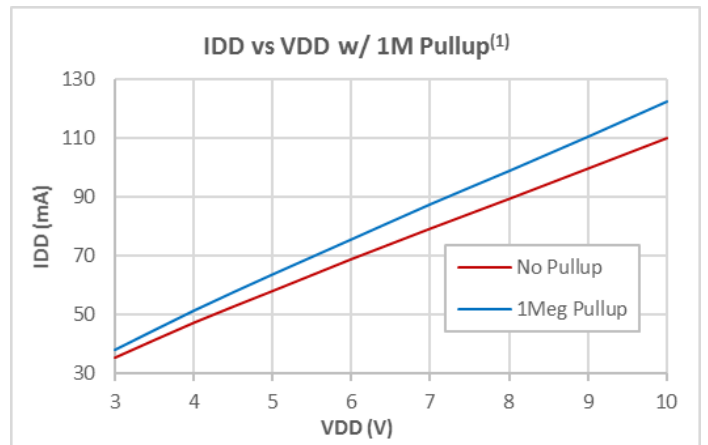
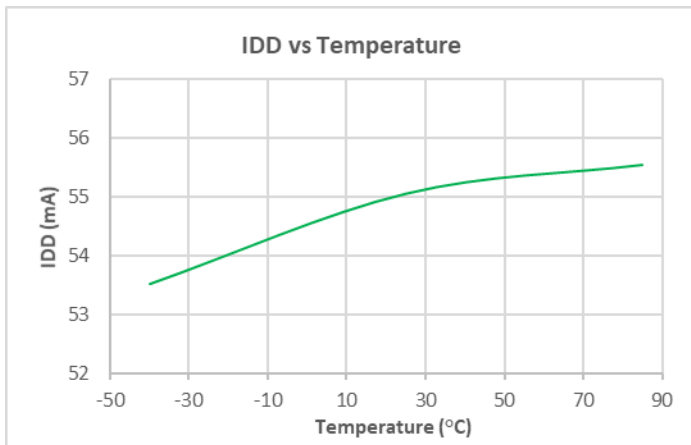
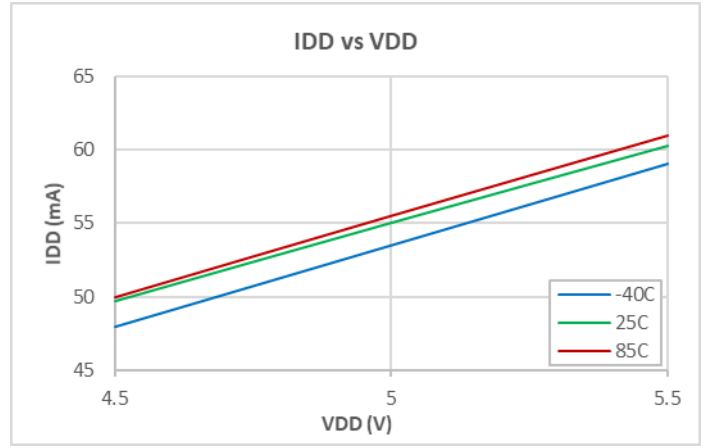
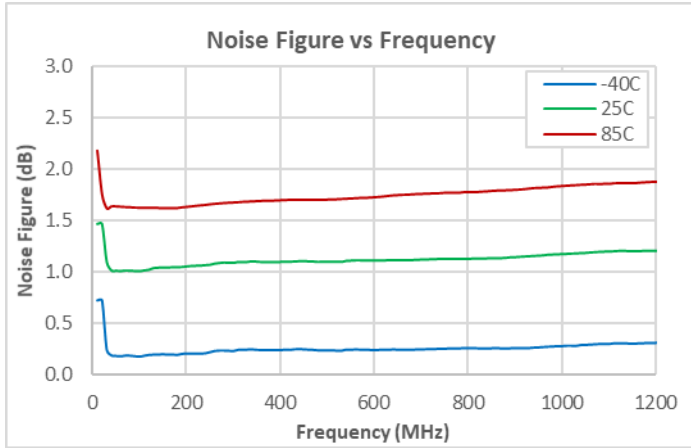

Notes:
(1) 1 MΩ Pullup installed in R3, 0Ω installed in R5. Refer to Evaluation Board Schematic on Pg 5.

Performance Data vs Supply Voltage

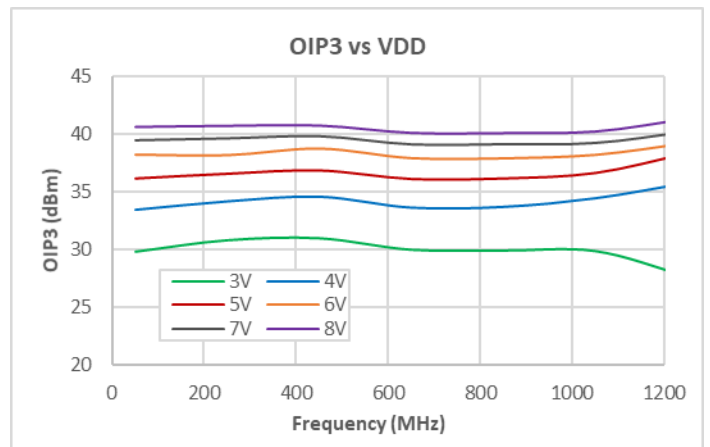
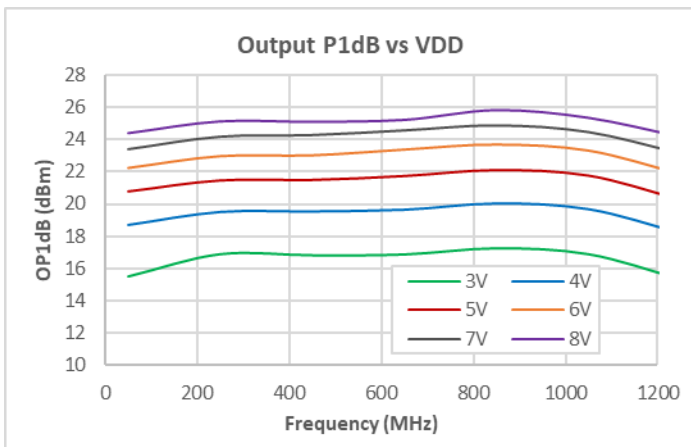
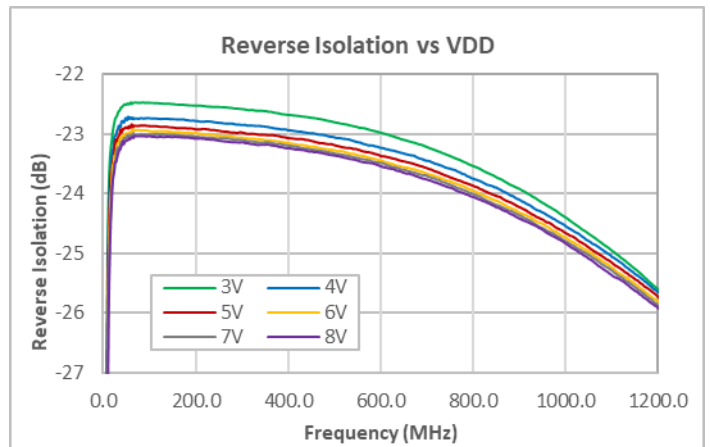
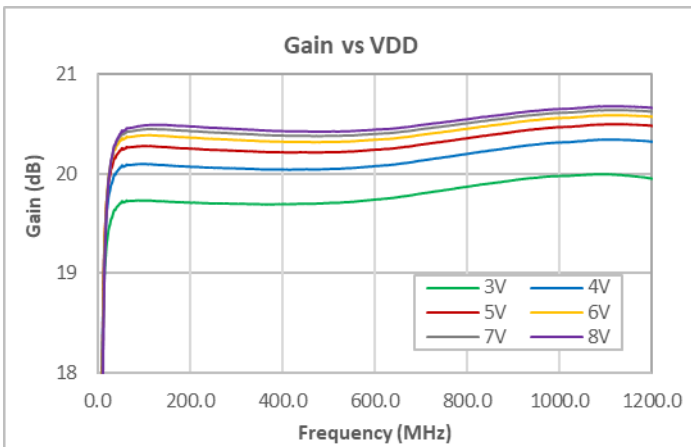
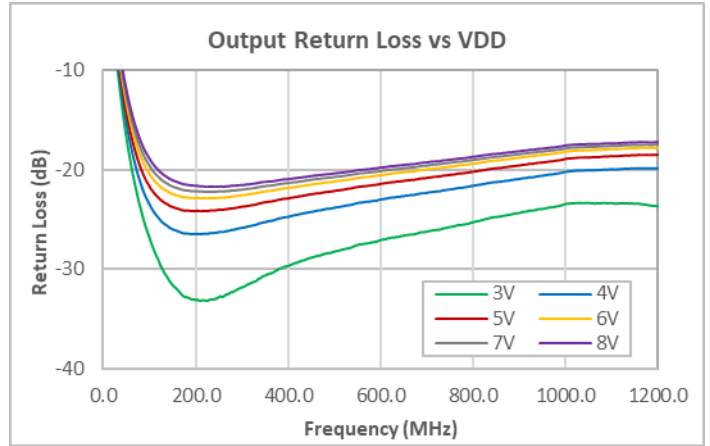
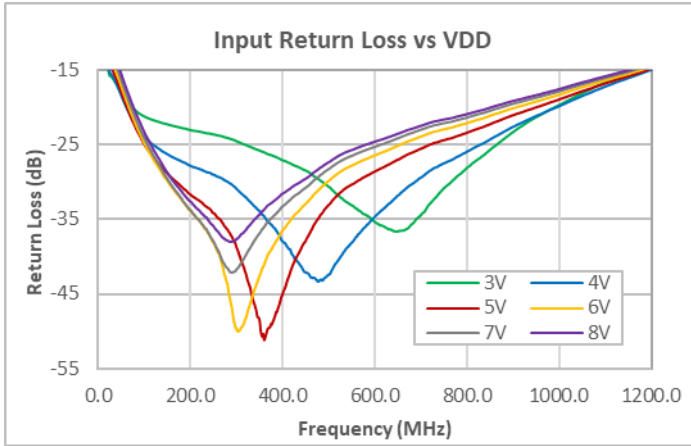

- Notes:
- (1) No pullup/pulldown resistor
 - (2) OIP3: 7 dBm / tone output

Performance Data vs Supply Voltage

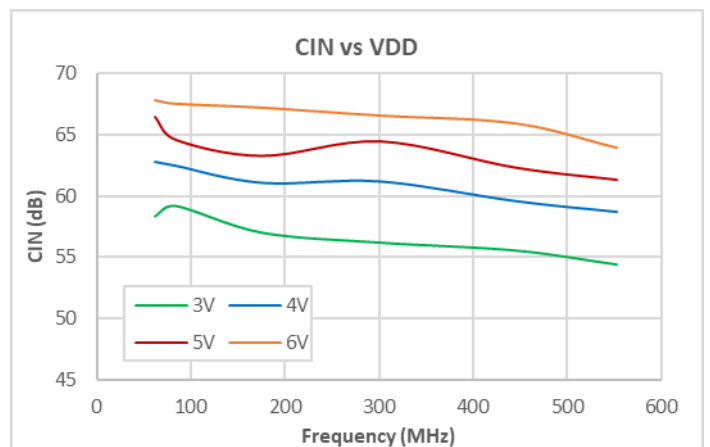
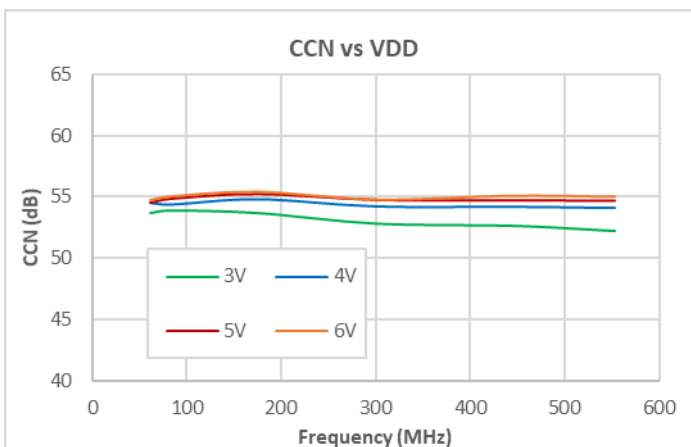
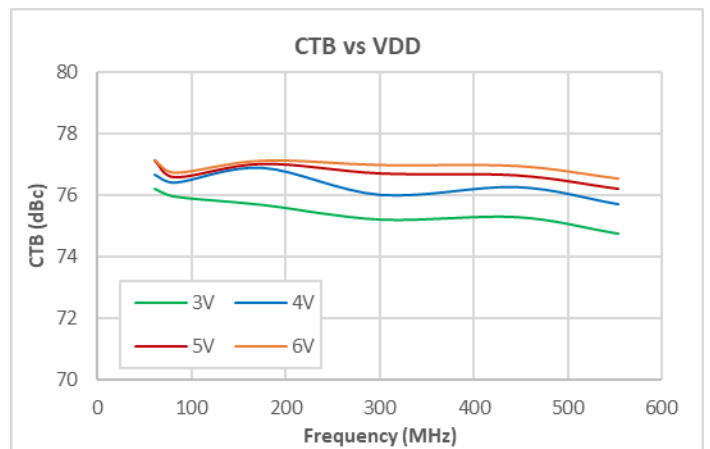
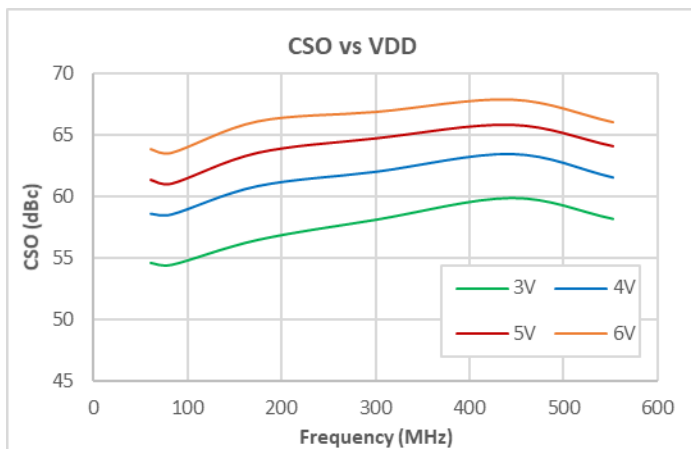
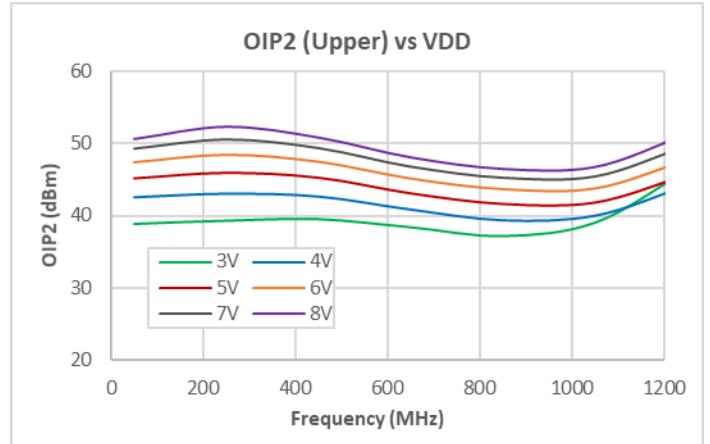
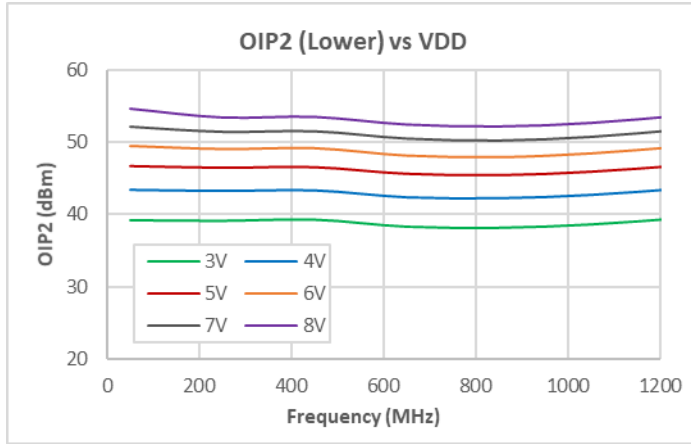

- Notes:
- (1) No pullup/pulldown resistor
 - (2) OIP2: 7 dBm/ tone output
 - (3) CSO/CTB, CCN: 20 dBmV / ch output, 80 NTSC + 108 QAM, flat

Performance Data vs Supply Voltage

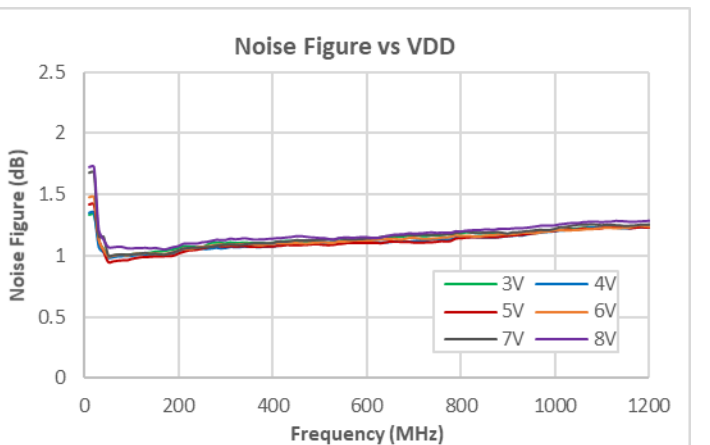
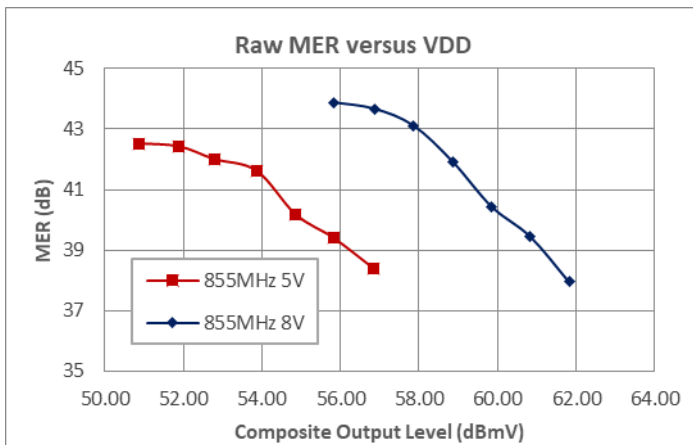
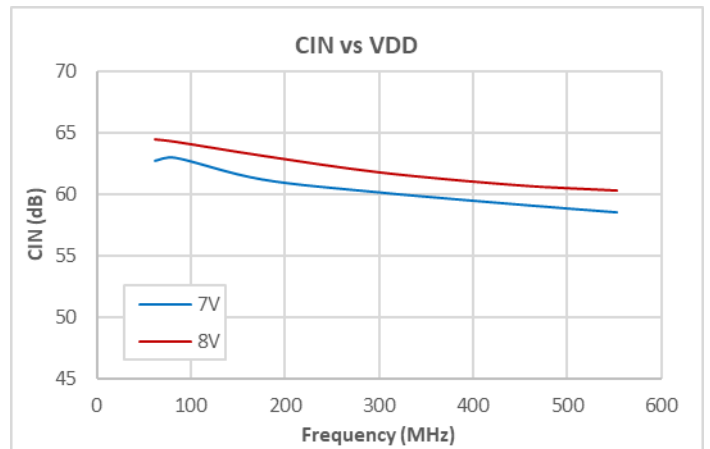
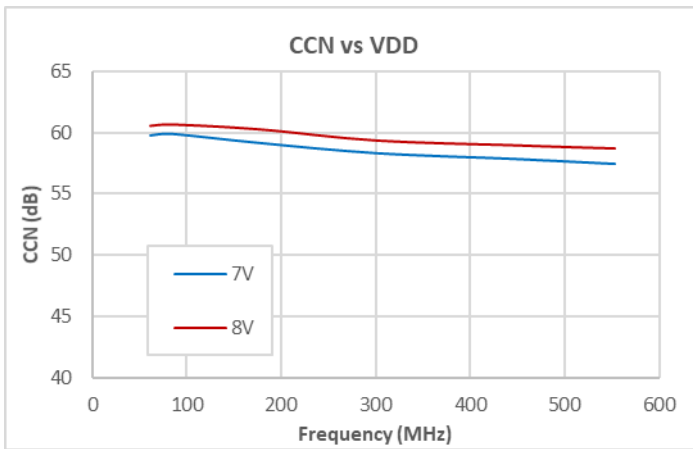
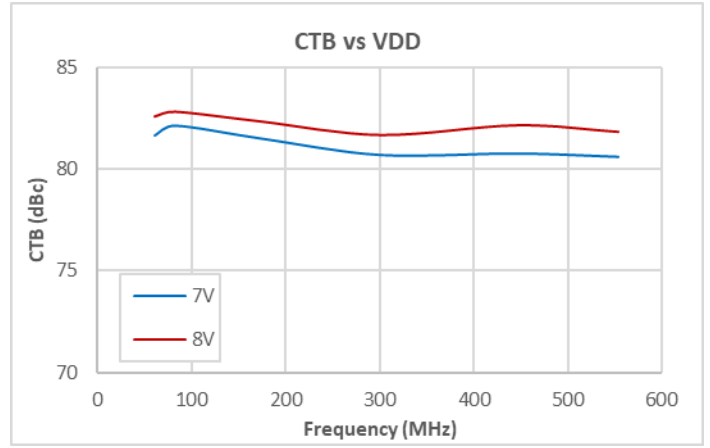
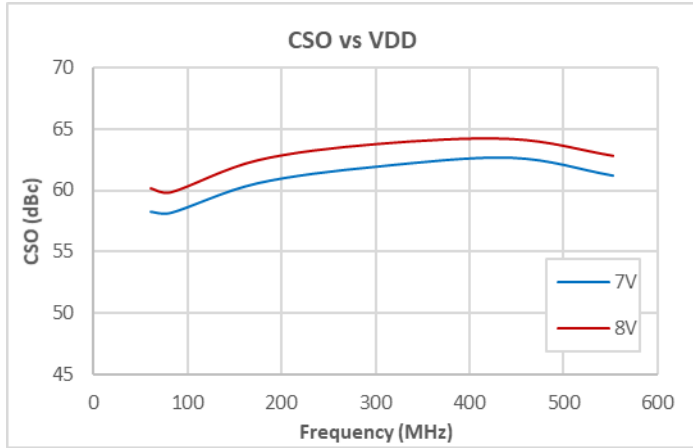

Notes:

- (1) No pullup/pulldown resistor
- (2) CSO/CTB, CCN: 28 dBmV / ch output, 80 NTSC + 108 QAM, flat
- (3) MER: 190 QAM256 Channels, 57-1215MHz, ITU-T J.83, Annex B

Additional Application Data; Pullup Resistor Options

Table 1. Pullup/Pulldown Bias Resistor Options

Bias Current vs R3/R4				
R3 Pullup (ohms)	R4 Pulldown (ohms)	IDD (8V) (mA)	IDD (5V) (mA)	IDD (3V) (mA)
100K	Open	164.0*	103.4	56.6
221K	Open	121.8	75.4	41.8
499K	Open	99.0	61.6	34.8
1M	Open	90.6	56.6	32.1
Open	Open	81.2	51.2	29.2
Open	1M	80.2	50.4	28.7
Open	100K	71.5	43.5	23.9

* Exceeds Abs. Max. Current for device

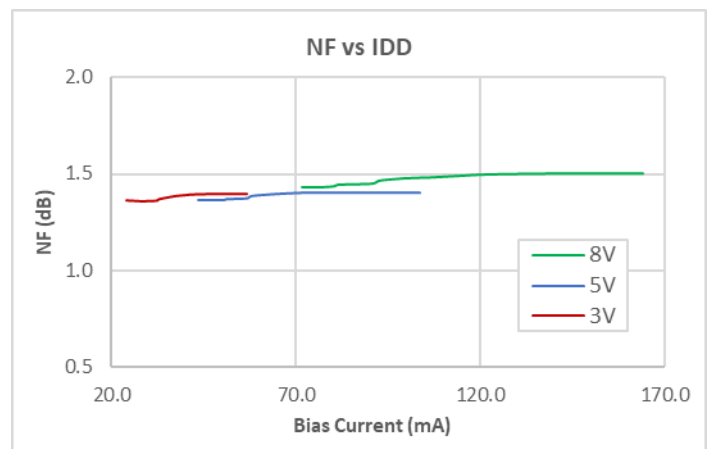
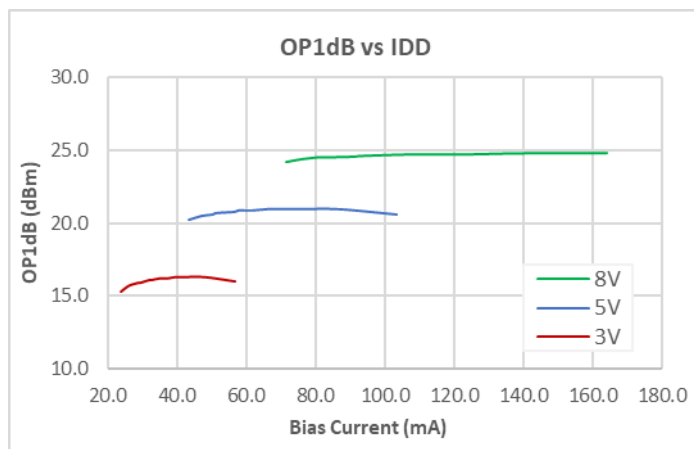
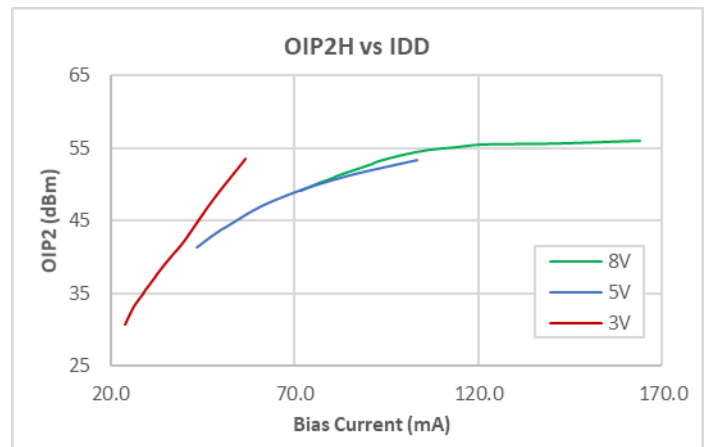
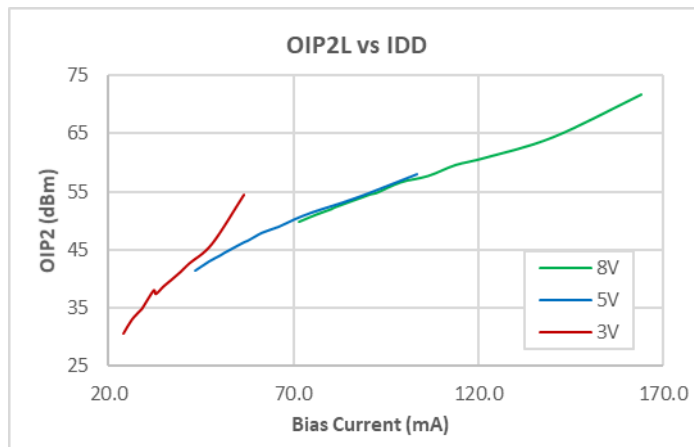
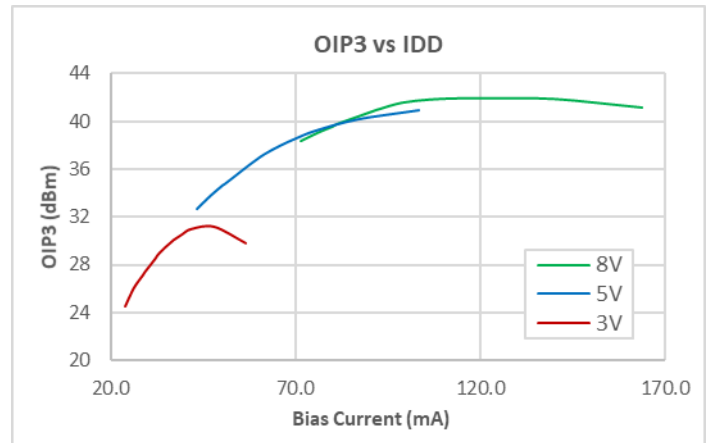
Notes:

- (1) VDD as noted. 75ohm system.
- (2) OIP3, OIP2: 225MHz, 325MHz, 7 dBm/tone output. VDD as noted
- (3) OP1dB, NF: 225MHz

Additional Application Data; Pullup Resistor Options

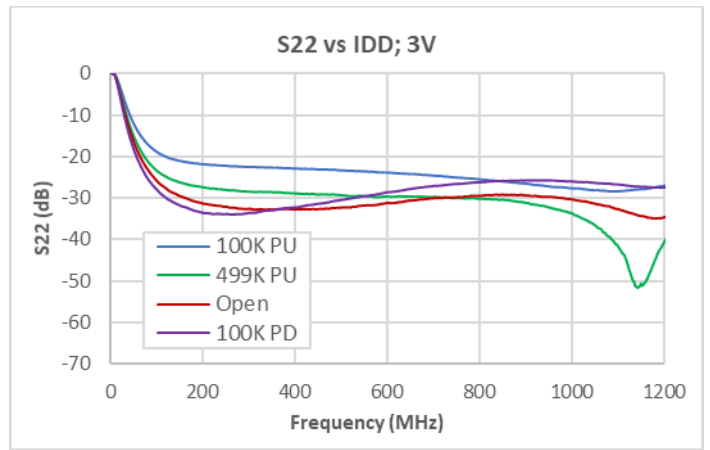
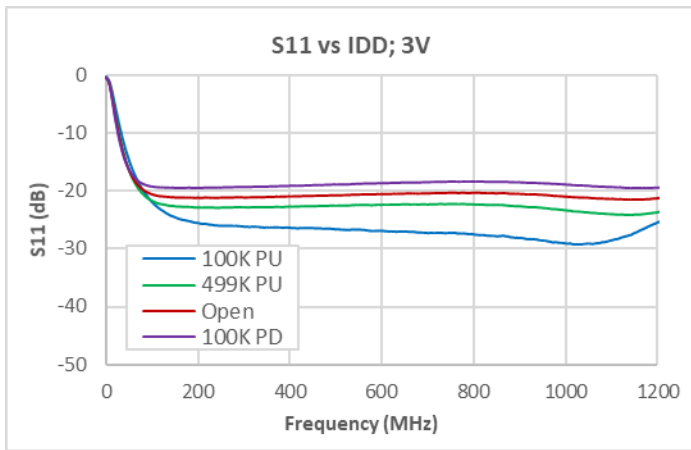
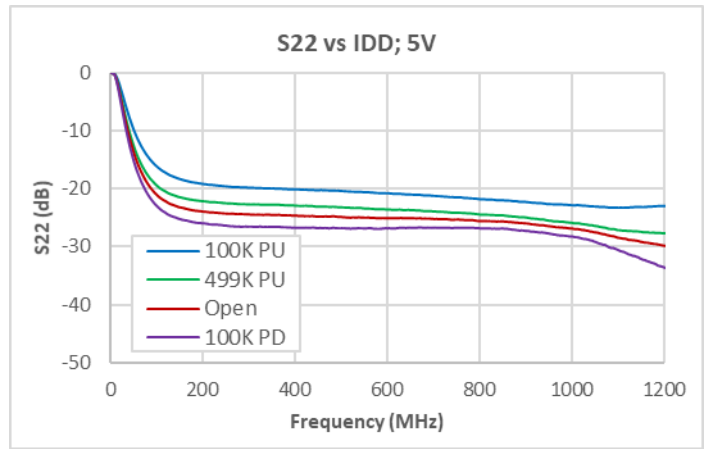
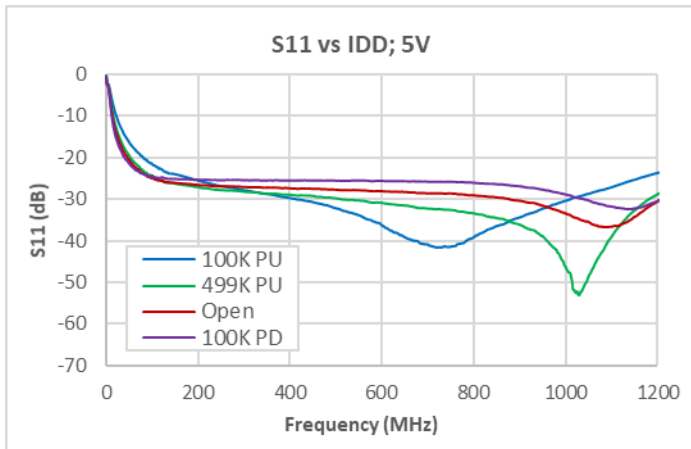
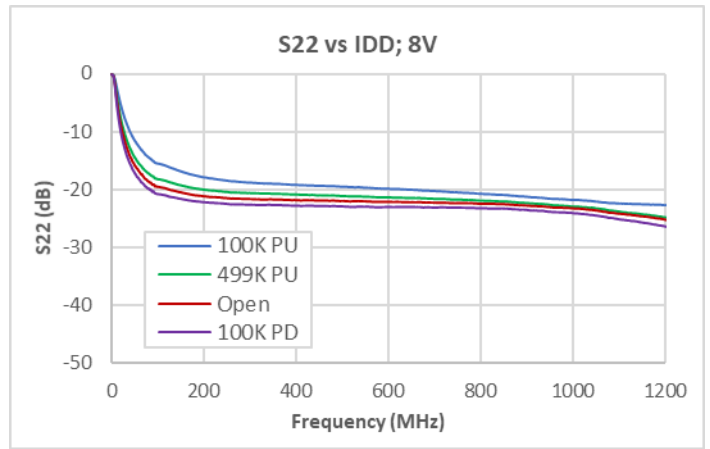
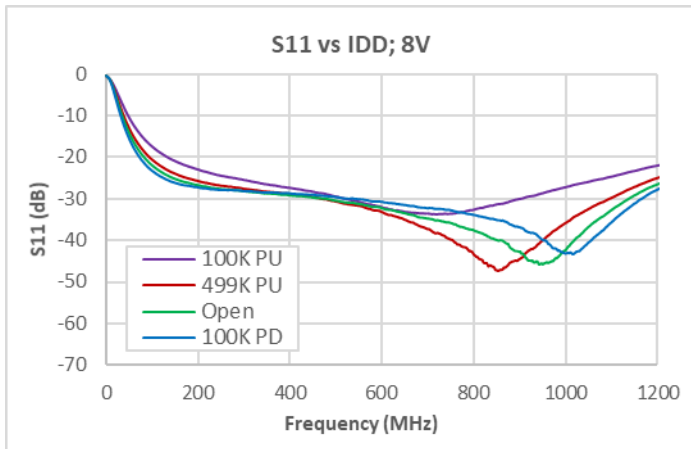

Notes:
 (1) VDD as noted. 75ohm system

Additional Application Data; Pullup Resistor Options

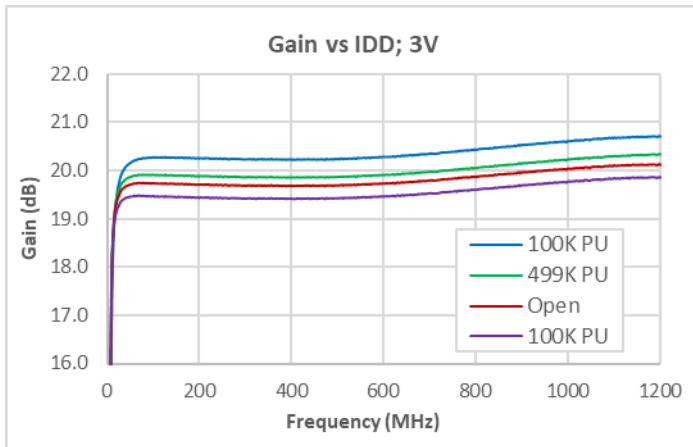
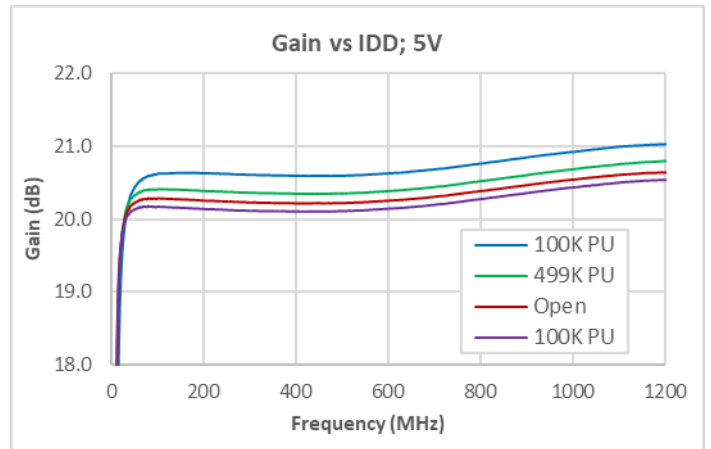
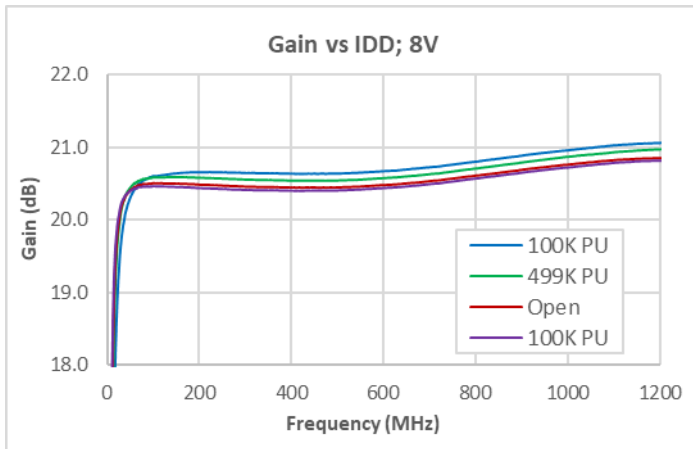

Notes:
 (1) VDD as noted. 75ohm system

Pin Configuration and Description

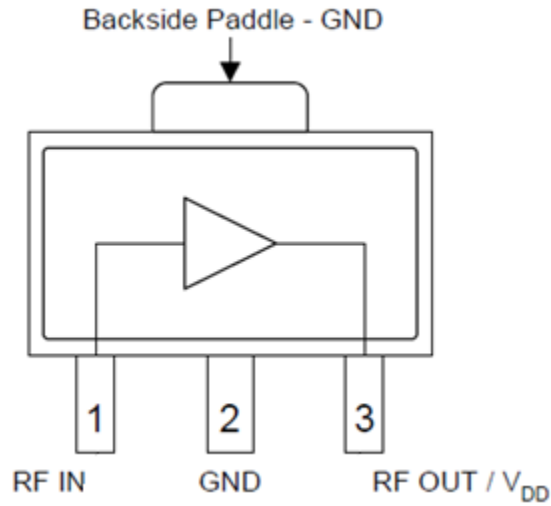

Top View

Pin Number	Label	Description
1	RF IN	RF Input, DC blocking capacitor required
2	GND	Internally Not Connected
3	RF OUT / VDD	RF Output – VDD bias choke required
Backside Paddle	GND	Ground. Use recommended via pattern to minimize inductance and thermal resistance. See PCB Mounting Pattern for suggested footprint.

Package Outline

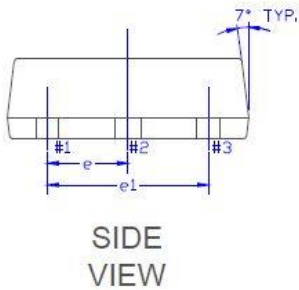
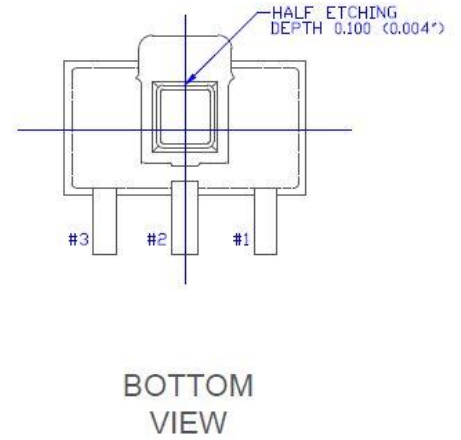
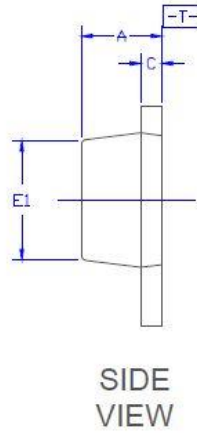
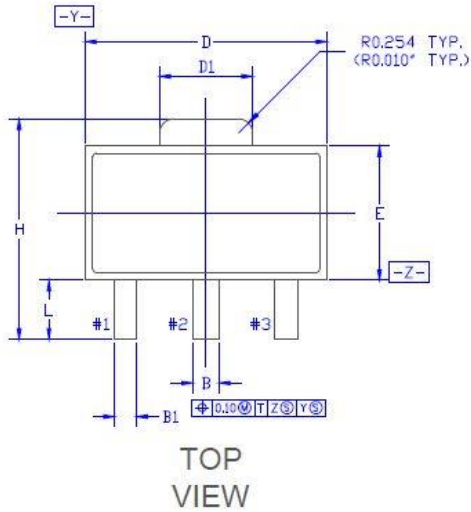

DIMENSIONS	Common					
	DIMENSIONS MILLIMETER			DIMENSIONS INCH		
	MIN.	NOM.	MAX.	MIN.	NOM.	MAX.
A	1.40	1.50	1.60	0.055	0.059	0.063
B	0.44	0.50	0.56	0.017	0.020	0.022
B1	0.36	0.42	0.48	0.014	0.017	0.019
C	0.35	0.40	0.44	0.014	0.016	0.017
D	4.40	4.50	4.60	0.173	0.177	0.181
D1	1.62	1.73	1.83	0.064	0.068	0.072
E	2.30	2.50	2.60	0.091	0.098	0.102
E1	2.13	2.20	2.29	0.084	0.087	0.090
e	1.50 BSC.			0.059 BSC.		
e1	3.00 BSC.			0.118 BSC.		
H	3.95	4.10	4.25	0.156	0.161	0.167
L	0.90	1.10	1.20	0.035	0.043	0.047

Package Marking

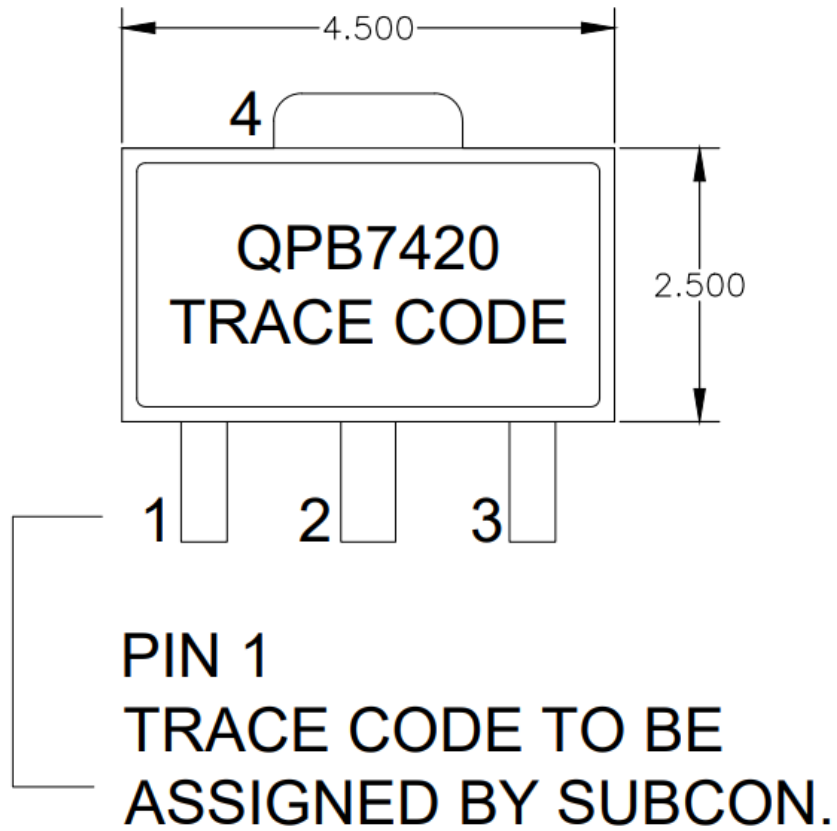

Recommended Mounting Pattern

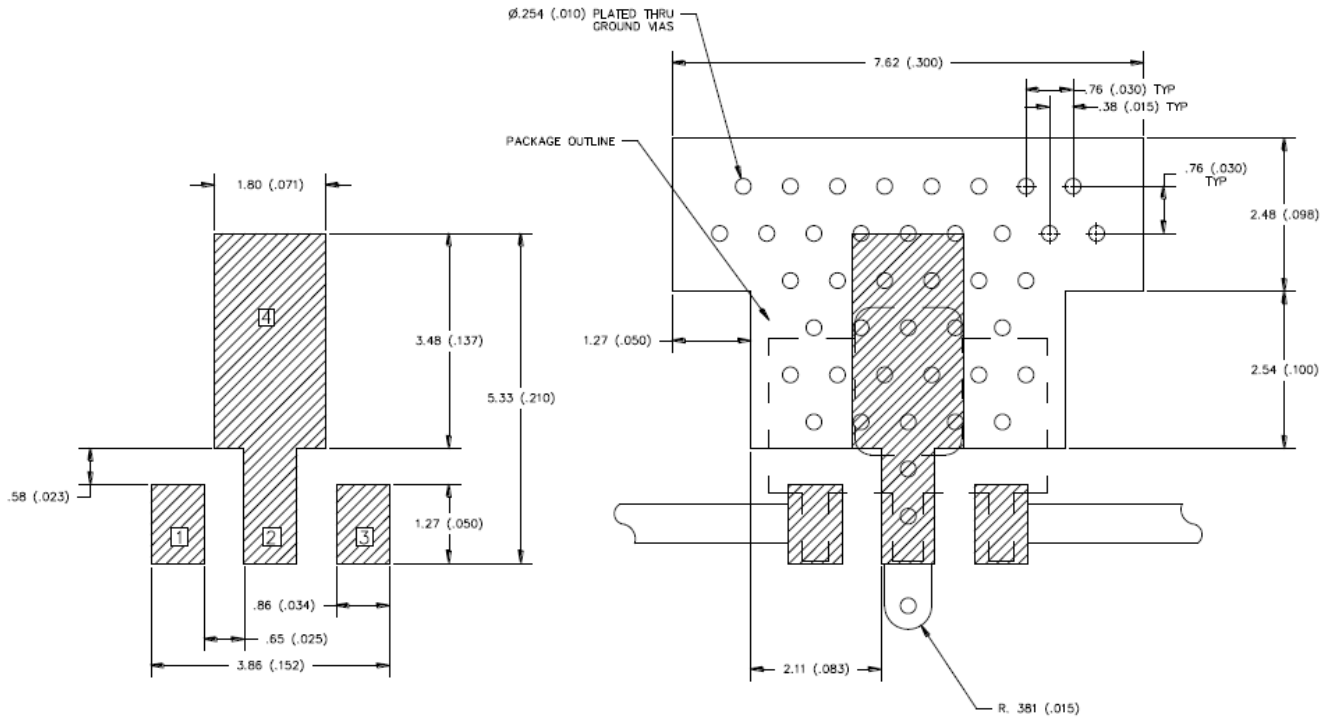

Notes:

- (1) Ground/thermal vias are critical for the proper performance of this device. Vias should use a .35 mm (#80/.0135") diameter drill and have a final, plated thru diameter of 0.25 mm (0.010").
- (2) Add as much copper as possible to inner and outer layers near the part to ensure optimal thermal performance.
- (3) RF trace width depends upon the PC board material and construction.
- (4) All dimensions are in millimeters (inches). Angles are in degrees.

Handling Precautions

Parameter	Rating	Standard
ESD – Human Body Model (HBM)	Class 1C (2000V)	ESDA / JEDEC JS-001-2012
ESD – Charged Device Model (CDM)	Class C3 (>1000V)	JEDEC JESD22-C101F
MSL – Moisture Sensitivity Level	Level 3	IPC/JEDEC J-STD-020



Caution!
ESD-Sensitive Device

Solderability

Compatible with both lead-free (260 °C max. reflow temp.) and tin/lead (245 °C max. reflow temp.) soldering processes. Solder profiles available upon request.

Contact plating: NiPdAu

RoHS Compliance

This part is compliant with 2011/65/EU RoHS directive (Restrictions on the Use of Certain Hazardous Substances in Electrical and Electronic Equipment) as amended by Directive 2015/863/EU.

This product also has the following attributes:

- Lead Free
- Halogen Free (Chlorine, Bromine)
- Antimony Free
- TBBP-A (C₁₅H₁₂Br₄O₂) Free
- PFOS Free
- SVHC Free



Contact Information

For the latest specifications, additional product information, worldwide sales and distribution locations:

Tel: 1-844-890-8163

Web: www.qorvo.com

Email: customer.support@qorvo.com

Important Notice

The information contained in this Data Sheet and any associated documents (“Data Sheet Information”) is believed to be reliable; however, Qorvo makes no warranties regarding the Data Sheet Information and assumes no responsibility or liability whatsoever for the use of said information. All Data Sheet Information is subject to change without notice. Customers should obtain and verify the latest relevant Data Sheet Information before placing orders for Qorvo® products. Data Sheet Information or the use thereof does not grant, explicitly, implicitly or otherwise any rights or licenses to any third party with respect to patents or any other intellectual property whether with regard to such Data Sheet Information itself or anything described by such information.

DATA SHEET INFORMATION DOES NOT CONSTITUTE A WARRANTY WITH RESPECT TO THE PRODUCTS DESCRIBED HEREIN, AND QORVO HEREBY DISCLAIMS ANY AND ALL WARRANTIES WITH RESPECT TO SUCH PRODUCTS WHETHER EXPRESS OR IMPLIED BY LAW, COURSE OF DEALING, COURSE OF PERFORMANCE, USAGE OF TRADE OR OTHERWISE, INCLUDING THE IMPLIED WARRANTIES OF MERCHANTABILITY AND FITNESS FOR A PARTICULAR PURPOSE. Without limiting the generality of the foregoing, Qorvo® products are not warranted or authorized for use as critical components in medical, life-saving, or life-sustaining applications, or other applications where a failure would reasonably be expected to cause severe personal injury or death. Applications described in the Data Sheet Information are for illustrative purposes only. Customers are responsible for validating that a particular product described in the Data Sheet Information is suitable for use in a particular application.

© 2021 Qorvo US, Inc. All rights reserved. This document is subject to copyright laws in various jurisdictions worldwide and may not be reproduced or distributed, in whole or in part, without the express written consent of Qorvo US, Inc. | QORVO® is a registered trademark of Qorvo US, Inc.

X-ON Electronics

Largest Supplier of Electrical and Electronic Components

Click to view similar products for [RF Amplifier](#) category:

Click to view products by [Qorvo](#) manufacturer:

Other Similar products are found below :

[A82-1](#) [BGA622H6820XTSA1](#) [BGA 728L7 E6327](#) [BGB719N7ESDE6327XTMA1](#) [HMC397-SX](#) [HMC405](#) [HMC561-SX](#) [HMC8120-SX](#)
[HMC8121-SX](#) [HMC-ALH382-SX](#) [HMC-ALH476-SX](#) [SE2433T-R](#) [SMA3101-TL-E](#) [SMA39](#) [A66-1](#) [A66-3](#) [A67-1](#) [A81-2](#) [LX5535LQ](#)
[LX5540LL](#) [MAAM02350](#) [HMC3653LP3BETR](#) [HMC549MS8GETR](#) [HMC-ALH435-SX](#) [SMA101](#) [SMA32](#) [SMA411](#) [SMA531](#)
[SST12LP19E-QX6E](#) [WPM0510A](#) [HMC5929LS6TR](#) [HMC5879LS7TR](#) [HMC1126](#) [HMC1087F10](#) [HMC1086](#) [HMC1016](#) [SMA1212](#)
[MAX2689EWS+T](#) [MAAMSS0041TR](#) [MAAM37000-A1G](#) [LTC6430AIUF-15#PBF](#) [SMA70-2](#) [SMA4011](#) [A231](#) [HMC-AUH232](#) [LX5511LQ](#)
[LX5511LQ-TR](#) [HMC7441-SX](#) [HMC-ALH310](#) [XD1001-BD-000V](#)