

Product Overview

The QPB7432 is a 47–1218 MHz High Gain, Low EIN, Single ended RF Optical Receiver for FTTH PON applications. It is a technology leader with an optical input range from -18 dBm to 0 dBm. The QPB7432, with recommended external control circuitry, provides automatic gain control to maintain a constant +14 dBmV to +20 dBmV/channel output to insure consistent video quality. It runs on a single +5 V supply eliminating the need for an extra ONT supply.



3-pin SOT-89 Package

Functional Block Diagram

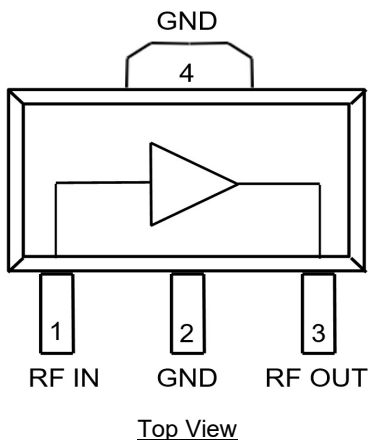

Ordering Information

Part Number	Description
QPB7432SQ	Sample bag with 25 pieces
QPB7432SR	7" Reel with 100 pieces
QPB7432TR13	13" Reel with 2500 pieces
QPB7432PCK	Optical Receiver Reference design with 5 piece sample bag
QPB7432PCK-2	75 Ω EVB with 5 piece sample bag
QPB7432PCK-3	Optical-to-RF EVB with 5 piece sample Bag

Key Features

- Optical Input Range: 0 dBm to -18 dBm
- High Gain: >30 dB gain at 550 MHz
- Efficient Power Consumption: 550 mW for +5 V
- Low Noise: 3.5 pA / $\sqrt{\text{Hz}}$ Equivalent Input Noise Current (EINC)
- High Linearity: +40 dBm OIP3 and +48 dBm OIP2 at 550 MHz
- 47 – 1218 MHz Operational Bandwidth
- 30 dB AGC Range with Recommended External Control Circuitry
- Convenient SOT – 89 Package
- RoHS Compliant

Applications

- FTTH xPON
- DOCSIS 3.1
- Head End CMTS Equipment
- Cable Modem and Set Top Box
- Optical Node
- Low Noise, High Gain Amplifier for Active Off-Air/TV Antenna

Absolute Maximum Ratings

Parameter	Rating
Supply Voltage (V _{DD})	+6 V
Supply Current (I _{DD})	392 mA
Storage Temperature Range	-40 to +150 °C
Operating Temperature Range	-40 to +85°C
Maximum Junction Temperature	+150 °C
Maximum RF Input Power	-10 dBm

Exceeding any one or a combination of the Absolute Maximum Rating conditions may cause permanent damage to the device. Extended application of Absolute Maximum Rating conditions to the device may reduce device reliability.

Optical Input Requirements

Parameter	Unit	Min	Typical	Max
Optical Input Power	dBm	-18		0
Optical Modulation Index (OMI)	% / Ch (79ch)		3.5	
1550 nm PIN Responsivity	mA/mW		0.95	
1550 nm PIN Capacitance	pF		0.35	

Optical to Electrical Receiver Application Specifications

Parameter	Condition ⁽¹⁾	Min	Typ	Max	Unit
Supply Current (I _{DD})	Steady state operation		160		mA
Frequency Range		47		1218	MHz
Optical Gain	At 550MHz. O/E gain is defined by $20 \cdot \log(Zt/75)$		44.5		dB
Gain Flatness			±1.5		dB
Tilt	Linear tilt from 45 – 1218 MHz; higher tilt can be achieved by changing components		6		dB
Equivalent Input Noise			3.5		pA / √Hz
RF Output Level at 547.25 MHz	RF Output Level at 547.25 MHz		+14		dBmV/ch
	At 45 MHz		-17		dB
Output Return Loss	At 600 MHz		-15		dB
	At 1218 MHz		-18		dB
MER	90MHz to 850MHz, 0dB tilt, 96 channels, 8MHz spacing. ITU-T Annex A 256 QAM 6.952 Msymbols/s. OMI = 3.5%		32		dB
BER			2.0E-5		
Gain Control Range	Using suggested application circuit		30		dB

Notes:

- Typical performance at these conditions:
Temperature = +25 °C, V_{DD} = +5 V, Optical Input to Electrical RF Out - Receiver reference design

Schematic: Optical Receiver Application EVB – QPB7432PCK

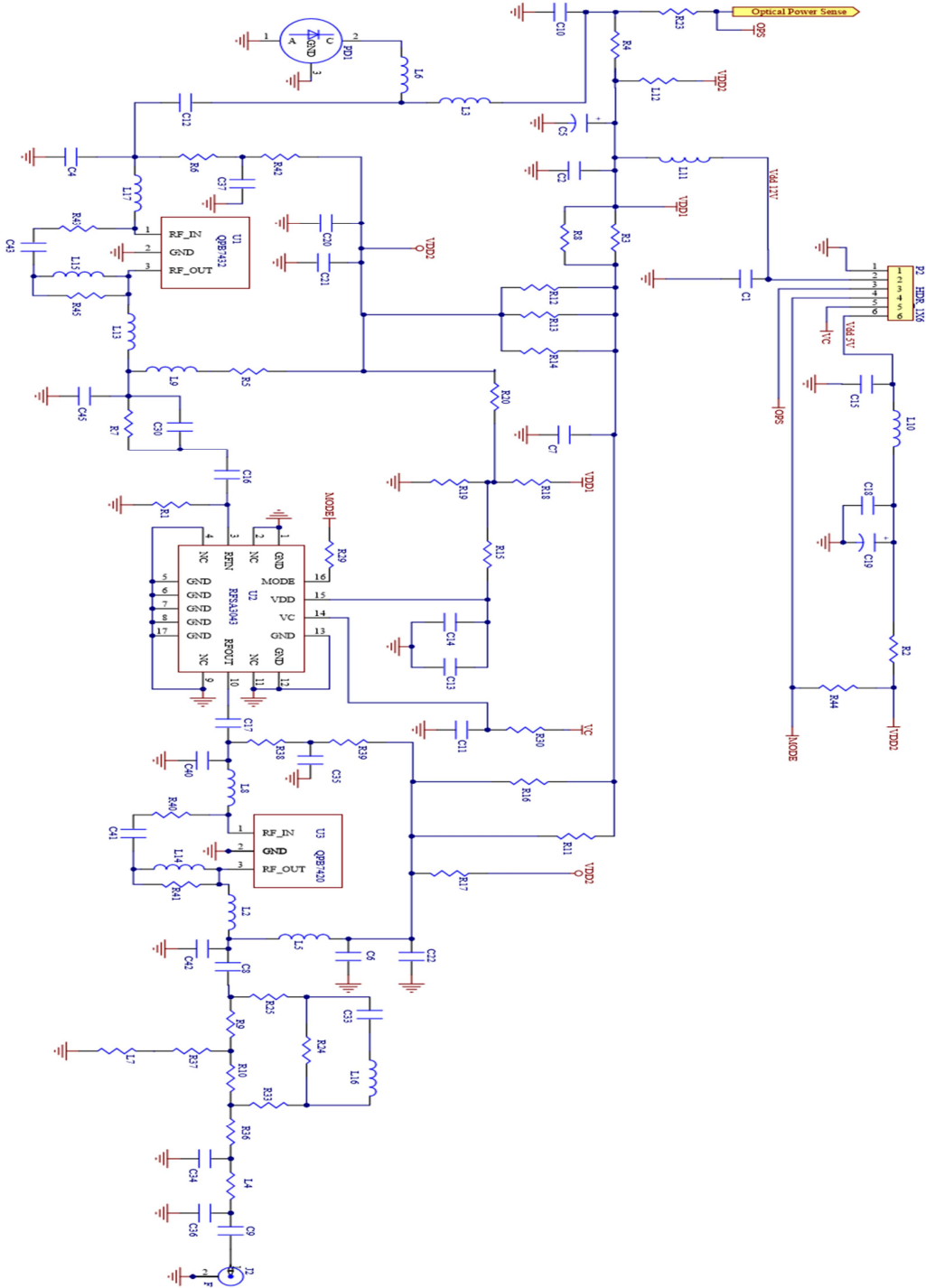

Bill of Materials: Optical Receiver Application EVB – QPB7432PCK

Designator	Description	Manufacturer	Part Number
U1	FTTH - Low EINC Optical Front End(5V,32dB)	Qorvo	QPB7432
U2	CATV Voltage Controlled Attenuator	Qorvo	RFSA3043
U3	CATV, FTTx LNA (5V, 50mA 20dB)	Qorvo	QPB7420
PCB BARE BOARD	PCB, QPB7432	TTM Technologies	287720
C21	CAP, 100 pF, 5%, 50V, C0G, 0402	Murata Electronics	GRM1555C1H101JA01D
C22, C17, C41	CAP, 100 pF, 5%, 50V, C0G, 0402	Murata Electronics	GRM155R71E103KA01D
C5, C19	CAP, 10 uF, 10%, 16V, TANT-B	AVX Asia Limited	TAJB106K016RNJ
C40	CAP, 0.6 pF, ±0.05pF, 50V, HI-Q, 0402	Murata Electronics	GJM1555C1HR60WB01D
C6, C9, C10, C11, C12, C13, C14, C20, C37, C43	CAP, 1000 pF, 10%, 50V, STD, 0402	Taiyo Yuden	UMK105B7102KV-F
C16	CAP, 150 pF, 5%, 50V, 0402	Murata Electronics	GRM1555C1H151JA01D
C8	CAP, 330 pF, 10%, 50V, 0402	Murata Electronics	GRM155R71H331KA01E
C1, C2, C7, C15, C18	CAP, 100 nF, 10%, 16V, 0603	Murata Electronics	GRM188R71C104KA01D
C42	CAP, 0.3 pF, 0.1pF, 50V, COG, 0402	Murata Electronics	GJM1555C1HR30BB01D
R9	RES, 56 Ω, 5%, 1/10W, 0402	Panasonic Industrial	ERJ-2GEJ560X
L4, L7, R10, R36, R20, R42	RES, 0 Ω, 5%, 1/10W, 0402	Kamaya, Inc	RMC1/16SJPTH
R7	RES, 22 Ω, 5%, 1/16W, 0402	Kamaya, Inc	RMC1/16S-220JTH
R15, R44	RES, 100 Ω, 5%, 1/16W, 0402	Kamaya, Inc	RMC1/16S-101JTH
R1	RES, 330 Ω, 5%, 1/16W, 0402	Kamaya, Inc	RMC1/16S-331JTH
R6	RES, 1.5 MΩ, 5%, 1/16W, 0402	Kamaya, Inc	RMC1/16S-155JTH
R43, R45	RES, 3.92 KΩ, 1%, 1/16W, 0402	Panasonic Industrial	ERJ-2RKF3921X
R18, R23	RES, 10KΩ, 1%, 1/16W, 0402	Panasonic Industrial	ERJ-2RKF1002X
R40	RES, 910 Ω, 5%, 1/16W, 0402	Panasonic Industrial	ERJ-2GEJ911X
R3, R8	RES, 20 Ω, 5%, 1/4W, 1206	Panasonic Industrial	ERJ-8GEYJ200V
R4, R41	RES, 200 Ω, 5%, 1/16W, 0402	Panasonic Industrial	ERJ-2GEJ201
R19	RES, 6.8KΩ, 5%, 1/16W, 0402	Panasonic Industrial	ERJ-2GEJ682
R11, R12, R13, R14, R16	RES, 120 Ω, 5%, 1/4W, 1206	Panasonic Industrial	ERJ-8GEYJ121V
R2, R5, R17	RES, 0 Ω, 0603		
R29, R30	RES, 1 KΩ, 1%, 1/10W, 0402	KOA Europe GmbH	RK73H1ETTPL1001F
L14	IND, 47 nH, W/W, 0402	Coilcraft, Inc.	0402CS-47NXGRW
L13	IND, 12 nH, 5%, M/L, 0402	Murata Electronics	LQG15HN12NJ02D
L5, L9	IND, 1 uH, 5%, W/W, 0805	Coilcraft, Inc.	0805LS-102XJLC
L3	IND, 880 nH, 5%, W/W, 0805	Gowanda Electronics	CC0805-880J-2
L10	IND, 470 nH, 5%, W/W, 0805	Coilcraft, Inc.	0805LS-471XJRC
L2, L8, L17	IND, 6.8 nH, 2%, W/W, 0402	Murata Electronics	LQW15AN6N8G00D
L6	IND, 2.2 nH, +/-0.2nH, W/W, 0402	Murata Electronics	LQW15AN2N2C10D
HEAT SINK BLOCK	HEATSINK BLOCK, 1.5 X 2.0 IN	Shenzhen Minxingda	EEF-105441
L12	FER, BEAD, 1500 Ω, 500 mA, 0603	Murata Electronics	BLM18HE152SN1D
P2	CONN, HDR, ST, 6-PIN, 0.100"	SAMTEC INC.	TSW-106-07-G-S
J2	CONN, F FEM EDGE MOUNT, 75 Ω, 0.068"	Millimeter Wave Tech	MW-846-C-DD-75
SCREW2-56X3/16A,B,C,D	SCREW, 2-56X3/16", SOCKET HEAD	McMaster-Carr Supply	92196A076
R37	RES, 178 Ω, 1%, 0.05W, 0402	Vishay Amercias	M55342K11B178DSW
C4, C45, C30, C33, C34, C35, C36, L11, L15, L16, R24, R25, R33, R38, R39, PD1	NOT POPULATED ITEM-1		DUMMY PART

Layout Drawing: Optical Receiver Application EVB – QPB7432PCK

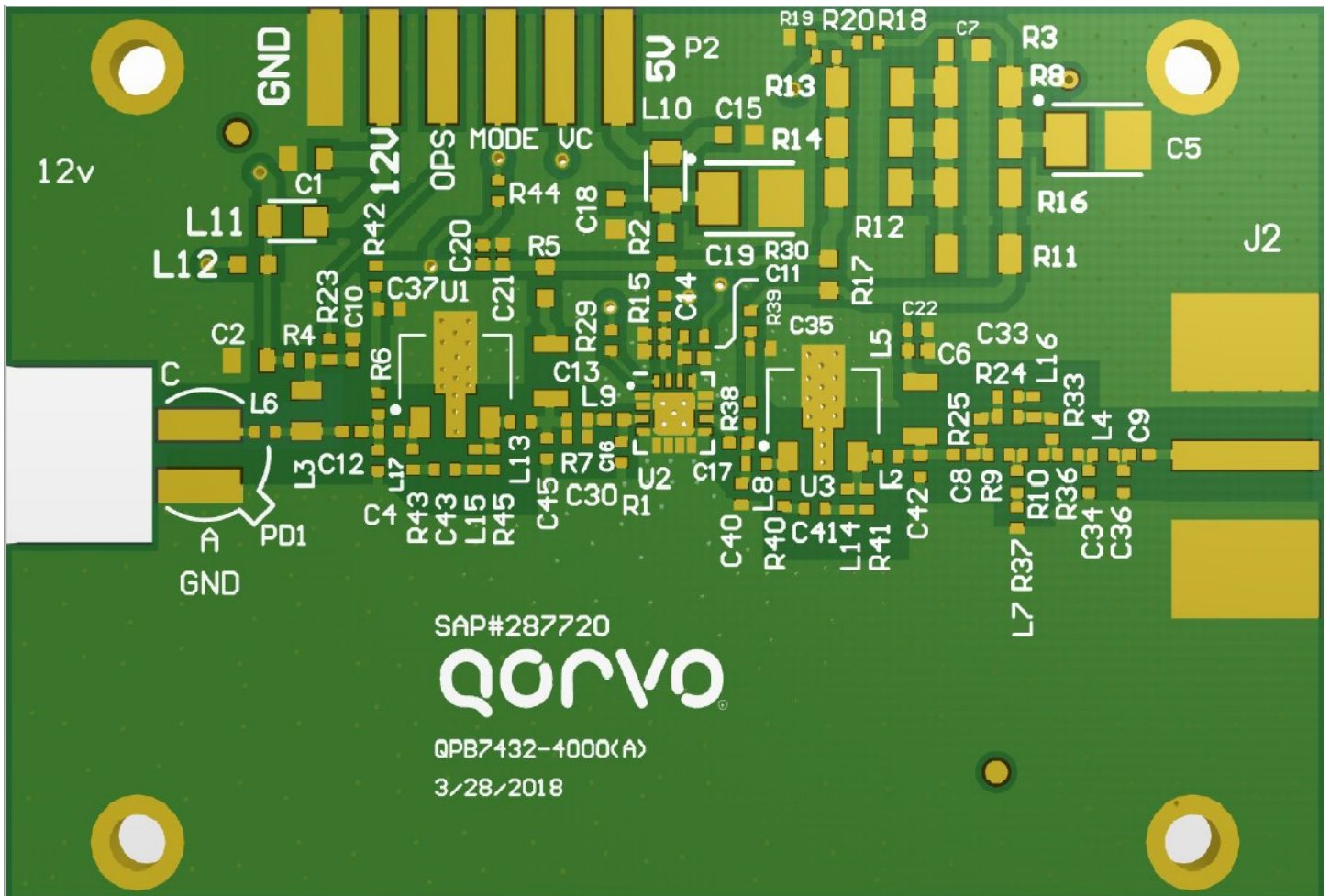

Typical Performance – Optical Receiver Application EVB – QPB7432PCK

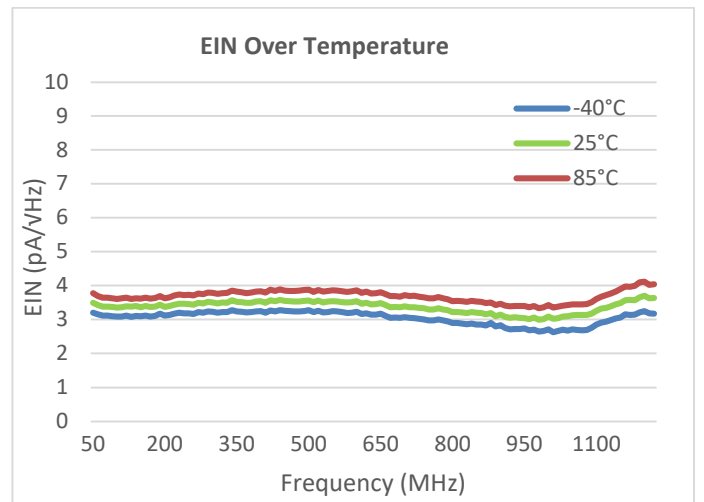
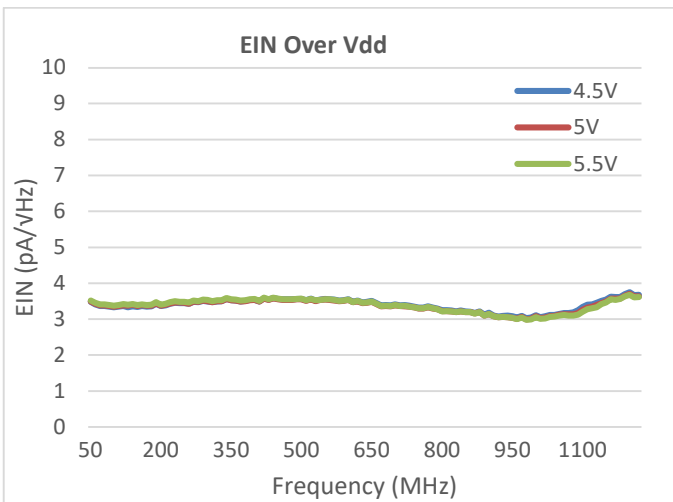
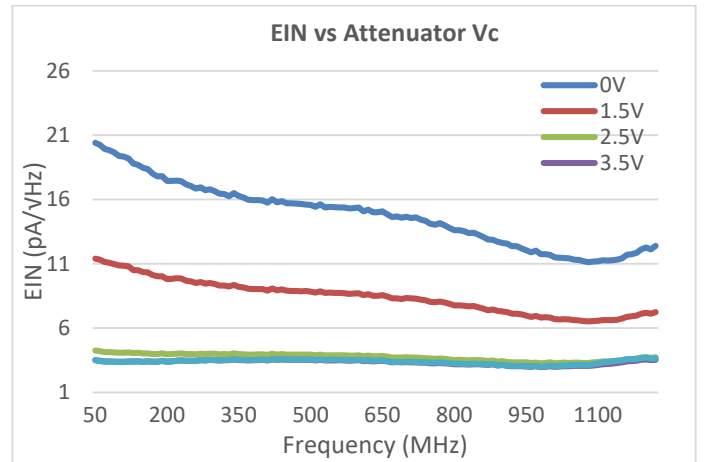
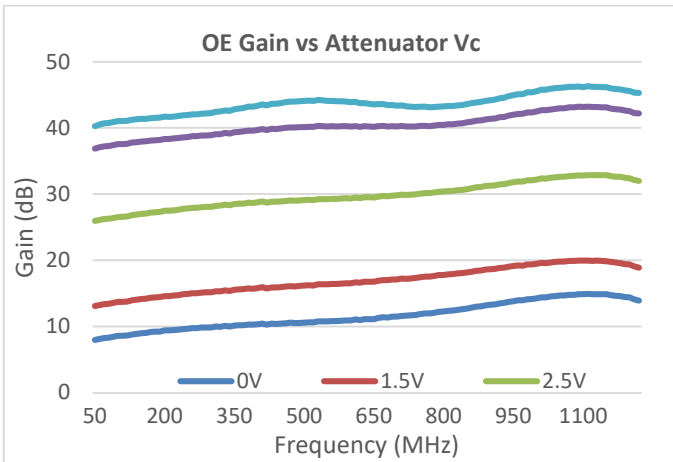
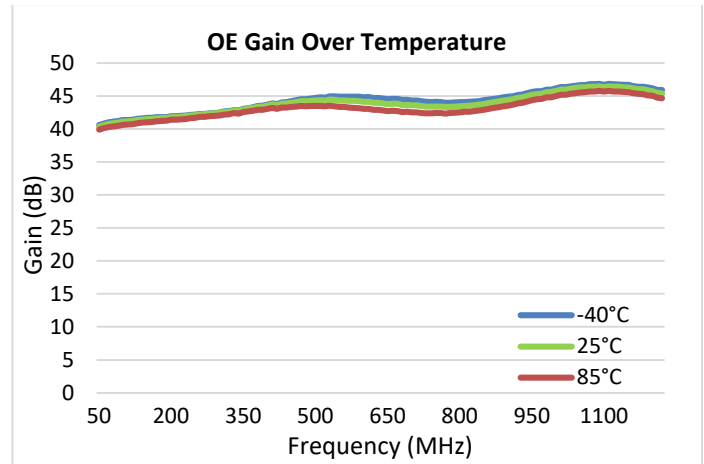
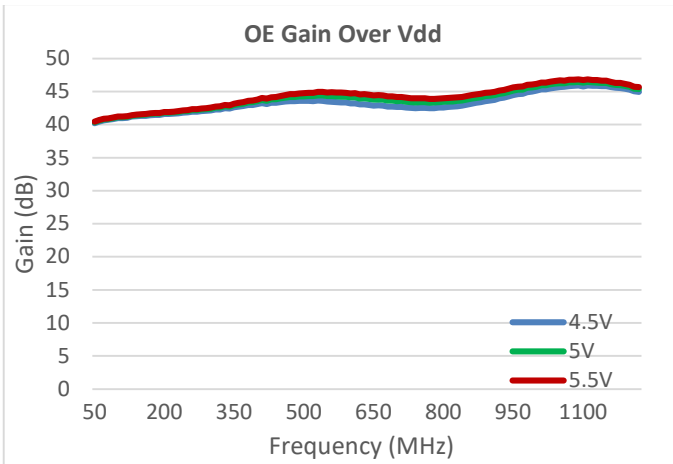

Test conditions unless otherwise stated: Temperature = +25 °C, V_{DD} = +5 V

Typical Performance – Optical Receiver Application EVB – QPB7432PCK (cont'd)

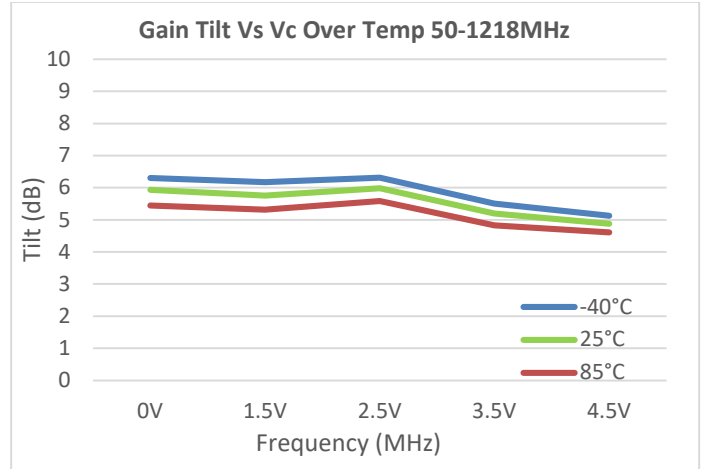
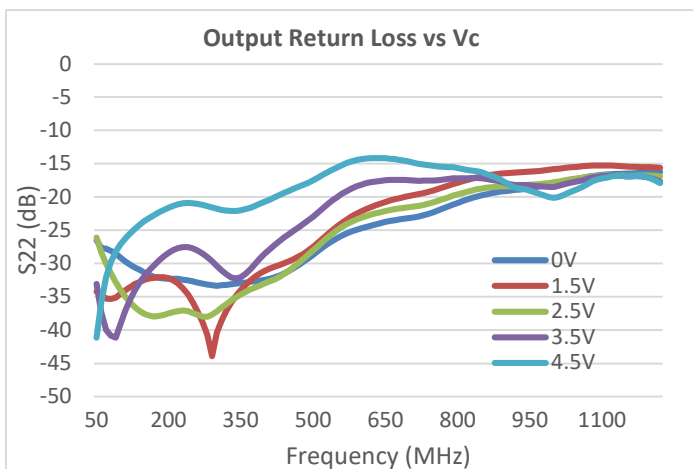
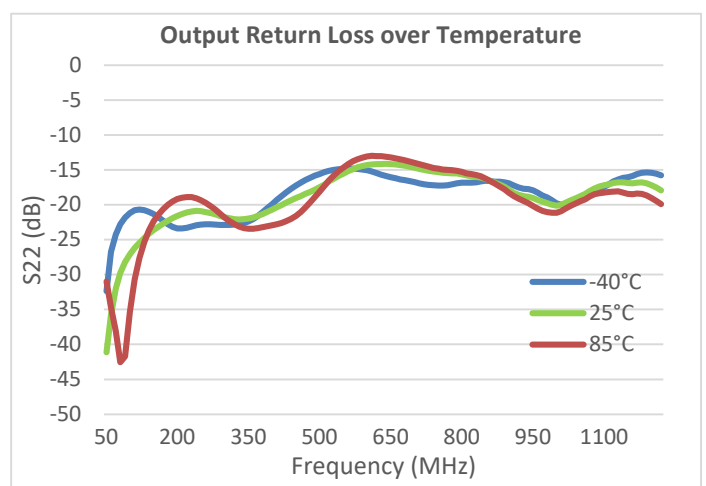
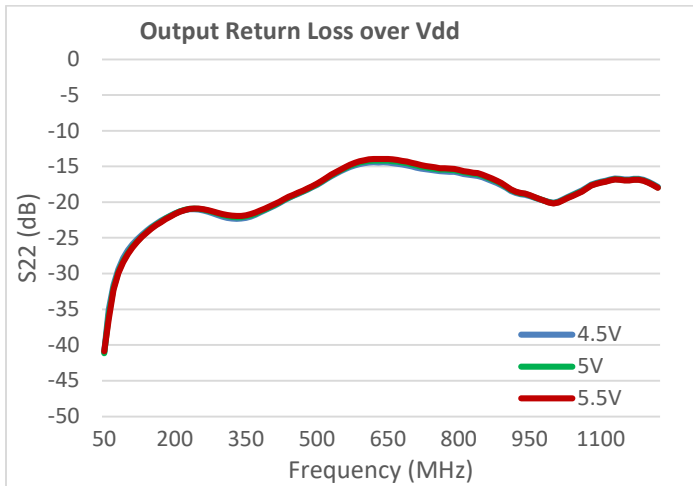
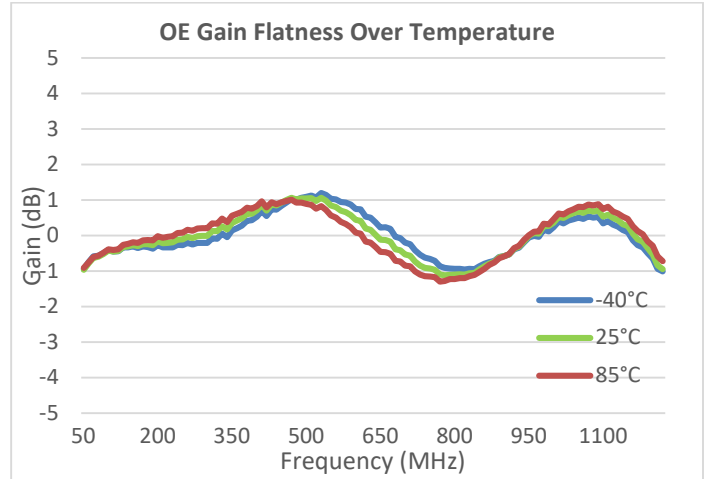
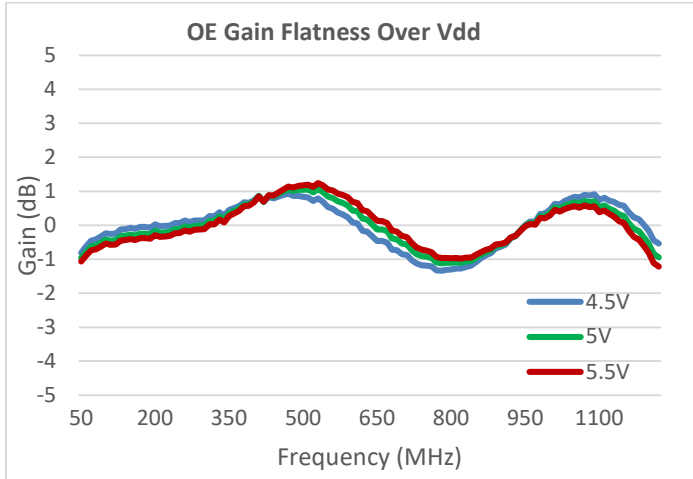

Test conditions unless otherwise stated: Temperature=+25 °C, V_{DD}=+5 V

Typical Performance: Optical Receiver Application EVB – QPB7432PCK (cont'd)

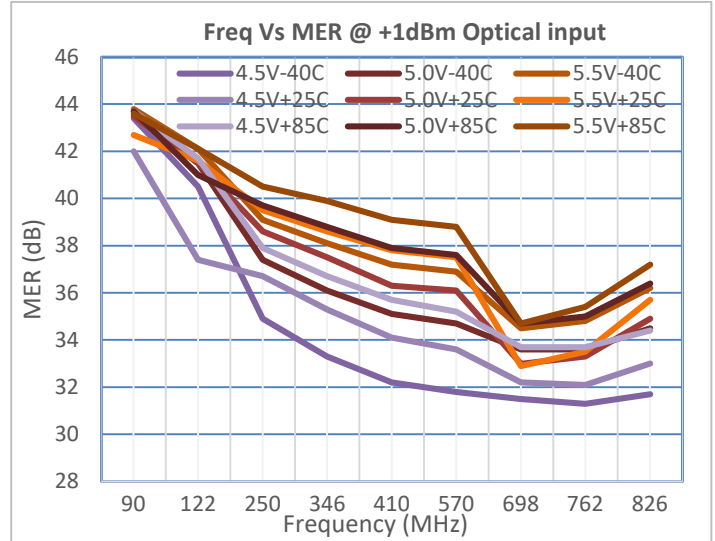
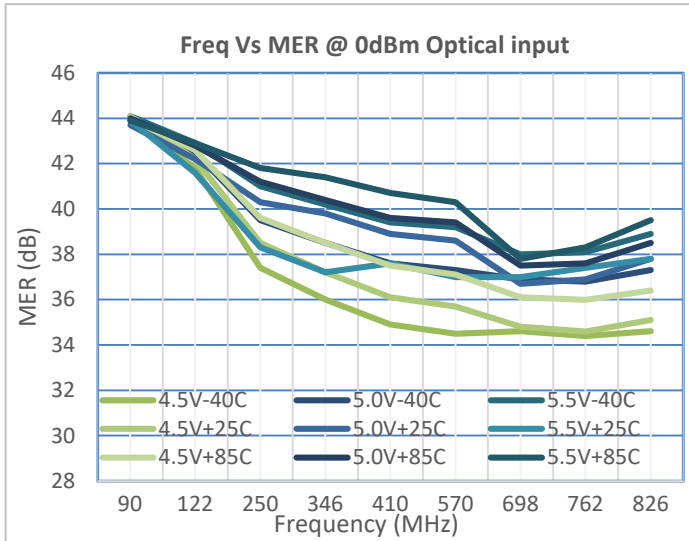
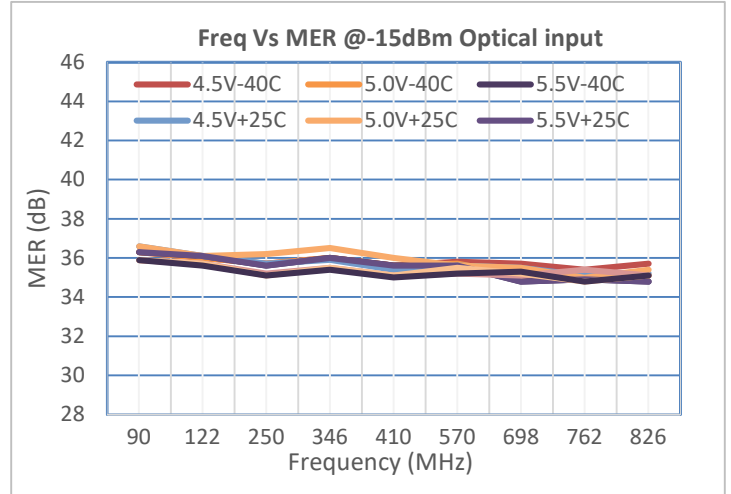
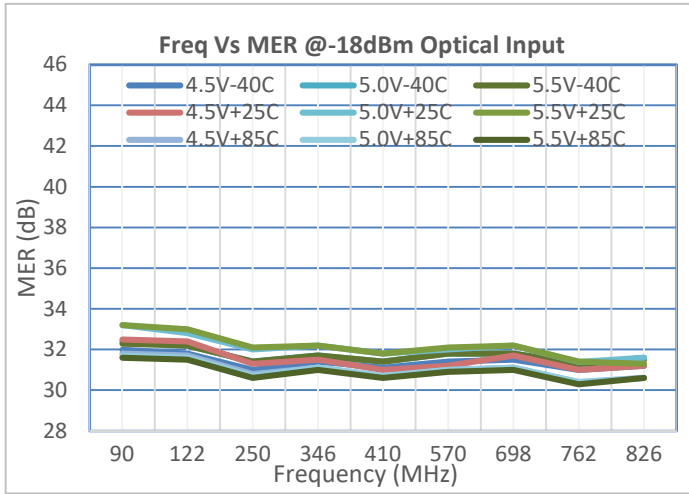

Test conditions unless otherwise stated: Temperature=+25 °C, V_{DD}=+5 V

Electrical Specifications: 75 Ω EVB – QPB7432PCK-2

Parameter	Condition ⁽¹⁾	Min	Typ	Max	Unit
Supply Current (I_{DD})	Steady state operation		110		mA
Frequency Range		47		1218	MHz
Gain	At 550 MHz		30.5		dB
Gain Flatness	At 550 MHz		± 0.5		dB
Tilt	At 550 MHz		± 4		dB
Reverse Isolation	At 50 – 1218 MHz		35		dB
Noise Figure	At 550 MHz		0.6		dB
Output Return Loss	At 550 MHz		-10		dB
Input Return Loss	At 550 MHz		-12		dB
P1dB	At 550 MHz		+20		
OIP2	At 550 MHz		+48		
OIP3	At 550 MHz		+40		
Thermal Resistance	T_{REF} taken at +85 °C from backside of PCB under the QPB7432		21.8		°C/W

Notes:

1. Typical performance at these conditions: Temperature = +25 °C, V_{DD} = +5 V, 75 Ω evaluation board

Schematic: 75 Ω EVB – QPB7432PCK-2

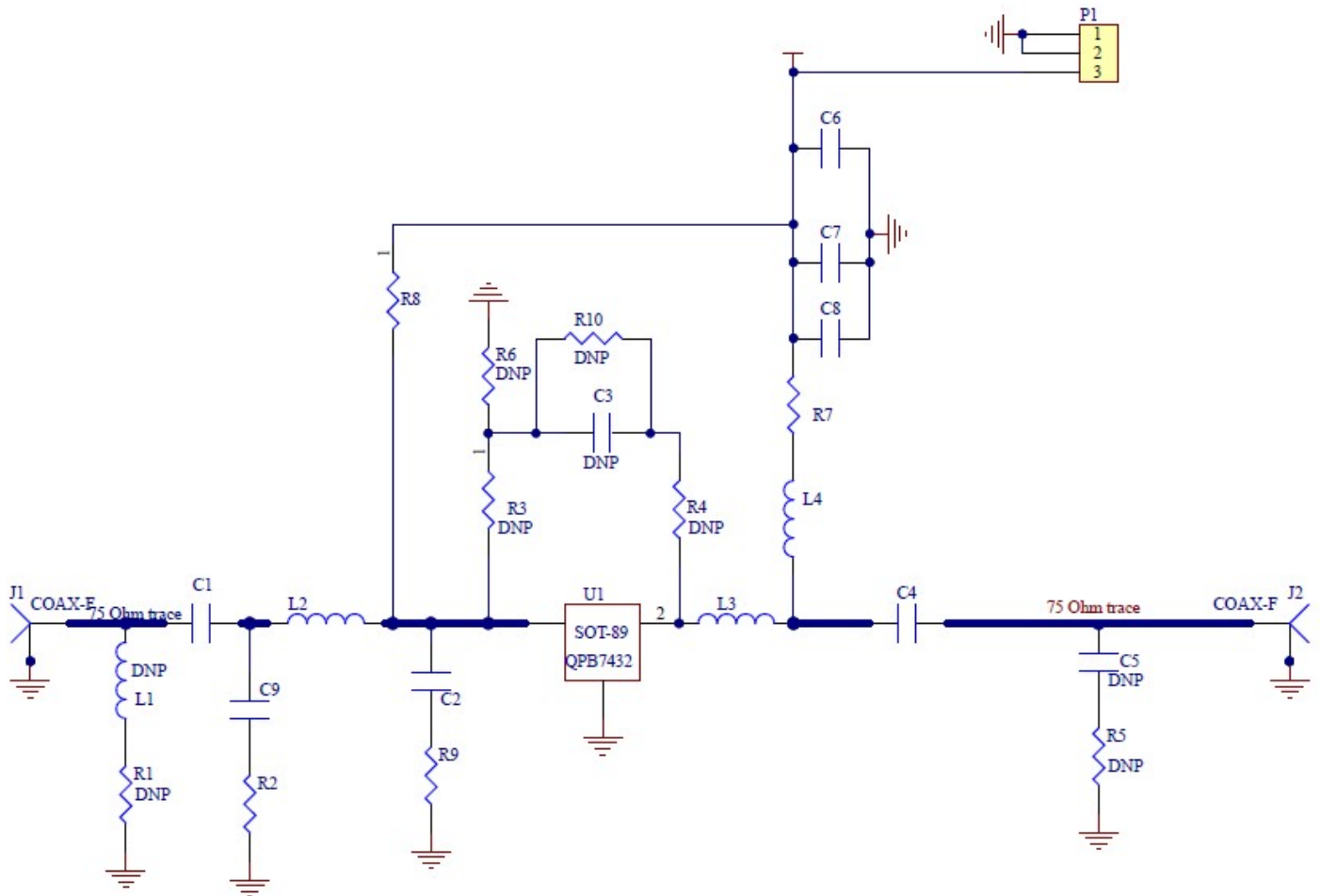

Bill of Materials: 75 Ω EVB – QPB7432PCK-2

Designator	Description	Manufacturer	Part Number
J1, J2	CONN, F FEM EDGE MOUNT, 75Ω	MILLIMETER WAVE TECH	MW-846-C-DD-75
R2	RES, 0 OHM, 0402	KAMAYA INC	RMC1/16SJPTH
R8	RES, 1.5M, 5%, 1/16W, 0402	KAMAYA INC	RMC1/16S-155JTH
R7	IND, 33nH, 5%, W/W, 0603	COILCRAFT INC	0603CS-33NXJBC
C1	CAP, 1000pF, 10%, 50V, STD, 0402	TAIYO YUDEN PTE LTD	UMK105B7102KV-F
C4	CAP, 220pF, 10%, 50V, X7R, 0402	TAIYO YUDEN PTE LTD	UMK105BJ221KV-F
C6	CAP, 1.0uF, +/-20%, 50V, STD, 1206	MURATA ELECTRONICS	GRM31MR71H105MA88L
C7	CAP, 1000pF, 5%, 100V, X7R, 0603	AVX ASIA LTD	06031C102JAT2A
C8	CAP, 100pF, 5%, 50V, C0G, 0603	MURATA ELECTRONICS	GRM1885C1H101JA01D
C9	CAP, 1.5pF, +/-0.1pF, COG, 0402	MURATA ELECTRONICS	GRM1555C1H1R5BA01D
L2	IND, 5.6nH, +/-0.1nH, T/F, 0402	MURATA ELECTRONICS	LQP15MN5N6B02D
L3	IND, 7.5nH, 5%, M/L, 0402	MURATA ELECTRONICS	LQG15HN7N5J02D
L4	IND, 680nH, 5%, 590mA, W/W, 0805	COILCRAFT INC	0805LS-681XJLC
P1	CONN, HDR, ST, 3-PIN, 0.100"	SAMTEC INC.	TSW-103-07-G-S
U1	QPB7432	QORVO INC	QPB7432
PCB BARE BOARD	RF-RF PCB, QPB7432	TTM Technologies	
R1, R3, R4, R5, R6, R9, R10, C2, C3, C5, L1		DUMMY PARTS	

Layout Drawing: 75 Ω EVB – QPB7432PCK-2

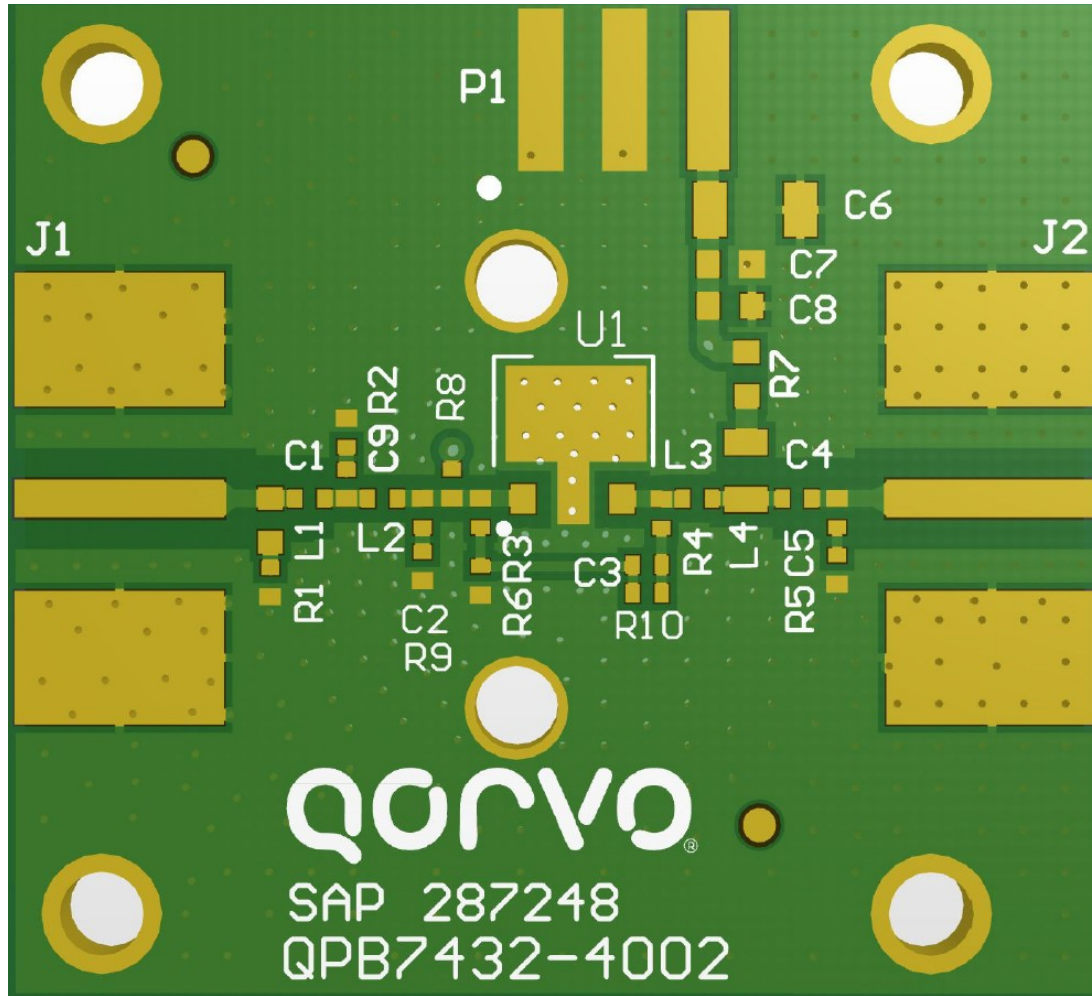

Typical Performance: 75 Ω EVB – QPB7432PCK-2

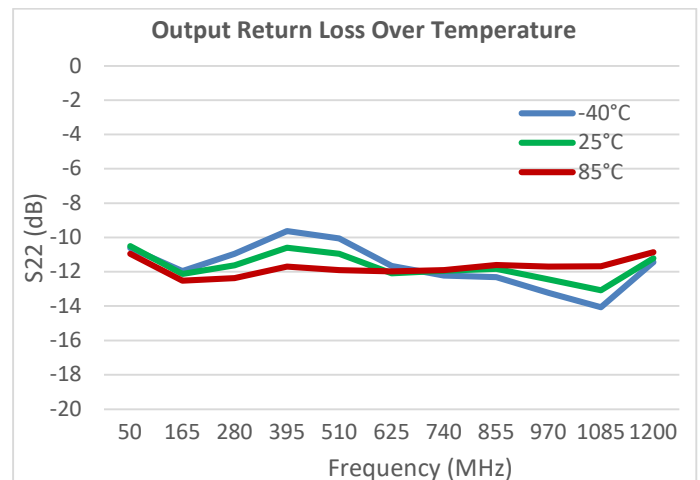
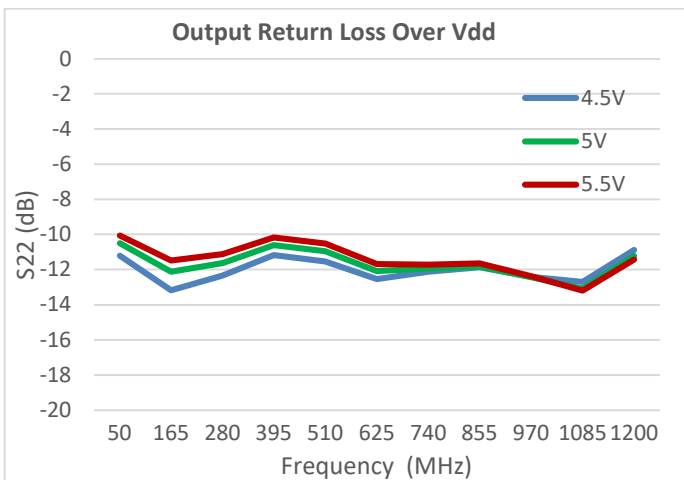
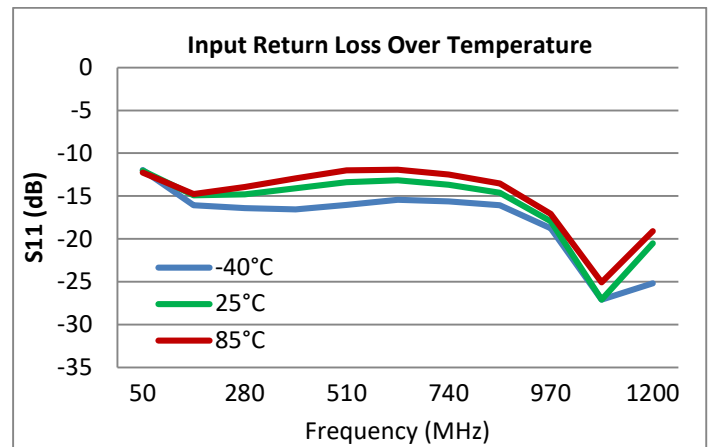
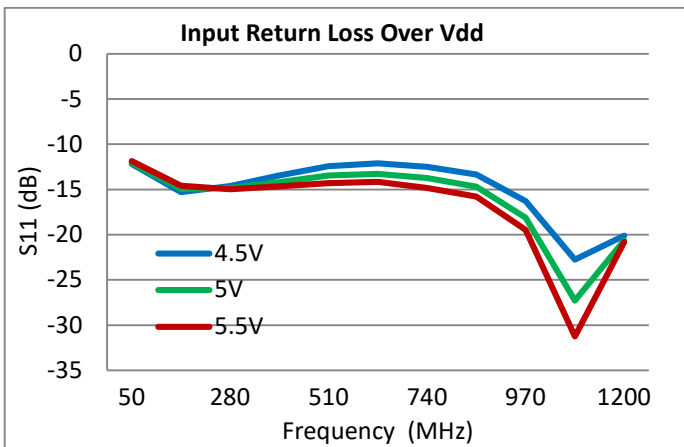
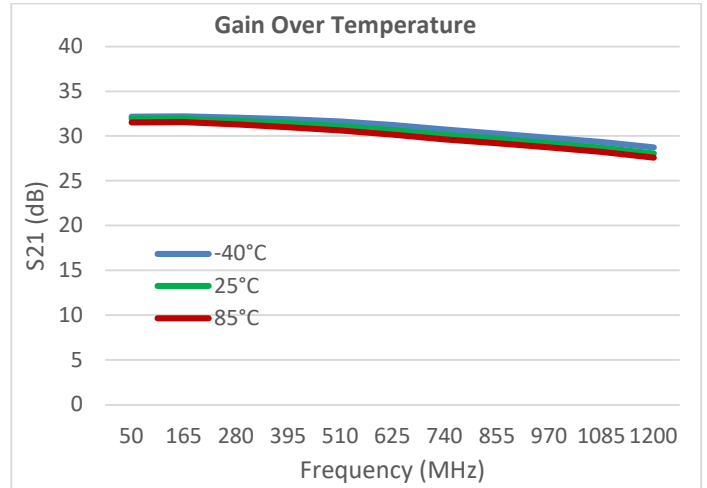
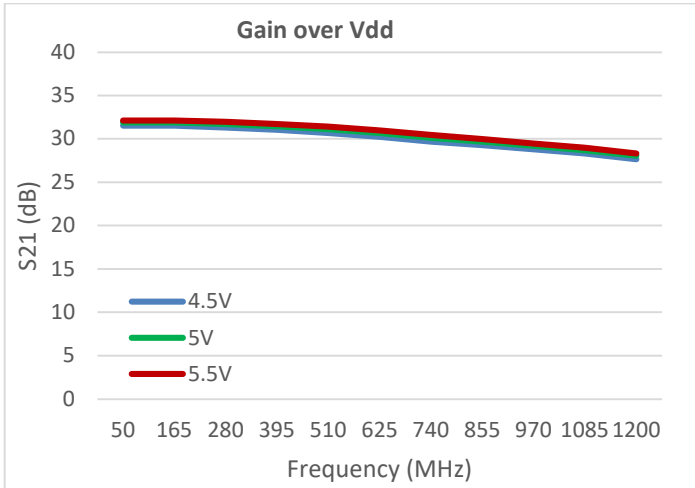

Test conditions unless otherwise stated: Temperature=+25 °C, V_{DD}=+5V

Typical Performance: 75 Ω EVB – QPB7432PCK-2 (cont'd)

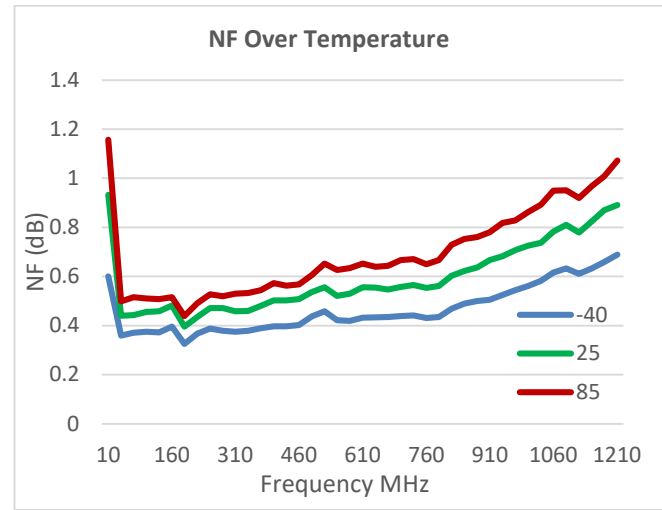
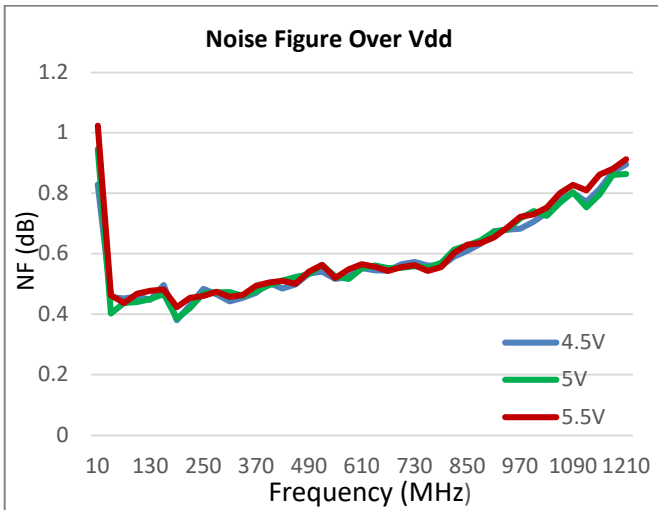
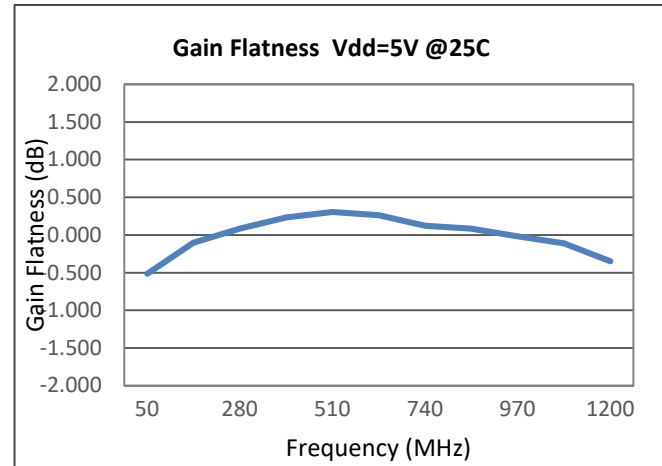
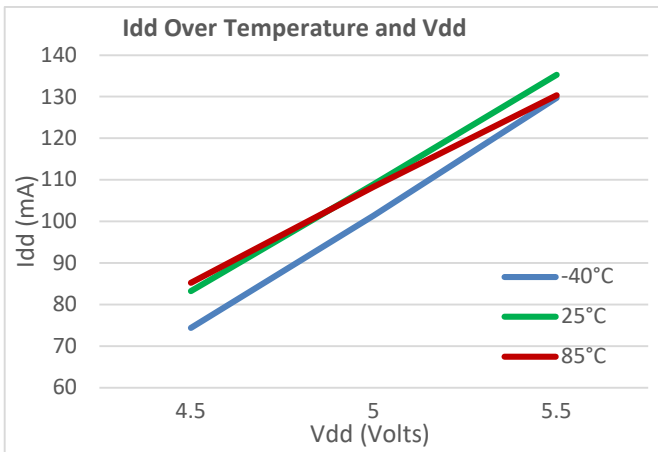
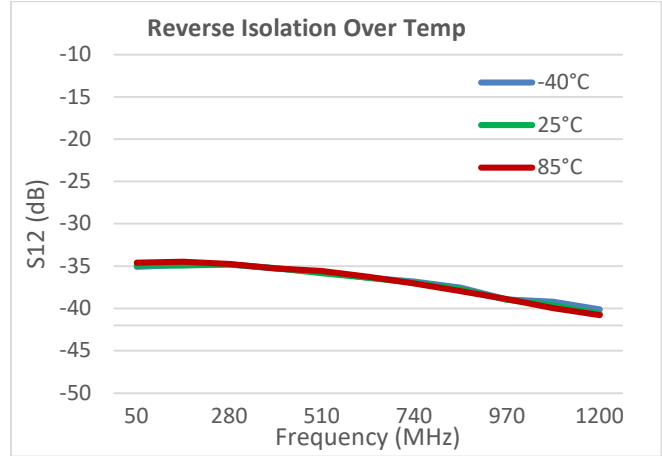
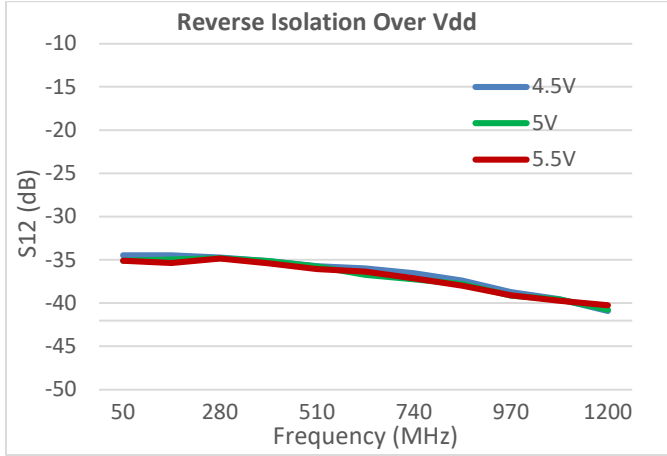

Test conditions unless otherwise stated: Temperature=+25°C, V_{DD}=+5 V

Typical Performance: 75 Ω EVB – QPB7432PCK-2 (cont'd)

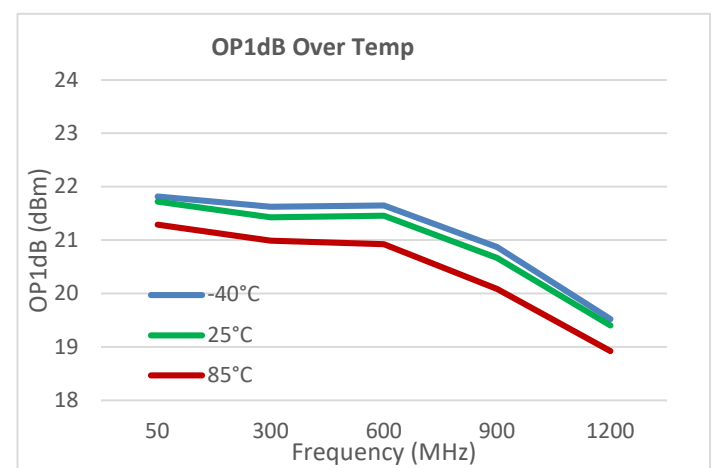
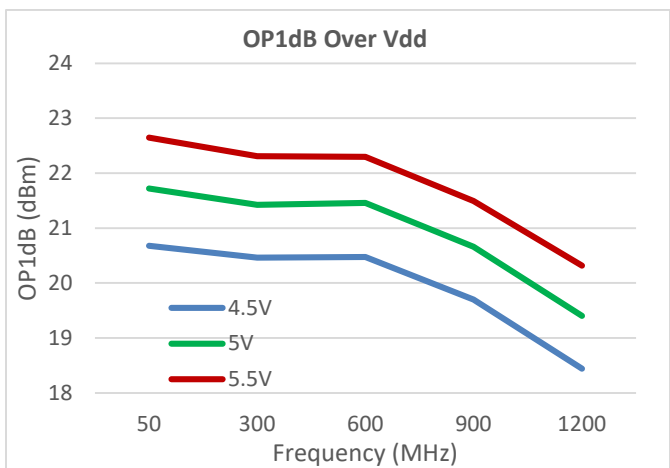
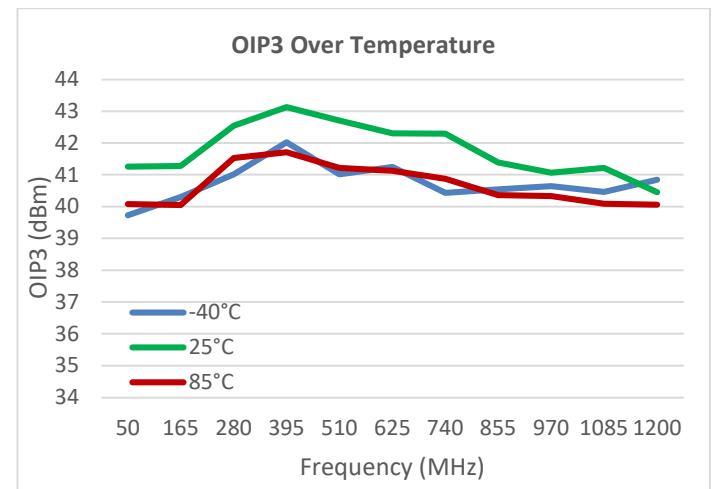
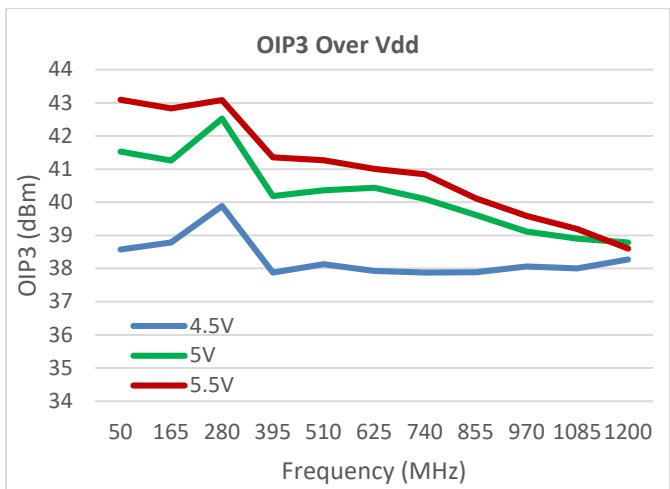
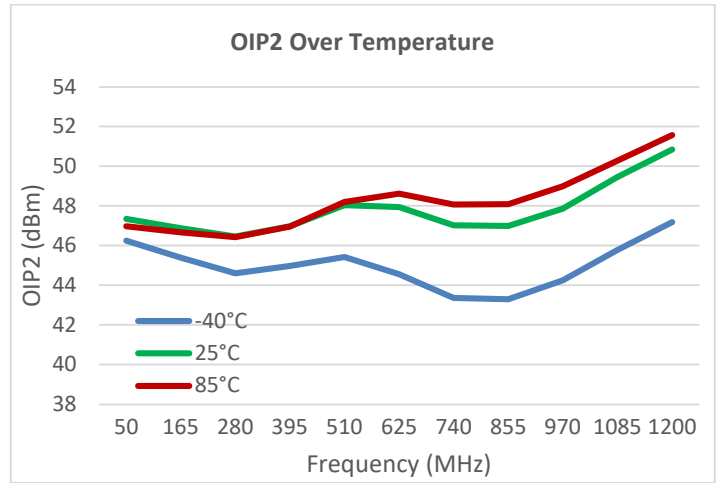
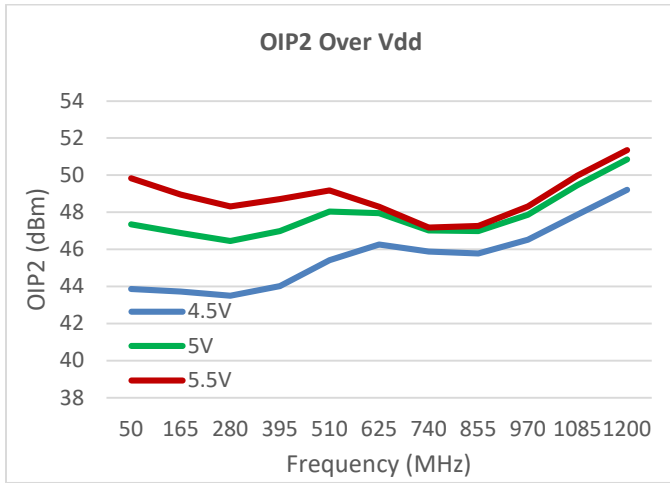

Test conditions unless otherwise stated: Temperature=+25°C, V_{DD}=+5 V

Application Specifications: Optical to Electrical EVB – QPB7432PCK-3

Parameter	Condition ⁽¹⁾	Min	Typ	Max	Unit
Supply Current (I _{DD})	Steady state operation		85		mA
Frequency Range		47		1218	MHz
Optical Gain	At 550MHz. O/E gain is defined by 20*log (Zt/75)		31		dB
Gain Flatness			±1.5		dB
Tilt	Linear tilt from 45 – 1218 MHz; higher tilt can be achieved by changing components		6		dB
Equivalent Input Noise			3.5		pA / √Hz
RF Output Level at 547.25 MHz	RF Output Level at 547.25 MHz		+8		dBmV/Ch
	At 45 MHz		-12		dB
Output Return Loss	At 600 MHz		-10		dB
	At 1218 MHz		-15		dB
MER	90MHz to 850MHz, 0dB tilt, 96 channels, 8MHz spacing. ITU-T Annex A 256 QAM 6.952 MSymbols. OMI=3.5%	At -18dBm	31		dB
		At -15dBm	36		dB
		At +1dBm	36		dB
BER				2.0E-5	

Notes:

- Typical performance at these conditions:
Temperature =+25 °C, V_{DD}=+5 V, Optical Input to Electrical RF Out EVB

Schematic: Optical to Electrical EVB – QPB7432PCK-3

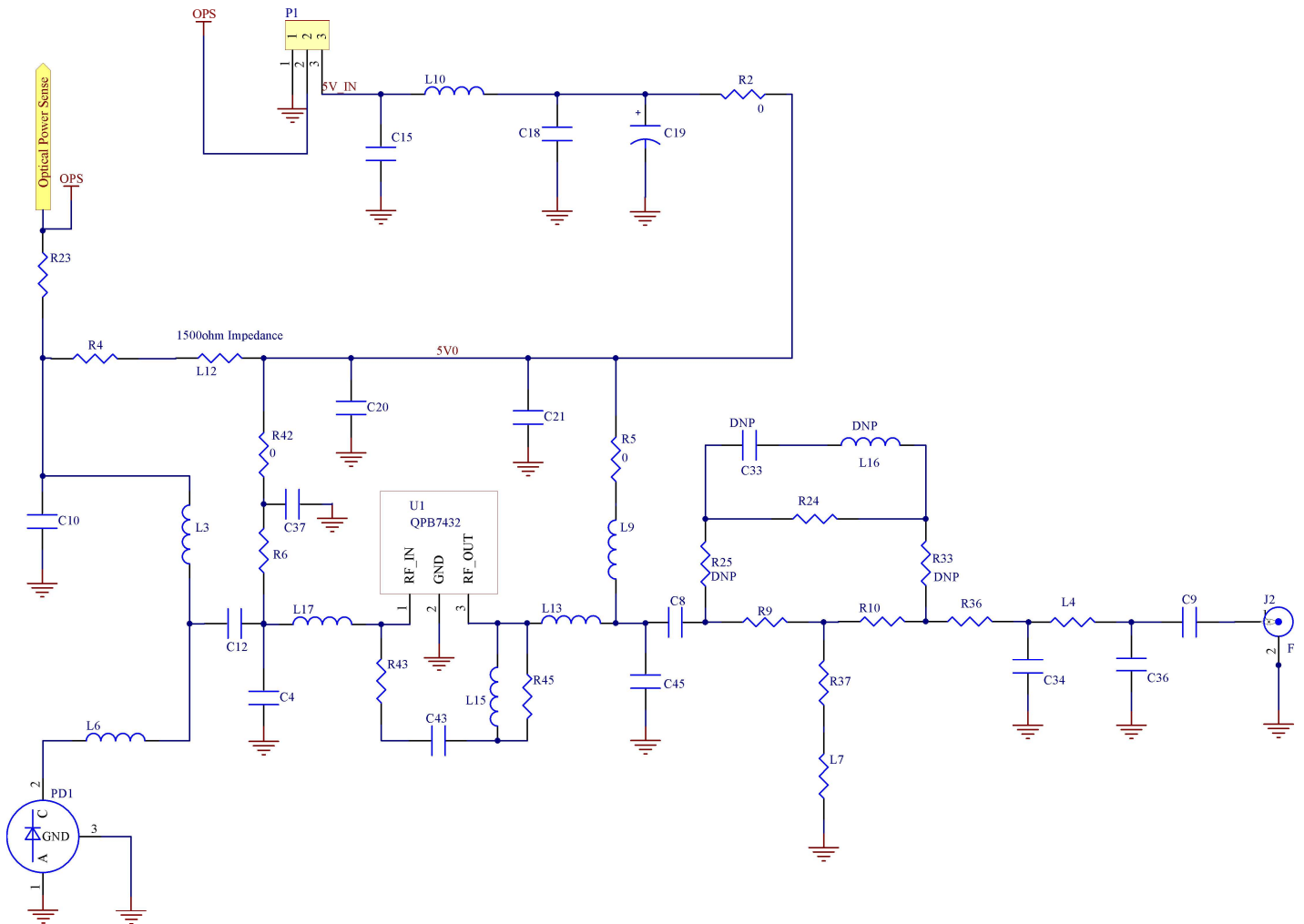

Bill of Materials: Optical to Electrical EVB – QPB7432PCK-3

Designator	Description	Manufacturer	Part Number
U1	FTTH - Low EINC Optical Front End	Qorvo	QPB7432
C21, L7	CAP, 100pF, 5%, 50V, COG, 0402	Murata Electronics	GRM1555C1H101JA01D
C15, C18	CAP, 0.1uF, 10%, 16V, X7R, 0603	Murata Electronics	GRM188R71C104KA01D
C19	CAP, 10uF, 10%, 16V, TANT-B	AVX Asia Limited	TAJB106K016RNJ
C34	CAP, 2.4pF, +/-0.25pF, 25V, HI-Q, 01005	Taiyo Yuden	TVS042CG2R4CC-W
C8, C9, C10, C12, C20, C37, C43, L15	CAP, 1000pF, 10%, 50V, X7R, 0402	Taiyo Yuden	UMK105B7102KV-F
C36	CAP, 1pF, +/-0.1pF, 100V, HI-Q, 0402	Kamaya, Inc	RF15N1R0B101CT
R37	RES, 178 Ohms, 1%, 0.05W, 0402	Vishay Americas Inc	M55342K11B178DSW
R9	RES, 56 OHM, 5%, 1/10W, 0402	Panasonic Industrial Devices Sales	ERJ-2GEJ560X
R10, R42	RES, 0 OHM, 5%, 1/10W, 0402	Kamaya, Inc	RMC1/16SJPTH
R6	RES, 1.5M, 5%, 1/16W, 0402	Kamaya, Inc	RMC1/16S-155JTH
R43, R45	RES, 3.92K, 1%, 1/16W, 0402	Panasonic Industrial Devices	ERJ-2RKF3921X
R23	RES, 10K, 1%, 1/16W, 0402	Panasonic Industrial Devices	ERJ-2RKF1002X
R4	RES, 200 OHM, 5%, 1/16W, 0402	Panasonic Industrial Devices	ERJ-2GEJ201
R2, R5	Res, 0R /0603/Chip		
PD1	DIO, PHOTO, 1000-1650nm, 6GHz, SC/APC	SWT Beijing	PDS133-CSA-C0104
R36	IND, 10nH, 3%, 500mA, W/W, 0402	Murata Electronics	LQW15AN10NH00D
L4	IND, 12nH, 3%, W/W, 0402	Murata Electronics	LQW15AN12NH00D
L9	IND, 1uH, 5%, W/W, 0805	Coil craft, Inc.	0805LS-102XJLC
L3	IND, 880nH, 5%, W/W, 0805	Gowanda Electronics	CC0805-880J-2
L10	IND, 470nH, 5%, W/W, 0805	Coil craft, Inc.	0805LS-471XJRC
L13	IND, 4.7nH, +/-0.1nH, W/W, 0402	Murata Electronics	LQW15AN4N7B00D
L17	IND, 6.8nH, 2%, W/W, 0402	Murata Electronics	LQW15AN6N8G00D
L6	IND, 2.2nH, +/-0.2nH, W/W, 0402	Murata Electronics	LQW15AN2N2C10D
L12	FER, BEAD, 1500 OHM, 500mA, 0603	Murata Electronics	BLM18HE152SN1D
P1	CONN, HDR, ST, 3-PIN, 0.100"	SAMTEC INC.	TSW-103-07-G-S
J2	CONN, F FEM EDGE MOUNT, 750hms	Millimeter Wave Tech., LLC	MW-846-C-DD-75
C4, C45, C33, L16, R24, R25, R33	NOT POPULATED ITEM-1		DUMMY PART

Layout Drawing: Optical to Electrical EVB – QPB7432PCK-3

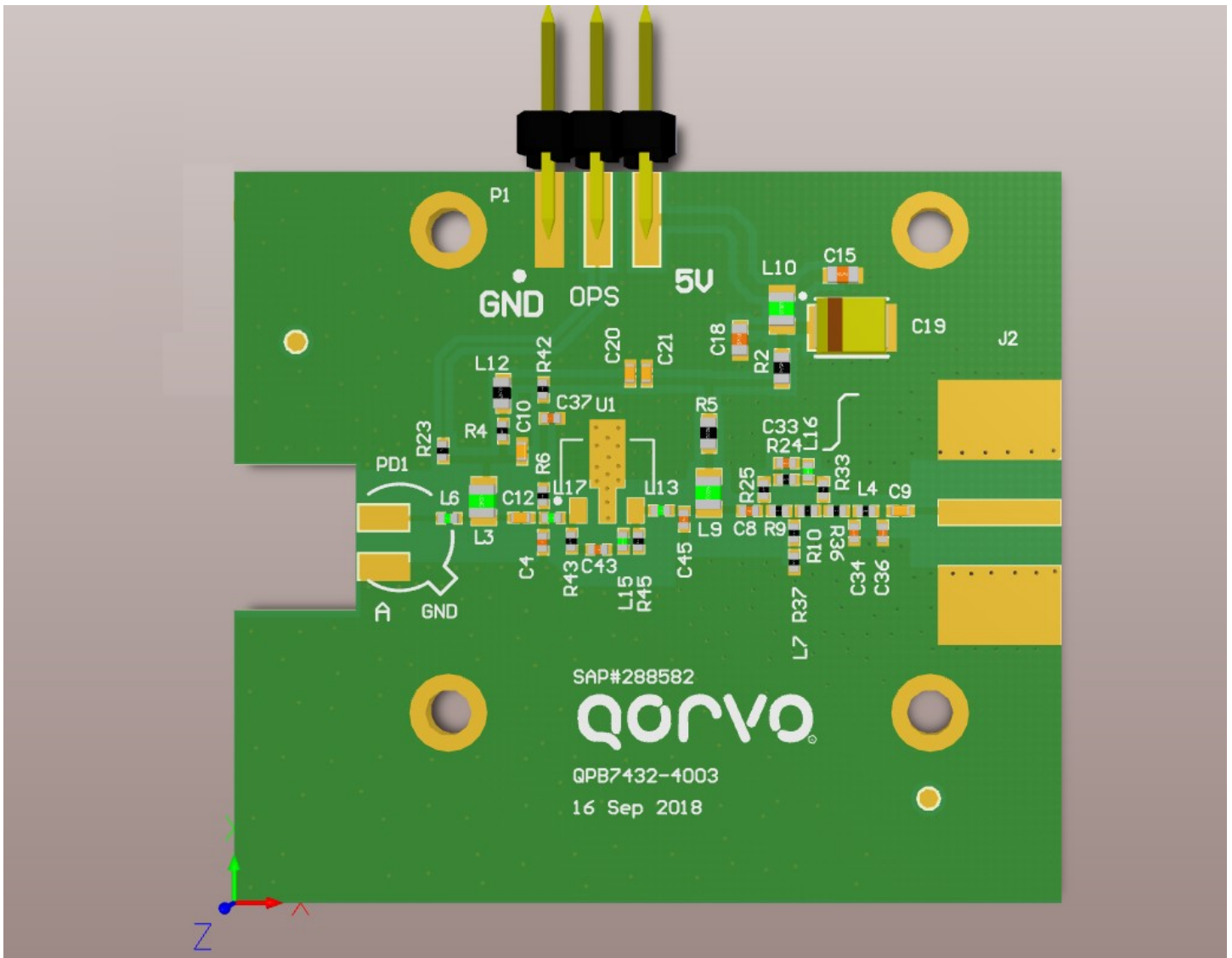

Typical Performance: Optical to Electrical EVB – QPB7432PCK-3

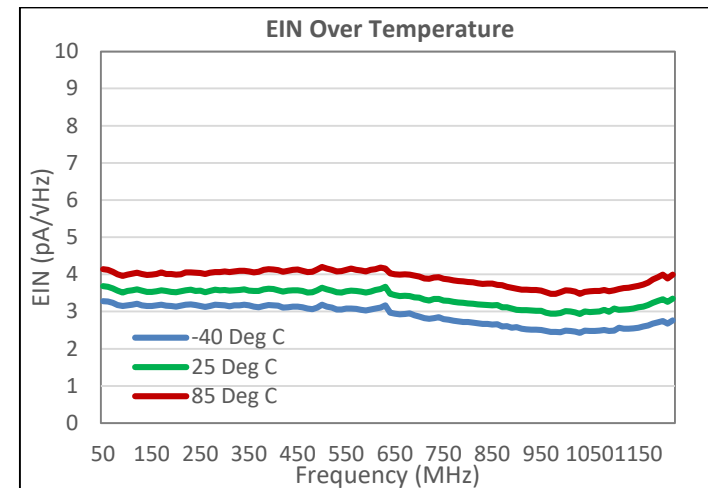
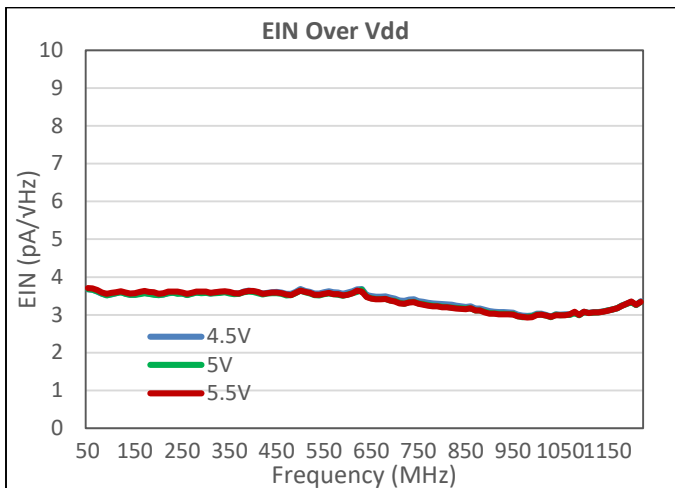
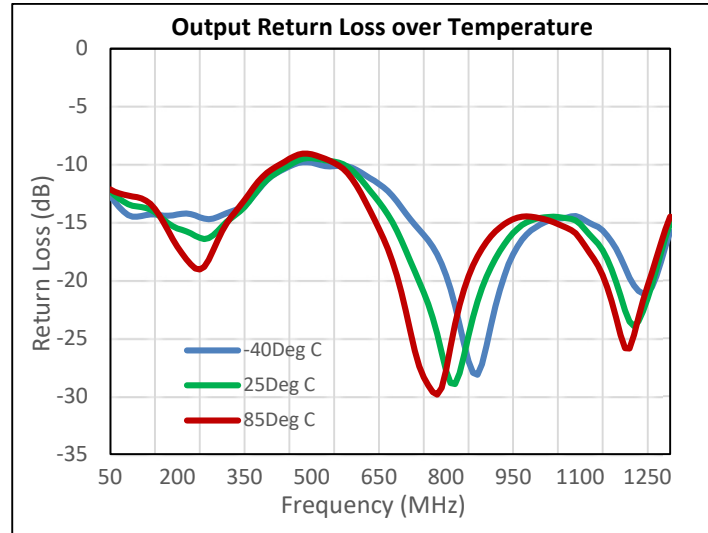
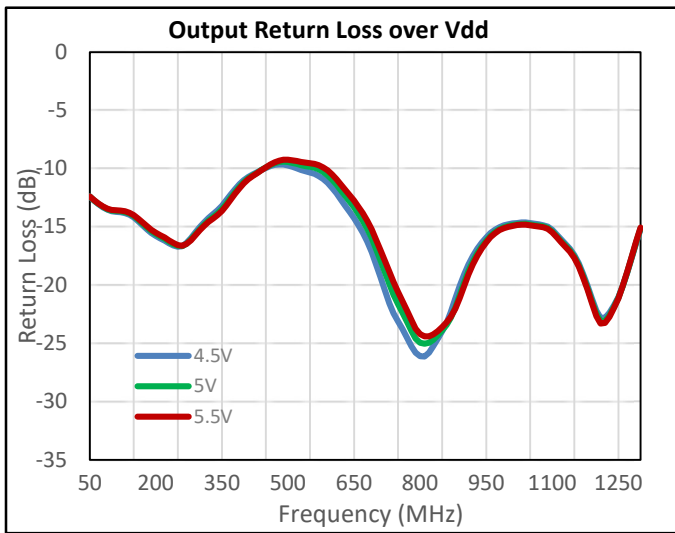
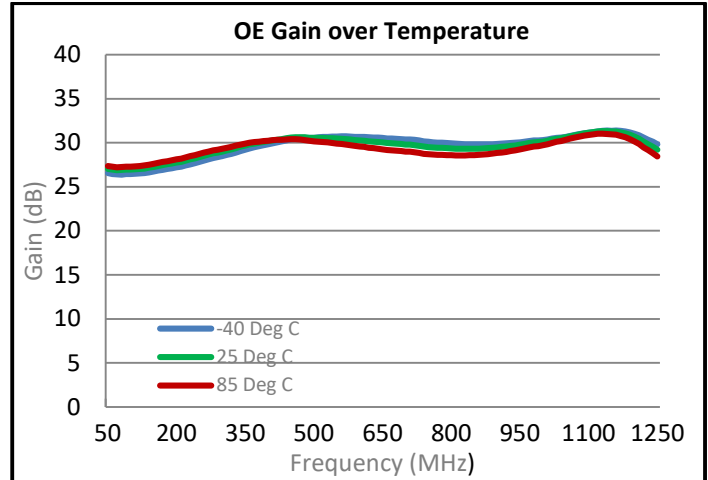
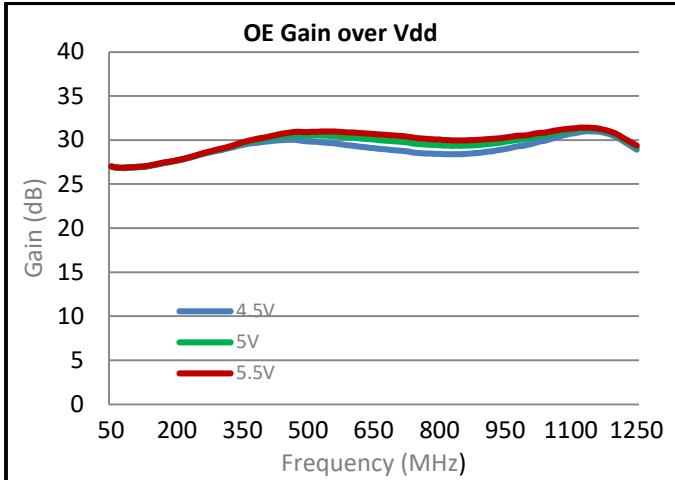

Typical Performance: Optical to Electrical EVB – QPB7432PCK-3 (cont'd)

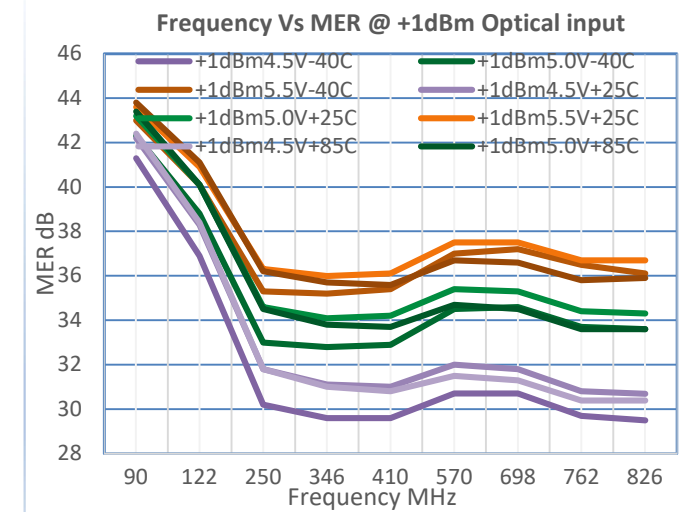
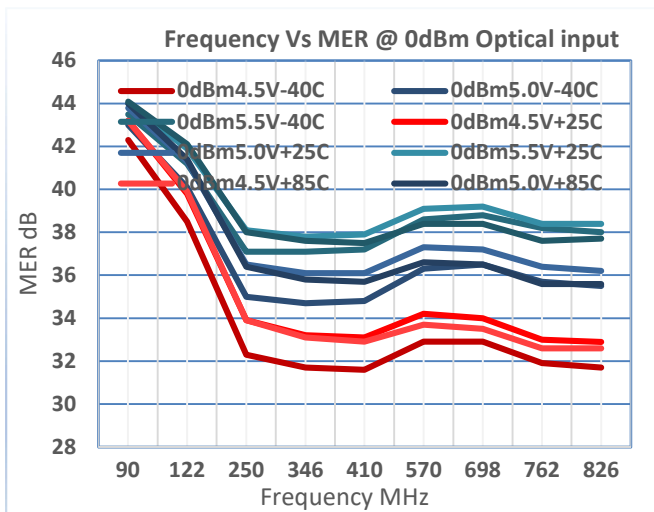
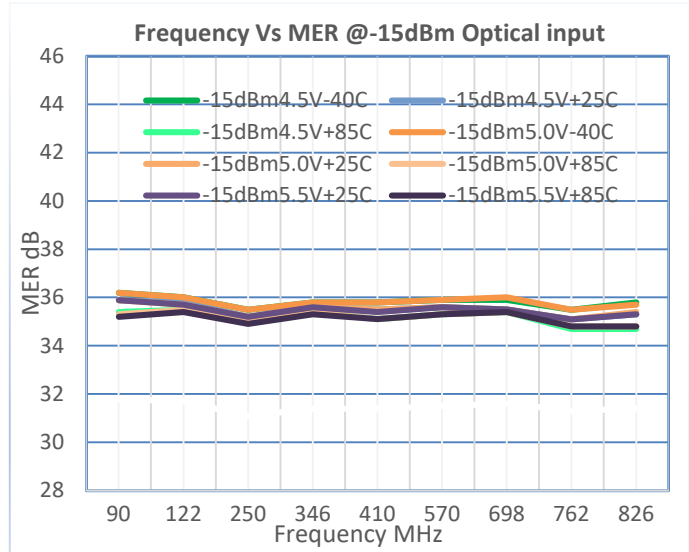
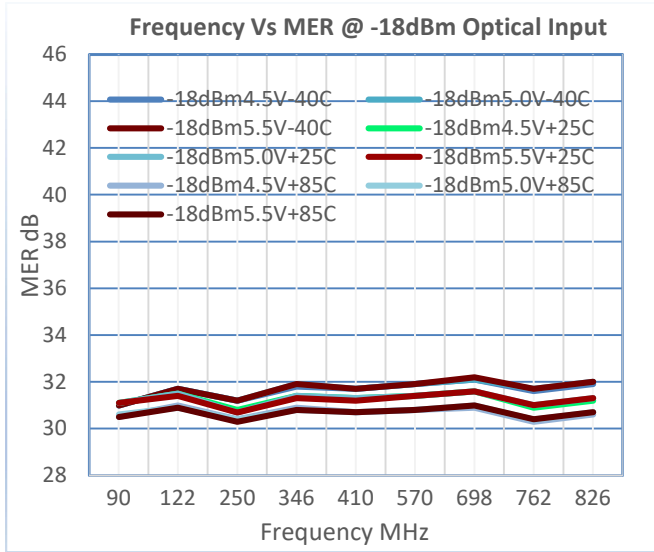

Pin Configuration and Description

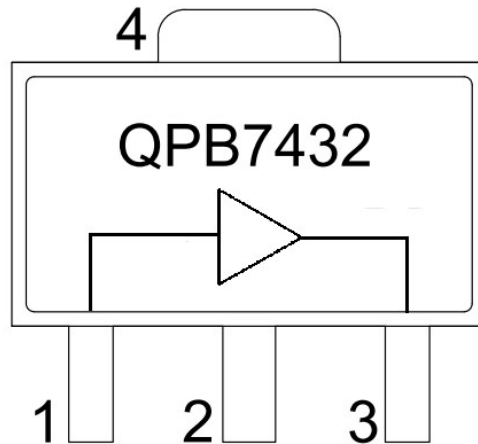

Pin Number	Label	Description
1	RF IN	RF Input, DC blocking capacitor required.
2	GND	Internally not connected.
3	RF OUT/VDD	RF Output – VDD bias choke required.
4 Backside Paddle	GND	Ground. Use recommended via pattern to minimize inductance and thermal resistance. See PCB Mounting Pattern for suggested footprint.

Package Dimensions

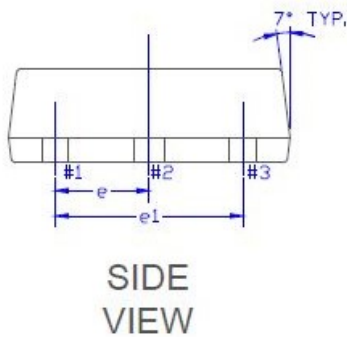
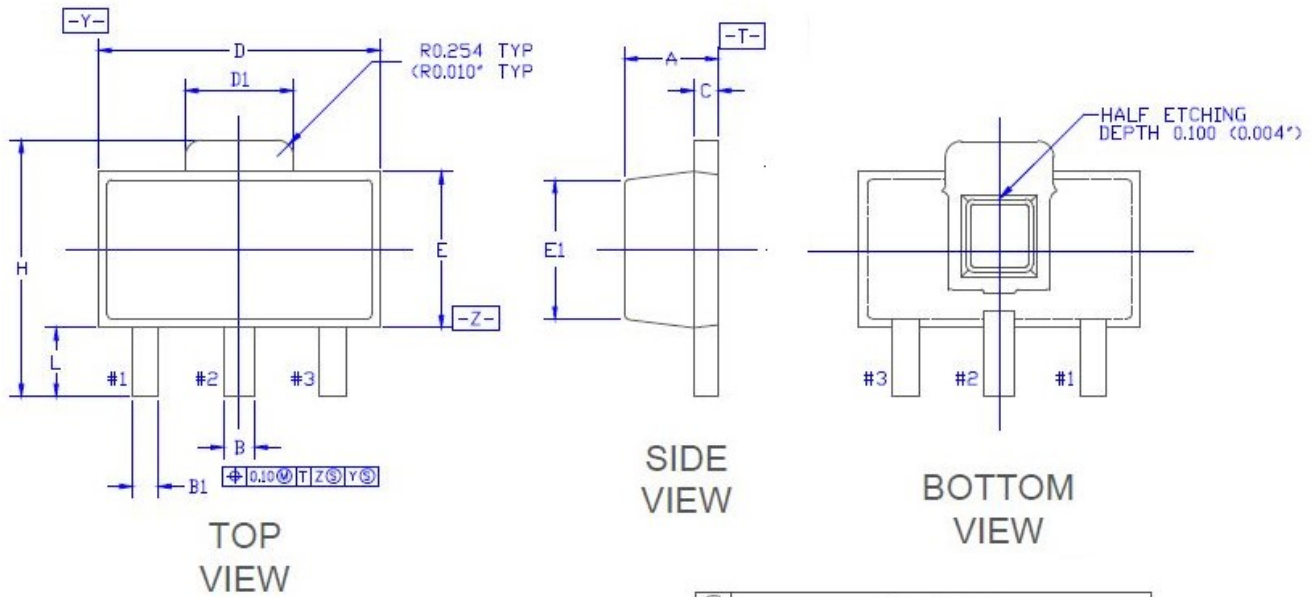

SYMBOL	Common					
	DIMENSIONS MILLIMETER			DIMENSIONS INCH		
	MIN.	NOM.	MAX.	MIN.	NOM.	MAX.
A	1.40	1.50	1.60	0.055	0.059	0.063
B	0.44	0.50	0.56	0.017	0.020	0.022
B1	0.36	0.42	0.48	0.014	0.017	0.019
C	0.35	0.40	0.44	0.014	0.016	0.017
D	4.40	4.50	4.60	0.173	0.177	0.181
D1	1.62	1.73	1.83	0.064	0.068	0.072
E	2.30	2.50	2.60	0.091	0.098	0.102
E1	2.13	2.20	2.29	0.084	0.087	0.090
e	1.50 BSC.			0.059 BSC.		
e1	3.00 BSC.			0.118 BSC.		
H	3.95	4.10	4.25	0.156	0.161	0.167
L	0.90	1.10	1.20	0.035	0.043	0.047

Notes:
Dimensions in millimeters

Package Marking

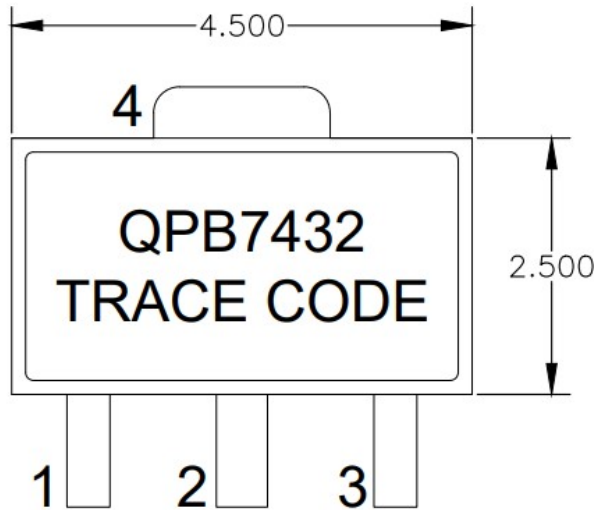

TRACE CODE TO BE ASSIGNED BY SUBCON.

Recommended Mounting Pattern

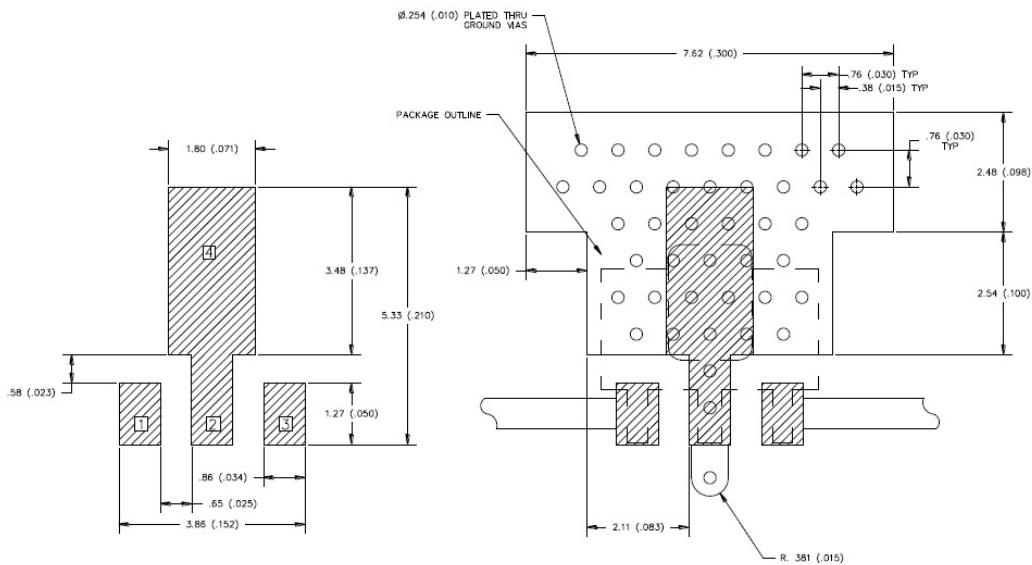

Notes:

1. Ground/thermal vias are critical for the proper performance of this device. Vias should use a .35 mm (#80/.0135") diameter drill and have a final, plated thru diameter of 0.25 mm (0.010").
2. Add as much copper as possible to inner and outer layers near the part to ensure optimal thermal performance.
3. RF trace width depends upon the PC board material and construction.
4. All dimensions are in millimeters (inches). Angles are in degrees.

Handling Precautions

Parameter	Rating	Standard
ESD – Human Body Model (HBM)	1C	ESDA / JEDEC JS-001-2012
ESD – Charged Device Model (CDM)	C3	JEDEC JESD22-C101F
MSL – Moisture Sensitivity Level	MSL3	IPC/JEDEC J-STD-020



Caution!
ESD-Sensitive Device

Solderability

Compatible with both lead-free (260°C max. reflow temperature) and tin/lead (245°C max. reflow temperature) soldering processes. Solder profiles available upon request.

Contact plating: Matte Sn

Import / Export Compliance

ECCN	5A991B
Schedule B	8542330001

RoHS Compliance

This product is compliant with the 2011/65/EU RoHS directive (Restrictions on the Use of Certain Hazardous Substances in Electrical and Electronic Equipment), as amended by Directive 2015/863/EU.

This product also has the following attributes:

- Lead Free
- Halogen Free (Chlorine, Bromine)
- Antimony Free
- TBBP-A (C₁₅H₁₂Br₄O₂) Free
- PFOS Free
- SVHC Free



Contact Information

For the latest specifications, additional product information, worldwide sales and distribution locations:

Web: www.qorvo.com

Tel: 1-844-890-8163

Email: customer.support@qorvo.com



Important Notice

The information contained herein is believed to be reliable; however, Qorvo makes no warranties regarding the information contained herein and assumes no responsibility or liability whatsoever for the use of the information contained herein. All information contained herein is subject to change without notice. Customers should obtain and verify the latest relevant information before placing orders for Qorvo products. The information contained herein or any use of such information does not grant, explicitly or implicitly, to any party any patent rights, licenses, or any other intellectual property rights, whether with regard to such information itself or anything described by such information. **THIS INFORMATION DOES NOT CONSTITUTE A WARRANTY WITH RESPECT TO THE PRODUCTS DESCRIBED HEREIN, AND QORVO HEREBY DISCLAIMS ANY AND ALL WARRANTIES WITH RESPECT TO SUCH PRODUCTS WHETHER EXPRESS OR IMPLIED BY LAW, COURSE OF DEALING, COURSE OF PERFORMANCE, USAGE OF TRADE OR OTHERWISE, INCLUDING THE IMPLIED WARRANTIES OF MERCHANTABILITY AND FITNESS FOR A PARTICULAR PURPOSE.**

Without limiting the generality of the foregoing, Qorvo products are not warranted or authorized for use as critical components in medical, life-saving, or life-sustaining applications, or other applications where a failure would reasonably be expected to cause severe personal injury or death.

Copyright 2018 © Qorvo, Inc. | Qorvo is a registered trademark of Qorvo, Inc.

X-ON Electronics

Largest Supplier of Electrical and Electronic Components

Click to view similar products for [Fibre Optic Transmitters, Receivers, Transceivers](#) category:

Click to view products by [Qorvo](#) manufacturer:

Other Similar products are found below :

[STV.2413-574-00262](#) [TRPRG1VA1C000E2G](#) [TOTX1350\(V,F\)](#) [FTLX3813M349](#) [SCN-1428SC](#) [LTK-ST11MB](#) [HFD8003-002/XBA](#)
[HFD3020-500-ABA](#) [FTLF1429P3BCVA](#) [S6846](#) [SCN-2638SC](#) [FTL410QE4N](#) [FTLC9555FEPM](#) [TQS-QG4H9-J83](#) [SCN-1570SC](#) [SCN-](#)
[1601SC](#) [SCN-1338SC](#) [SFPPT-SR3-01](#) [HFD8003-500-XBA](#) [SCN-1383SC](#) [2333569-1](#) [LNK-ST11HB-R6](#) [FTL4C1QL3L](#) [FTL4C1QE3L](#)
[FTL4C1QL3C](#) [SPTSHP3PMCDF](#) [SPTSBP4LLCDF](#) [SPTMBP1PMCDF](#) [SPTSHP2PMCDF](#) [SF-NLNAMB0001](#) [SPTSHP2SLCDF](#)
[SPTSQP4LLCDF](#) [1019682](#) [1019683](#) [1019705](#) [HFBR-1415Z](#) [AFBR-5803ATQZ](#) [AFBR-5803ATZ](#) [PLR135/T9](#) [TGW-Q14BB-FCQ](#) [AFBR-](#)
[5803AZ](#) [TQS-Q1LH8-XCA03](#) [TQS-Q1LH8-XCA05](#) [TQS-Q1LH8-XCA10](#) [TQS-Q1LH9-2CA](#) [HFBR-1414Z](#) [HFBR-1527Z](#) [HFBR-1528Z](#)
[HFBR-2406Z](#) [HFBR-2505AZ](#)