

### Product Overview

QPC4043 is a fully monolithic voltage-controlled attenuator (VCA) that provides over 25dB of gain control range over a frequency range of 5MHz to 3000MHz. The QPC4043 employs a closed loop design that provides a more controlled attenuation response over frequency and temperature conditions. This attenuator is matched to 75Ω over its control range and frequency with no external matching components required. The QPC4043 is available in a space saving 16-pin 3 x 3mm Laminate (LGA) package with minimal external components.

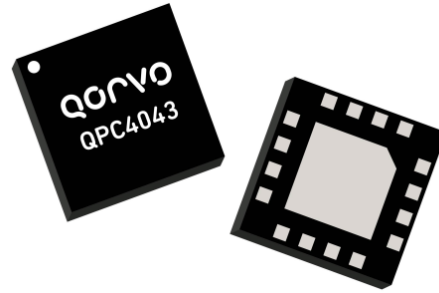

16 Pin 3 x 3mm Laminate (LGA) Package

### Functional Block Diagram

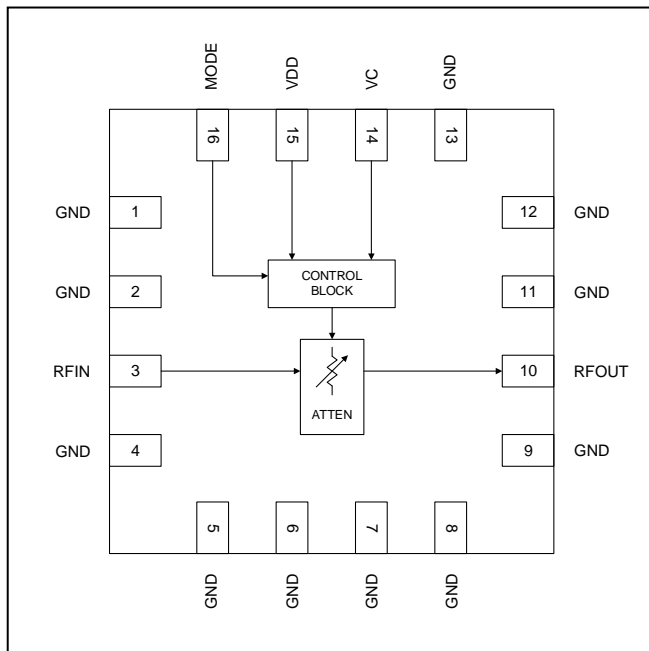

Top View

### Key Features

- Patented Circuit Architecture
- Over 25dB of attenuation range
- Frequency range of 5MHz to 3000MHz
- Low insertion loss of 1.2dB at 1200MHz
- Operates over wide supply voltage range of 3V to 5.5V
- Supply current: 5mA (typical)
- Excellent distortion characteristics with IIP3 > 45dBm
- Linear in dB control characteristic
- High 1dB Compression Point > +30dBm

### Applications

- DOCSIS 4.0 Equalizer Circuits
- DOCSIS 4.0 Attenuator
- DOCSIS 4.0 Amplifier and Nodes
- Cable Modems
- CATV/DOCSIS Amps and Nodes
- High Linearity Power Control
- RPHY and RPHY Shelf applications

### Ordering Information

Part No.	Description
QPC4043SB	Sample Bag with 5 Pieces
QPC4043SR	7" Reel with 100 Pieces
QPC4043TR7	7" Reel with 2500 Pieces
QPC4043EV01	5 – 3000MHz PCBA

## Absolute Maximum Ratings

Parameter	Rating
Supply Voltage (V <sub>DD</sub> )	-0.5 to +6.0V
Control Voltage (V <sub>c</sub> )	-0.5 to +6.0V
Mode Voltage (MODE)	-0.5 to +6.0V
Maximum RF Input Power	+20dBm
Storage Temperature Range	-65 to +150°C
Exceeding any one or a combination of the Absolute Maximum Rating conditions may cause permanent damage to the device. Extended application of Absolute Maximum Rating conditions to the device may reduce device reliability.	

## Recommended Operating Conditions

Parameter	Min	Typ	Max	Units
Supply Voltage, V <sub>DD</sub>	+3	+5.0	+5.5	V
Control Voltage, V <sub>c</sub>	0		+2.5	V
Mode Voltage, Pos. Slope	1.0			V
Mode Voltage, Neg. Slope			0.4	V
Temperature Range	-40		+105 <sup>(2)</sup>	°C
Junction Temperature			+125	°C

- (1) Electrical specifications are measured at specified test conditions. Specifications are not guaranteed over all recommended operating conditions.
- (2) RF input power handling derates above 85 °C

## Electrical Specifications

Parameter	Condition <sup>(1)</sup>	Min	Typ	Max	Unit
Supply Current (I <sub>DD</sub> )	Steady state operation, current draw during attenuation state transitions is higher.		5		mA
Control Current (I <sub>c</sub> )	Steady state operation, current draw during attenuation state transitions is higher.		50		μA
Frequency Range		5		3000	MHz
Minimum Insertion Loss			1.5	2	dB
Attenuation Control Range		25			dB
Attenuation Slope			17		dB/V
Attenuation Delta Across Temperature	Relative attenuation ≤ 25 dB		1.2		dB
Relative Insertion Phase			2		deg/(dB GHz)
Input Return Loss			18		dB
Output Return Loss			18		dB
RF Input Power			15		dBm
Input P1dB			30		dBm
Input IP2	Frequency ≥ 50MHz	65			dBm
Input IP3		43			dBm
Settling Time	1dB step settling to 0.1dB of final value, relative attenuation <25dB		250		μS
Thermal Resistance			26		°C/W

### Notes:

- Typical performance at these conditions: Temp = +25°C, 1200MHz, V<sub>DD</sub> = +5V, 75Ω system
- IIP3 tone spacing = 1MHz; Pin = +15dBm

### Evaluation Board Schematic; 5 – 3000MHz

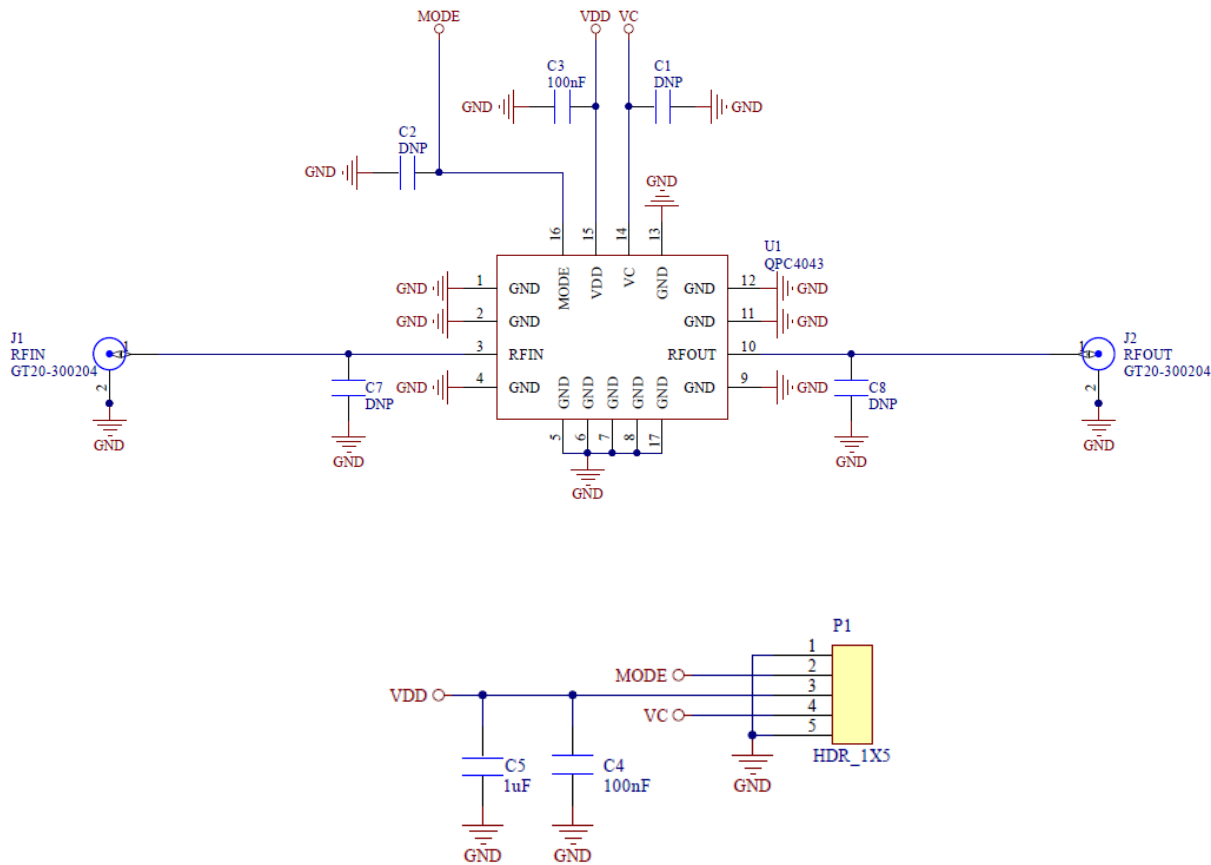

### Evaluation Board Bill of Materials

Ref Designator	Qty	Description	Manufacturer	Manufacturer Part #
	1	PCB, QPC4043	TTM Technologies, Inc.	QPC4043-4000(A)
C3, C4	2	CAP, 0.1uF, 10%, 16V, X7R, 0402	Kemet	C0402C104K4RACTU
C5	1	CAP, 1uF, 10%, 10V, X7S, 0402	MURATA	GRM155C71A105KE11D
P1	1	CONN, HDR, ST, 5-PIN, T/H	Molex	22-28-4053
J1, J2, J3, J4	4	CONN, F FEM EDGE MOUNT, 75 OHMS, 0.065	Genesis Technology USA	GT20-300204
C1, C2, C7, C8	4	Do Not Populate		

Evaluation Board Assembly Drawing

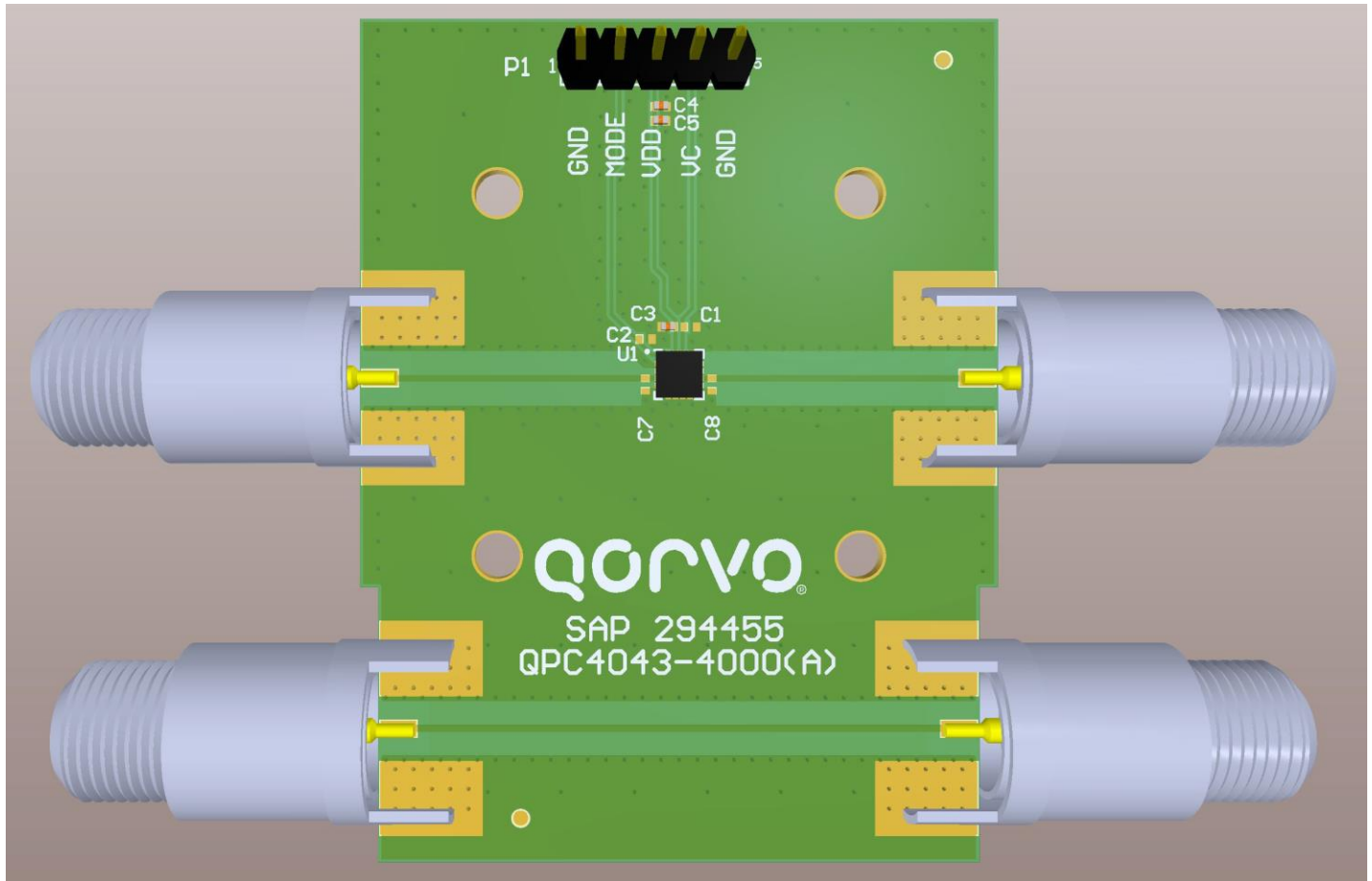

### Pin Configuration and Description

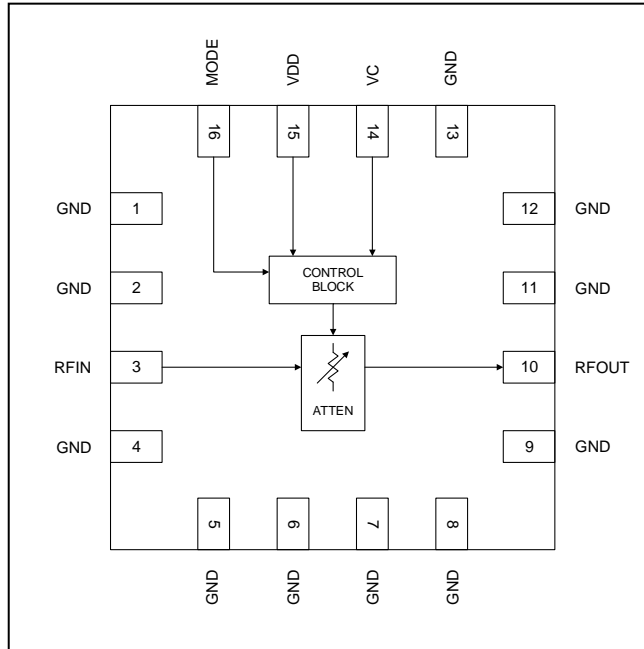

Top View

Pin	Label	Description
1	GND	Ground Pin - Pin is not connected internally, recommend connecting to ground
2	GND	Ground Pin - Pin is not connected internally, recommend connecting to ground
3	RFIN	RF input, use external DC block if external net is not grounded.
4	GND	Ground Pin - Pin is not connected internally, recommend connecting to ground
5	GND	Ground Pin - Pin is not connected internally, recommend connecting to ground
6	GND	Ground Pin - Pin is not connected internally, recommend connecting to ground
7	GND	Ground Pin - Pin is not connected internally, recommend connecting to ground
8	GND	Ground Pin - Pin is not connected internally, recommend connecting to ground
9	GND	Ground Pin - Pin is not connected internally, recommend connecting to ground
10	RFOUT	RF output, use external DC block if external net is not grounded.
11	GND	Ground Pin - Pin is not connected internally, recommend connecting to ground
12	GND	Ground Pin - Pin is not connected internally, recommend connecting to ground
13	GND	Ground Pin - Pin is not connected internally, recommend connecting to ground
14	VC	Attenuator control voltage
15	VDD	Supply voltage
16	MODE	Attenuation slope control Apply logic LOW to enable negative attenuation slope Apply logic HIGH to enable positive attenuation slope
Pkg Base	GND	Ground connection. The back side of the package should be connected to the ground plane though as short of a connection as possible. PCB vias under the device are recommended.

### Performance Plots

Test conditions unless otherwise noted:  $V_{DD} = +5V$ ,  $Temp = +25C$ ,  $Z_O = 75\Omega$

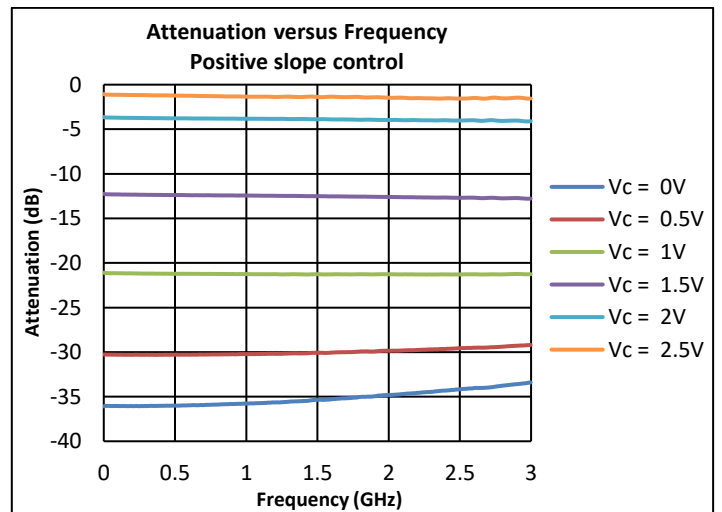
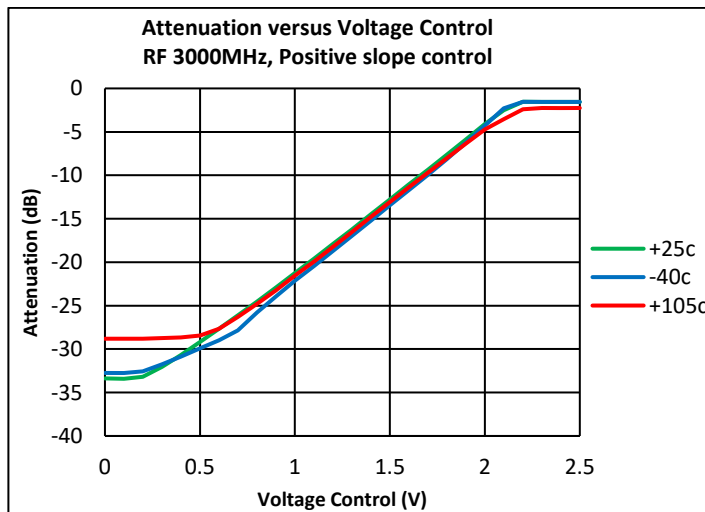
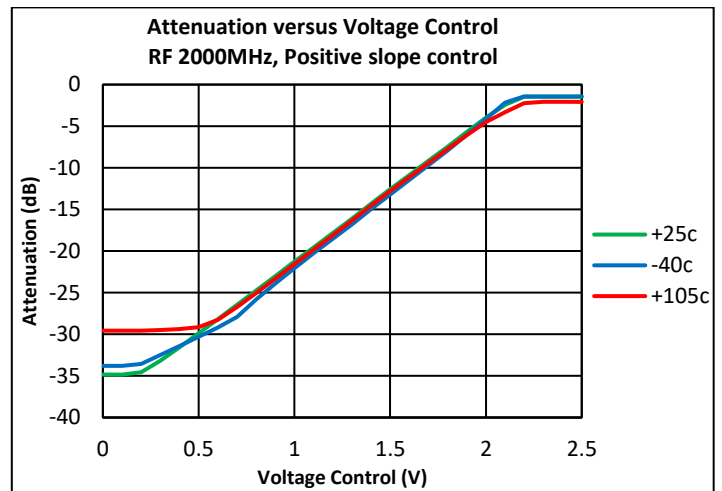
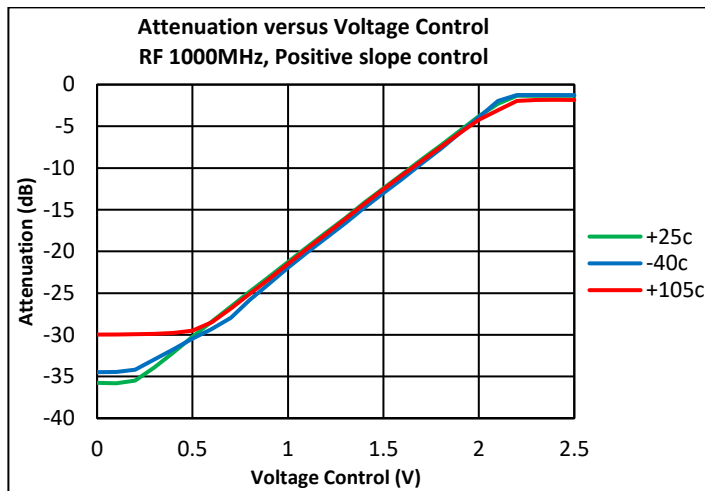
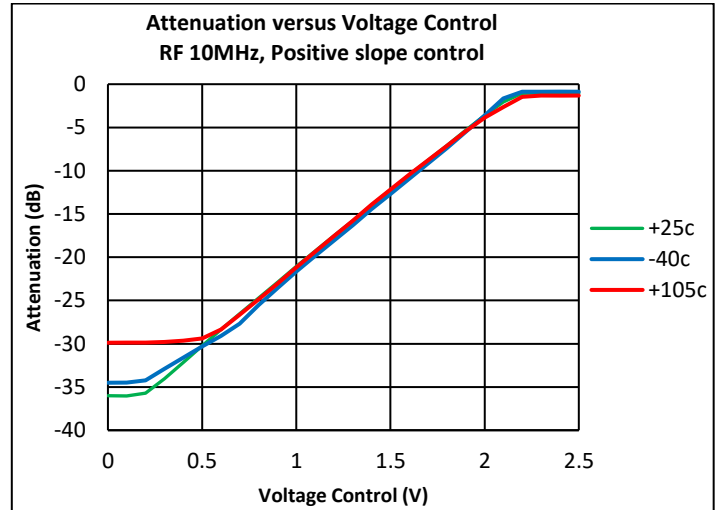
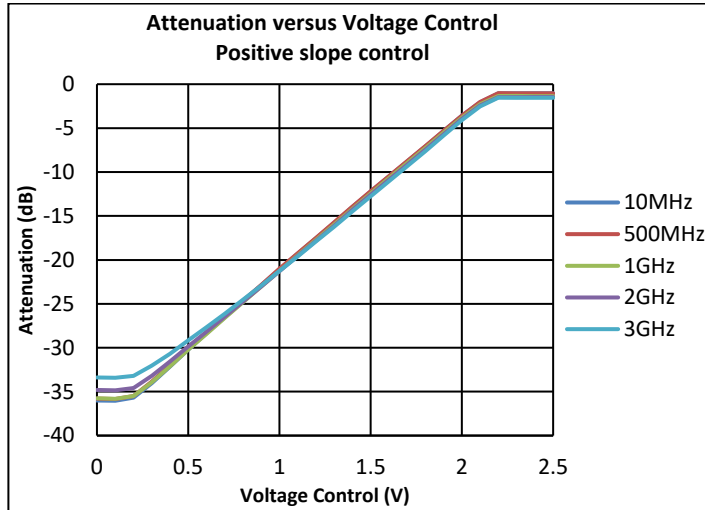

### Performance Plots (cont'd.)

Test conditions unless otherwise noted:  $V_{DD} = +5V$ ,  $Temp = +25C$ ,  $Z_O = 75\Omega$

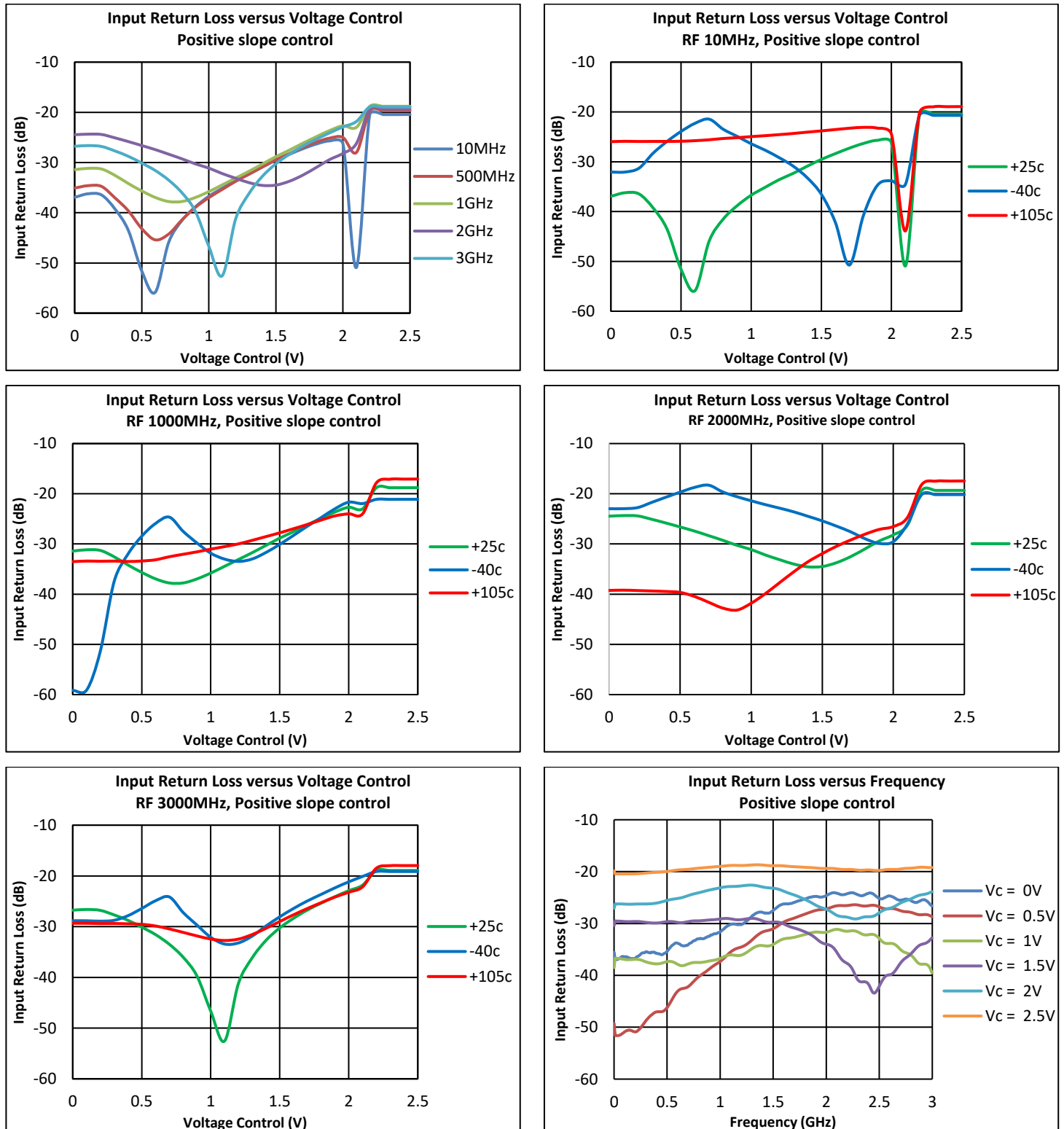

Performance Plots (cont'd.)

Test conditions unless otherwise noted:  $V_{DD} = +5V$ ,  $Temp = +25C$ ,  $Z_O = 75\Omega$

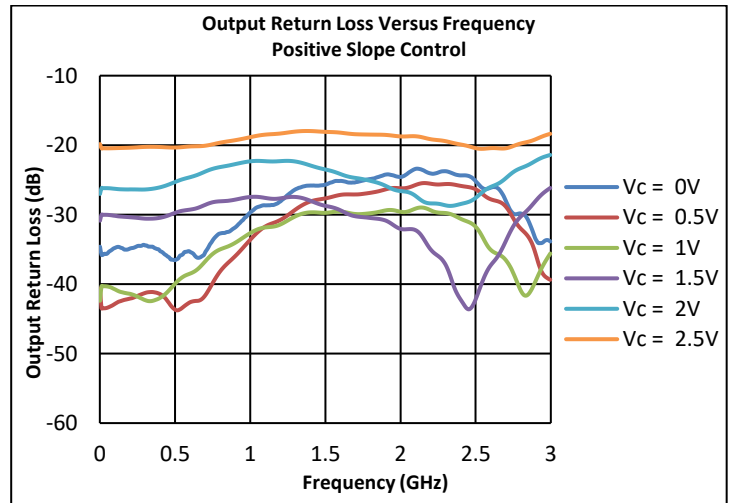
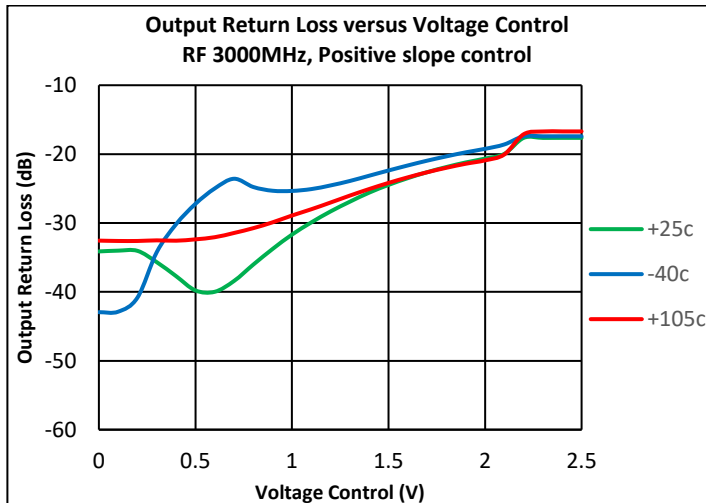
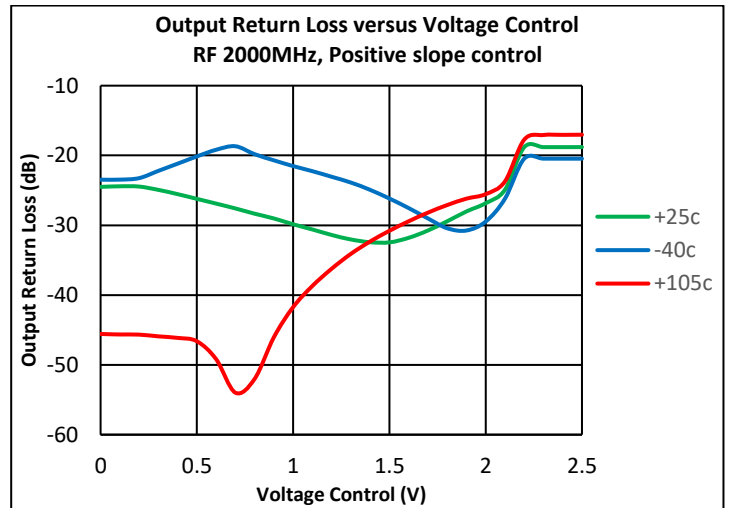
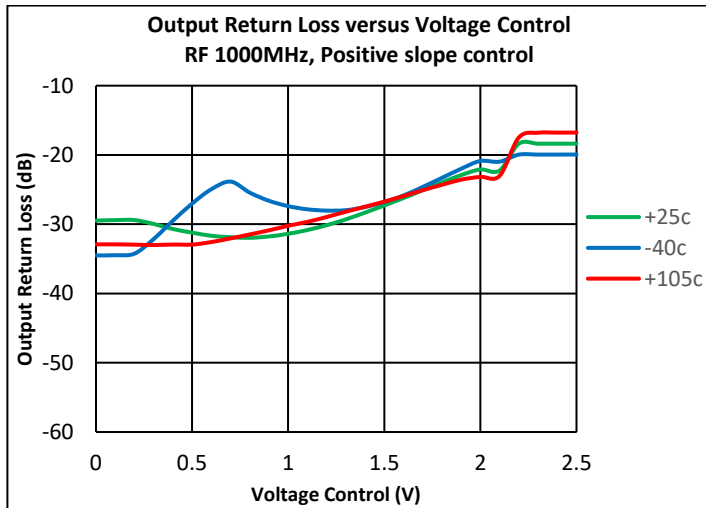
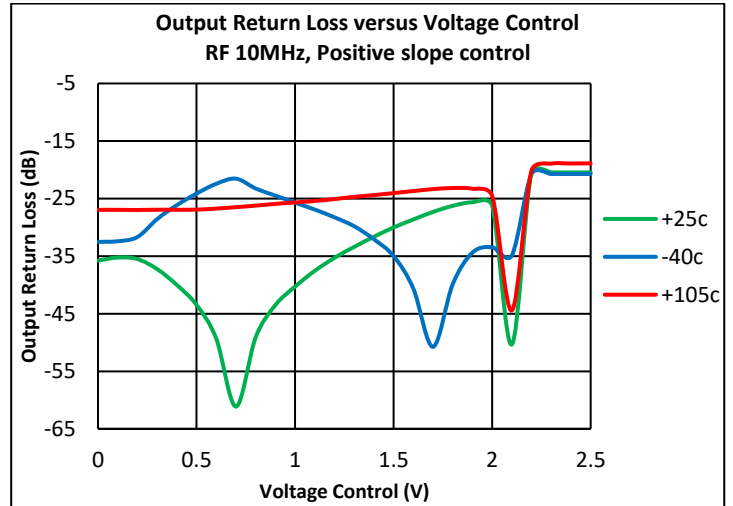
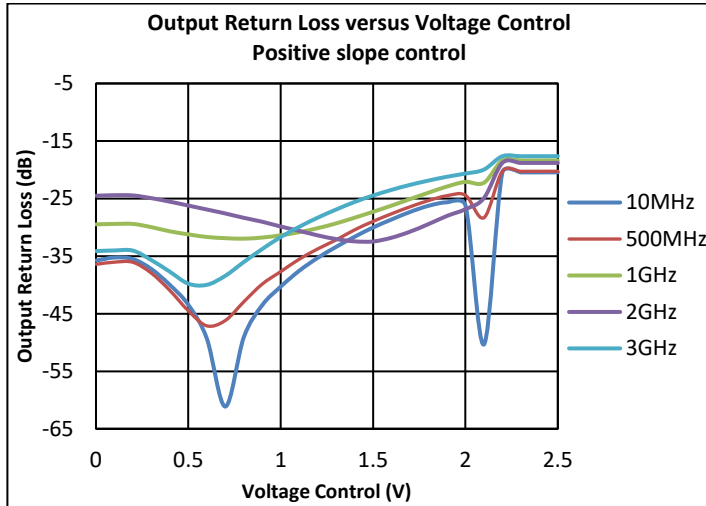



### Performance Plots (cont'd.)

Test conditions unless otherwise noted:  $V_{DD} = +5V$ ,  $Temp = +25C$ ,  $Z_O = 75\Omega$

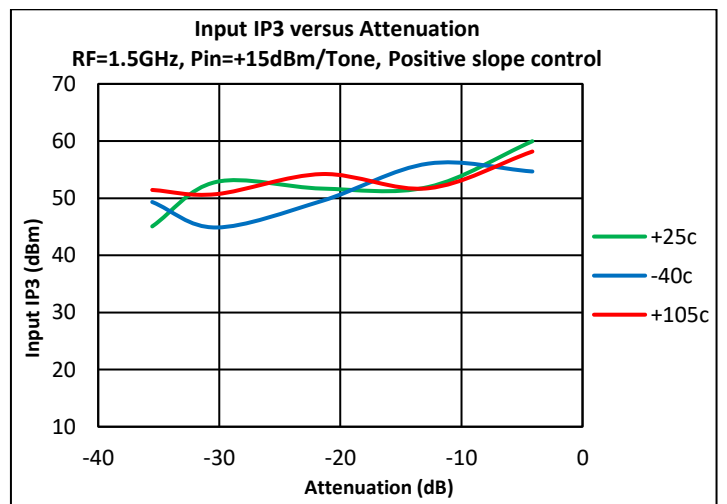
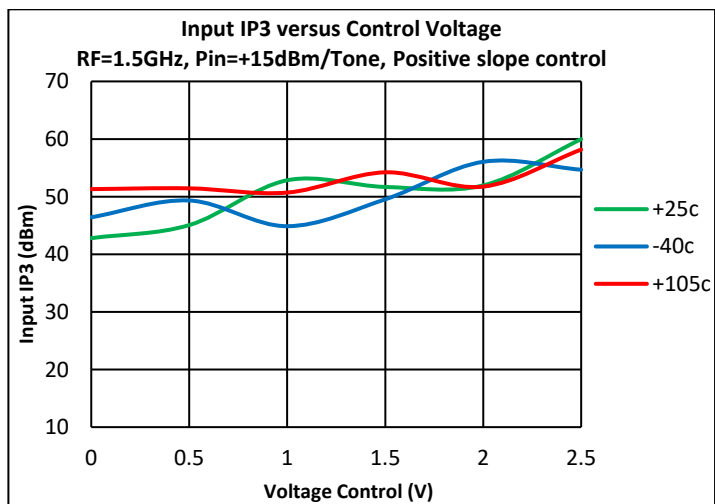
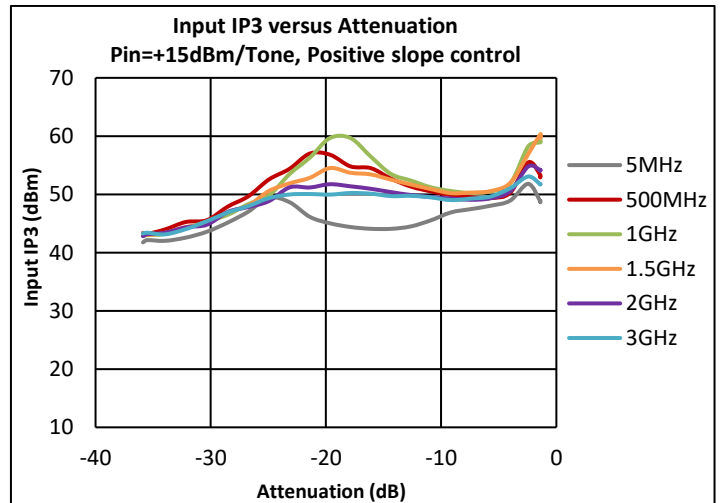
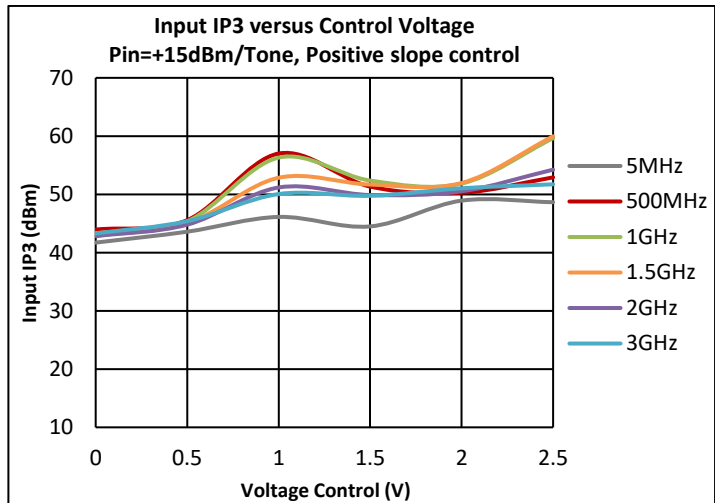
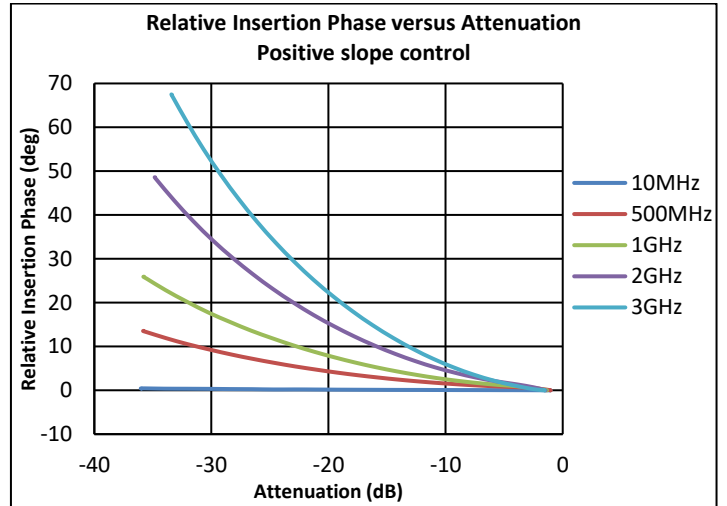
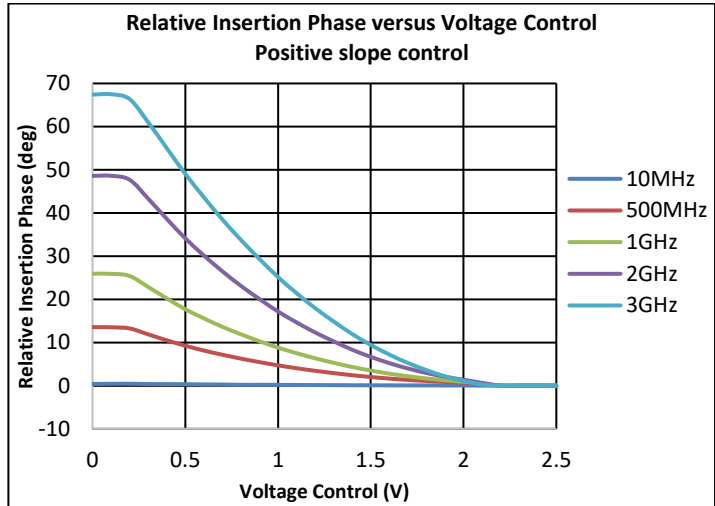

### Performance Plots (cont'd.)

Test conditions unless otherwise noted:  $V_{DD} = +5V$ ,  $Temp = +25C$ ,  $Z_O = 75\Omega$

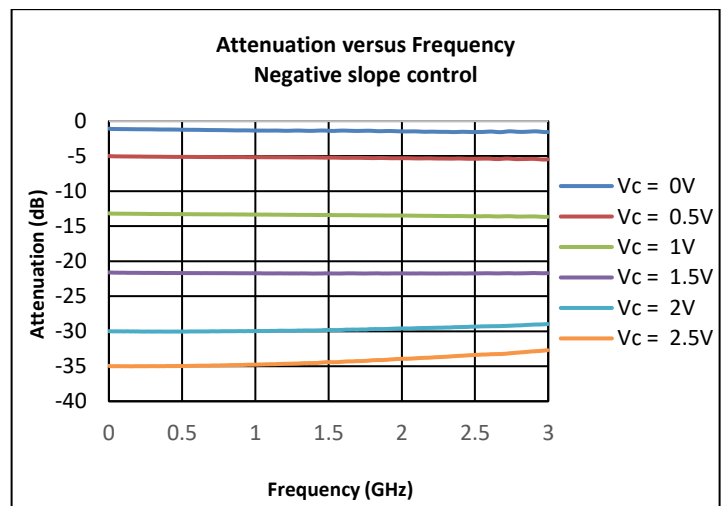
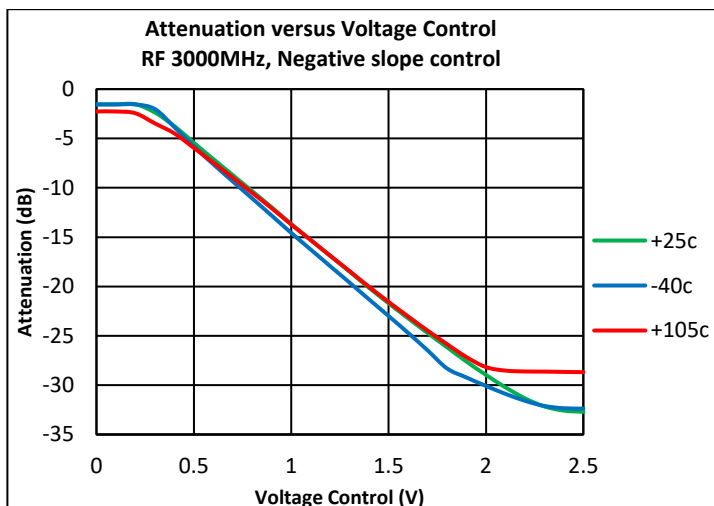
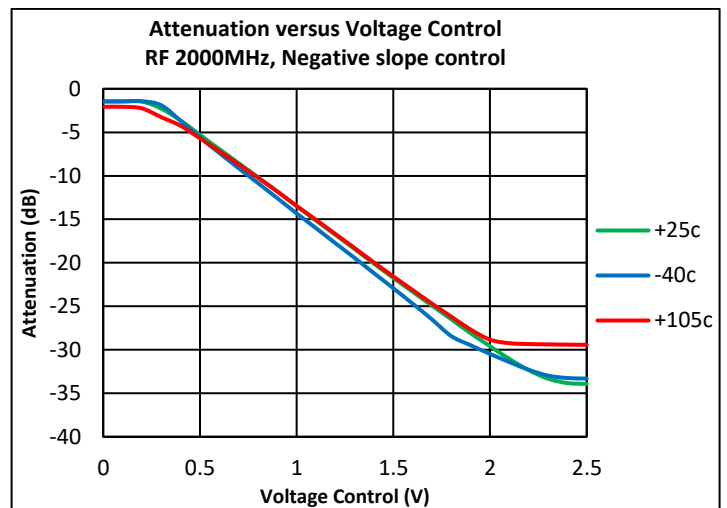
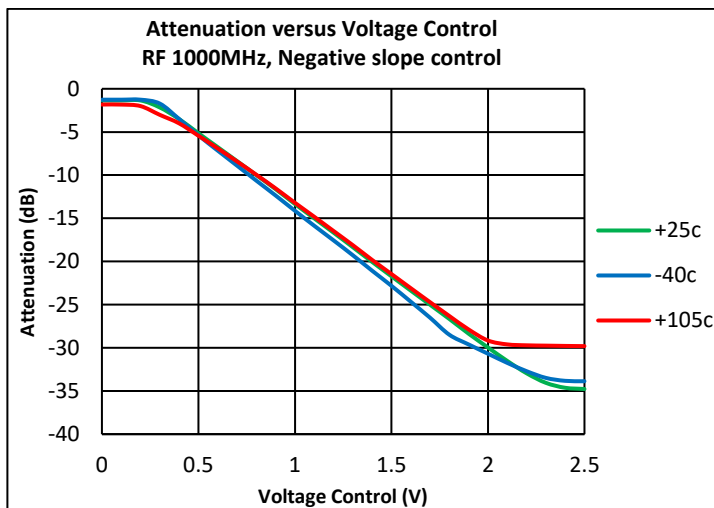
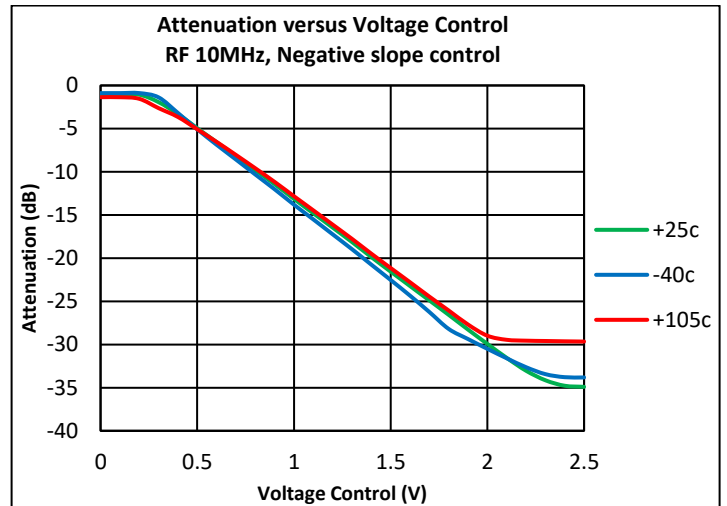
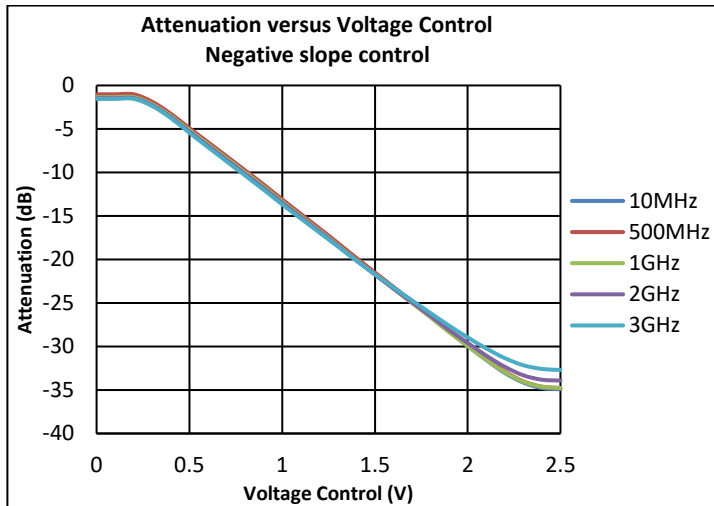

### Performance Plots (cont'd.)

Test conditions unless otherwise noted:  $V_{DD} = +5V$ ,  $Temp = +25C$ ,  $Z_O = 75\Omega$

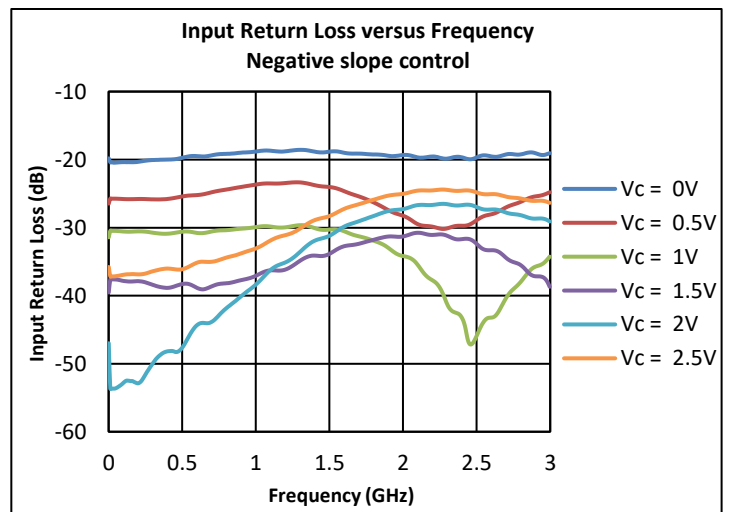
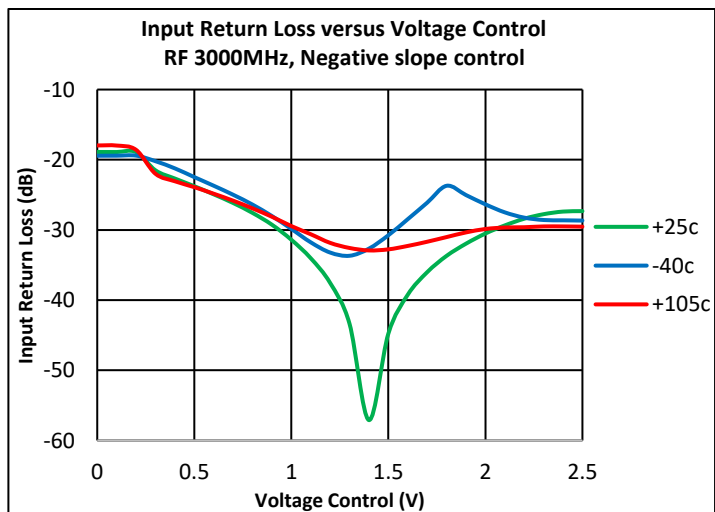
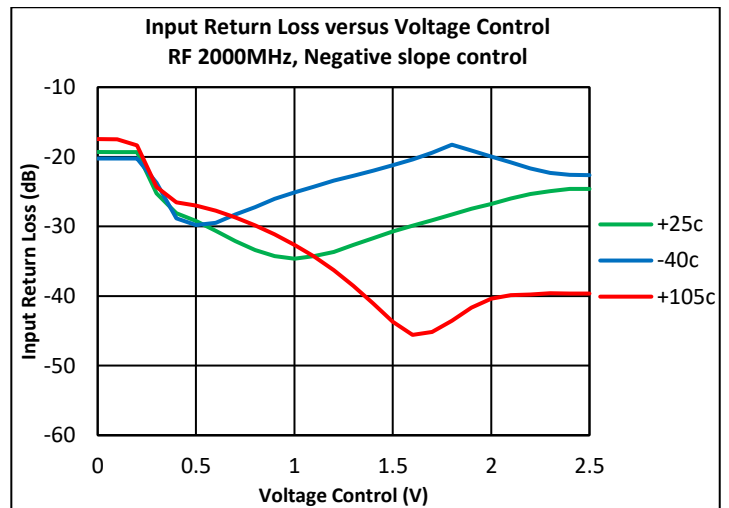
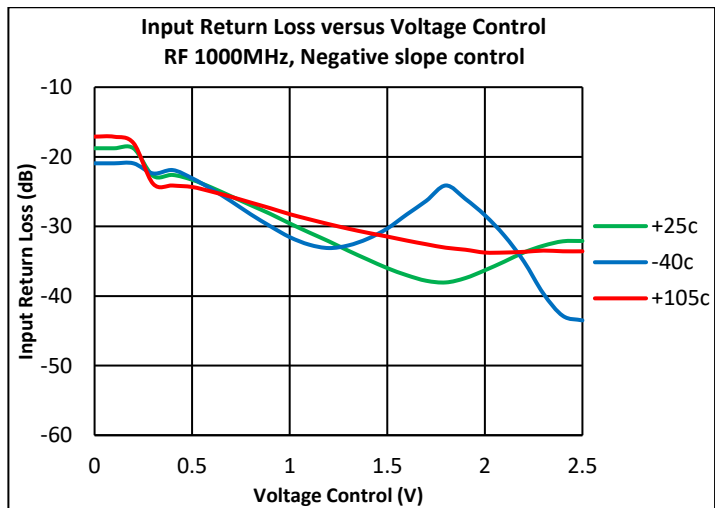
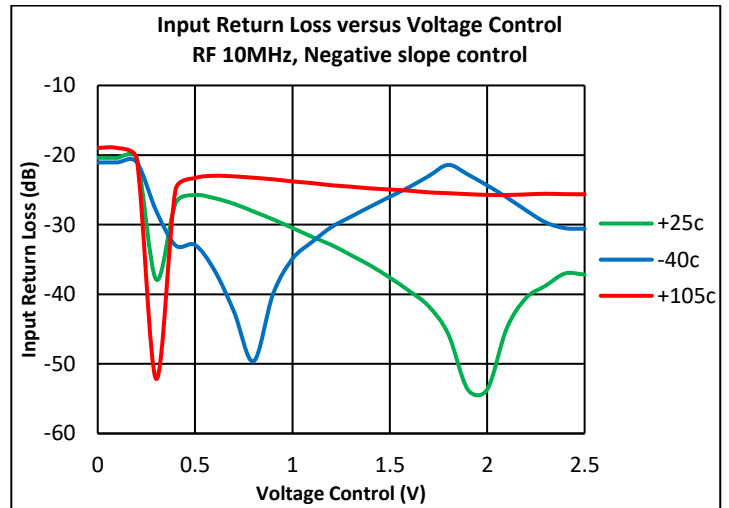
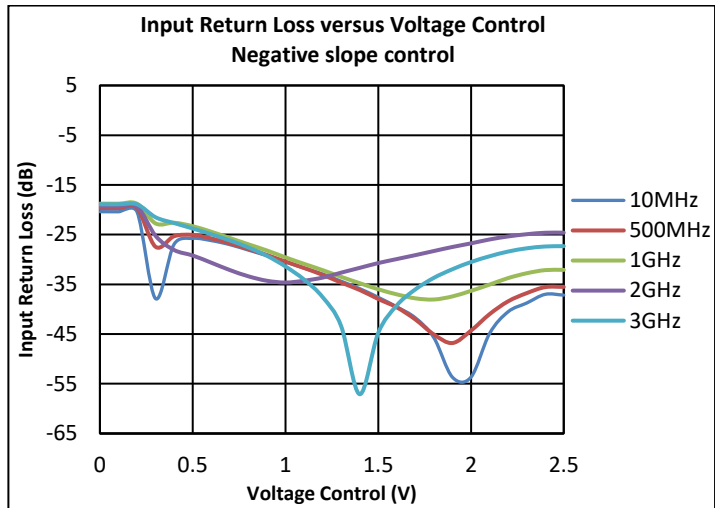

### Performance Plots (cont'd.)

Test conditions unless otherwise noted:  $V_{DD} = +5V$ ,  $Temp = +25C$ ,  $Z_O = 75\Omega$

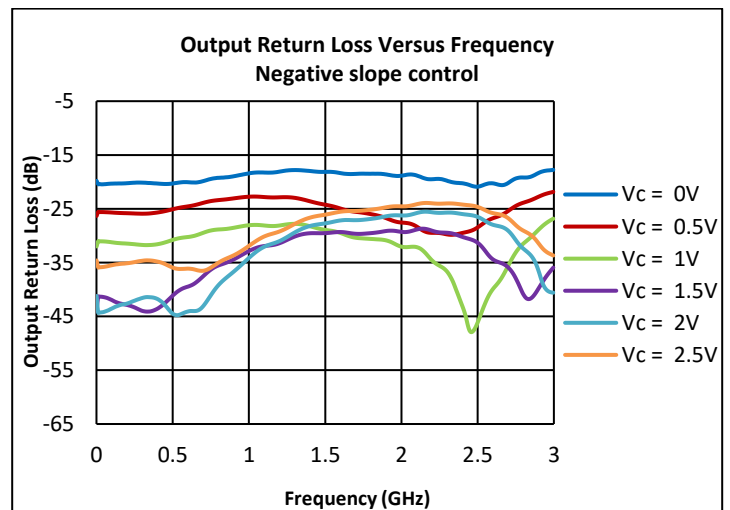
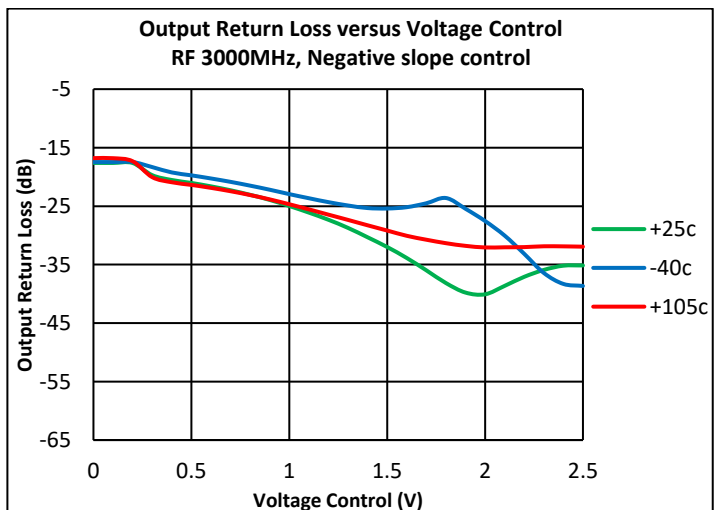
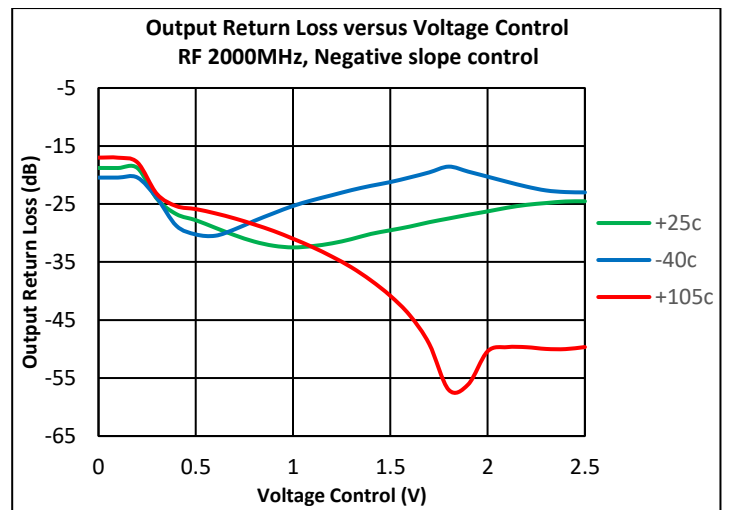
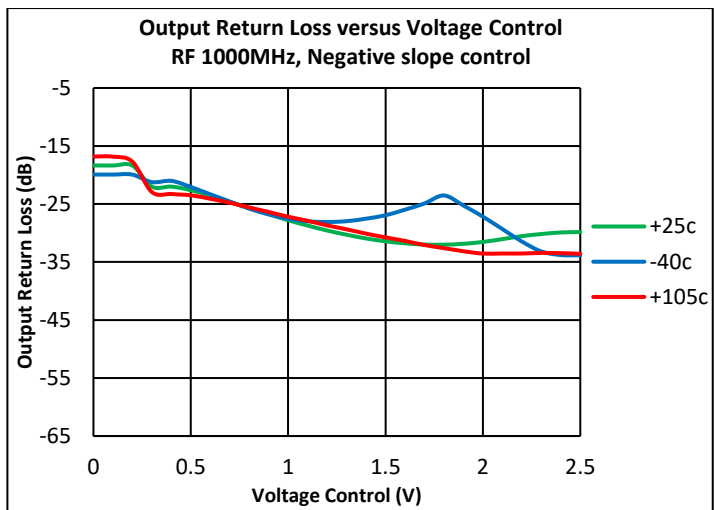
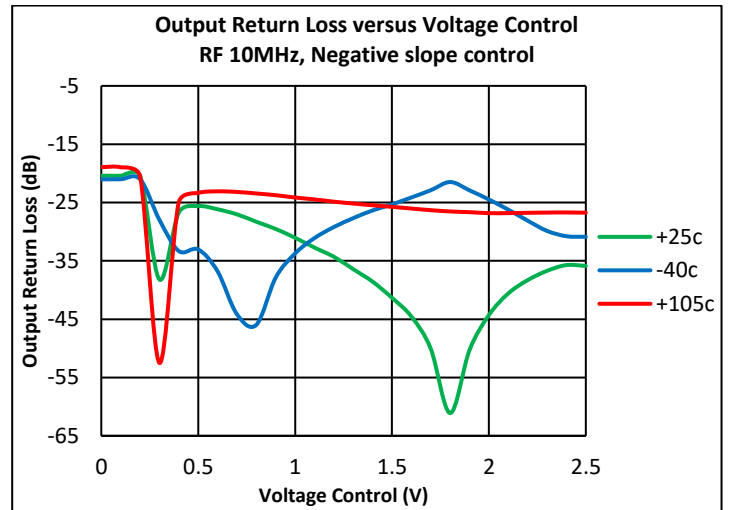
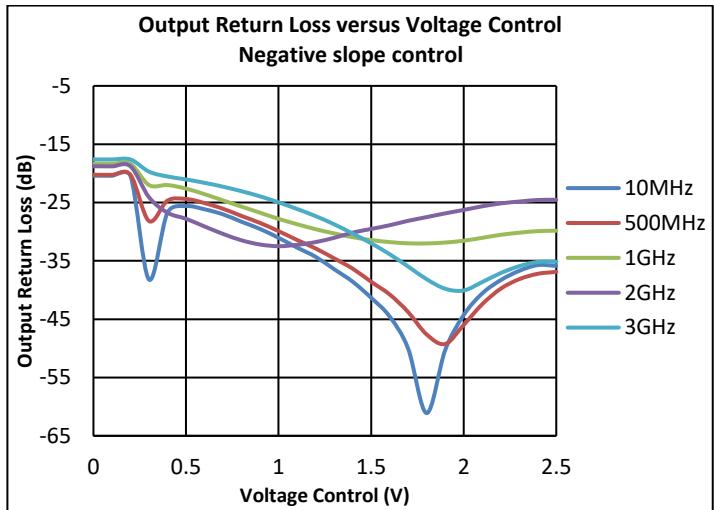

### Performance Plots (cont'd.)

Test conditions unless otherwise noted:  $V_{DD} = +5V$ ,  $Temp = +25C$ ,  $Z_O = 75\Omega$

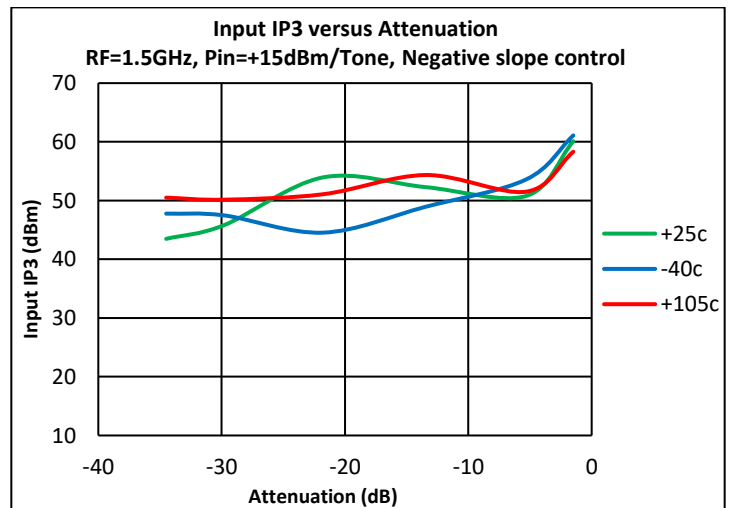
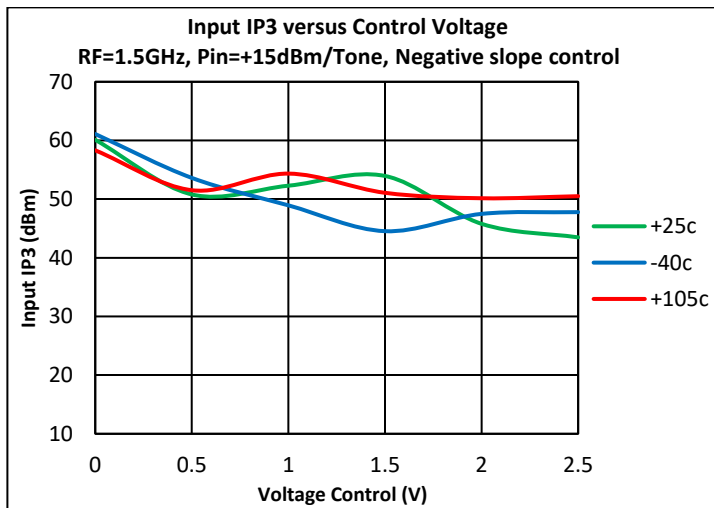
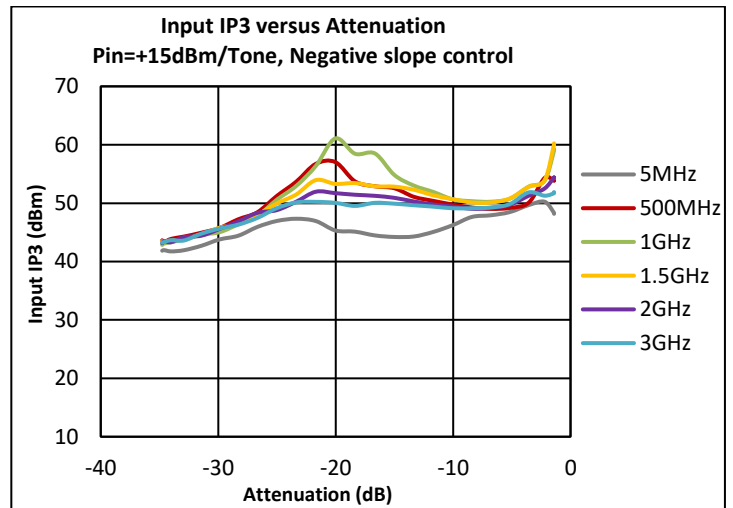
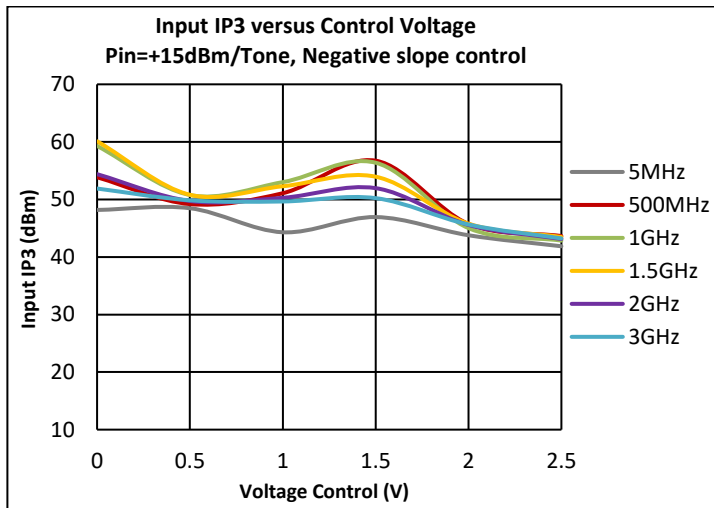
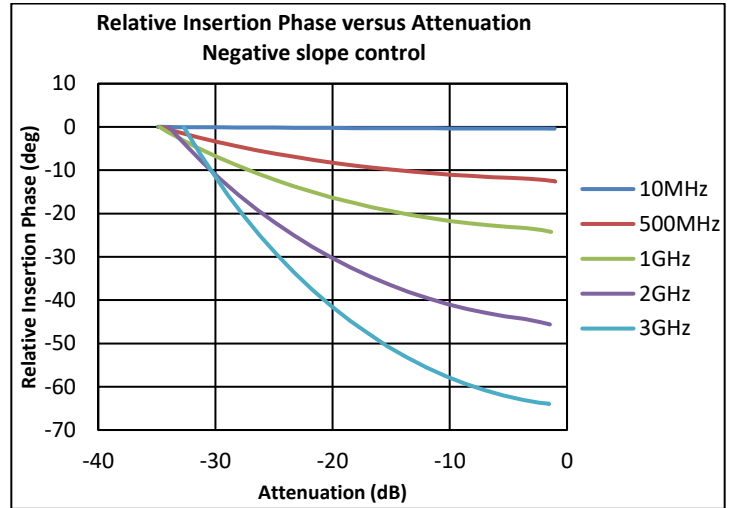
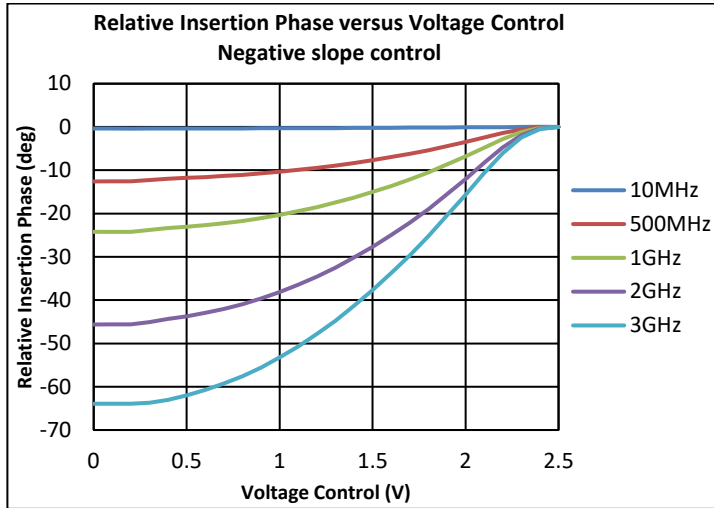

### Package Dimensions

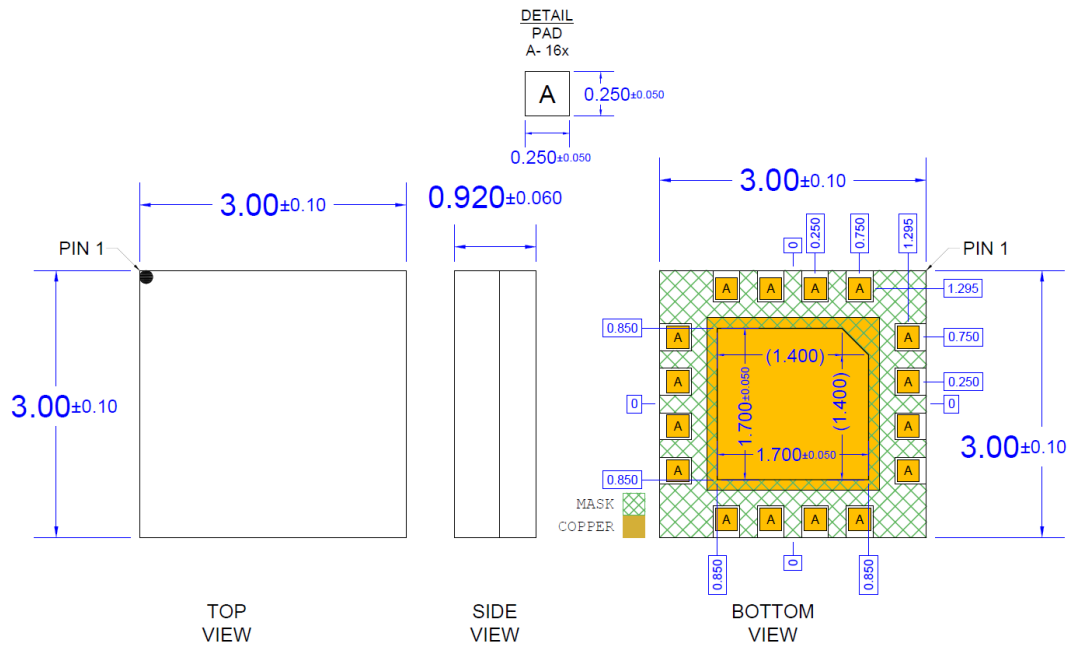

- Notes:
1. All dimensions are in millimeters. Angles are in degrees.
  2. Dimension and tolerance formats conform to ASME Y14.4M-1994.
  3. The terminal #1 identifier and terminal numbering conform to JESD 95-1 SPP-012.
  4. Contact plating: ENEPIG

### Recommended Mounting Pattern

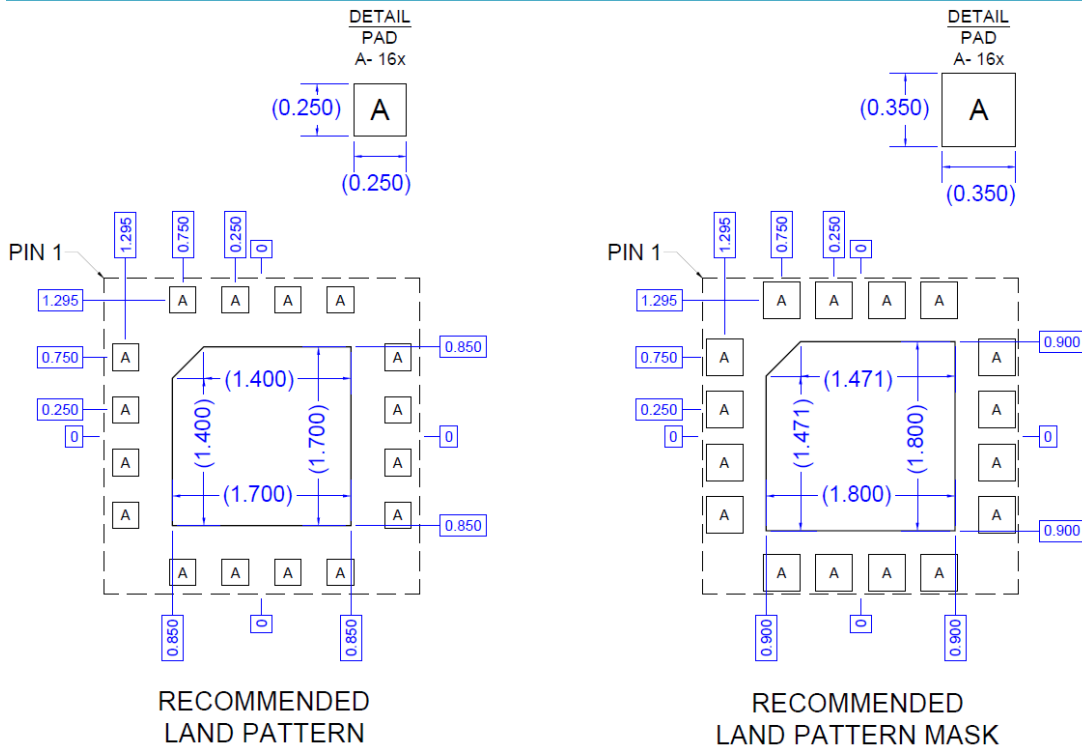

### Package Marking

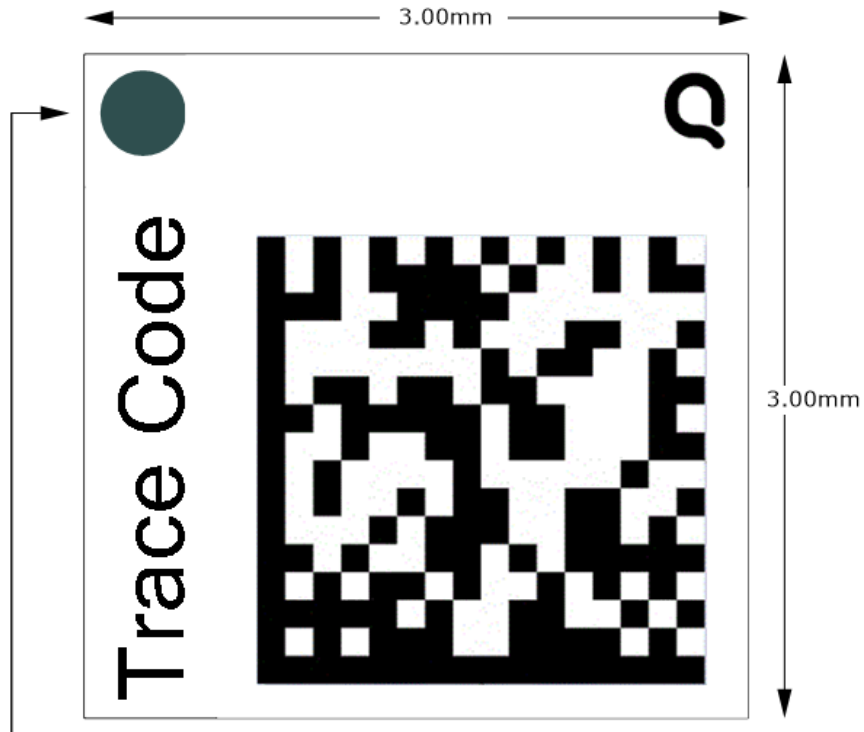

Pin 1 Indicator

Qorvo Logo - Use Q5D

Trace Code to be assigned by subcon

### Handling Precautions

Parameter	Rating	Standard
ESD – Human Body Model (HBM)	Class 1C (1000V)	ANSI/ESDA/JEDEC JS-001
ESD – Charged Device Model (CDM)	C2 (500V)	ANSI/ESDA/JEDEC JS-002
MSL – Moisture Sensitivity Level	MSL 3	IPC/JEDEC J-STD-020



Caution!  
ESD-Sensitive Device

### Solderability

Compatible with both lead-free (260°C max. reflow temp.) and tin/lead (245°C max. reflow temp.) soldering processes. Solder profiles available upon request.

Contact plating: ENEPIG

### RoHS Compliance

This part is compliant with 2011/65/EU RoHS directive (Restrictions on the Use of Certain Hazardous Substances in Electrical and Electronic Equipment) as amended by Directive 2015/863/EU.

This product also has the following attributes:

- Lead Free
- Halogen Free (Chlorine, Bromine)
- Antimony Free
- TBBP-A (C<sub>15</sub>H<sub>12</sub>Br<sub>4</sub>O<sub>2</sub>) Free
- PFOS Free
- SVHC Free



### Contact Information

For the latest specifications, additional product information, worldwide sales and distribution locations:

**Tel:** 1-844-890-8163

**Web:** [www.qorvo.com](http://www.qorvo.com)

**Email:** [customer.support@qorvo.com](mailto:customer.support@qorvo.com)





## Important Notice

---

The information contained in this Data Sheet and any associated documents (“Data Sheet Information”) is believed to be reliable; however, Qorvo makes no warranties regarding the Data Sheet Information and assumes no responsibility or liability whatsoever for the use of said information. All Data Sheet Information is subject to change without notice. Customers should obtain and verify the latest relevant Data Sheet Information before placing orders for Qorvo® products. Data Sheet Information or the use thereof does not grant, explicitly, implicitly or otherwise any rights or licenses to any third party with respect to patents or any other intellectual property whether with regard to such Data Sheet Information itself or anything described by such information.

DATA SHEET INFORMATION DOES NOT CONSTITUTE A WARRANTY WITH RESPECT TO THE PRODUCTS DESCRIBED HEREIN, AND QORVO HEREBY DISCLAIMS ANY AND ALL WARRANTIES WITH RESPECT TO SUCH PRODUCTS WHETHER EXPRESS OR IMPLIED BY LAW, COURSE OF DEALING, COURSE OF PERFORMANCE, USAGE OF TRADE OR OTHERWISE, INCLUDING THE IMPLIED WARRANTIES OF MERCHANTABILITY AND FITNESS FOR A PARTICULAR PURPOSE. Without limiting the generality of the foregoing, Qorvo® products are not warranted or authorized for use as critical components in medical, life-saving, or life-sustaining applications, or other applications where a failure would reasonably be expected to cause severe personal injury or death. Applications described in the Data Sheet Information are for illustrative purposes only. Customers are responsible for validating that a particular product described in the Data Sheet Information is suitable for use in a particular application.

© 2022 Qorvo US, Inc. All rights reserved. This document is subject to copyright laws in various jurisdictions worldwide and may not be reproduced or distributed, in whole or in part, without the express written consent of Qorvo US, Inc. | QORVO® is a registered trademark of Qorvo US, Inc.

## X-ON Electronics

Largest Supplier of Electrical and Electronic Components

*Click to view similar products for [RF Development Tools](#) category:*

*Click to view products by [Qorvo](#) manufacturer:*

Other Similar products are found below :

[MAAP-015036-DIEEV2](#) [EV1HMC637ALP5](#) [EVAL-ADF7241DB1Z](#) [ADL5363-EVALZ](#) [LMV228SDEVAL](#) [SKYA21001-EVB](#) [MAAL-011111-000SMB](#) [MAAM-009633-001SMB](#) [MASW-000936-001SMB](#) [107780-HMC322ALP4](#) [SP000416870](#) [TQP4M9071-PCB-IF](#) [EV1HMC244AG16](#) [EVAL01-HMC190BMS8](#) [122763-HMC635LC4](#) [MAX2837EVKIT+](#) [MAX2692EVKIT#](#) [SKY12343-364LF-EVB](#) [MAX2016EVKIT](#) [MAX2204EVKIT+](#) [SIMSA868-DKL](#) [SIMSA868C-DKL](#) [SKY65806-636EK1](#) [SKY68020-11EK1](#) [SKY66181-11-EK1](#) [SKY65804-696EK1](#) [SKY13396-397LF-EVB](#) [SKY13380-350LF-EVB](#) [SKY13355-374LF-EVB](#) [SKY12210-478LF-EVB](#) [SKY12207-478LF-EVB](#) [SE5004L-EK1](#) [CLA4609-086-EVB](#) [SIMSA915C-DKL](#) [SIMSA915-DKL](#) [SIMSA433C-DKL](#) [SKY12212-478LF-EVB](#) [EVK-R202-00B](#) [RF1624PCK-410](#) [SKYA21003-EVB](#) [SKY85331-11EK1](#) [ADP-R202-00B](#) [GRF4042-EVB](#) [SKY13626-685LF-EVB](#) [SKY13636-695EK1](#) [SKY13638-700EK1](#) [SKY66298-11-EVB](#) [SKY68000-31EK1](#) [SKY85310-11EK1](#) [SKY85310-21EK1](#)