

General Description

The QPC4270 is a high isolation Silicon on Insulator (SOI) single pole single throw (SPST) 75Ω absorptive switch designed for use in CATV, satellite set top and other high-performance communications systems.

Featuring a single supply with a single CMOS/TTL compatible control line, QPC4270 features low insertion loss and high isolation throughout its bandwidth making it an optimal choice for operation from 1MHz to 3.3GHz. QPC4270 offers excellent linearity and power handling capability thanks to its SOI process and does not require blocking caps on the RF ports if DC is not present on the RF ports. QPC4270 is packaged in a space saving 3.0 x 3.0 mm 6 lead DFN.

Functional Block Diagram

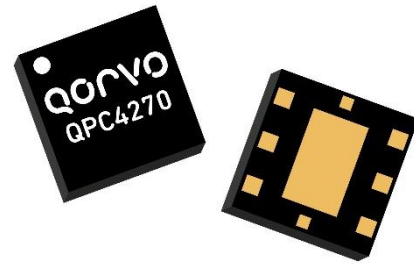
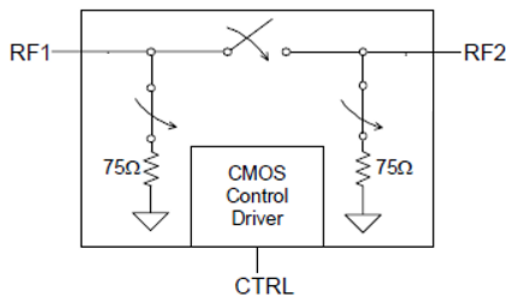

3.0 x 3.0mm 6-lead DFN

Product Features

- 1 to 3300MHz operation
- High Power Handling
- High Isolation: 96 dB at 5 MHz; 62 dB at 1000 MHz
- Low Insertion Loss: 0.17 dB at 50 MHz; 0.46dB at 1000 MHz
- 18dB Return Loss through 1.8GHz
- High Input IP2: 134.6 dBm at 1000MHz
- CMOS / TTL single-pin control
- Single supply operation from 2.7 to 5V

Applications

- Extended Spectrum DOCSIS
- CATV Amplifiers
- CATV Head End
- Fiber Deep Nodes
- Cable Set Top Box
- Satellite Set Top Box

Ordering Information

Part Number	Description
QPC4270SB	Sample Bag with 5 pieces
QPC4270SR	Short Reel with 100 pieces
QPC4270TR7	Standard 7" Reel with 2,500 pieces
QPC4270PCK-01	Fully Assembled 75 Ohm Evaluation Board and Sample Bag with 5 pieces

Absolute Maximum Ratings

Parameter	Rating
Storage Temperature	-65 to +150 °C
Operating Temperature	-40 to +105 °C
Maximum V _{DD}	6.0 V
Maximum CTRL	6.0 V

Exceeding any one or a combination of the Absolute Maximum Rating conditions may cause permanent damage to the device. Extended application of Absolute Maximum Rating conditions to the device may reduce device reliability.

Recommended Operating Conditions

Parameter	Min	Typ	Max	Units
Device Voltage (V _{DD})	+2.7	+3.0	+5.0	V
Device Current, 5V (I _{DD})		78	80	μA
Device Current, 3V (I _{DD})		55	57	
V _{CTRL High}	0.93		V _{DD}	V
V _{CTRL Low}	0		0.81	V

Electrical specifications are measured at specified test conditions. Specifications are not guaranteed over all recommended operating conditions.

Electrical Specifications

Parameter	Conditions ⁽¹⁾	Min	Typ	Max	Units
Operational Frequency Range ⁽¹⁾		1		3300	MHz
Insertion Loss	1 – 50 MHz		0.17		dB
	50-1000 MHz		0.29		dB
	1000-1800 MHz		0.41		dB
	1800-3300 MHz ⁽⁵⁾		0.97		dB
Isolation	1 – 50 MHz		94.4		dB
	50-1000 MHz		62.4		dB
	1000-1800 MHz		55.1		dB
	1800-3300 MHz ⁽⁵⁾		48		dB
Input Return Loss (Both Modes)	1 – 50 MHz		35		dB
	50-1000 MHz		23		dB
	1000-1800 MHz		18		dB
	1800-3300 MHz ⁽⁵⁾		12		dB
Output Return Loss (Both Modes)	1 – 50 MHz		35		dB
	50-1000 MHz		23		dB
	1000-1800 MHz		18		dB
	1800-3300 MHz ⁽⁵⁾		12		dB
1 dB Compression ^(2, 4)	Full Bandwidth		36		dBm
2 nd Harmonic	17MHz, 12dBm tone		-93.5		dBc
3 rd Harmonic	17MHz, 12dBm tone		-115.6		dBc
Output IP2	1000 MHz, 12dBm per tone		134.6		dBm
Output IP3	1000 MHz, 12dBm per tone		74.5		dBm
Video Feedthrough ⁽³⁾			4		mV _{PP}
Switching Time			11.9		μs

Notes:

1. Test conditions unless otherwise noted: V_{DD} = +3.0 V, Temp = +25 °C on QPC4270-4000(B) EVB
2. Measured in a 50 Ω system.
3. Measured with a 1 nS risetime, 0/3 V pulse and 500 MHz bandwidth.
4. Limited by absolute maximum power handling.
5. 1MHz to 3.3GHz application circuit (pg. 9)

Performance Plots; 1MHz to 1.8GHz Data

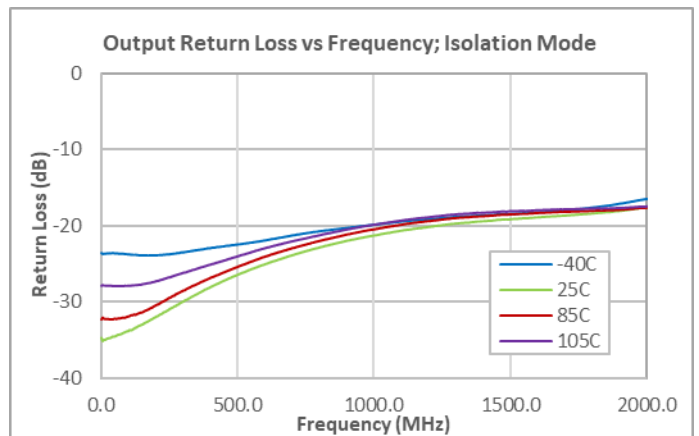
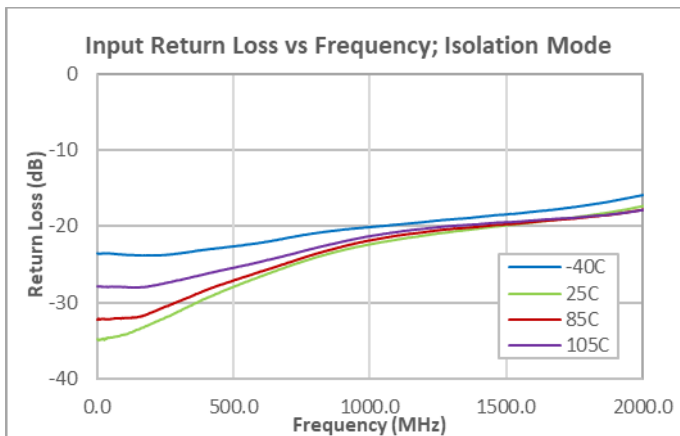
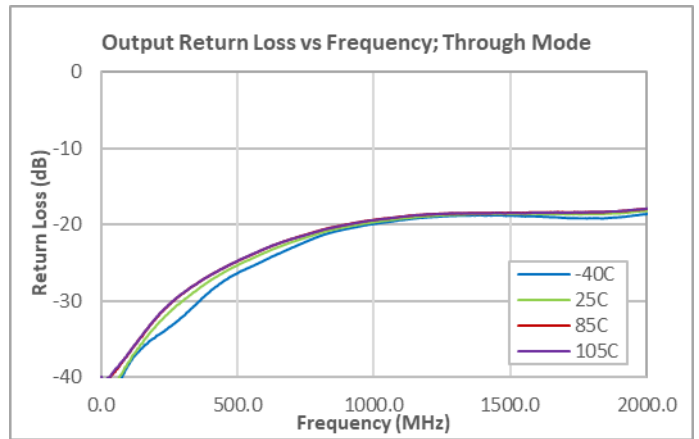
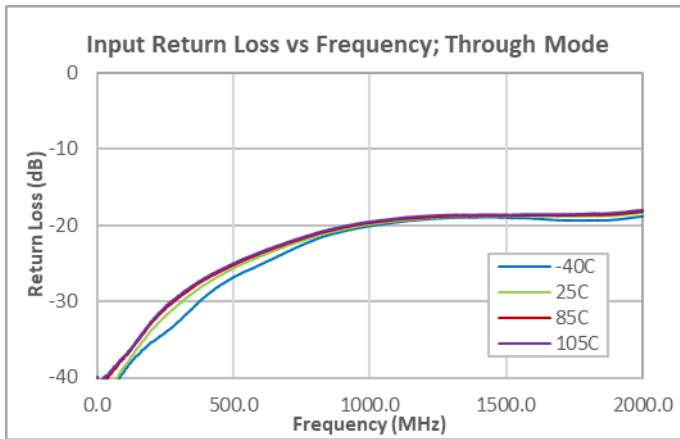
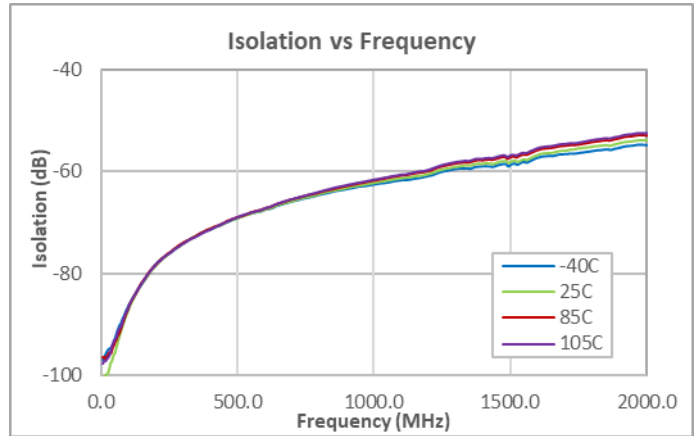
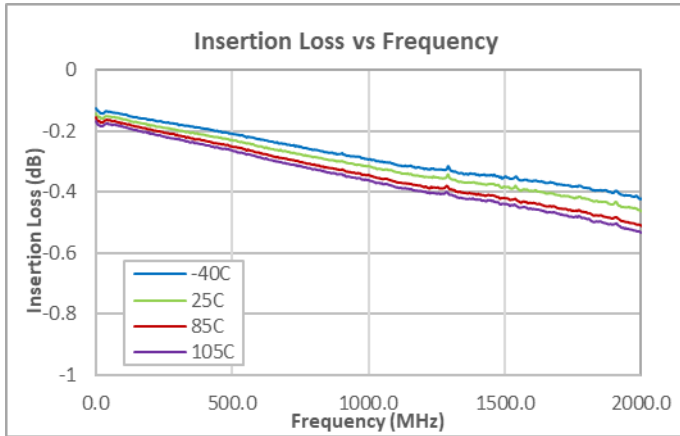

Test Conditions:

1. Test conditions unless otherwise noted: $V_{DD} = +3.0V$, $Z_0 = 75\Omega$, QPC4270-4000(B) EVB
2. Insertion Loss deembedded for EVB loss.

Performance Plots; 1MHz to 1.8GHz Data (cont'd.)

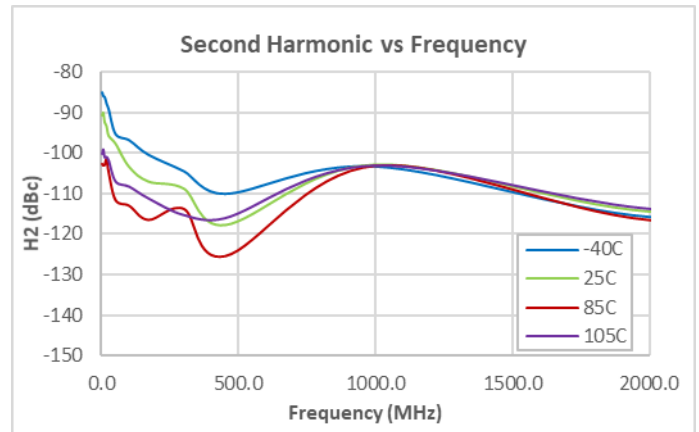
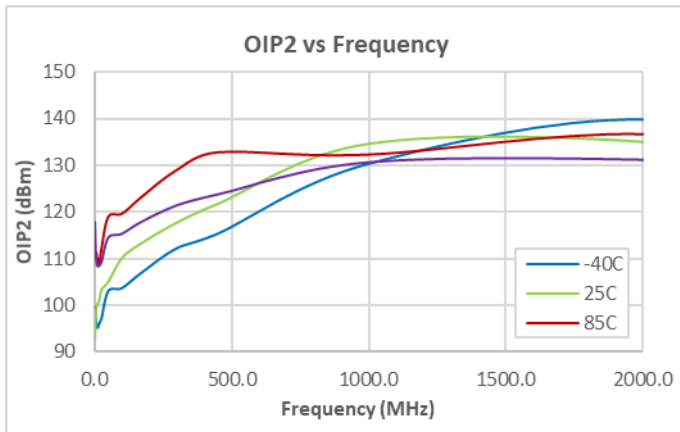
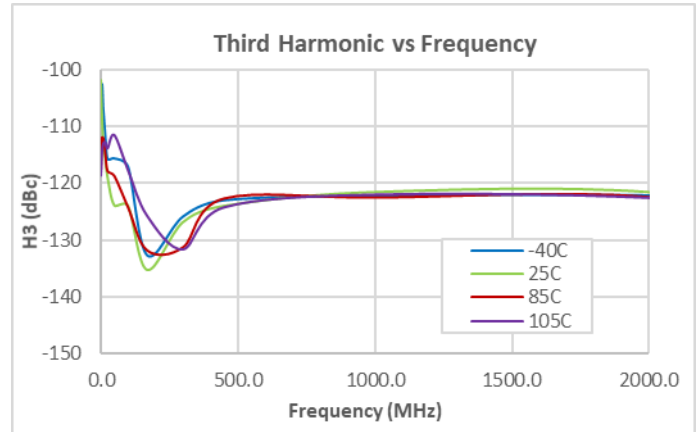
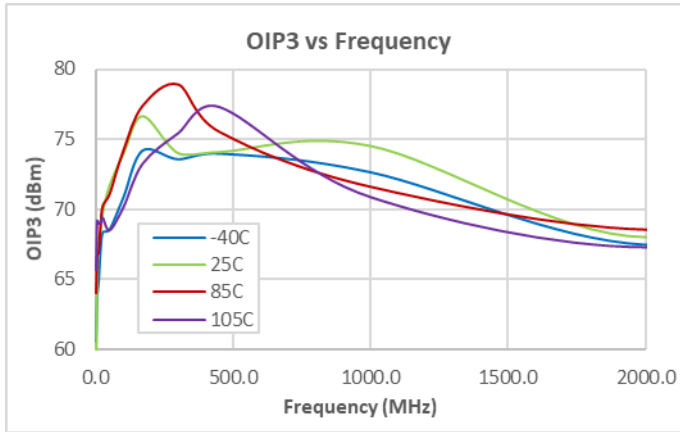

Test Conditions:

1. Test conditions unless otherwise noted: $V_{DD} = +3.0V$, $Z_0 = 75\Omega$, QPC4270-4000(B) EVB
2. IIP3, IP2: 75 μ W, +12dBm per Tone.

Performance Plots; 1MHz to 1.8GHz Data (cont'd.)

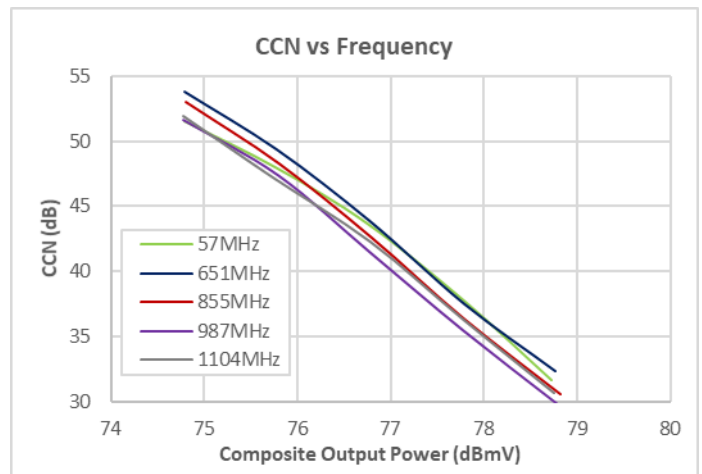
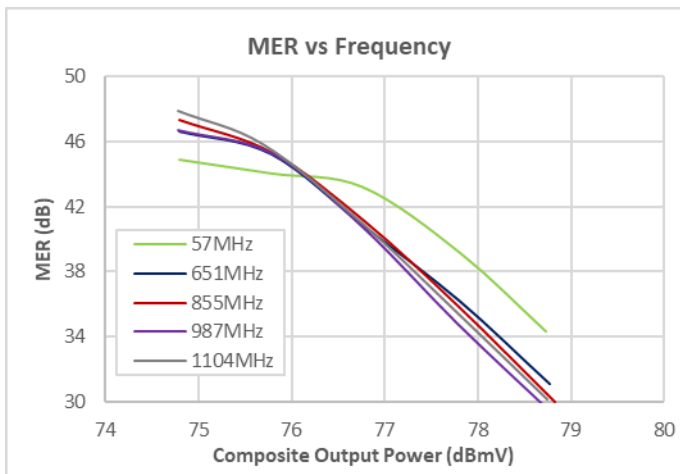
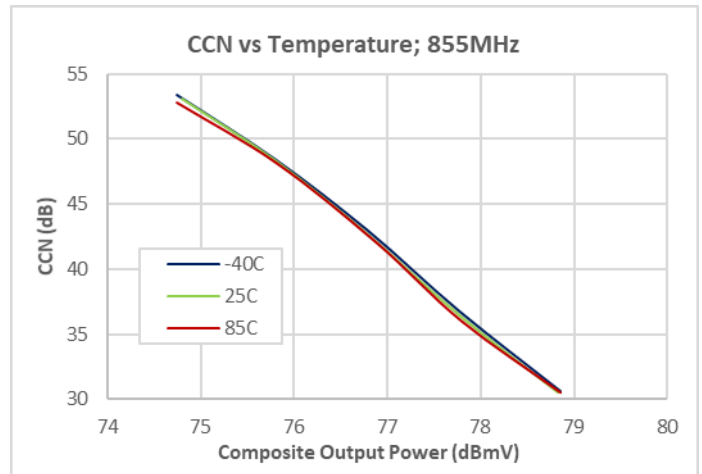
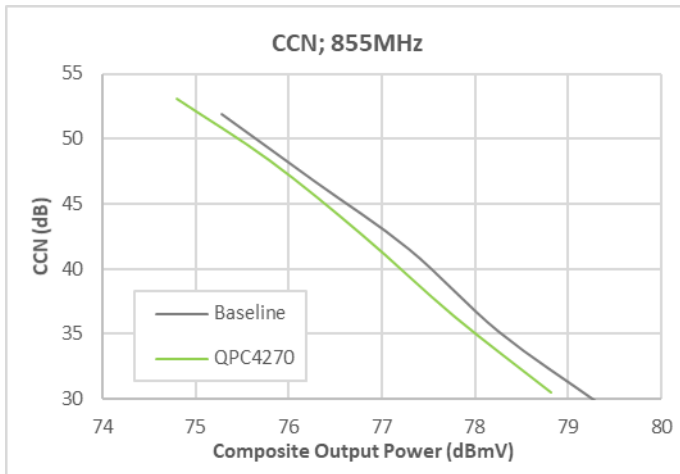
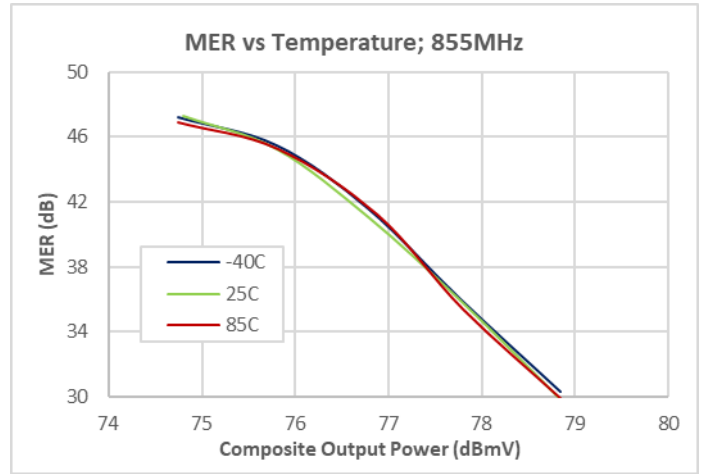
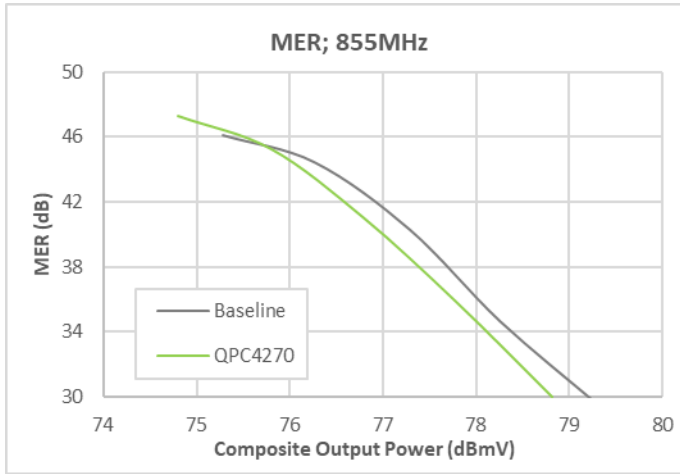

Test Conditions:

1. Test conditions unless otherwise noted: $V_{DD} = +5.0V$, $Z_o = 75\Omega$, QPC4270-4000(B) EVB
2. MER: 190 QAM Ch; 57-1215MHz; 10dB Tilt; ITU-T J.83, Annex B; Baseline represents RFPD3580 output.

Evaluation Board QPC4270-4000(B) Schematic; 1MHz to 1.8GHz

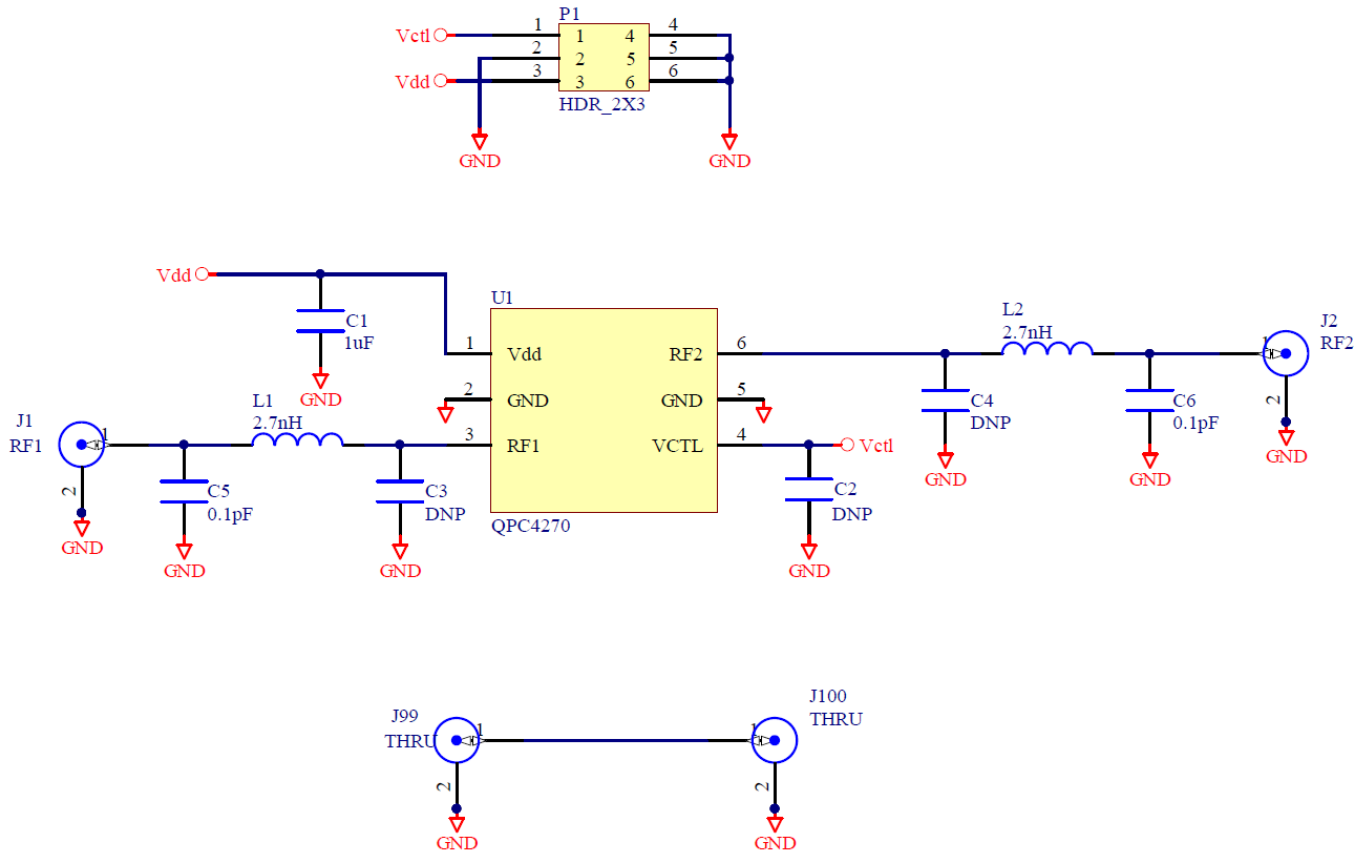

Evaluation Board QPC4270-4000(B) Bill of Materials; 1MHz to 1.8GHz

Ref Designator	Description	Manufacturer	Part Number
PCB	PCB, QPC4270	Qorvo	QPC4270-4000(B)
U1	QPC4270 Switch	Qorvo	QPC4270SB
C1	CAP, 1uF, 10%, 25V, X6S, 0402	Taiyo Uden PTE Ltd.	RM TMK105AC6105KV-F
C5, C6	CAP, 0.1pF, +/-0.05pF, 50V, HI-Q, 0402	Murata Electronics	GJM1555C1HR10WB01D
L1, L2	IND, 2.7nH, +/-0.3nH, M/L, 0402	Taiyo Uden PTE Ltd.	LG HK10052N7S
P1	CONN, HDR, RT ANG, 2x3, T/H	Samtec Inc.	TSW-103-08-G-D-RA
J1, J2, J99, J100	CONN, F FEM EDGE MOUNT, 75 OHMS, 0.065"	Genesis Technology USA	GT20-300204
C2, C3, C4	Not Populated		

Evaluation Board QPC4270-4000(B) Layout

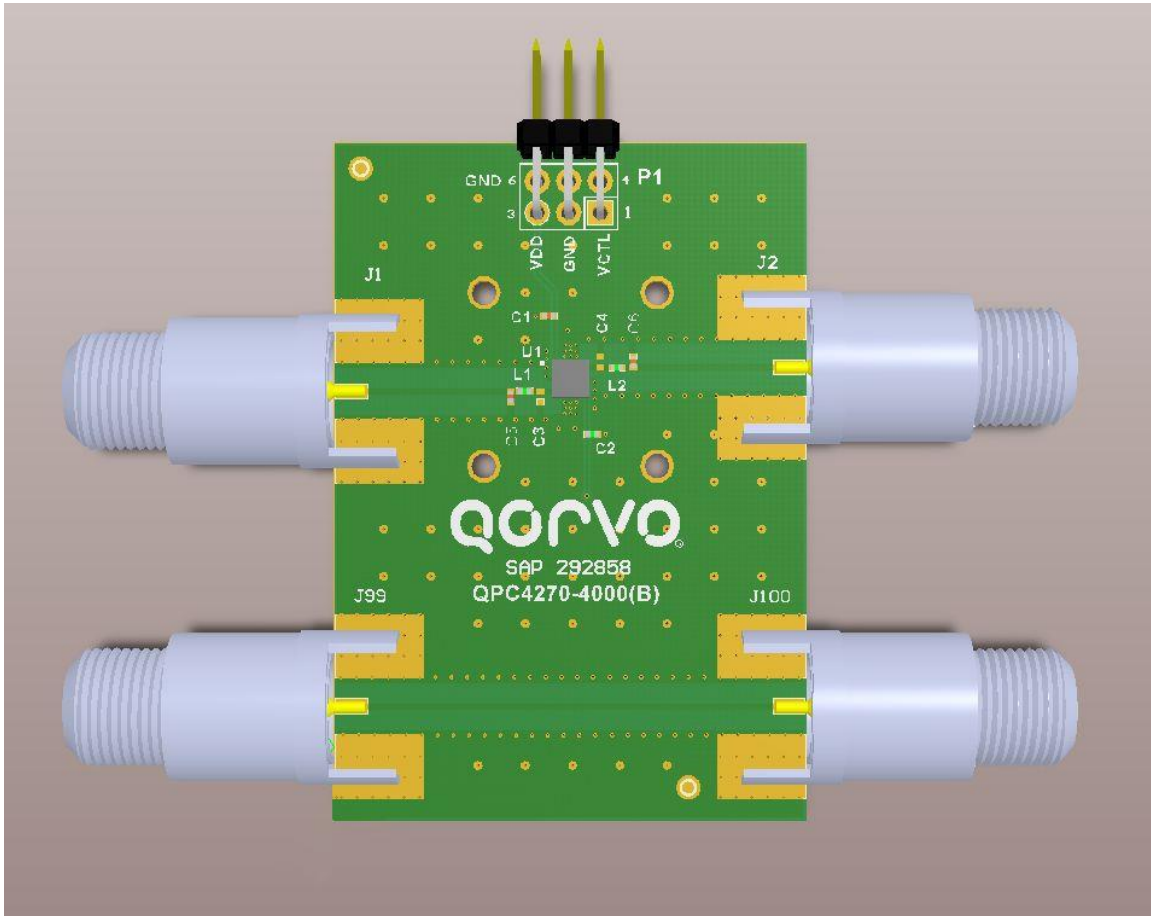

Control Logic Truth Table

Control Voltage (CTRL)	Signal Path (RF1 to RF2)
High	ON
Low	OFF

Typical Application Schematic; 1MHz to 1.8GHz

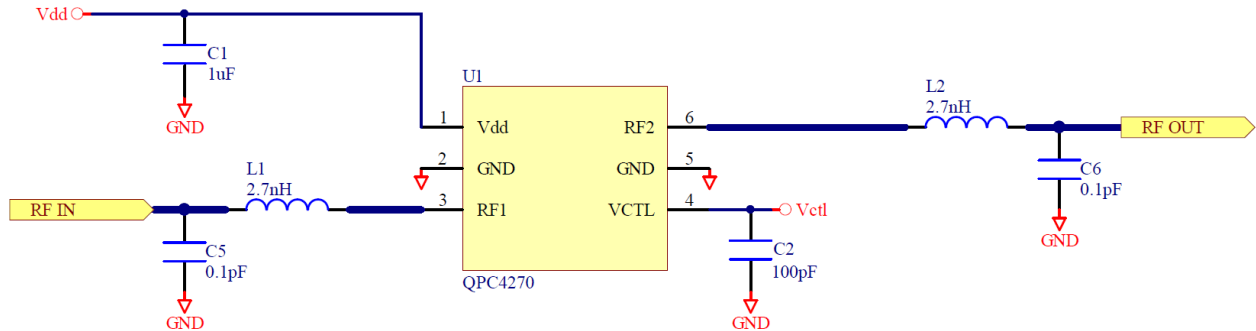

Notes:

1. L1/C5 and L2/C6 are optimized for return loss from 1MHz through 1.8GHz on the Qorvo QPC4270-4000(B) EVB.
2. For operation from 1MHz to 1.2GHz, C5 and C6 can be deleted. L1 and L2 can be typically reduced to 1.8 – 2.2nH.
3. C2 may be needed to reduce RF pickup from other circuits in a noisy or mixed signal environment.
4. C5 and C6 are sensitive to layout and placement – may not be necessary in the application.
5. Blocking caps are not required for the RF1 and RF2 pins unless there is DC present on the transmission paths.

Typical Application Schematic; 1MHz to 3.3GHz

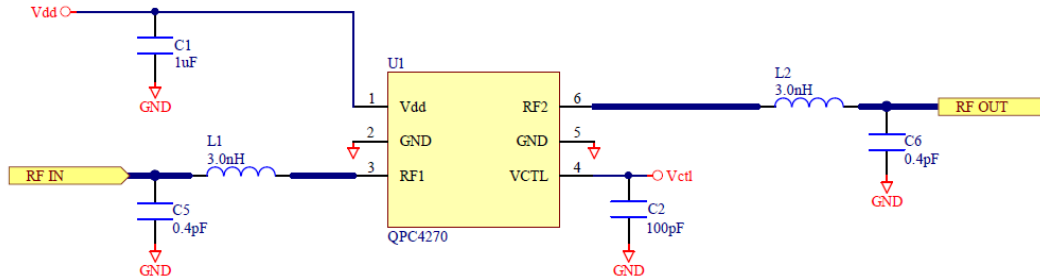

Notes:

1. For operation from 1MHz to 3.3GHz, the inductance at L1 and L2 is increased slightly from the 1MHz to 1.8GHz Application Circuit and the matching capacitance at C5 and C6 is also increased to introduce resonance at 2.5 to 3GHz.
2. Matching components should be as close to QPC4270 as possible and may require tuning in the application circuit to account for PCB and layout differences.

Performance Plots; 1MHz to 3.3GHz Application Data

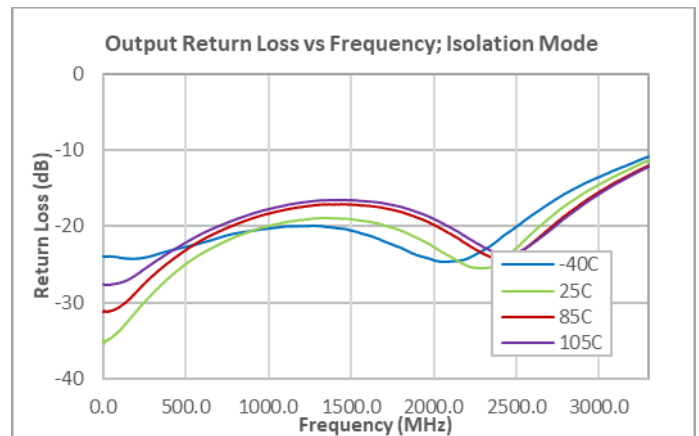
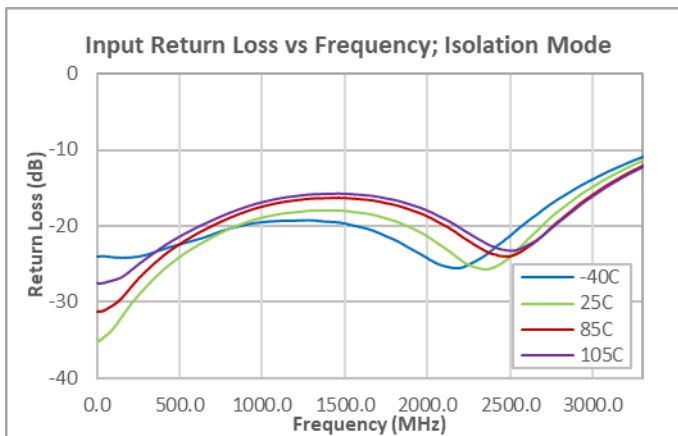
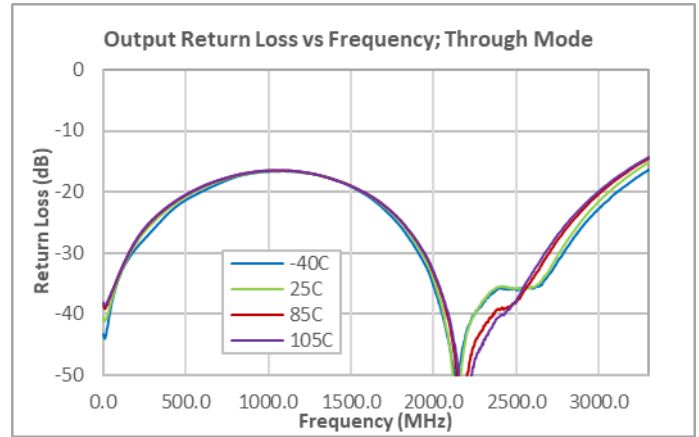
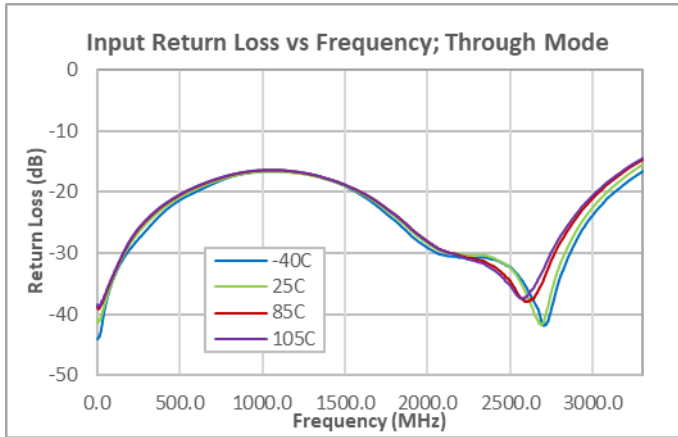
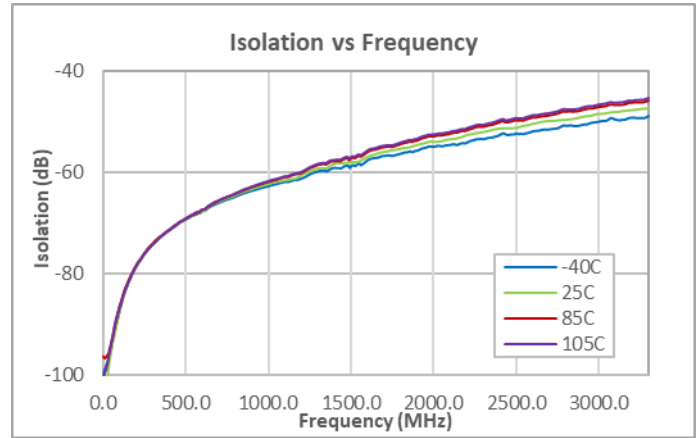
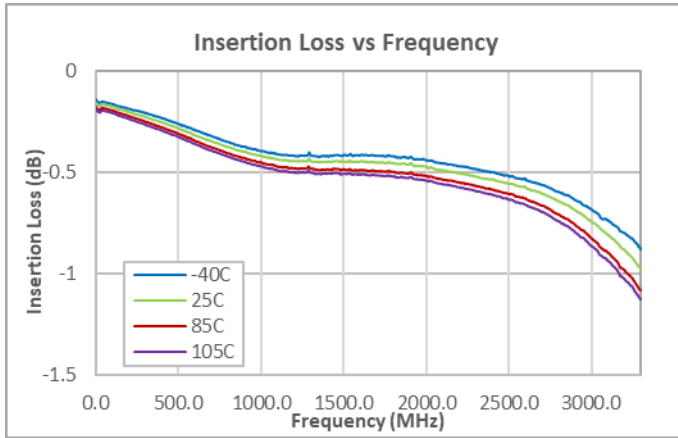

Test Conditions:

1. Test conditions unless otherwise noted: $V_{DD} = +3.0V$, $Z_0 = 75\Omega$ on QPC4270-4000(B) EVB modified for 1MHz to 3.3GHz Application Circuit (pg 9).
2. Insertion Loss deembedded for EVB loss.

Performance Plots; 1MHz to 3.3GHz Application Data (cont'd.)

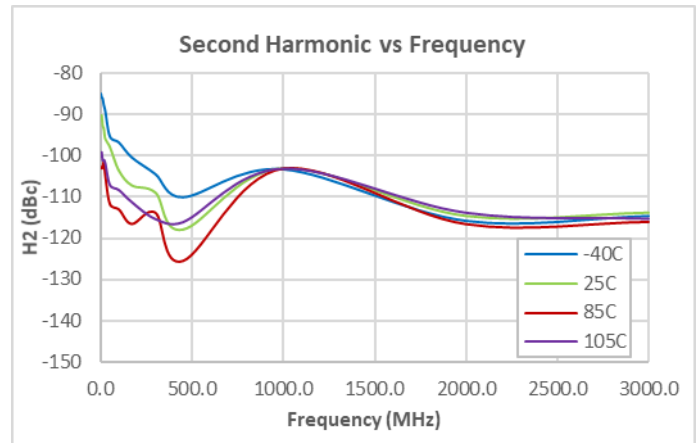
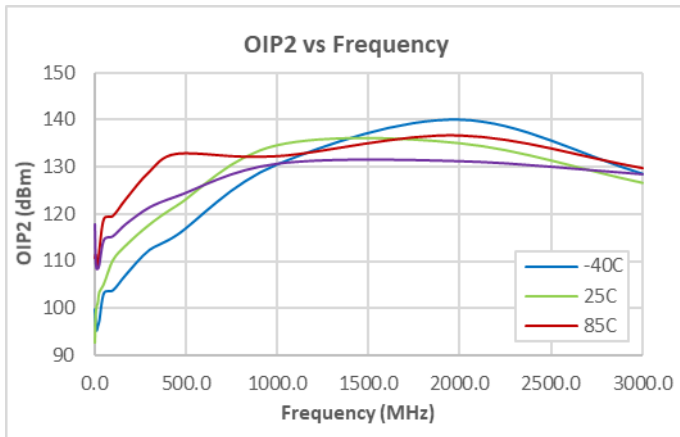
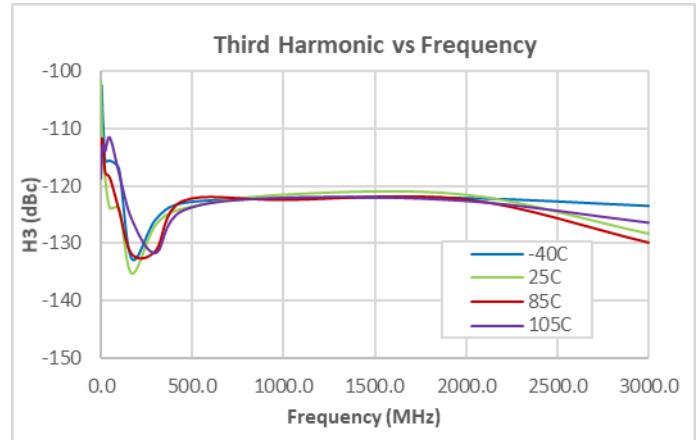
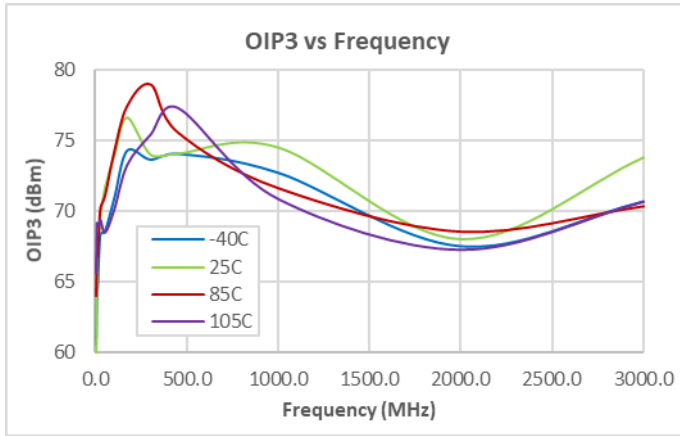

Test Conditions:

1. Test conditions unless otherwise noted: $V_{DD} = +3.0V$, $Z_o = 75\Omega$, QPC4270-4000(B) EVB modified for 1MHz to 3.3GHz Application Circuit (pg 9).
2. IIP3, IP2: 75 Ω , +12dBm per Tone.

Pin Configuration and Description

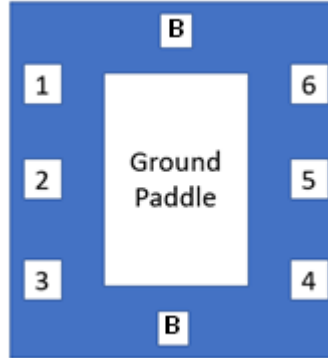

Pin Number	Label	Description
1	V _{DD}	Supply Connection
2	GND	Ground Connection
3	RF1	RF Port
4	CTRL	Switch Logic Control Input
6	RF2	RF Port
Ground Paddle	GND	Ground Connection
B	GND	Internally Grounded. Can be connected to ground or left open.

Notes:

1. Both RF pins must be held at 0V_{DC} or require external DC blocking capacitors.
2. The ground paddle must be soldered to the ground plane for proper switch performance.

Package Dimensions

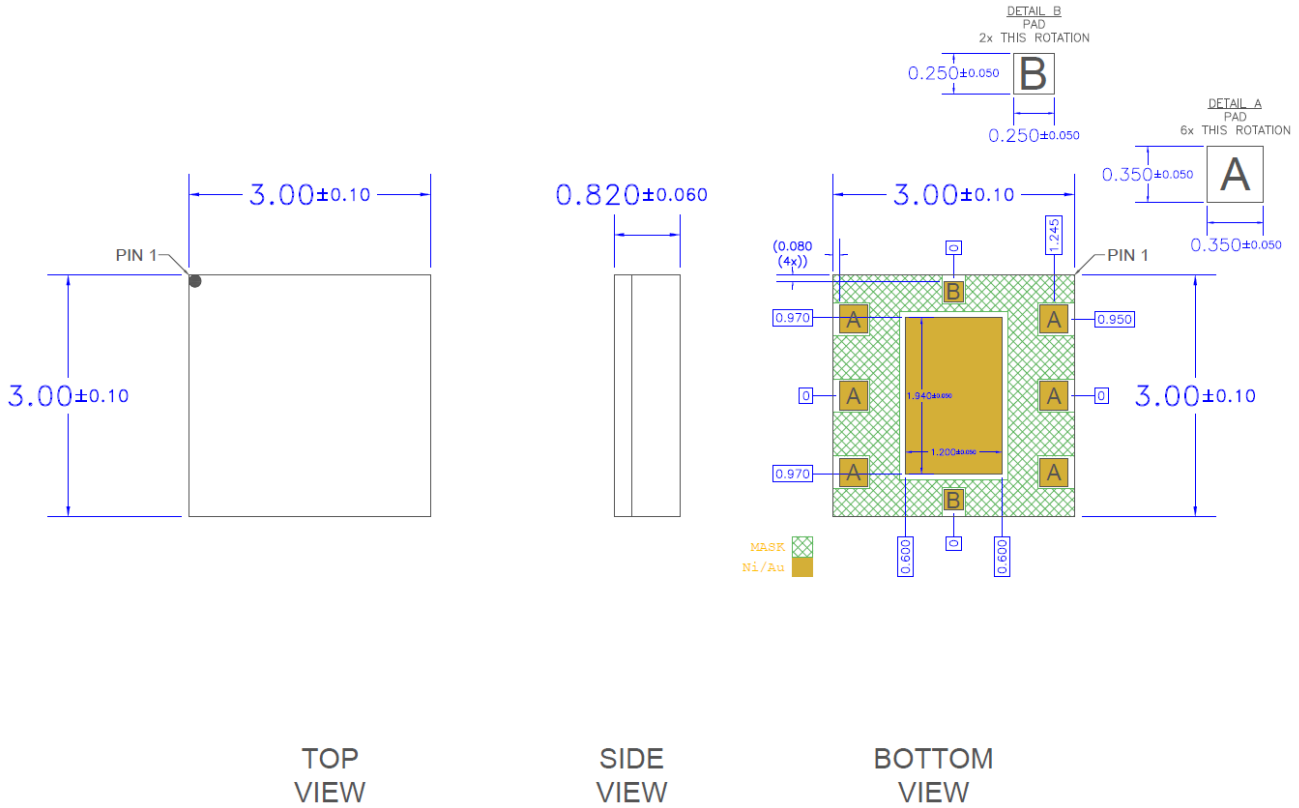

Notes:
 1. All dimensions are in millimeters. Angles are in degrees.

Package Marking

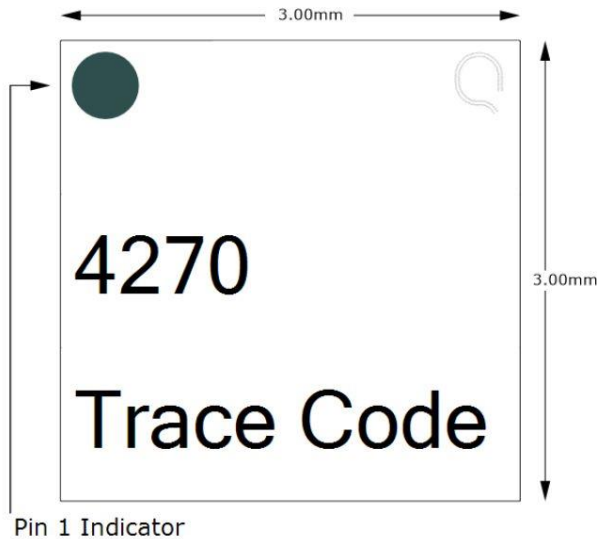

PCB Mounting Pattern

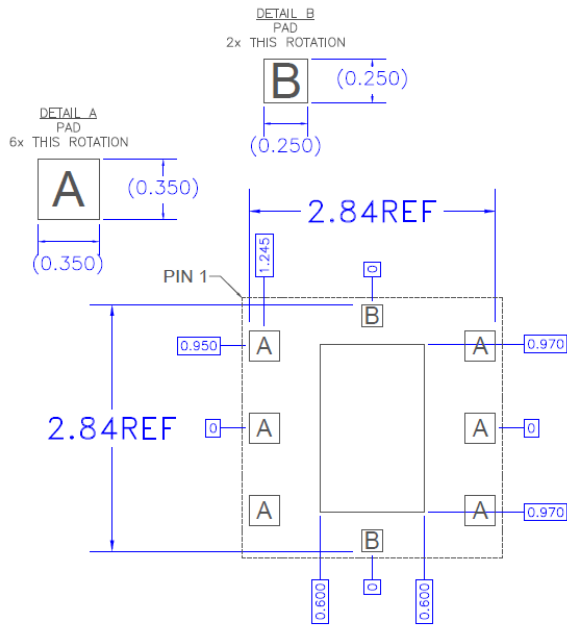

RECOMMENDED
LAND PATTERN

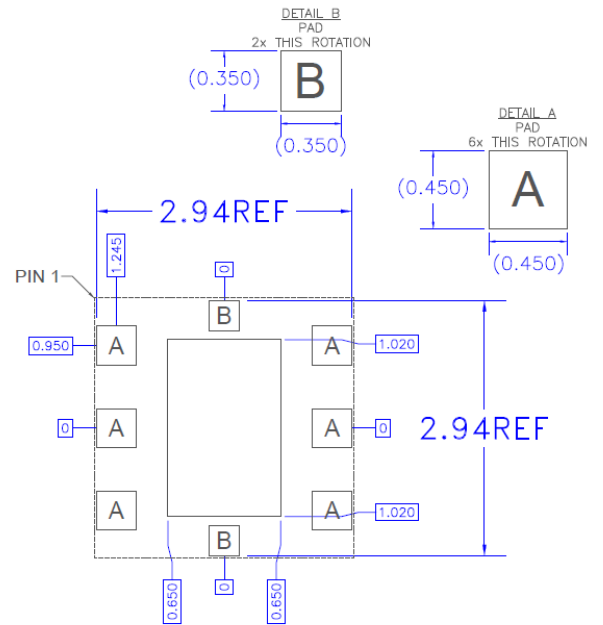

RECOMMENDED
LAND PATTERN MASK

Notes:

1. All dimensions are in millimeters. Angles are in degrees.

Handling Precautions

Parameter	Rating	Standard
ESD – Human Body Model (HBM)	1C (2000V)	ESDA / JEDEC JS-001-2012
ESD – Charged Device Model (CDM)	C3 (1000V)	JEDEC JESD22-C101F
MSL – Moisture Sensitivity Level	MSL3	IPC/JEDEC J-STD-020



Caution!
ESD-Sensitive Device

Solderability

Compatible with both lead-free (260°C max. reflow temp.) soldering process.
Solder profiles available upon request.

Contact plating: ENEPIG

RoHS Compliance

This part is compliant with EU 2011/65/EU RoHS directive (Restrictions on the Use of Certain Hazardous Substances in Electrical and Electronic Equipment), as amended by Directive 2015/863/EU. This product also has the following attributes:

- Lead Free
- Halogen Free (Chlorine, Bromine)
- Antimony Free
- TBBP-A (C₁₅H₁₂Br₄O₂) Free
- SVHC Free
- PFOS Free



Contact Information

For the latest specifications, additional product information, worldwide sales and distribution locations:

Tel: 1-844-890-8163

Web: www.qorvo.com

Email: customer.support@qorvo.com

Important Notice

The information contained in this Data Sheet and any associated documents (“Data Sheet Information”) is believed to be reliable; however, Qorvo makes no warranties regarding the Data Sheet Information and assumes no responsibility or liability whatsoever for the use of said information. All Data Sheet Information is subject to change without notice. Customers should obtain and verify the latest relevant Data Sheet Information before placing orders for Qorvo® products. Data Sheet Information or the use thereof does not grant, explicitly, implicitly or otherwise any rights or licenses to any third party with respect to patents or any other intellectual property whether with regard to such Data Sheet Information itself or anything described by such information.

DATA SHEET INFORMATION DOES NOT CONSTITUTE A WARRANTY WITH RESPECT TO THE PRODUCTS DESCRIBED HEREIN, AND QORVO HEREBY DISCLAIMS ANY AND ALL WARRANTIES WITH RESPECT TO SUCH PRODUCTS WHETHER EXPRESS OR IMPLIED BY LAW, COURSE OF DEALING, COURSE OF PERFORMANCE, USAGE OF TRADE OR OTHERWISE, INCLUDING THE IMPLIED WARRANTIES OF MERCHANTABILITY AND FITNESS FOR A PARTICULAR PURPOSE. Without limiting the generality of the foregoing, Qorvo® products are not warranted or authorized for use as critical components in medical, life-saving, or life-sustaining applications, or other applications where a failure would reasonably be expected to cause severe personal injury or death. Applications described in the Data Sheet Information are for illustrative purposes only. Customers are responsible for validating that a particular product described in the Data Sheet Information is suitable for use in a particular application.

© 2021 Qorvo US, Inc. All rights reserved. This document is subject to copyright laws in various jurisdictions worldwide and may not be reproduced or distributed, in whole or in part, without the express written consent of Qorvo US, Inc. | QORVO® is a registered trademark of Qorvo US, Inc.

X-ON Electronics

Largest Supplier of Electrical and Electronic Components

Click to view similar products for [RF Development Tools](#) category:

Click to view products by [Qorvo](#) manufacturer:

Other Similar products are found below :

[MAAM-011117](#) [MAAP-015036-DIEEV2](#) [EV1HMC1113LP5](#) [EV1HMC6146BLC5A](#) [EV1HMC637ALP5](#) [EVAL-ADG919EBZ](#) [ADL5363-EVALZ](#) [LMV228SDEVAL](#) [SKYA21001-EVB](#) [SMP1331-085-EVB](#) [EV1HMC618ALP3](#) [EVAL01-HMC1041LC4](#) [MAAL-011111-000SMB](#)
[MAAM-009633-001SMB](#) [107712-HMC369LP3](#) [107780-HMC322ALP4](#) [SP000416870](#) [EV1HMC470ALP3](#) [EV1HMC520ALC4](#)
[EV1HMC244AG16](#) [MAX2614EVKIT#](#) [124694-HMC742ALP5](#) [SC20ASATEA-8GB-STD](#) [MAX2837EVKIT+](#) [MAX2612EVKIT#](#)
[MAX2692EVKIT#](#) [EV1HMC629ALP4E](#) [SKY12343-364LF-EVB](#) [108703-HMC452QS16G](#) [EV1HMC863ALC4](#) [EV1HMC427ALP3E](#)
[119197-HMC658LP2](#) [EV1HMC647ALP6](#) [ADL5725-EVALZ](#) [106815-HMC441LM1](#) [EV1HMC1018ALP4](#) [UXN14M9PE](#) [MAX2016EVKIT](#)
[EV1HMC939ALP4](#) [MAX2410EVKIT](#) [MAX2204EVKIT+](#) [EV1HMC8073LP3D](#) [SIMSA868-DKL](#) [SIMSA868C-DKL](#) [SKY65806-636EK1](#)
[SKY68020-11EK1](#) [SKY67159-396EK1](#) [SKY66181-11-EK1](#) [SKY65804-696EK1](#) [SKY13396-397LF-EVB](#)