

Product Overview

The QPC6082 is a low loss, high isolation SP8T switch with performance optimized for CDMA, WCDMA & LTE applications requiring high linearity

The RF and antenna ports can be directly connected in 50 Ω systems and control logic is compatible with +1.3 V to +1.8V systems. DC blocking caps are not required if there is no external DC voltage present at the RF or antenna ports. The supply voltage is intended for connection to +2.85 V systems but the device is operable from +2.4 V to +4.5 V.

The standard 14 pad QFN package and compact 2.0 mm x 2.0 mm size offers designers a compact, easy-to-use, switch component for quick integration into multimode, multi-band systems.

Functional Block Diagram

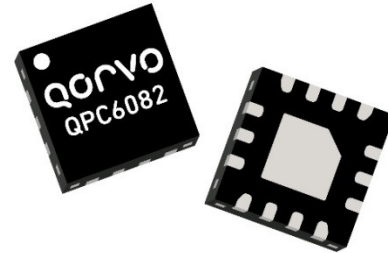
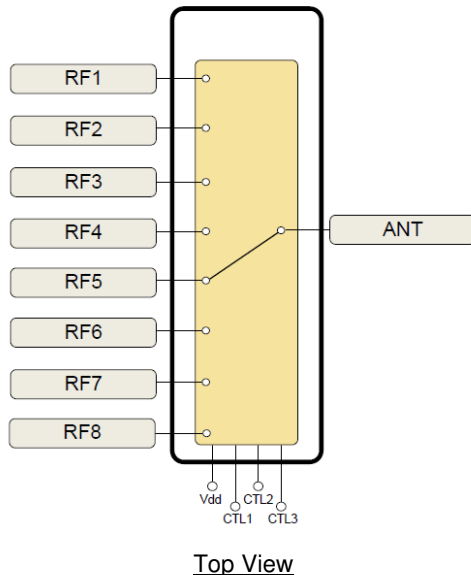

14 Pad 2.0 mm x 2.0 mm x 0.55 mm QFN Package

Key Features

- Very Low Insertion Loss: 0.4 dB typ. In Band 5
- High Port-to-Port Isolation: 31 dB typ. In Band 5
- Power Handling up to +32 dBm into 50 Ω
- GPIO Interface for +1.3 V to +1.8 V Control Logic
- Multi-Band Operation 700 MHz to 2700 MHz
- Compact 2.0 mm x 2.0 mm QFN Package
- No DC Blocking Capacitors Required (unless external DC is applied to the RF ports)

Applications

- Data Cards
- IoT
- Telemetry
- Automotive
- Cellular Modems and USB Devices
- Multi-Mode WCDMA, LTE Applications

Ordering Information

Part No.	Description
QPC6082	SP8T Switch for 3G/4G
QPC6082SB	Sample Bag with 5 pieces
QPC6082SQ	Sample Bag with 25 pieces
QPC6082SR	Sample Reel with 100 pieces
QPC6082TR7	2500-PC Taped on 13" Reel Fully
QPC6082PCK401	Assembled EVB + 5 Piece Sample Bag

Absolute Maximum Ratings

Parameter		Rating
Storage Temperature		-40 to +125 °C
Operating Temperature		-30 to +90 °C
Maximum V _{DD}		+6.0 V
Maximum V _{CTRL}		+3.0 V
Max Input Power (Momentary Infrequent Occurrence)	1:1 VSWR, +25°C	+38.5 dBm
	6:1 VSWR, +25°C	+35.0 dBm
Max Input Power (Continuous Operation)	1:1 VSWR, +25°C	+36.5 dBm
	6:1 VSWR, +25°C	+35.5 dBm

Exceeding any one or a combination of the Absolute Maximum Rating conditions may cause permanent damage to the device. Extended application of Absolute Maximum Rating conditions to the device may reduce device reliability.

Recommended Operating Conditions

Parameter	Min	Typ	Max	Units
Device Voltage (V _{DD})	+2.4	+2.85	+4.5	V
V _{DD} Supply Current	-	80	120	µA
C _{TL1,2,3} Logic Low Voltage	0.00	-	+0.45	V
C _{TL1,2,3} Logic High Voltage ⁽¹⁾	+1.3	-	+2.7	V
C _{TL1,2,3} Logic High Current	-		5	µA
Switching Time ⁽²⁾			2	µs
Turn-On Time ⁽³⁾		4		µs

Electrical specifications are measured at specified test conditions. Specifications are not guaranteed over all recommended operating conditions.

Notes:

- V_{DD} must be > V_{CTRL} at all times.
- 10% to 90% RF.
3. Time from VDD=0V to part ON and RF at 90%.

Electrical Specifications

Parameter		Conditions ⁽¹⁾	Min	Typ	Max	Units	
Insertion Loss RFX to ANT		704 – 787 MHz	-	0.40	0.55	dB	
		815 – 960 MHz	-	0.40	0.55		
		1710 – 1980 MHz	-	0.50	0.70		
		2110 – 2170 MHz	-	0.66	0.79		
		2300 – 2690 MHz	-	0.76	0.90		
Harmonics	Low Band, 2fo	Pin = +28 dBm, 50 Ω	fo=824 MHz	-	-115	-96	dBc
	Low Band, 3fo		fo=824 MHz	-	-84	-81	
	High Band, 2fo		fo=1980 MHz	-	-99	-86	
	High Band, 3fo		fo=1980 MHz	-	-82	-76	
	High Band, 2fo		fo=2570 MHz	-	-92	-88	
	High Band, 3fo		fo=2570 MHz	-	-79	-75	
Input IP2	Low Band	TX Carrier at 897.5 MHz at +21 dBm CW Blocker at 1840 MHz at -15 dBm Measured RX frequency = 942.5 MHz	113	117	-	dB	
	High Band	TX Carrier at 1880 MHz at +21 dBm CW Blocker at 3840 MHz at -15 dBm Measured RX frequency = -1960 MHz	115	118	-	dB	
Input IP3	Low Band	TX Carrier at 897.5 MHz at +21 dBm CW Blocker at 1840 MHz at -15 dBm Measured RX frequency = 942.5 MHz	66	68	-	dB	
	High Band	TX Carrier at 1880 MHz at +21 dBm CW Blocker at 3840 MHz at -15 dBm Measured RX frequency = 1960 MHz	67	69	-	dB	
Triple Beat Ratio		VSWR=2:1, BC0/BC1/BC4/BC5/BC14/BC15	81	-	-	dBc	
VSWR		704 – 2690 MHz	-	1.1:1	1.5:1	-	

Notes:

- Test conditions unless otherwise stated: all unused RF ports terminated in 50 Ω, Input and Output = 50 Ω, Temp. = +25 °C, V_{DD} = +2.85V, V_{CTRL} High = +1.8V, V_{CTRL} Low = 0 V

Electrical Specifications ⁽¹⁾ – Isolation Matrix – 704 MHz to 960 MHz

Values Min/Typ (dB)	RF1	RF2	RF3	RF4	RF5	RF6	RF7	RF8	ANT ⁽²⁾
RF1	-	35 / 43	36 / 44	36 / 48	39 / 42	38 / 46	37 / 44	37 / 43	31 / 34
RF2	-	-	30 / 33	38 / 43	37 / 46	43 / 46	41 / 46	40 / 46	31 / 44
RF3	-	-	-	30 / 32	36 / 40	41 / 47	41 / 43	40 / 43	31 / 43
RF4	-	-	-	-	36 / 43	40 / 47	39 / 43	39 / 41	30 / 42
RF5	-	-	-	-	-	34 / 43	36 / 48	36 / 45	30 / 33
RF6	-	-	-	-	-	-	31 / 33	38 / 40	35 / 44
RF7	-	-	-	-	-	-	-	29 / 31	33 / 41
RF8	-	-	-	-	-	-	-	-	33 / 42

- Notes:
1. Test conditions unless otherwise stated: all unused RF ports terminated in 50 Ω, Input and Output = 50 Ω, Temp. = +25 °C, V_{DD} = +2.85V, V_{CTRL} High = +1.8V, V_{CTRL} Low = 0V.
 2. RFx path not selected.

Electrical Specifications ⁽¹⁾ – Isolation Matrix – 1710 MHz to 2170 MHz

Values Min/Typ (dB)	RF1	RF2	RF3	RF4	RF5	RF6	RF7	RF8	ANT ⁽²⁾
RF1	-	27 / 31	29 / 31	29 / 35	28 / 30	29 / 32	29 / 31	29 / 31	21 / 25
RF2	-	-	21 / 23	27 / 30	29 / 30	30 / 33	29 / 33	28 / 31	26 / 32
RF3	-	-	-	21 / 23	29 / 31	29 / 33	29 / 31	28 / 31	26 / 32
RF4	-	-	-	-	29 / 31	28 / 33	26 / 31	27 / 29	26 / 31
RF5	-	-	-	-	-	27 / 31	29 / 34	29 / 35	21 / 25
RF6	-	-	-	-	-	-	22 / 24	27 / 31	27 / 31
RF7	-	-	-	-	-	-	-	20 / 22	26 / 32
RF8	-	-	-	-	-	-	-	-	25 / 31

- Notes:
1. Test conditions unless otherwise stated: all unused RF ports terminated in 50 Ω, Input and Output = 50 Ω, Temp. = +25 °C, V_{DD} = +2.85V, V_{CTRL} High = +1.8V, V_{CTRL} Low = 0V.
 2. RFx path not selected.

Electrical Specifications ⁽¹⁾ – Isolation Matrix – 2300 MHz to 2690 MHz

Values Min/Typ (dB)	RF1	RF2	RF3	RF4	RF5	RF6	RF7	RF8	ANT ⁽²⁾
RF1	-	25 / 27	27 / 30	27 / 31	25 / 27	27 / 29	26 / 28	26 / 28	18 / 20
RF2	-	-	18 / 20	24 / 27	26 / 29	28 / 29	26 / 29	25 / 28	24 / 29
RF3	-	-	-	18 / 20	26 / 28	29 / 29	26 / 25	25 / 27	24 / 28
RF4	-	-	-	-	26 / 28	25 / 29	25 / 27	25 / 27	24 / 28
RF5	-	-	-	-	-	25 / 27	27 / 30	27 / 30	19 / 21
RF6	-	-	-	-	-	-	20 / 21	24 / 27	24 / 29
RF7	-	-	-	-	-	-	-	18 / 19	24 / 28
RF8	-	-	-	-	-	-	-	-	23 / 28

- Notes:
1. Test conditions unless otherwise stated: all unused RF ports terminated in 50 Ω, Input and Output = 50 Ω, Temp. = +25 °C, V_{DD} = +2.85V, V_{CTRL} High = +1.8V, V_{CTRL} Low = 0V.
 2. RFx path not selected.

Control Logic

Mode (Signal Path)	CTL1	CTL2	CTL3
RF1 – ANT	High	Low	Low
RF2 – ANT	Low	High	Low
RF3 – ANT	High	High	Low
RF4 – ANT	Low	Low	High
RF5 – ANT	High	Low	High
RF6 – ANT	Low	High	High
RF7 – ANT	High	High	High
RF8 – ANT	Low	Low	Low

NOTE: The SP8T switch is controlled by CTL1, CTL2, and CTL3.

Recommended Operating Power, 50 Ω System

Frequency	Power at T=+85 °C	Power at T=+105 °C	Theta-J(°C/W)
8 MHz	+30 dBm	+30 dBm	236
20 MHz to 100MHz	+34.5dBm	+31.5 dBm	110
500MHz – 3GHz	+36dBm	+32dBm	55
4GHz	+35dBm	+31dBm	57

Performance Plots

Test conditions unless otherwise noted: $V_{DD} = +2.85\text{ V}$

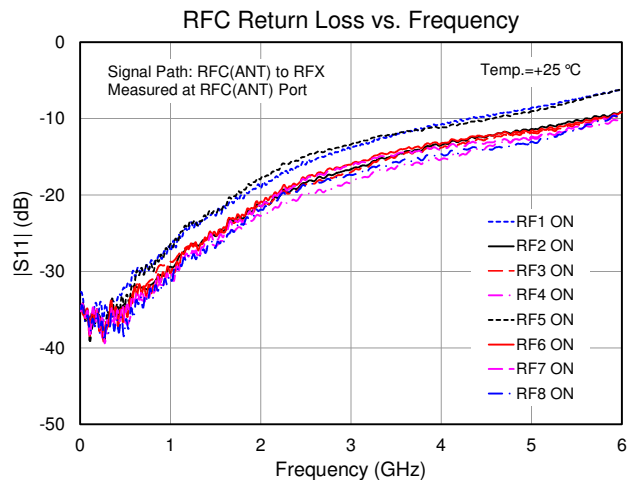
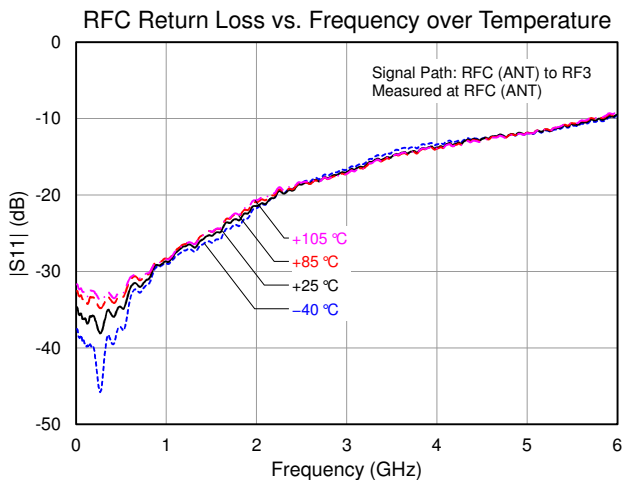
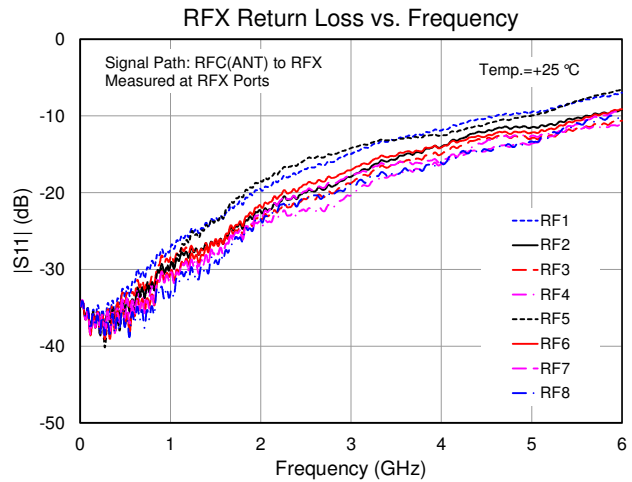
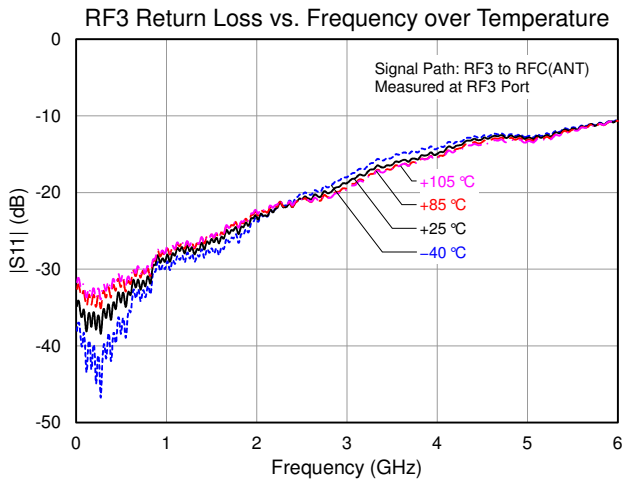
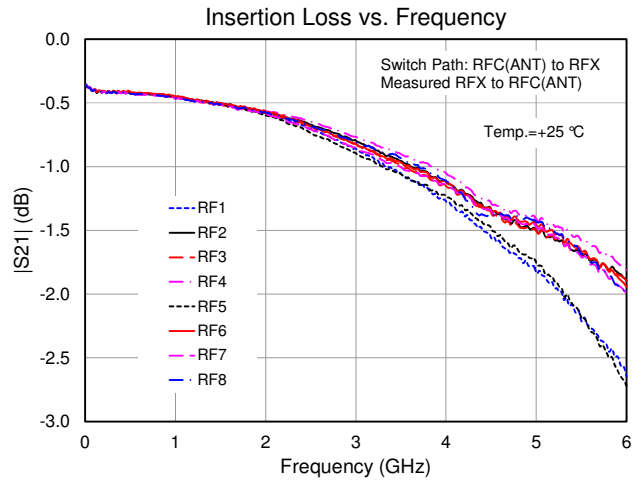
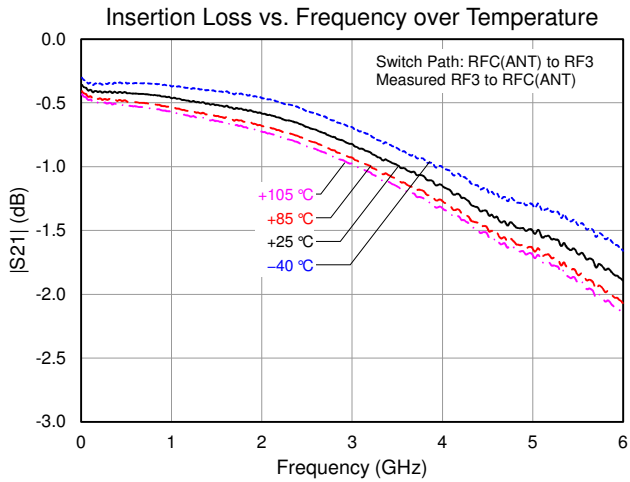

Performance Plots

Test conditions unless otherwise noted: $V_{DD} = +2.85\text{ V}$

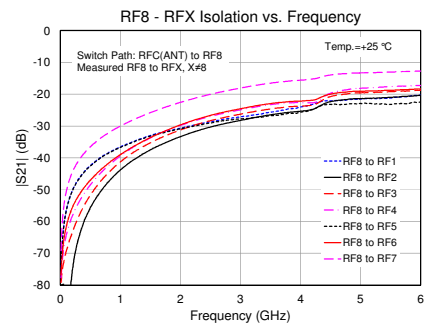
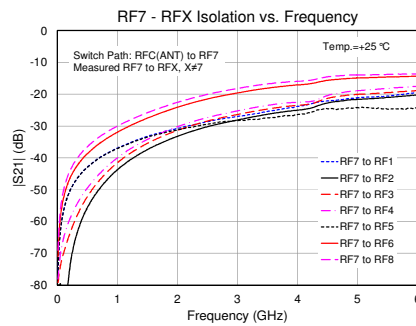
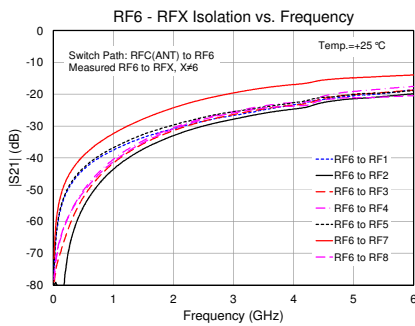
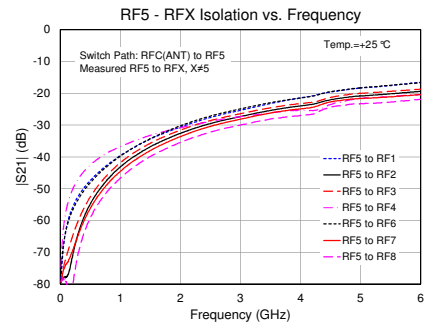
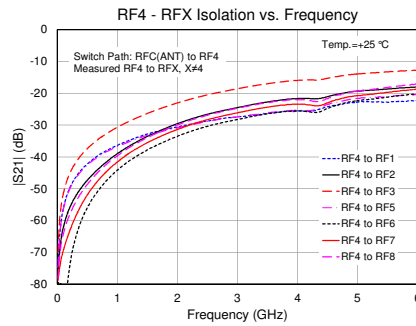
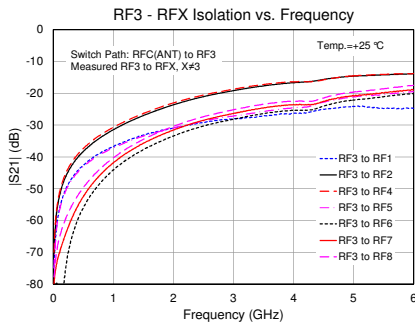
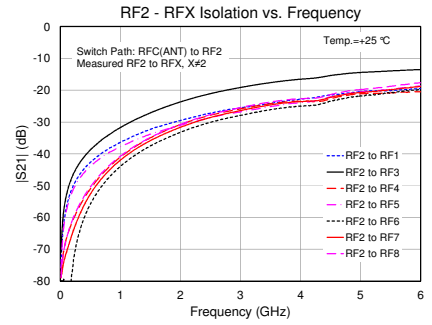
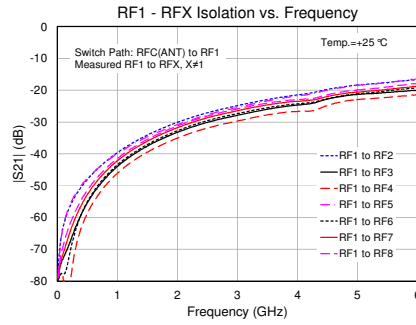
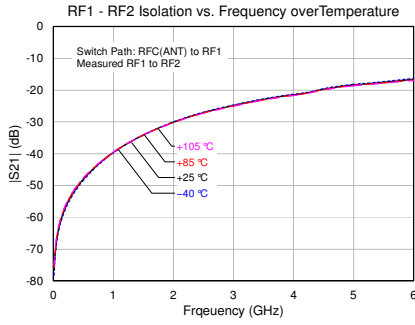

Performance Plots

Test conditions unless otherwise noted: $V_{DD} = +2.85\text{ V}$

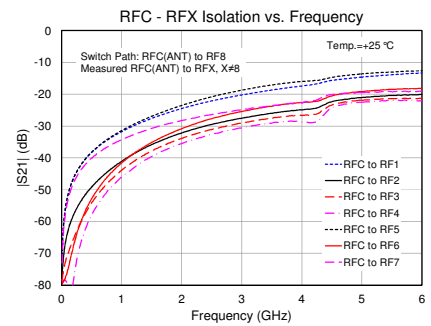
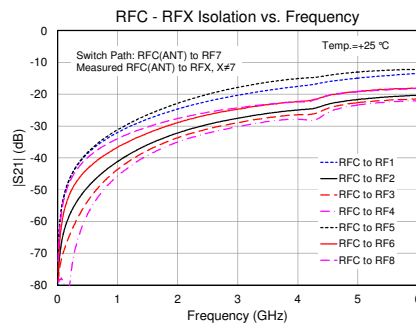
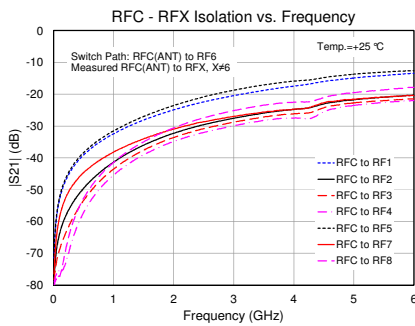
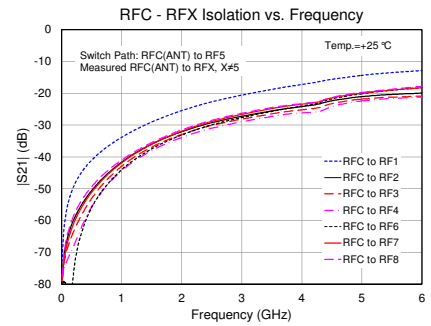
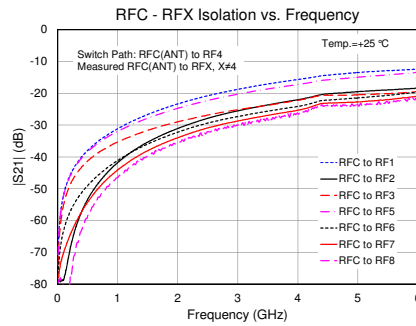
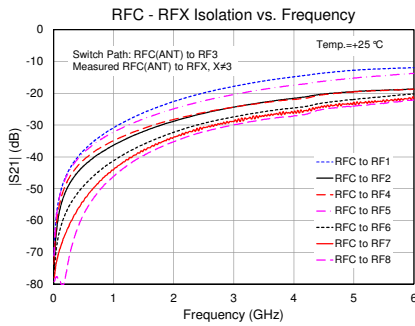
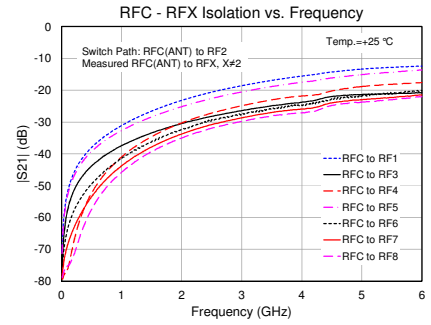
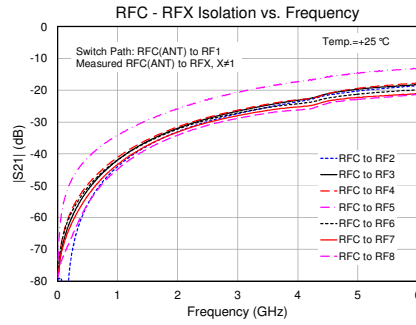
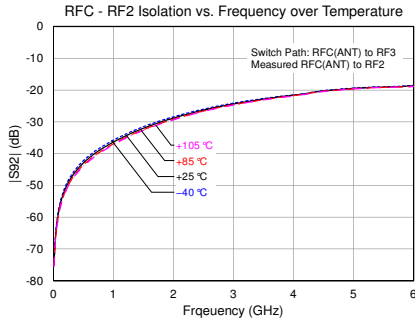

Evaluation Board Schematic

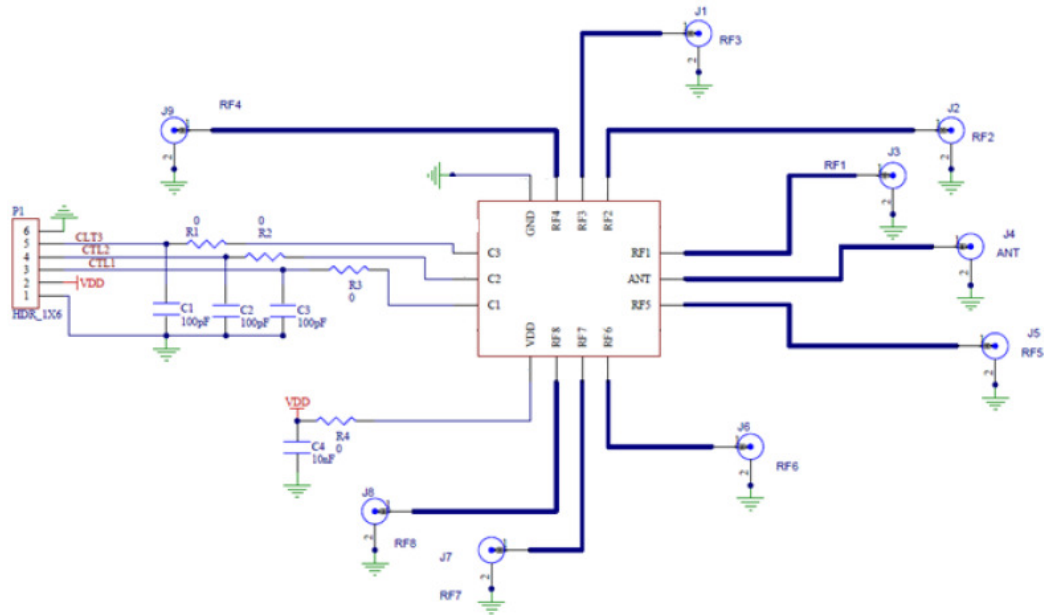

Applications Notes

Unused RF ports of the QPC6082 should be grounded

Power-Up/Down Sequence

It is very important that the user adhere to the correct power-up/down sequence in order to avoid damaging the device. If VDD is not supplied at any time the control lines must all be set to 0V (or ground).

ON Sequence: First turn ON VDD, then to apply control signals.

OFF Sequence: First turn OFF the control signals, then to turn OFF VDD.

Pin Configuration and Description

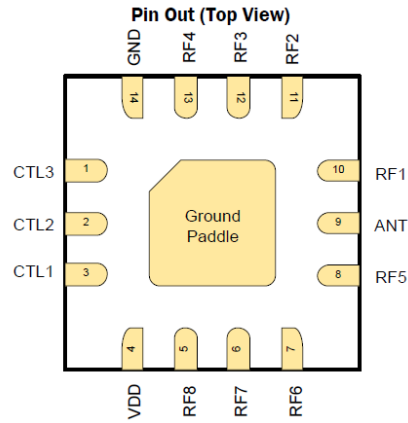

Pad No.	Label	Description
1	CTL3	Control Logic #3.
2	CTL2	Control Logic #2.
3	CTL1	Control Logic #1.
4	V _{DD}	Power Supply.
5	RF8	RF output.
6	RF7	RF output.
7	RF6	RF output.
8	RF5	RF output.
9	ANT	RF signal in Antenna.
10	RF1	RF output.
11	RF2	RF output.
12	RF3	RF output.
13	RF4	RF output.
14, Backside Pad	GND	RF and DC Ground.

Package Marking and Dimensions

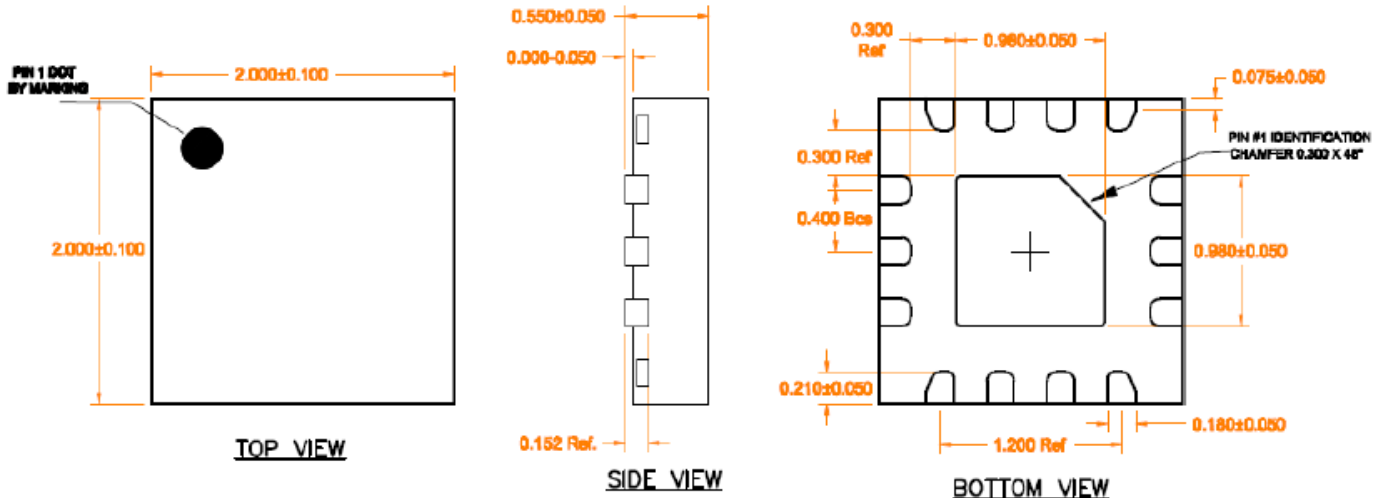

PCB Mounting Patterns

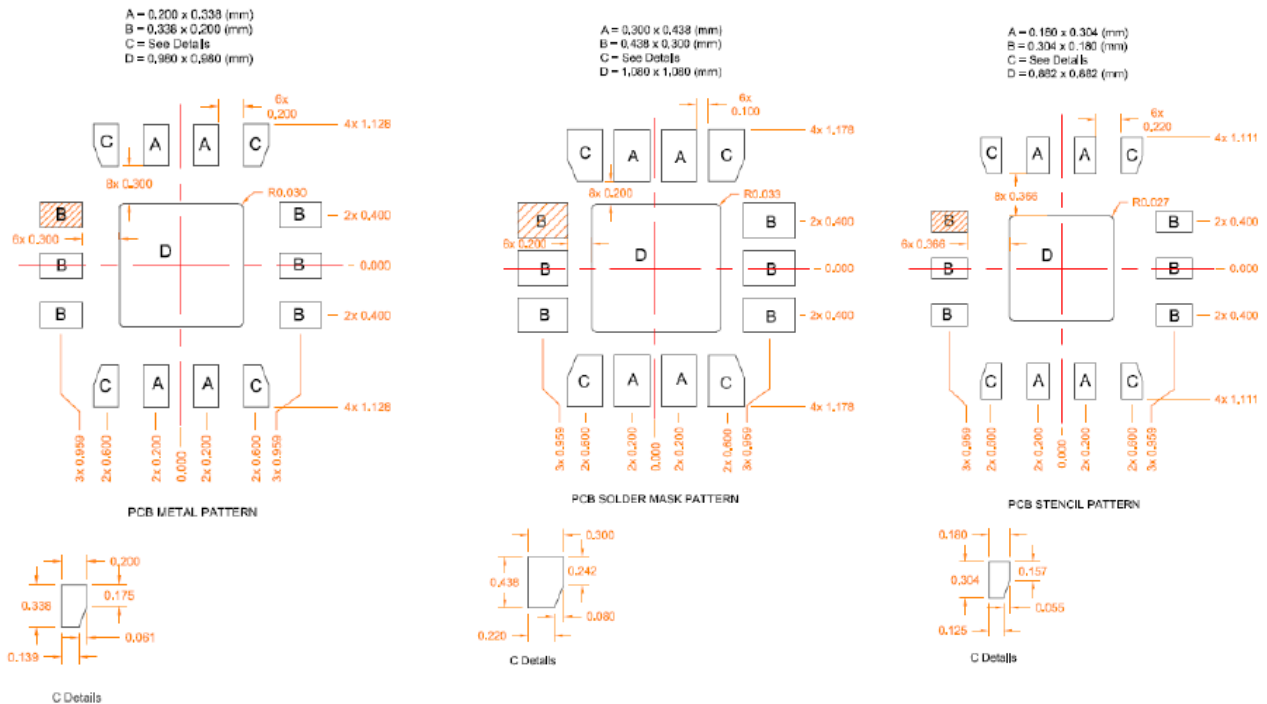

Notes:

1. Thermal vias for center slug "E" should be incorporated into the PCB design. The number and size of thermal vias will depend on the application, the power dissipation and the electrical requirements. An example of the number and size of the vias can be found on the Qorvo evaluation board layout.
2. Shaded pad in drawing above indicates pin 1 location.

Handling Precautions

Parameter	Rating	Standard
ESD – Human Body Model (HBM)	Class 1C	ESDA / JEDEC JS-001-2012
ESD – Charged Device Model (CDM)	Class C2b	JEDEC JESD22-C101F
MSL – Moisture Sensitivity Level	MSL 2	IPC/JEDEC J-STD-020



Caution!
ESD-Sensitive Device

Solderability

Compatible with both lead-free (260°C max. reflow temp.) and tin/lead (245°C max. reflow temp.) soldering processes. Solder profiles available upon request.

Contact plating: NiPdAu

RoHS Compliance

This part is compliant with 2011/65/EU RoHS directive (Restrictions on the Use of Certain Hazardous Substances in Electrical and Electronic Equipment) as amended by Directive 2015/863/EU.

This product also has the following attributes:

- Lead Free
- Halogen Free (Chlorine, Bromine)
- Antimony Free
- TBBP-A (C₁₅H₁₂Br₄O₂) Free
- PFOS Free
- SVHC Free



Contact Information

For the latest specifications, additional product information, worldwide sales and distribution locations:

Web: www.qorvo.com

Tel: 1-844-890-8163

Email: customer.support@qorvo.com

Important Notice

The information contained herein is believed to be reliable; however, Qorvo makes no warranties regarding the information contained herein and assumes no responsibility or liability whatsoever for the use of the information contained herein. All information contained herein is subject to change without notice. Customers should obtain and verify the latest relevant information before placing orders for Qorvo products. The information contained herein or any use of such information does not grant, explicitly or implicitly, to any party any patent rights, licenses, or any other intellectual property rights, whether with regard to such information itself or anything described by such information. **THIS INFORMATION DOES NOT CONSTITUTE A WARRANTY WITH RESPECT TO THE PRODUCTS DESCRIBED HEREIN, AND QORVO HEREBY DISCLAIMS ANY AND ALL WARRANTIES WITH RESPECT TO SUCH PRODUCTS WHETHER EXPRESS OR IMPLIED BY LAW, COURSE OF DEALING, COURSE OF PERFORMANCE, USAGE OF TRADE OR OTHERWISE, INCLUDING THE IMPLIED WARRANTIES OF MERCHANTABILITY AND FITNESS FOR A PARTICULAR PURPOSE.**

Without limiting the generality of the foregoing, Qorvo products are not warranted or authorized for use as critical components in medical, life-saving, or life-sustaining applications, or other applications where a failure would reasonably be expected to cause severe personal injury or death.

Copyright 2016 © Qorvo, Inc. | Qorvo is a registered trademark of Qorvo, Inc.

X-ON Electronics

Largest Supplier of Electrical and Electronic Components

Click to view similar products for [RF Switch ICs](#) category:

Click to view products by [Qorvo](#) manufacturer:

Other Similar products are found below :

[MASW-008853-TR3000](#) [BGS13SN8E6327XTSA1](#) [BGSX210MA18E6327XTSA1](#) [SKY13446-374LF](#) [SW-227-PIN](#) [CG2185X2](#) [CG2415M6](#)
[MA4SW410B-1](#) [MASW-002102-13580G](#) [MASW-008543-001SMB](#) [MASW-008955-TR3000](#) [TGS4307](#) [BGS 12PL6 E6327](#)
[BGS1414MN20E6327XTSA1](#) [BGS1515MN20E6327XTSA1](#) [BGSA11GN10E6327XTSA1](#) [BGSX28MA18E6327XTSA1](#) [HMC199AMS8](#)
[HMC986A](#) [SKY13374-397LF](#) [SKY13453-385LF](#) [CG2430X1-C2](#) [CG2415M6-C2](#) [HMC986A-SX](#) [SW-314-PIN](#) [UPG2162T5N-E2-A](#)
[SKY13416-485LF](#) [MASWSS0204TR-3000](#) [MASWSS0201TR](#) [MASWSS0181TR-3000](#) [MASW-007588-TR3000](#) [MASW-004103-13655P](#)
[MASW-003102-13590G](#) [MASWSS0202TR-3000](#) [MA4SW310B-1](#) [MA4SW110](#) [SW-313-PIN](#) [CG2430X1](#) [SKY13321-360LF](#) [SKY13405-](#)
[490LF](#) [BGSF 18DM20 E6327](#) [SKY13415-485LF](#) [MMS008PP3](#) [BGS13PN10E6327XTSA1](#) [SKY13319-374LF](#) [BGS14PN10E6327XTSA1](#)
[SKY12213-478LF](#) [SKY13404-466LF](#) [MASW-011060-TR0500](#) [SKYA21024](#)