

General Description

The QPC7522 is a high isolation Silicon on Insulator (SOI) single pole double throw (SPDT) reflective switch designed for use in CATV, satellite set top and other high-performance communications systems.

Featuring a single supply with a single CMOS/TTL compatible control line, QPC7522 features low insertion loss and high isolation throughout its bandwidth making it an optimal choice for operation from 5MHz to 3.3GHz. QPC7522 offers excellent linearity and power handling capability thanks to its SOI process and does not require blocking caps on the RF ports if DC is not present on the RF ports. QPC7522 is packaged in a very compact 1.1mm x 1.5mm 9-pin LGA package.

Functional Block Diagram

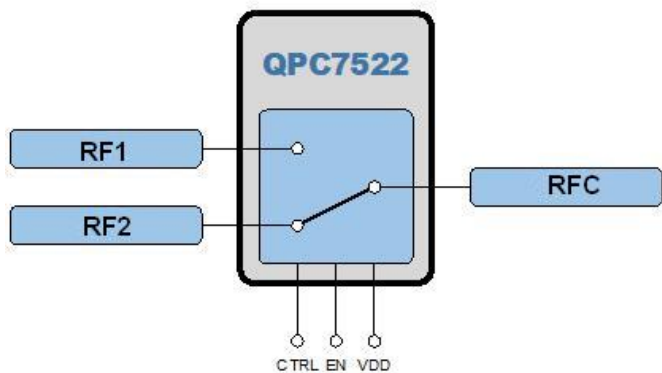

9 Pin 1.1 x 1.5 mm LGA Package

Product Features

- 5MHz to 3300MHz Operation
- Optimized for 75Ω Applications (can be also be used in 50Ω applications).
- Low Insertion Loss: 0.28dB at 1GHz
- High Isolation: 44dB at 1GHz
- High IP3: 75dBm at 1GHz
- Compatible with Low Voltage Logic (V_{HIGH} Minimum = 1.3V)
- No External DC Blocking Capacitors Required on RF Paths Unless DC is Applied Externally
- 2000V HBM ESD Rating on All Ports

Applications

- Extended Spectrum DOCSIS
- CATV Amplifiers
- CATV Head End
- Fiber Deep Nodes
- Cable Set Top Box
- Satellite Set Top Box

Ordering Information

Part Number	Description
QPC7522SB	Sample Bag with 5 pieces
QPC7522SR	Short Reel with 100 pieces
QPC7522TR7	Standard Reel with 2,500 pieces
QPC7522EVB-01	75 Ω PCBA



QPC7522

CATV SPDT Reflective Switch (5 – 3300 MHz)

Absolute Maximum Ratings

Parameter	Rating
Storage Temperature	-40 to +150°C
Operating Temperature	-40 to +105°C
Maximum V _{DD}	6.0V
Maximum V _{EN} , V _{CTRL}	3.0V
PIN Max (CW)	+32dBm(5MHz) +36dBm (>20MHz)

Exceeding any one or a combination of the Absolute Maximum Rating conditions may cause permanent damage to the device. Extended application of Absolute Maximum Rating conditions to the device may reduce device reliability.

Recommended Operating Conditions

Parameter	Min	Typ	Max	Units
Device Voltage (V _{DD})	+2.4	+5.0	+5.8	V
V _{EN} , V _{CTRL} High	1.3	1.8	2.75	V
V _{EN} , V _{CTRL} Low	0		0.45	V

Electrical specifications are measured at specified test conditions. Specifications are not guaranteed over all recommended operating conditions.

Electrical Specifications

Parameter	Conditions ⁽¹⁾	Min	Typ	Max	Units
Operational Frequency Range ⁽¹⁾		5		3300	MHz
Insertion Loss	5 – 50MHz		0.15		dB
	50-1000MHz		0.22		dB
	1000-2000MHz		0.28		dB
	2000-3000MHz		0.30		dB
	3300MHz		0.31		dB
Isolation, RFC - RFx	5 – 50MHz		78		dB
	50-1000MHz		44		dB
	1000-2000MHz		35		dB
	2000-3000MHz		31		dB
	3300MHz		30		dB
Isolation, RF1 – RF2	5 – 50MHz		76		dB
	50-1000MHz		46		dB
	1000-2000MHz		41		dB
	2000-3000MHz		33		dB
	3300MHz		32		dB
Input Return Loss; RFC	5 – 50MHz		40		dB
	50-1000MHz		23		dB
	1000-2000MHz		22		dB
	2000-3000MHz		25		dB
	3300MHz		29		dB
Output Return Loss; RFx	5 – 50MHz		40		dB
	50-1000MHz		25		dB
	1000-2000MHz		22		dB
	2000-3000MHz		24		dB
	3300MHz		30		dB

Notes:

1. Test conditions unless otherwise noted: V_{DD} = +3.3V, Temp = +25°C, 75Ω test system.



QPC7522

CATV SPDT Reflective Switch (5 – 3300 MHz)

Electrical Specifications (cont'd.)

Parameter	Conditions ⁽¹⁾	Min	Typ	Max	Units
P0.1 dB Compression ^(2, 3)	5MHz		38		dBm
	10MHz – 25MHz		41		
	25MHz – 3300MHz		42		
2 nd Harmonic	17MHz, 12dBm tone		-120		dBc
3 rd Harmonic	17MHz, 12dBm tone		-143		dBc
Output IP2	1000MHz, 12dBm per tone		124		dBm
Output IP3	1000MHz, 12dBm per tone		75		dBm
Supply Current I _{DD}	EN = High		52	100	μA
	EN = Low		2	5	μA
Control Current (EN, CTRL)	I _{HIGH}		2.5	5	μA
	I _{LOW}		0.1	3	μA
Switching Time	50% Control to 10% / 90% RF		2.6		μS
Thermal Resistance (θ _{JC}) ⁽⁴⁾			156		°C/W

Notes:

1. Test conditions unless otherwise noted: V_{DD} = +3.3V, Temp = +25°C, 75Ω test system.
2. Measured in a 50Ω system.
3. Exceeds maximum operating input power. Not recommended for operation.
4. Thermal Resistance is referenced to back of EVB.

Performance Plots

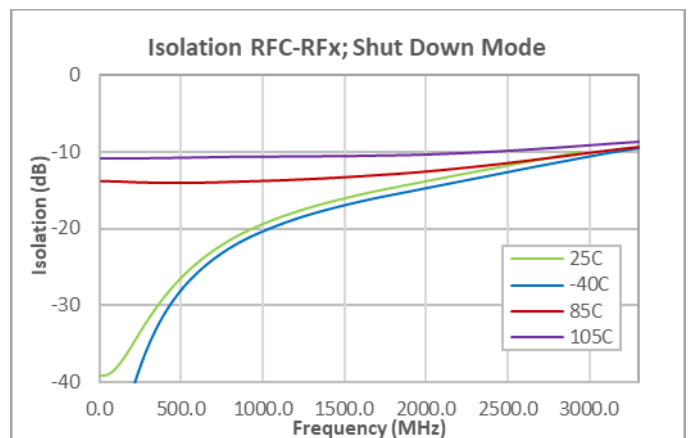
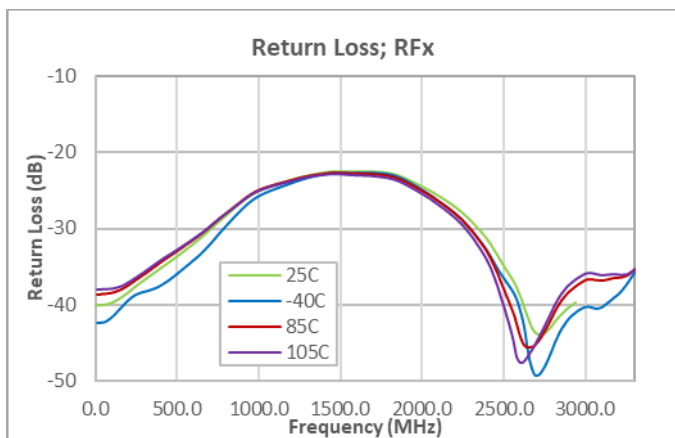
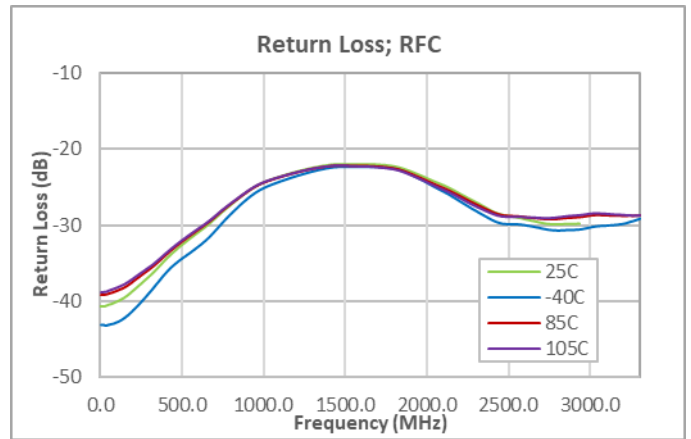
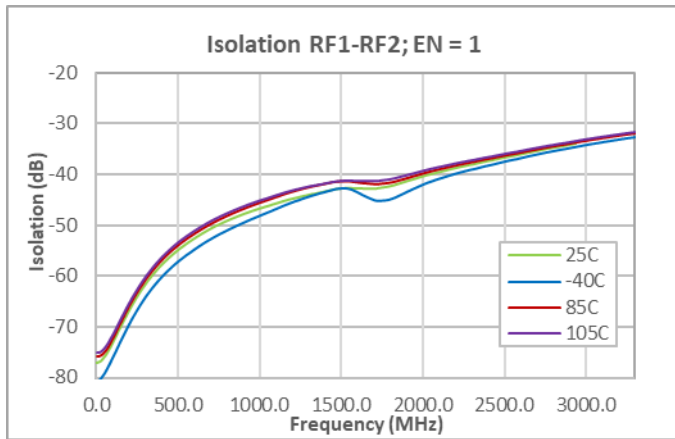
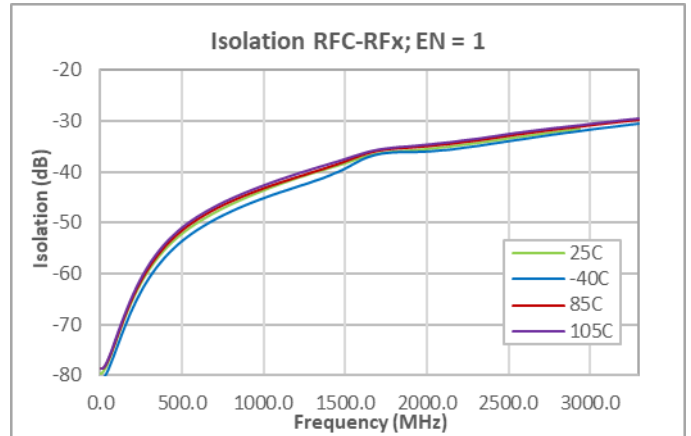
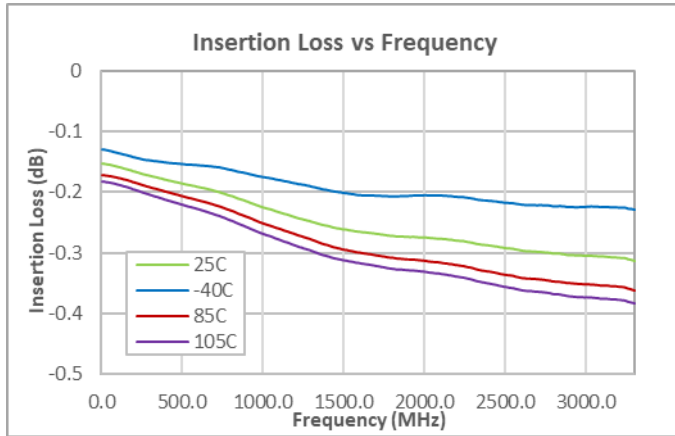

Test Conditions:

1. Test conditions unless otherwise noted: $V_{DD} = +3.3V$, $Z_0 = 75\Omega$

Performance Plots (cont'd.)

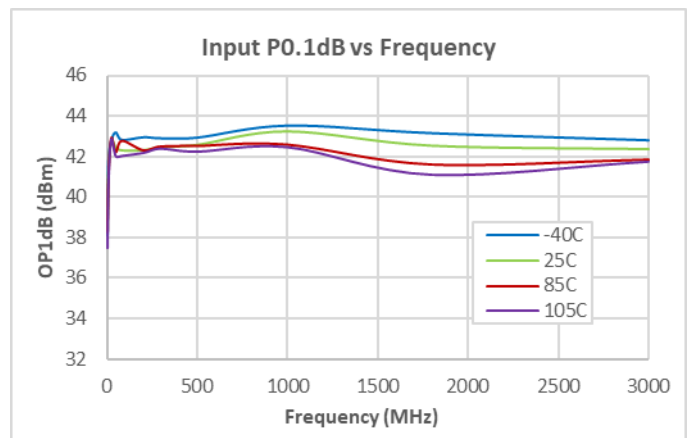
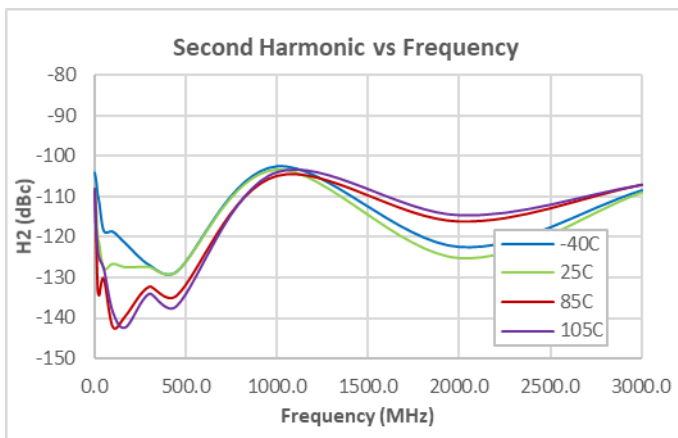
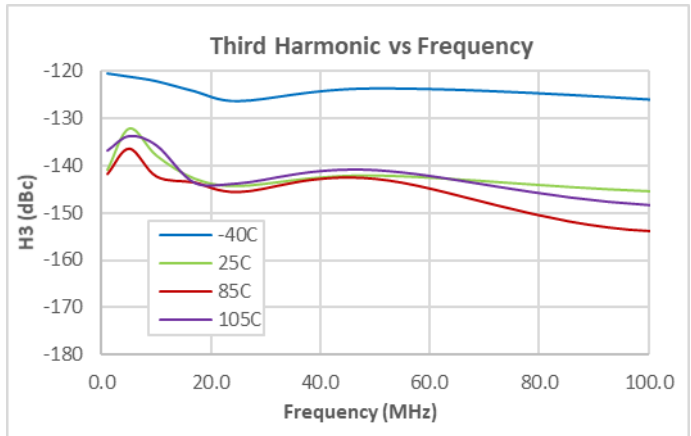
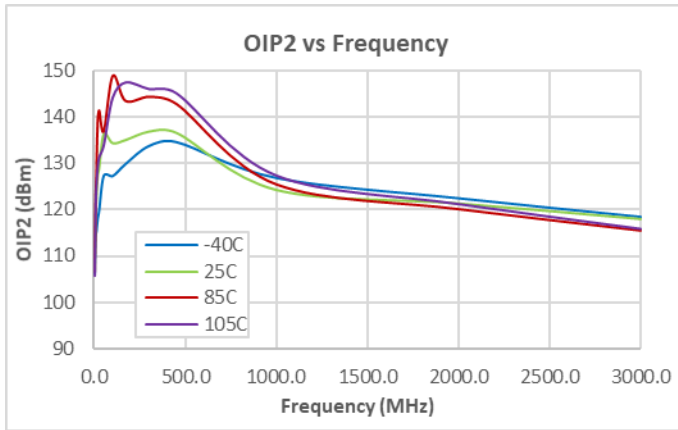
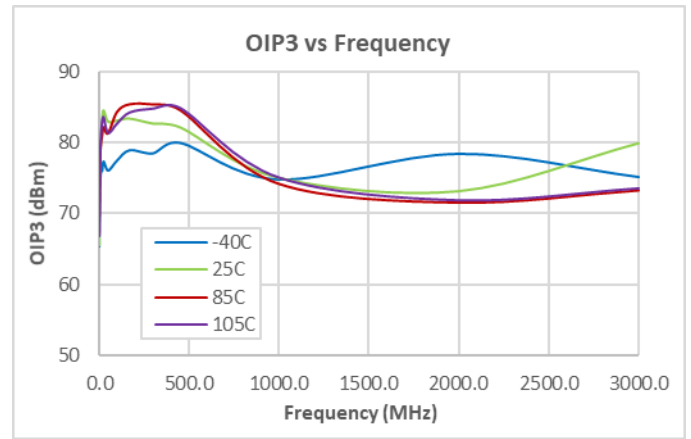
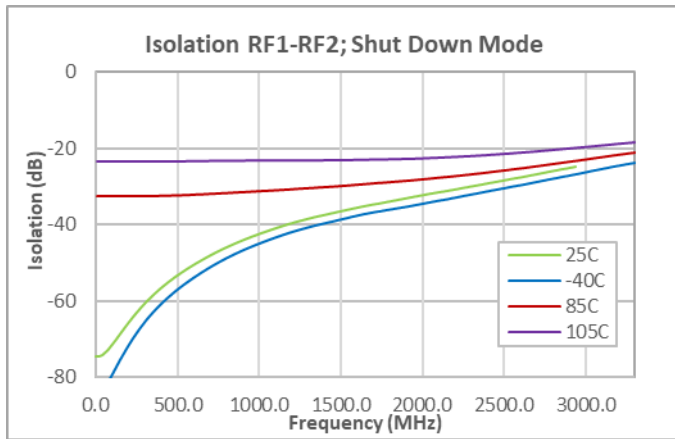

Test Conditions:

1. Test conditions unless otherwise noted: $V_{DD} = +3.3V$, $Z_0 = 75\Omega$
2. IIP3, IP2: 75 Ω , +12dBm per tone.
3. Input P0.1dB exceeds maximum operating input power. Not recommended for operation.

Performance Plots (cont'd.)

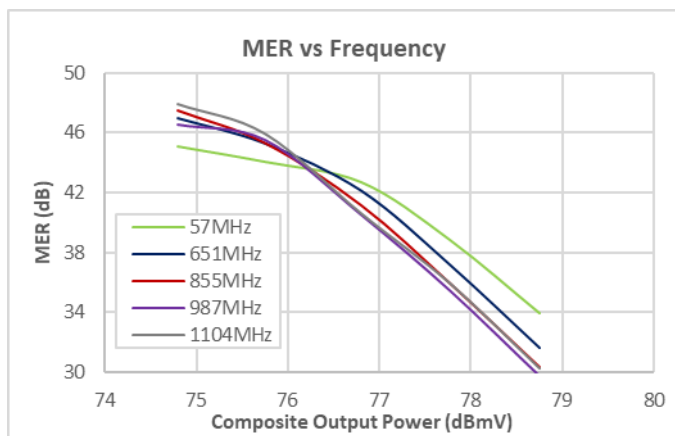
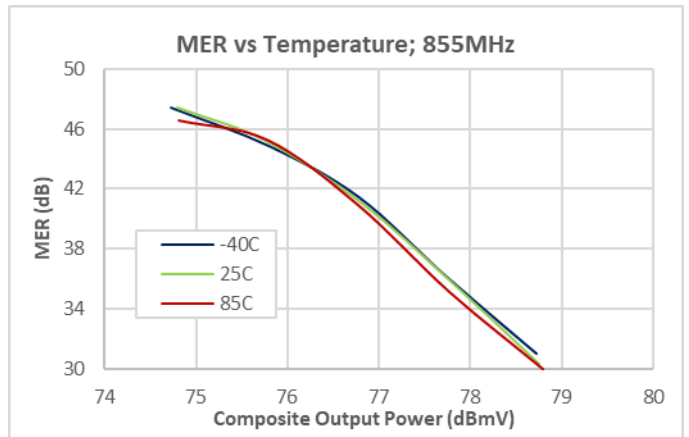
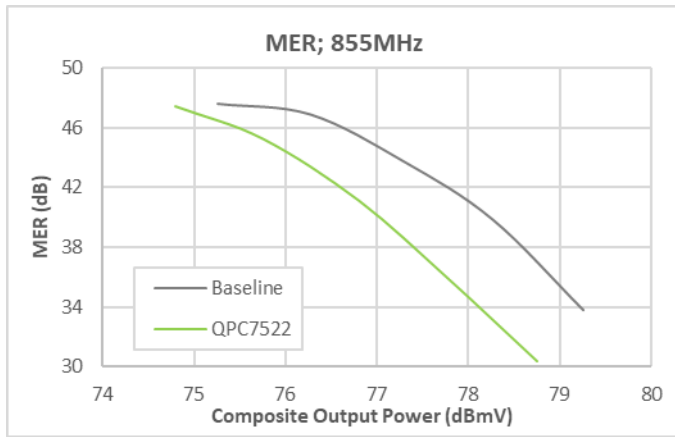
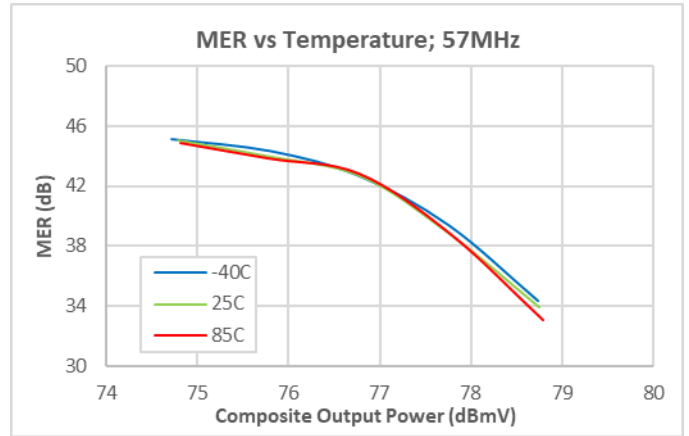
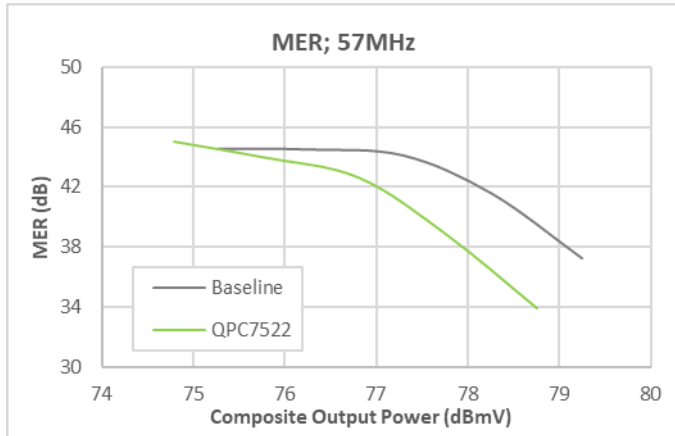

Test Conditions:

1. Test conditions unless otherwise noted: $V_{DD} = +3.3V$, $Z_0 = 75\Omega$
2. MER: 190 QAM Ch; 57-1215MHz; 10dB Tilt; ITU-T J.83, Annex B; Baseline represents RFPD3580 output.

Evaluation Board Schematic

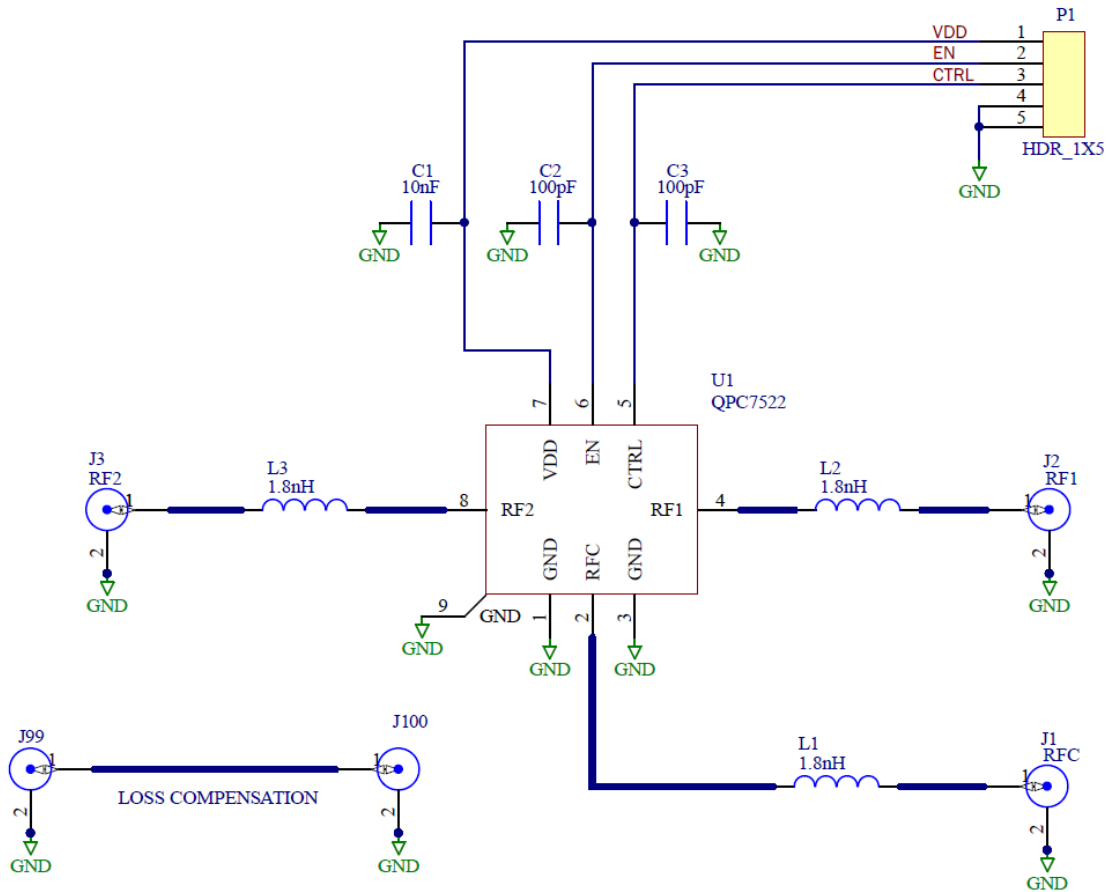

Evaluation Board Bill of Materials

Ref Designator	Description	Manufacturer	Part Number
PCB	PCB, QPC7522	Qorvo	QPC7522-4000(C)
U1	QPC7522 Switch	Qorvo	QPC7522
C1	CAP, 0.01uF, 10%, 25V, X8R, 0402	TDK	C1005X8R1E103K050BA
C2, C3	CAP, 100pF, 1%, 50V, C0G, 0402	AVX Asia. Ltd.	04025A101FAT2A
L1, L2, L3	IND, 1.8nH, +/-0.1nH, T/F, 0402	Murata Electronics	LQP15MN1N8B02D
P1	CONN, HDR, ST, PLRZD, 5-PIN, 0.100"	AMP	640454-5
J1, J2, J3, J99, J100	CONN, F FEM EDGE MOUNT, 75 OHMS, 0.065"	Genesis Technology USA	GT20-300204

Evaluation Board Layout

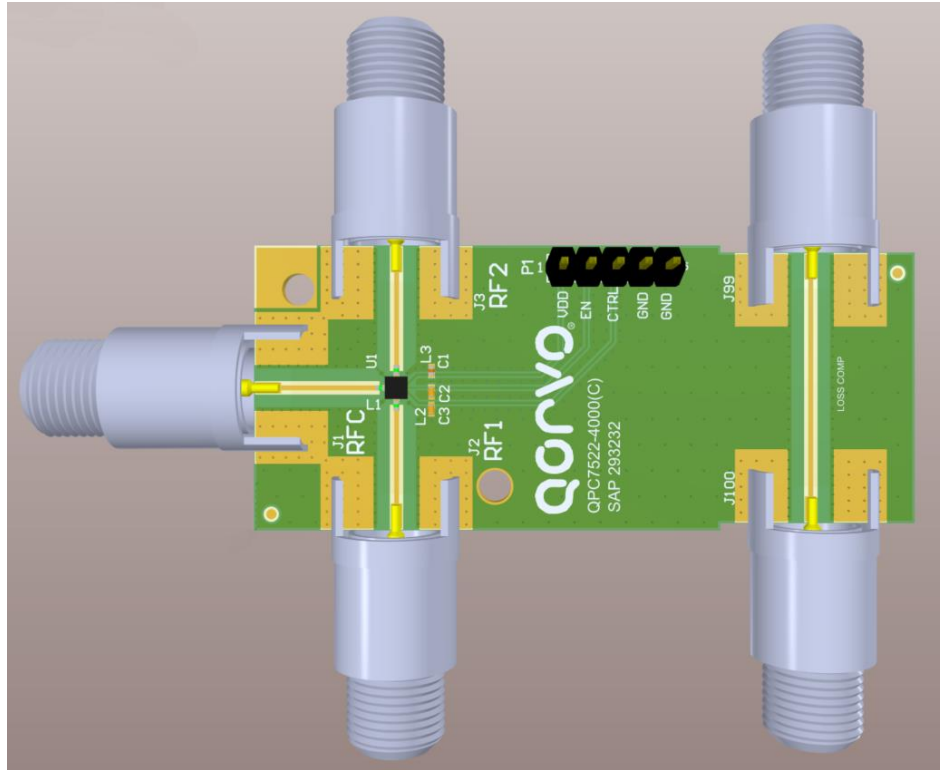

EVB PCB Material and Stack-up

Board Material: 0.020" RO4003C, $\epsilon_r=3.38$
 Final Plating: 0.5oz Copper
 Board Dimension: 1.1" x 2.55"
 Total Thickness: 50.2 mils

Layer	Name	Material	Thickness	Constant
1	Top Overlay			
2	Top Solder	Solder Resist	0.40mil	3.5
3	Top Layer	Copper	0.70mil	
4	Dielectric1	RO4003C	20.00mil	3.38
5	MidLayer1	Copper	1.40mil	
6	Dielectric2	370HR	4.22mil	3.7
7	MidLayer2	Copper	1.40mil	
8	Dielectric3	370HR	21.00mil	4.34
9	Bottom Layer	Copper	0.70mil	
10	Bottom Solder	Solder Resist	0.40mil	3.5

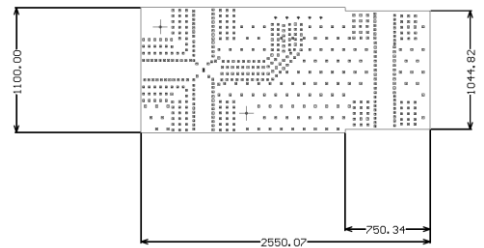

Pin Configuration and Description

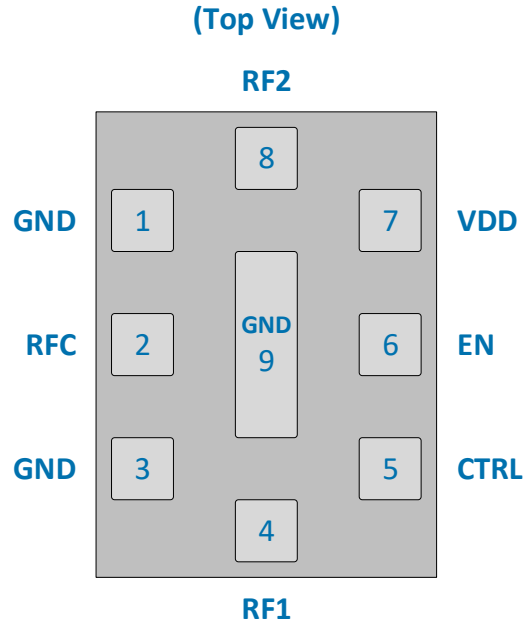

Pin Number	Label	Description
1, 3, 9	GND	Connect with low inductive path to ground
2	ANT	Single-Ended RF port
4	RF1	Single-Ended RF port
5	CTRL	Switch Logic control input
6	EN	Shutdown logic control input
7	V _{DD}	Supply Voltage
8	RF2	Single-Ended RF port

Notes:

1. Both RF pins must be held at 0V_{DC} or require external DC blocking capacitors.
2. The ground paddle must be soldered to the ground plane for proper switch performance.



Power Up/Down and Operational Controls

Scenario 1	Sequence for power up and power down from the supply that is connected to QPC7522 VDD Pin.
Power Up	Turn on VDD (supply), then EN, then CTRL. Then (20 mS or greater), apply RF signal
Power Down	Turn off RF signal, then CTRL, then EN, turn off VDD (supply)
Scenario 2	Sequence for going in and out of shutdown mode, keeping the VDD supply on, but disabling/enabling QPC7522 by the EN pin
Power Up	Turn on EN (enable), then CTRL, then (5 mS or greater), turn on RF Signal
Power Down	Turn off RF signal, then CTRL, then EN (disable)
Scenario 3	When changing switch positions between RF1 and RF2, no RF signal should be applied to any RF port while the CTRL is changing states
Switching Ports	Turn off RF signal, then change CTRL state, then wait (5 mS or greater), then turn on RF signal

Control Logic for Valid Operational States

State	V _{DD}	CTRL	EN	RF Path
1	2.4 V to 5.8 V	V _{HIGH}	V _{HIGH}	RFC – RF1
2	2.4 V to 5.8 V	V _{LOW}	V _{HIGH}	RFC – RF2
Shutdown	2.4 V to 5.8 V	X	V _{LOW}	Shutdown

Package Dimensions

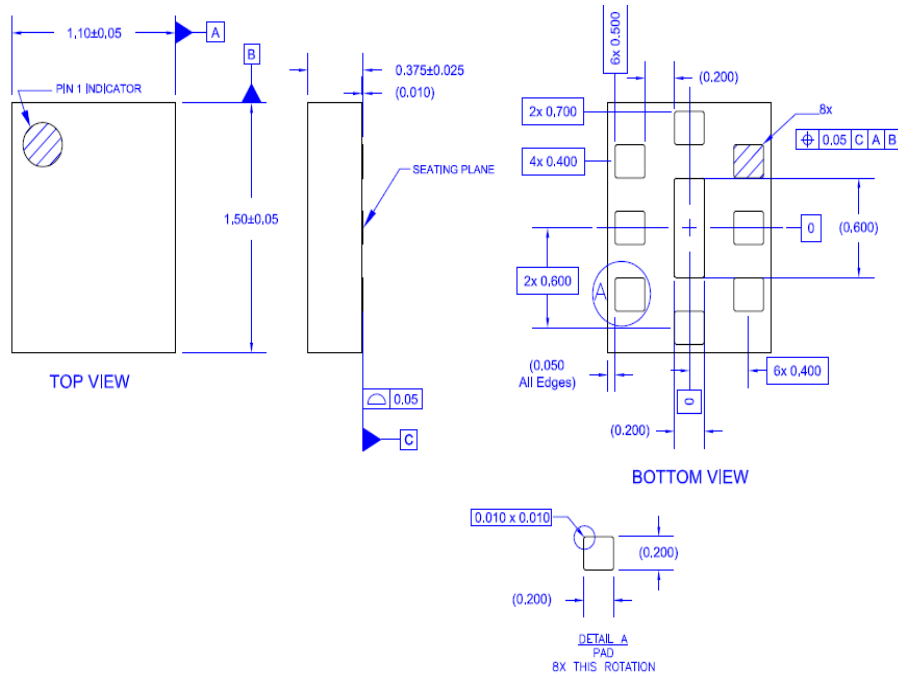

- Notes:
1. All dimensions are in millimeters. Angles are in degrees.
 2. The terminal #1 identifier and terminal numbering conform to JESD 95-1 SPP-012.

Package Marking

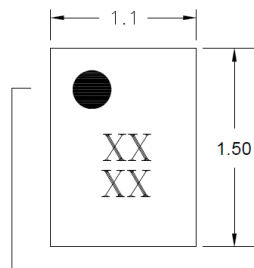

Pin 1 Indicator
XXXX
is the 4 digit Trace Code
assigned by sub-con

Unit: mm

Solderability

Compatible with both lead-free (260°C max. reflow temp.) soldering process.
Solder profiles available upon request.

Contact plating: Au plating 0.5 µm, over a 2 µm Ni Plating

Handling Precautions

Parameter	Rating	Standard
ESD – Human Body Model (HBM)	Class 2 (2000V)	ESDA / JEDEC JS-001-2012
ESD – Charged Device Model (CDM)	Class C3 (1000V)	JEDEC JESD22-C101F
MSL – Moisture Sensitivity Level	Level 2	IPC/JEDEC J-STD-020



Caution!
ESD-Sensitive Device

RoHS Compliance

This part is compliant with EU 2011/65/EU RoHS directive (Restrictions on the Use of Certain Hazardous Substances in Electrical and Electronic Equipment), as amended by Directive 2015/863/EU. This product also has the following attributes:

- Lead Free
- Halogen Free (Chlorine, Bromine)
- Antimony Free
- TBBP-A (C₁₅H₁₂Br₄O₂) Free
- SVHC Free
- Qorvo Green



Contact Information

For the latest specifications, additional product information, worldwide sales and distribution locations:

Tel: 1-844-890-8163

Web: www.qorvo.com

Email: customer.support@qorvo.com

Important Notice

The information contained in this Data Sheet and any associated documents (“Data Sheet Information”) is believed to be reliable; however, Qorvo makes no warranties regarding the Data Sheet Information and assumes no responsibility or liability whatsoever for the use of said information. All Data Sheet Information is subject to change without notice. Customers should obtain and verify the latest relevant Data Sheet Information before placing orders for Qorvo® products. Data Sheet Information or the use thereof does not grant, explicitly, implicitly or otherwise any rights or licenses to any third party with respect to patents or any other intellectual property whether with regard to such Data Sheet Information itself or anything described by such information.

DATA SHEET INFORMATION DOES NOT CONSTITUTE A WARRANTY WITH RESPECT TO THE PRODUCTS DESCRIBED HEREIN, AND QORVO HEREBY DISCLAIMS ANY AND ALL WARRANTIES WITH RESPECT TO SUCH PRODUCTS WHETHER EXPRESS OR IMPLIED BY LAW, COURSE OF DEALING, COURSE OF PERFORMANCE, USAGE OF TRADE OR OTHERWISE, INCLUDING THE IMPLIED WARRANTIES OF MERCHANTABILITY AND FITNESS FOR A PARTICULAR PURPOSE. Without limiting the generality of the foregoing, Qorvo® products are not warranted or authorized for use as critical components in medical, life-saving, or life-sustaining applications, or other applications where a failure would reasonably be expected to cause severe personal injury or death. Applications described in the Data Sheet Information are for illustrative purposes only. Customers are responsible for validating that a particular product described in the Data Sheet Information is suitable for use in a particular application.

© 2020 Qorvo US, Inc. All rights reserved. This document is subject to copyright laws in various jurisdictions worldwide and may not be reproduced or distributed, in whole or in part, without the express written consent of Qorvo US, Inc. | QORVO® is a registered trademark of Qorvo US, Inc.

X-ON Electronics

Largest Supplier of Electrical and Electronic Components

Click to view similar products for [RF Development Tools](#) category:

Click to view products by [Qorvo](#) manufacturer:

Other Similar products are found below :

[MAAM-011117](#) [MAAP-015036-DIEEV2](#) [EV1HMC1113LP5](#) [EV1HMC6146BLC5A](#) [EV1HMC637ALP5](#) [EVAL-ADG919EBZ](#) [ADL5363-EVALZ](#) [LMV228SDEVAL](#) [SKYA21001-EVB](#) [SMP1331-085-EVB](#) [EV1HMC618ALP3](#) [EVAL01-HMC1041LC4](#) [MAAL-011111-000SMB](#) [MAAM-009633-001SMB](#) [MASW-000936-001SMB](#) [107712-HMC369LP3](#) [107780-HMC322ALP4](#) [SP000416870](#) [EV1HMC470ALP3](#) [EV1HMC520ALC4](#) [EV1HMC244AG16](#) [MAX2614EVKIT#](#) [124694-HMC742ALP5](#) [SC20ASATEA-8GB-STD](#) [MAX2837EVKIT+](#) [MAX2612EVKIT#](#) [MAX2692EVKIT#](#) [EV1HMC629ALP4E](#) [SKY12343-364LF-EVB](#) [108703-HMC452QS16G](#) [EV1HMC863ALC4](#) [EV1HMC427ALP3E](#) [119197-HMC658LP2](#) [EV1HMC647ALP6](#) [ADL5725-EVALZ](#) [MAX2371EVKIT#](#) [106815-HMC441LM1](#) [EV1HMC1018ALP4](#) [UXN14M9PE](#) [MAX2016EVKIT](#) [EV1HMC939ALP4](#) [MAX2410EVKIT](#) [MAX2204EVKIT+](#) [EV1HMC8073LP3D](#) [SIMSA868-DKL](#) [SIMSA868C-DKL](#) [SKY65806-636EK1](#) [SKY68020-11EK1](#) [SKY67159-396EK1](#) [SKY66181-11-EK1](#)