

Product Overview

The Qorvo QPD1000 is a 15W (P_{3dB}), 50Ω-input matched discrete GaN on SiC HEMT which operates from 30MHz to 1.215 GHz. The integrated input matching network enables wideband gain and power performance, while the output can be matched on board to optimize power and efficiency for any region within the band.

The device is housed in a 5 x 6 mm leadless SMT package that saves real estate of already space-constrained handheld radios.

Lead-free and ROHS compliant

Evaluation boards are available upon request.

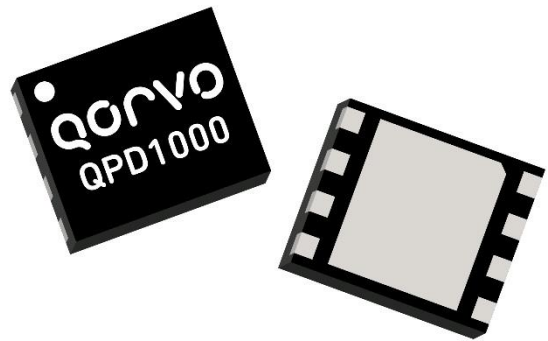

5 x 6 x 1.09 mm QFN

Functional Block Diagram

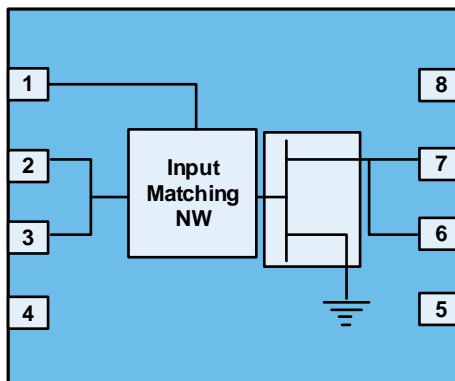

Key Features

- Frequency: 30 MHz to 1.215 GHz
 - Output Power (P_{3dB})¹: 24 W
 - Linear Gain¹: 19 dB
 - Typical PAE_{3dB}¹: 78 %
 - Operating Voltage: 28 V
 - Low thermal resistance package
 - CW and Pulse capable
 - 5 x 6 mm package
- Note 1: @ 1 GHz

Applications

- Military radar
- Civilian radar
- Land mobile and military radio communications
- Test instrumentation
- Wideband or narrowband amplifiers
- Jammers

Ordering info

Part No.	Description
QPD1000	0.03–1.215 GHz RF Transistor
QPD1000PCB4B01	0.05 – 1.00 GHz EVB
QPD1000PCB4B02	0.20 – 1.20 GHz EVB

Absolute Maximum Ratings¹

Parameter	Rating	Units
Breakdown Voltage, BV_{DG}	+100	V
Gate Voltage Range, V_G	-7 to +2	V
Drain Current	3	A
Power Dissipation, CW, P_{DISS}	32.4	W
RF Input Power, CW, 1 GHz, $T = 25\text{ }^\circ\text{C}$	+30	dBm
Storage Temperature	-65 to +150	$^\circ\text{C}$

Notes:

- Exceeding any one or a combination of the Absolute Maximum Rating conditions may cause permanent damage to the device. Extended application of Absolute Maximum Rating conditions to the device may reduce device reliability.

Recommended Operating Conditions¹

Parameter	Min	Typ	Max	Units
Operating Temp. Range	-40	+25	+85	$^\circ\text{C}$
Drain Voltage Range, V_D	+12	+28	+32	V
Drain Bias Current, I_{DQ}	-	50	-	mA
Gate Voltage, V_G^2	-4	-2.8	-1	V

Notes:

- Electrical performance is measured under conditions noted in the electrical specifications table. Specifications are not guaranteed over all recommended operating conditions.
- To be adjusted to desired I_{DQ}

Pulsed Characterization – Load-Pull Performance – Power Tuned¹

Parameters	Typical Values				Unit
	0.6	0.8	1.0	1.2	
Frequency, F	0.6	0.8	1.0	1.2	GHz
Linear Gain, G_{LIN}	19.9	20.0	19.0	17.2	dB
Output Power at 3dB compression point, P_{3dB}	43.7	43.8	43.8	43.8	dBm
Power-Added-Efficiency at 3dB compression point, PAE_{3dB}	62.4	56.5	61.6	59.5	%
Gain at 3dB compression point	16.9	17.0	16.0	14.2	dB

Notes:

- Test conditions unless otherwise noted: $V_D = +28\text{ V}$, $I_{DQ} = 50\text{ mA}$, $Temp = +25\text{ }^\circ\text{C}$

Pulsed Characterization – Load-Pull Performance – Efficiency Tuned¹

Parameters	Typical Values				Unit
	0.6	0.8	1.0	1.2	
Frequency, F	0.6	0.8	1.0	1.2	GHz
Linear Gain, G_{LIN}	20.4	20.9	19.3	17.1	dB
Output Power at 3dB compression point, P_{3dB}	41.9	41.5	41.1	41.0	dBm
Power-Added-Efficiency at 3dB compression point, PAE_{3dB}	72.4	74.6	78.2	71.1	%
Gain at 3dB compression point, G_{3dB}	17.4	17.9	16.3	14.1	dB

Notes:

- Test conditions unless otherwise noted: $V_D = +28\text{ V}$, $I_{DQ} = 50\text{ mA}$, $Temp = +25\text{ }^\circ\text{C}$

RF Characterization – 0.05 – 1.00 GHz EVB Performance At 0.152 GHz¹

Parameter	Min	Typ	Max	Units
Output Power at 25 dBm Input Power	40	41.2	–	dBm
Drain Efficiency at 25 dBm Input Power	72	87.8	–	%
Gain at 25 dBm Input Power	14.5	16.2	–	dB

Notes:

1. $V_D = +28\text{ V}$, $I_{DQ} = 50\text{ mA}$, Temp = +25 °C, CW

RF Characterization – 0.05 – 1.00 GHz EVB Performance At 0.5 GHz¹

Parameter	Min	Typ	Max	Units
Output Power at 25 dBm Input Power	40.5	41.8	–	dBm
Drain Efficiency at 25 dBm Input Power	52	57.6	–	%
Gain at 25 dBm Input Power	15	16.8	–	dB
Gate Leakage: $V_D = +10\text{ V}$, $V_G = -3.7\text{ V}$	-7.92	–	–	mA

Notes:

1. $V_D = +28\text{ V}$, $I_{DQ} = 50\text{ mA}$, Temp = +25 °C, CW

RF Characterization – 0.05 – 1.00 GHz EVB Performance At 0.9 GHz¹

Parameter	Min	Typ	Max	Units
Output Power at 25 dBm Input Power	40.8	42.4	–	dBm
Drain Efficiency at 25 dBm Input Power	57	66.2	–	%
Gain at 25 dBm Input Power	15.5	17.4	–	dB

Notes:

1. $V_D = +28\text{ V}$, $I_{DQ} = 50\text{ mA}$, Temp = +25 °C, CW

RF Characterization – Mismatch Ruggedness at 1 GHz¹

Symbol	Parameter	dB Compression	Typical
VSWR	Impedance Mismatch Ruggedness	1	10:1

Notes:

1. Test conditions unless otherwise noted: $T_A = 25\text{ °C}$, $V_D = 28\text{ V}$, $I_{DQ} = 50\text{ mA}$, CW
Driving input power is determined at CW compression under matched condition at EVB output connector.

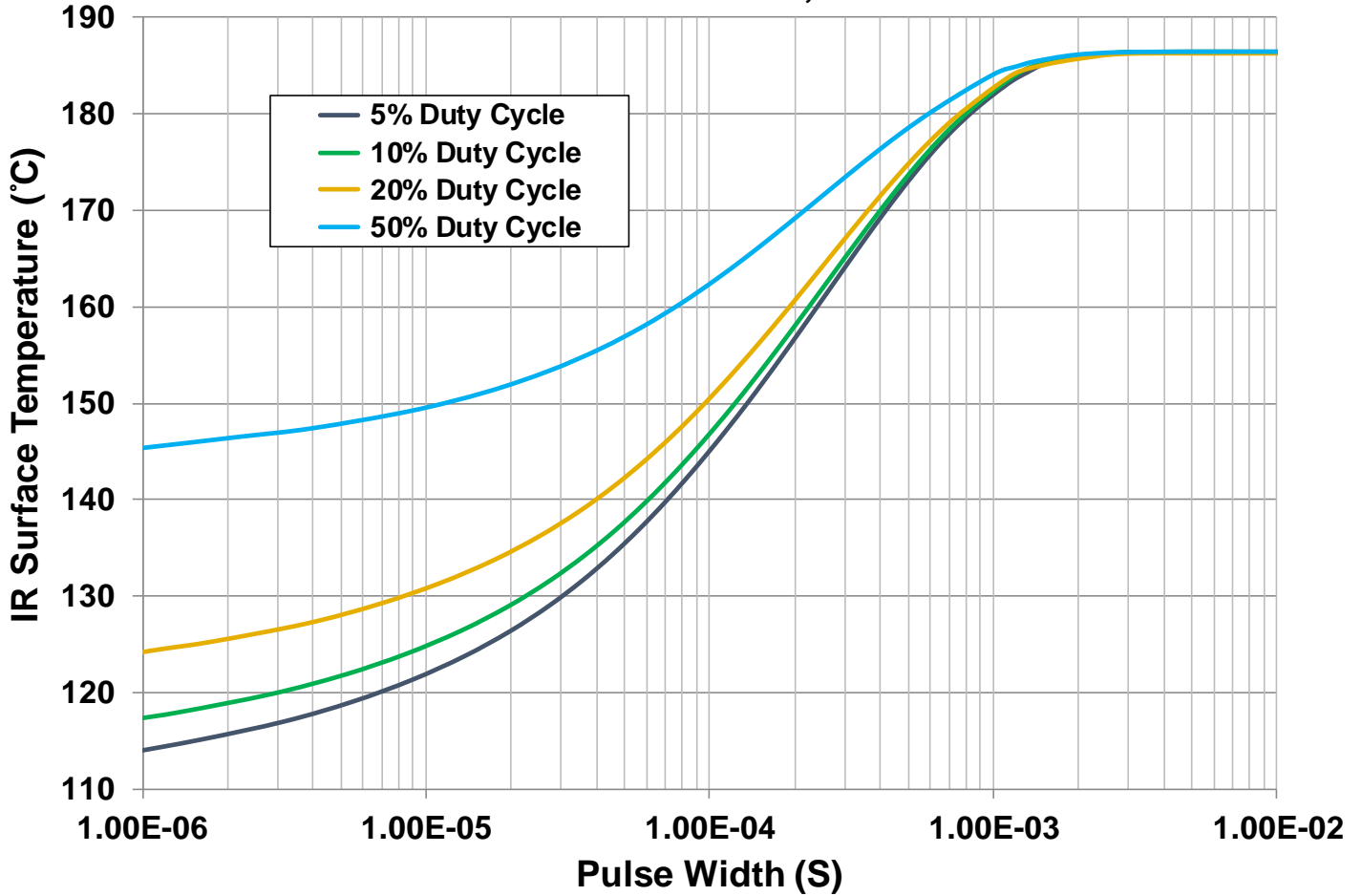
Thermal and Reliability Information – Pulsed
IR Surface Temperature vs. Pulse Width
QFN base fixed at 85 °C, P_{diss} = 28.8 W

Parameter	Conditions	Values	Units
Thermal Resistance, IR ¹ (θ_{JC})	85 °C back side temperature	2.08	°C/W
Peak IR Surface Temperature ¹ (T_{CH})	28.8 W P _{diss} , 100 uS PW, 5% DC	145	°C
Thermal Resistance, IR ¹ (θ_{JC})	85 °C back side temperature	2.15	°C/W
Peak IR Surface Temperature ¹ (T_{CH})	28.8 W P _{diss} , 100 uS PW, 10% DC	147	°C
Thermal Resistance, IR ¹ (θ_{JC})	85 °C back side temperature	2.26	°C/W
Peak IR Surface Temperature ¹ (T_{CH})	28.8 W P _{diss} , 100 uS PW, 20% DC	150	°C
Thermal Resistance, IR ¹ (θ_{JC})	85 °C back side temperature	2.67	°C/W
Peak IR Surface Temperature ¹ (T_{CH})	28.8 W P _{diss} , 100 uS PW, 50% DC	162	°C

¹Refer to the following document [GaN Device Channel Temperature, Thermal Resistance, and Reliability Estimates](#)

Thermal and Reliability Information – CW

**Peak IR Surface Temperature vs. CW P_{diss}
Base of QFN Package Fixed at 85 °C**

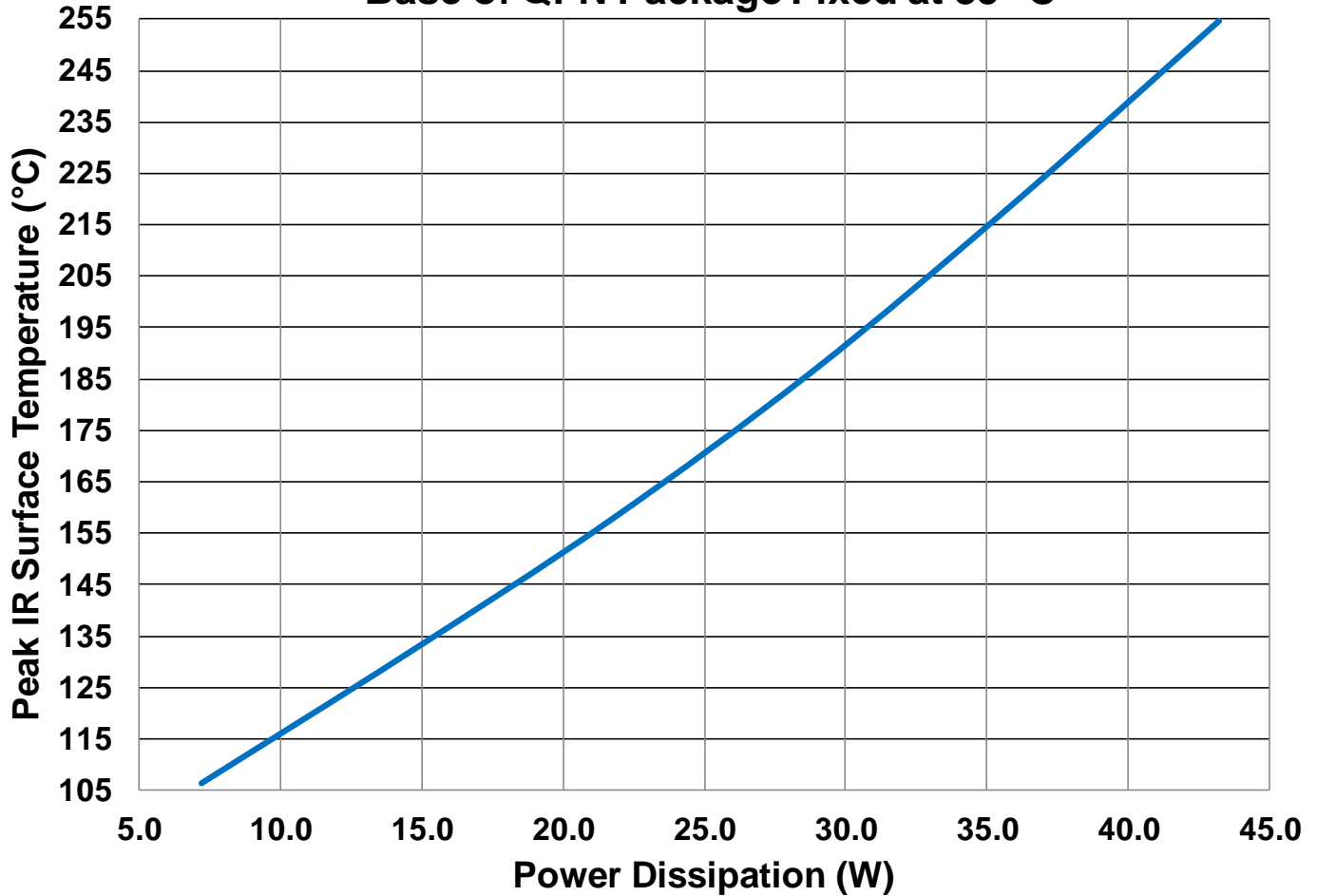

Parameter	Conditions	Values	Units
Thermal Resistance, IR ¹ (θ_{JC})	85 °C back side temperature	2.92	°C/W
Peak IR Surface Temperature ¹ (T_{CH})	7.2 W P _{diss} , CW	106	°C
Thermal Resistance, IR ¹ (θ_{JC})	85 °C back side temperature	3.19	°C/W
Peak IR Surface Temperature ¹ (T_{CH})	14.4 W P _{diss} , CW	131	°C
Thermal Resistance, IR ¹ (θ_{JC})	85 °C back side temperature	3.33	°C/W
Peak IR Surface Temperature ¹ (T_{CH})	21.6 W P _{diss} , CW	157	°C
Thermal Resistance, IR ¹ (θ_{JC})	85 °C back side temperature	3.51	°C/W
Peak IR Surface Temperature ¹ (T_{CH})	28.8 W P _{diss} , CW	186	°C
Thermal Resistance, IR ¹ (θ_{JC})	85 °C back side temperature	3.72	°C/W
Peak IR Surface Temperature ¹ (T_{CH})	36 W P _{diss} , CW	219	°C
Thermal Resistance, IR ¹ (θ_{JC})	85 °C back side temperature	3.94	°C/W
Peak IR Surface Temperature ¹ (T_{CH})	43.2 W P _{diss} , CW	255	°C

¹Refer to the following document [GaN Device Channel Temperature, Thermal Resistance, and Reliability Estimates](#)

Load-Pull Smith Charts^{1, 2, 3}

Notes:

1. $V_D = 28\text{ V}$, $I_{DQ} = 50\text{ mA}$, $100\text{ }\mu\text{S PW}$, 10% DC pulsed. Performance is at 3dB gain compression referenced to peak gain.
2. See page 17 for load-pull and source-pull reference planes. $50\text{-}\Omega$ load-pull TRL fixtures are built with 20-mil RO4350B material.
3. NaN means the impedances are either undefined or varying in load-pull system.

0.6 GHz, Load Pull

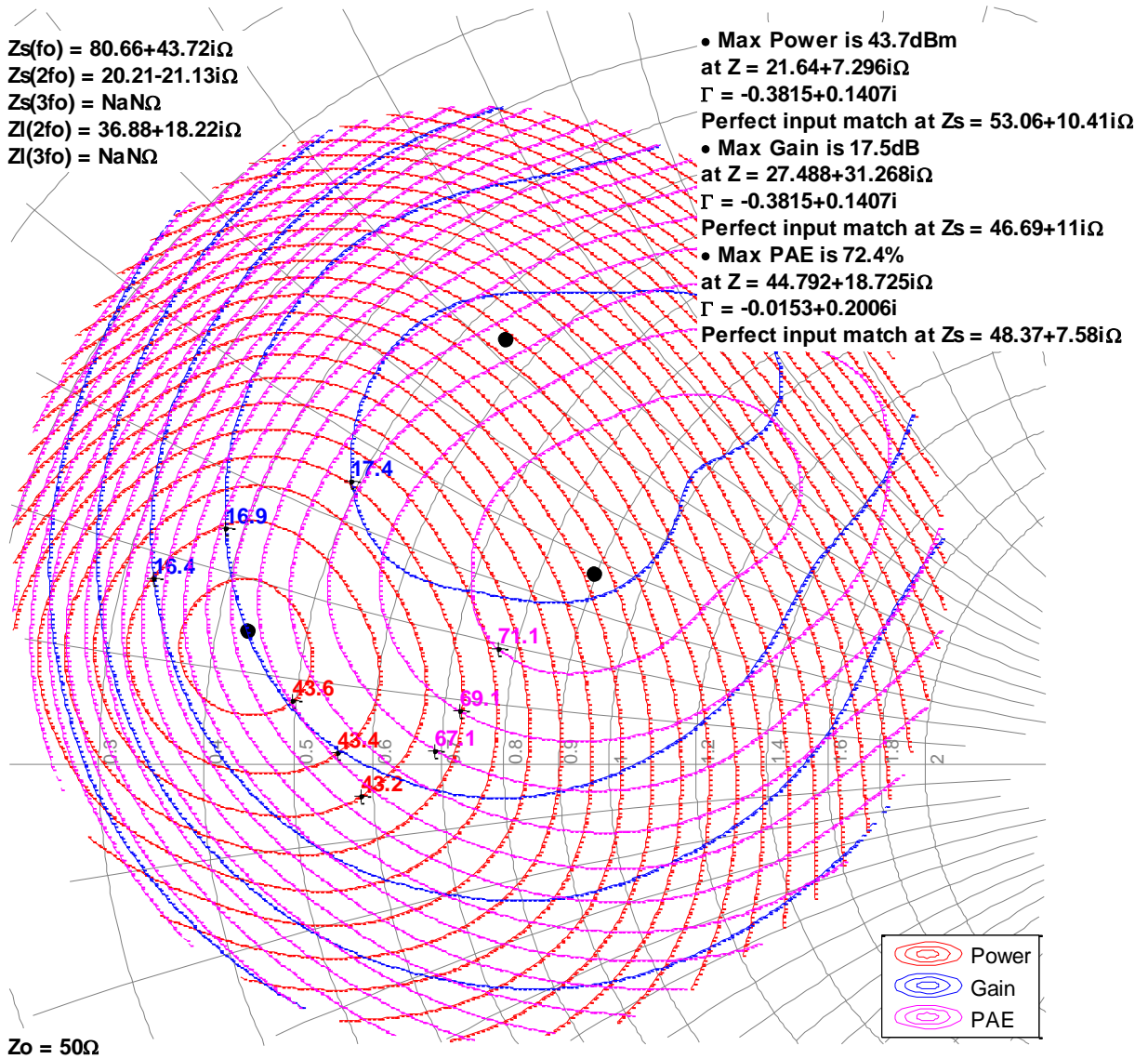

Load-Pull Smith Charts^{1, 2, 3}

Notes:

1. $V_D = 28\text{ V}$, $I_{DQ} = 50\text{ mA}$, $100\text{ }\mu\text{S PW}$, 10% DC pulsed. Performance is at 3dB gain compression referenced to peak gain.
2. See page 17 for load-pull and source-pull reference planes. $50\text{-}\Omega$ load-pull TRL fixtures are built with 20-mil RO4350B material.
3. NaN means the impedances are either undefined or varying in load-pull system.

0.8 GHz, Load Pull

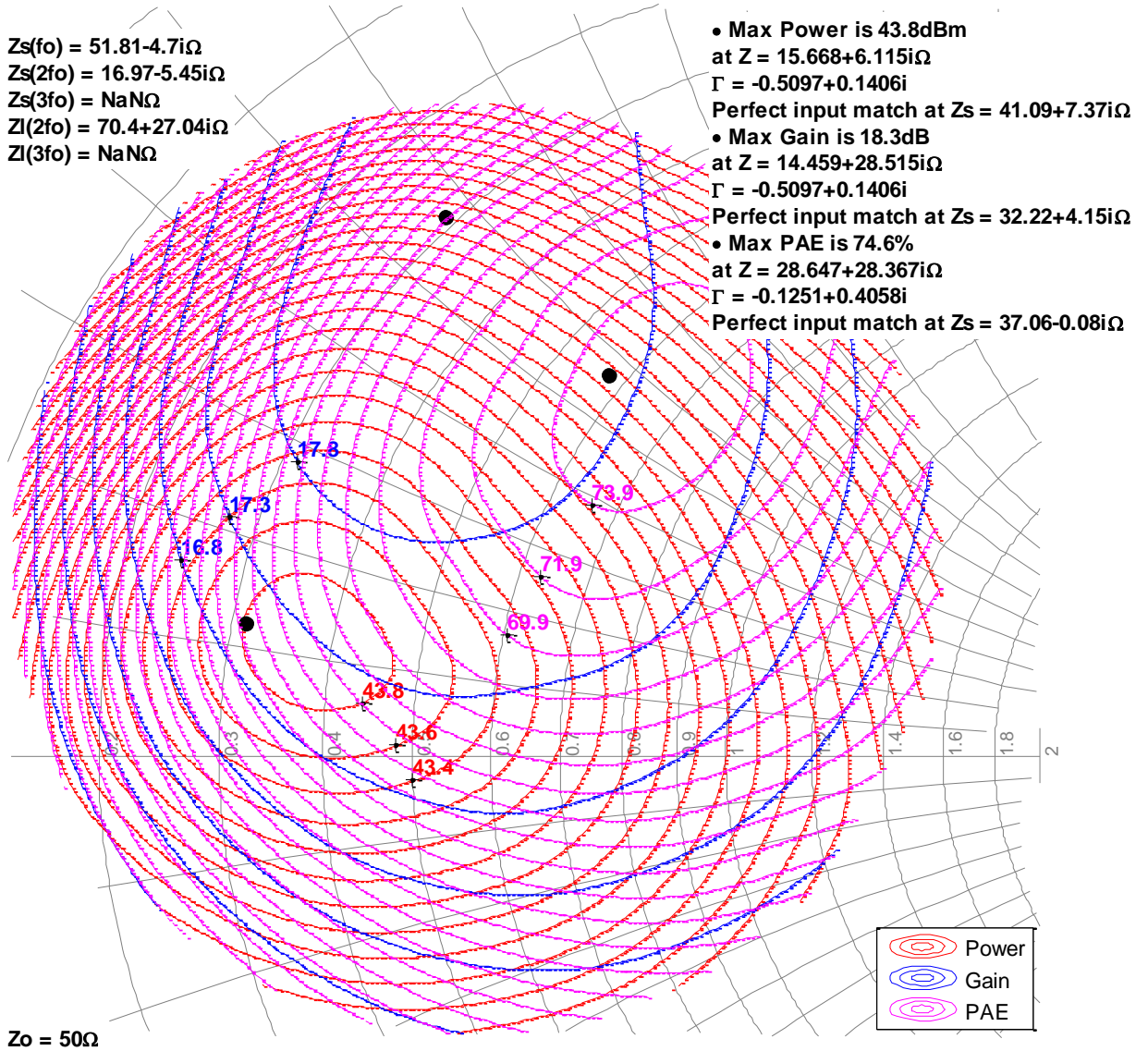

Load-Pull Smith Charts^{1, 2, 3}

Notes:

1. $V_D = 28\text{ V}$, $I_{DQ} = 50\text{ mA}$, $100\text{ }\mu\text{s PW}$, 10% DC pulsed. Performance is at 3dB gain compression referenced to peak gain.
2. See page 17 for load-pull and source-pull reference planes. $50\text{-}\Omega$ load-pull TRL fixtures are built with 20-mil RO4350B material.
3. NaN means the impedances are either undefined or varying in load-pull system.

1 GHz, Load Pull

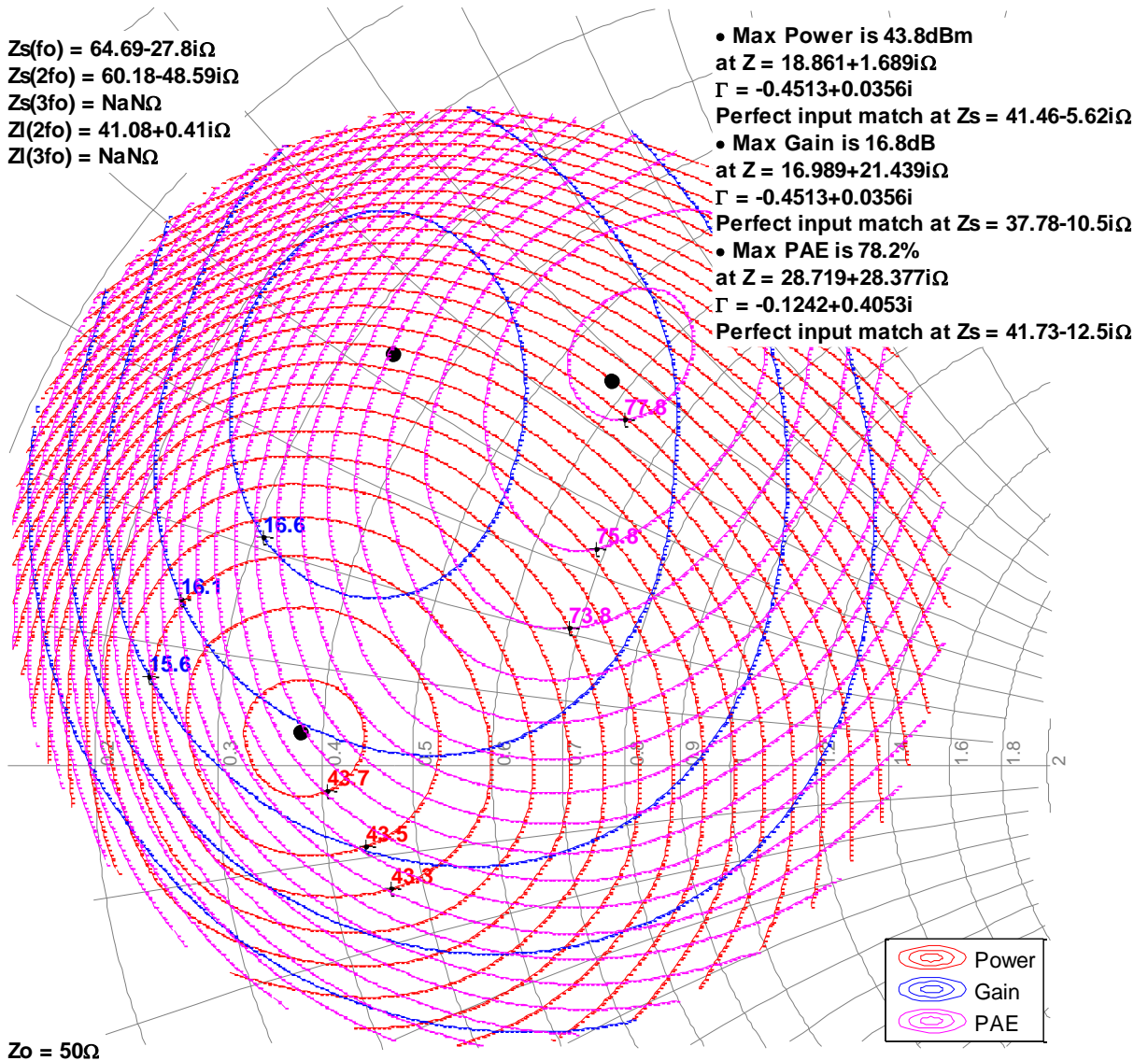

Load-Pull Smith Charts^{1, 2, 3}

Notes:

1. $V_D = 28\text{ V}$, $I_{DQ} = 50\text{ mA}$, $100\text{ }\mu\text{S PW}$, 10% DC pulsed. Performance is at 3dB gain compression referenced to peak gain.
2. See page 17 for load-pull and source-pull reference planes. $50\text{-}\Omega$ load-pull TRL fixtures are built with 20-mil RO4350B material.
3. NaN means the impedances are either undefined or varying in load-pull system.

1.2 GHz, Load Pull

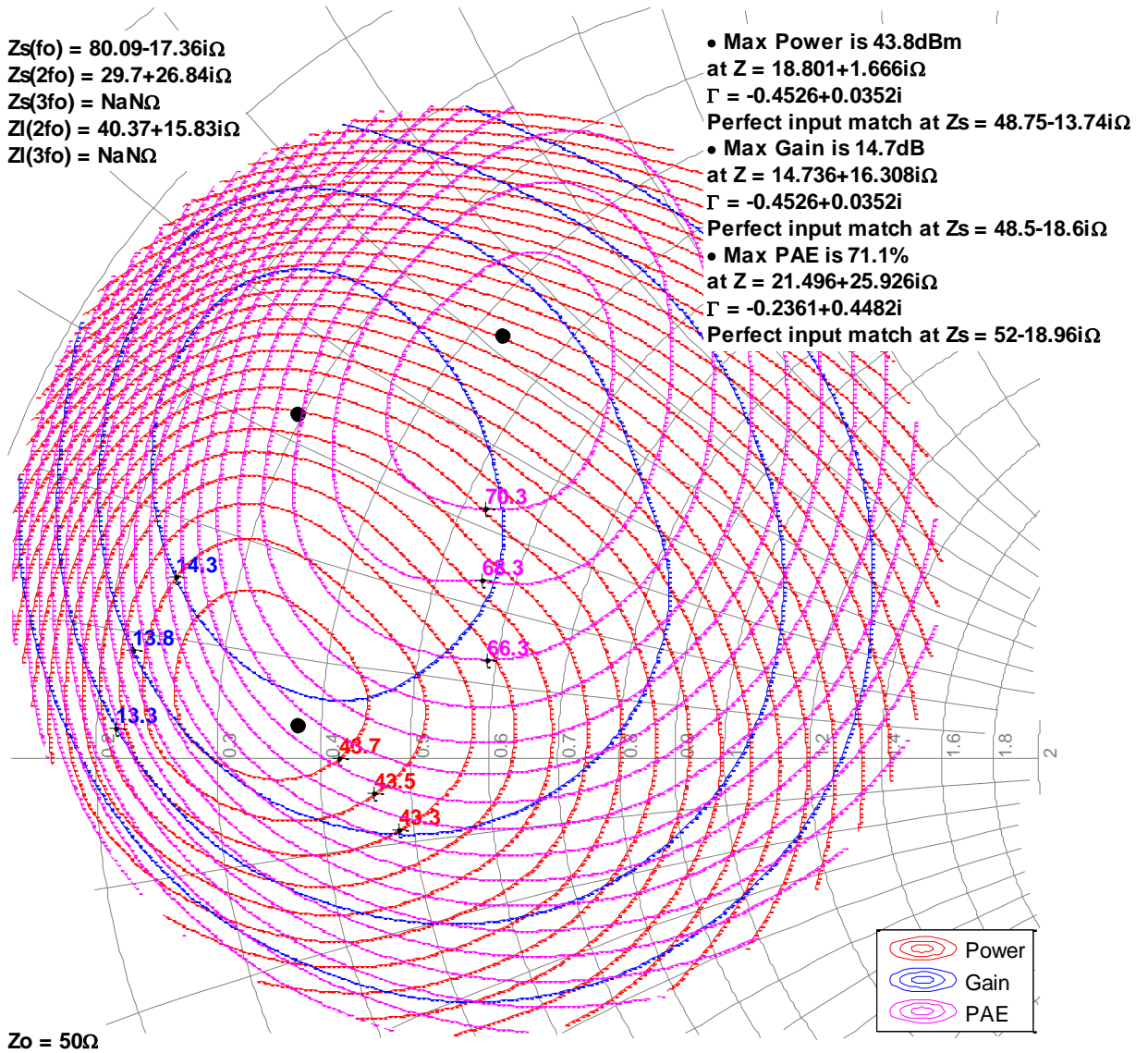

Typical Performance – Load-Pull Drive-up^{1, 2}

Notes:

- 100 μ s PW, 10% DC pulsed signal, $V_D = 28$ V, $I_{DQ} = 50$ mA
- See page 17 for load-pull and source-pull reference planes where the performance was measured.

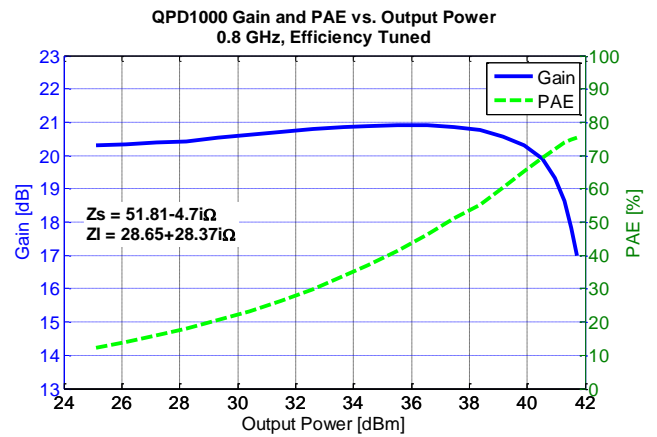
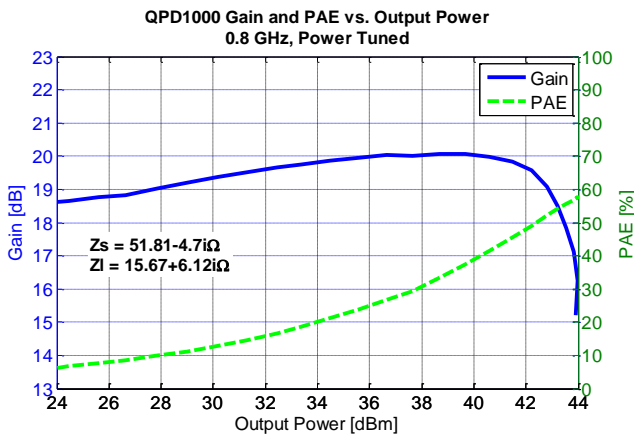
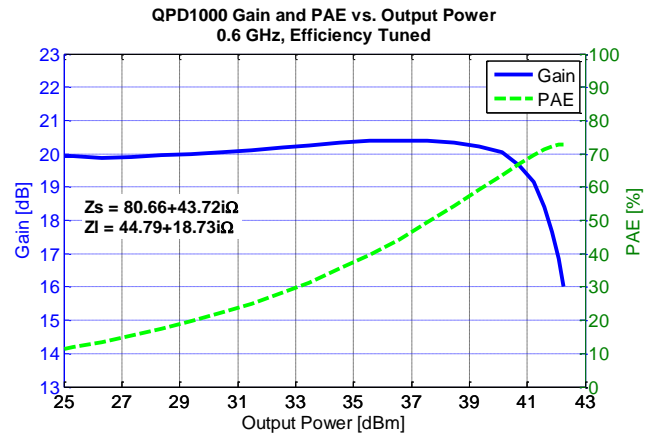
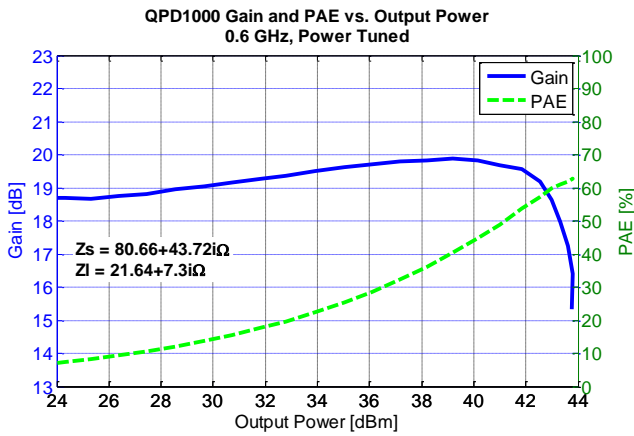

Typical Performance – Load-Pull Drive-up^{1,2}

Notes:

1. 100 μ s PW, 10% DC pulsed signal, $V_D = 28$ V, $I_{DQ} = 50$ mA
2. See page 17 for load-pull and source-pull reference planes where the performance was measured.

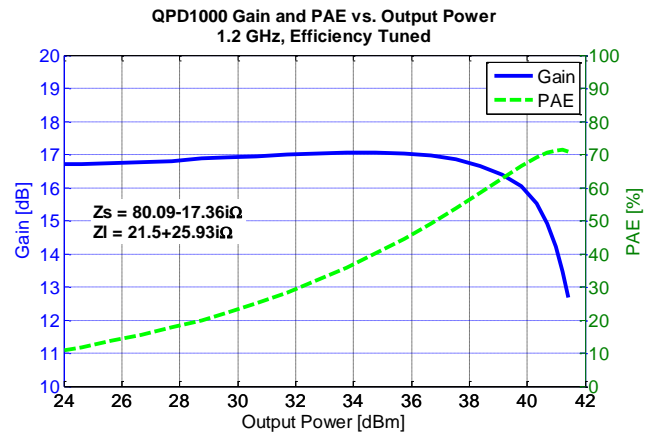
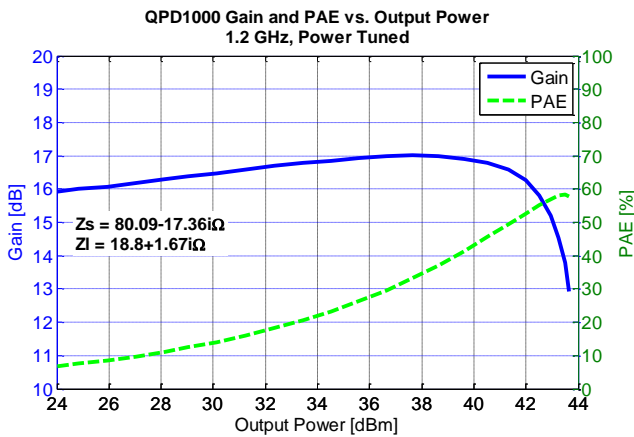
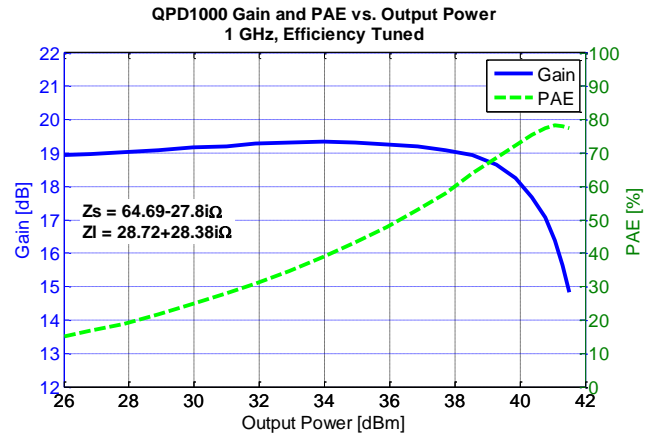
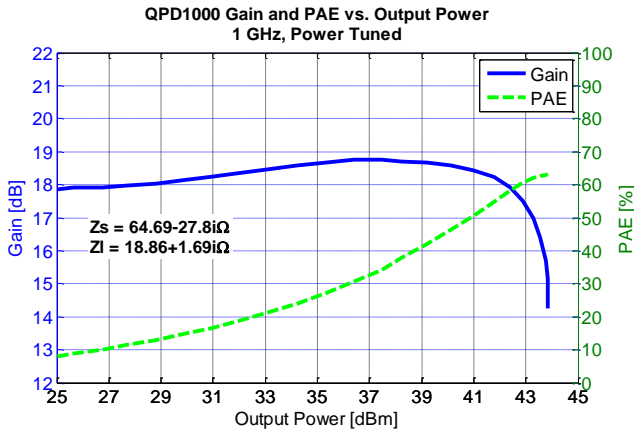

Power Drive-up Performance Over Temperatures Of 0.05 – 1.00 GHz EVB¹

Notes:

- $V_D = 28\text{ V}$, $I_{DQ} = 50\text{ mA}$, CW

P3dB Over Temperatures

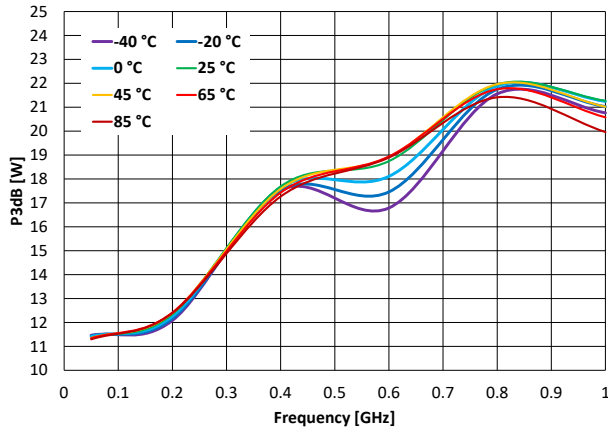

G3dB Over Temperatures

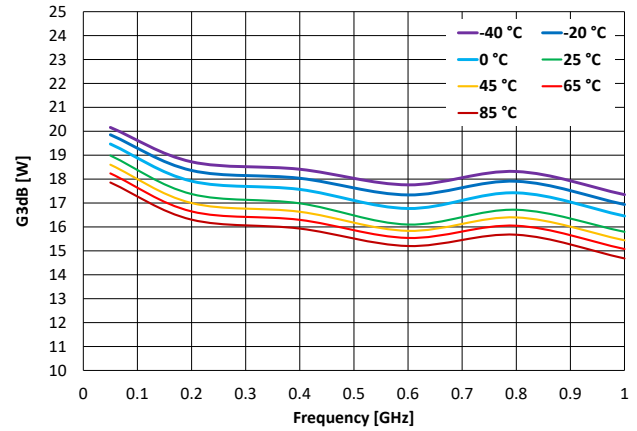

PAE3dB Over Temperatures

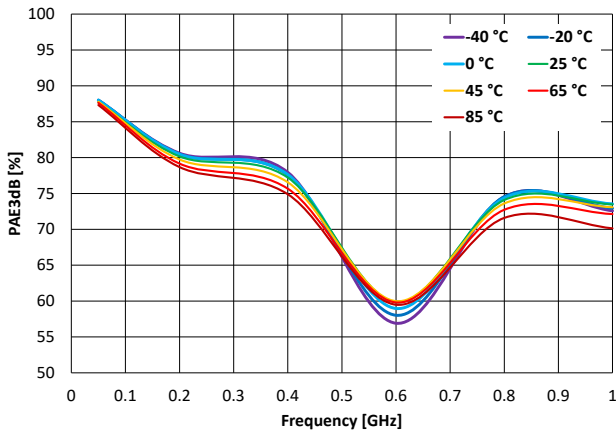

Dissipation Power @ 3dB Compression Over Temperatures

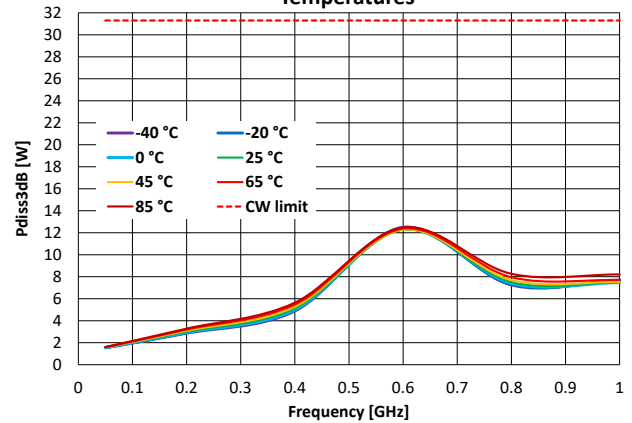

Power Drive-up Performance At 25 °C Of 0.05 – 1.00 GHz EVB¹

Notes:

1. $V_D = 28\text{ V}$, $I_{DQ} = 50\text{ mA}$, CW

P3dB at 25 °C

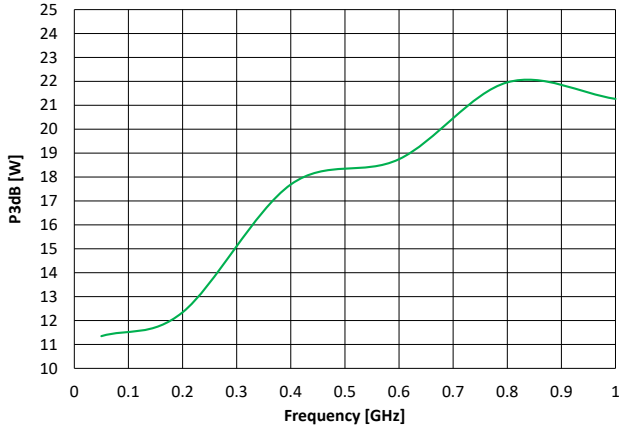

G3dB at 25 °C

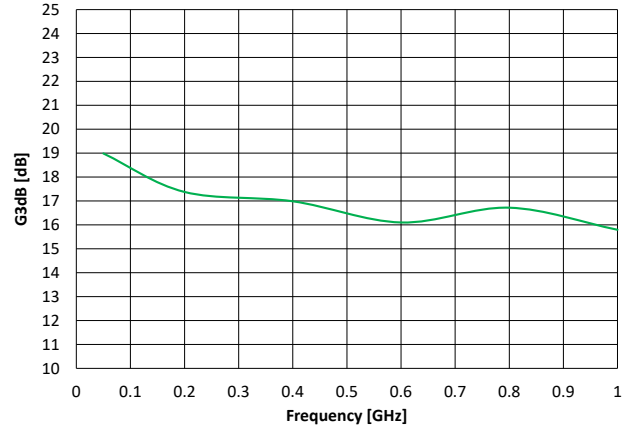

PAE3dB at 25 °C

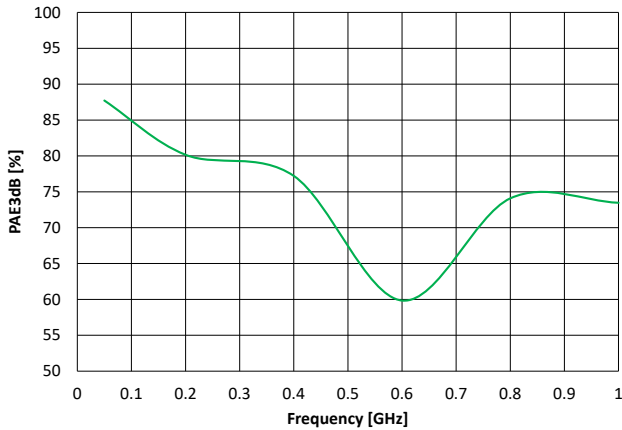

Dissipation Power @ 3dB compression at 25 °C

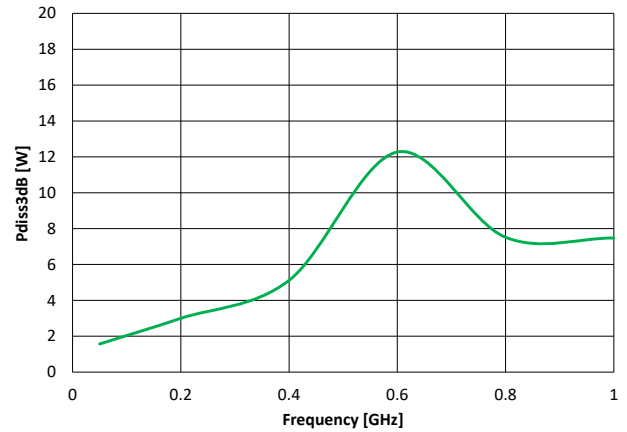

Two-Tone Performance At 25 °C Of 0.05 – 1.00 GHz EVB

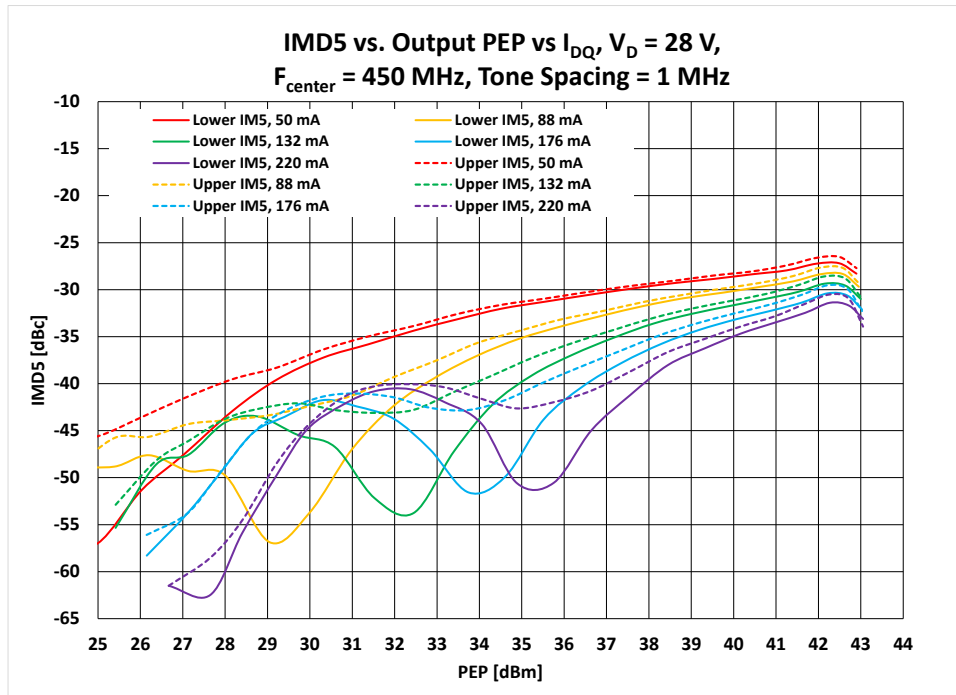
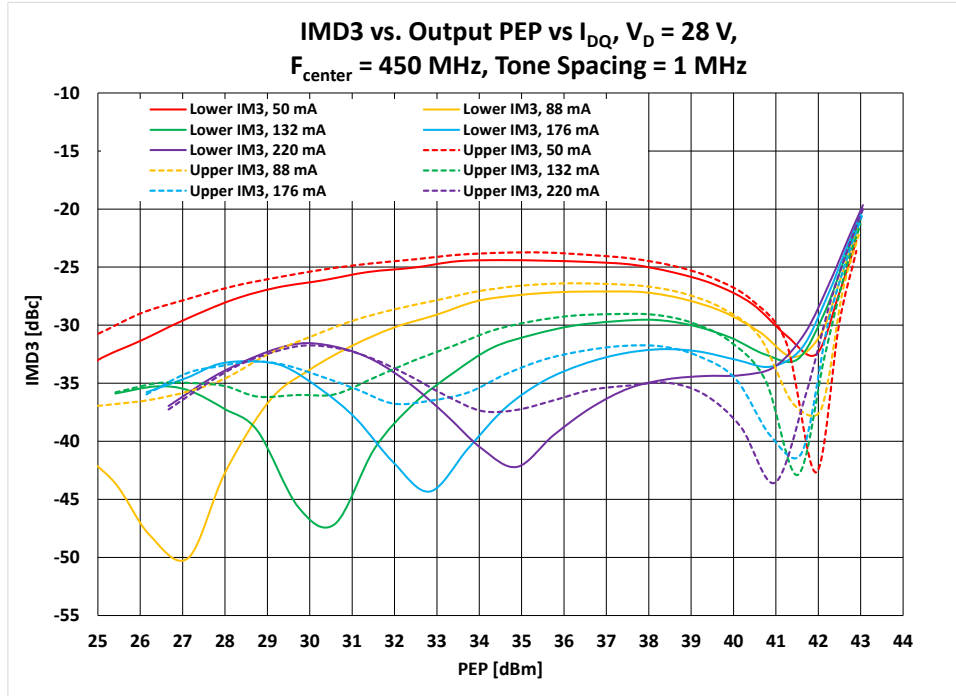

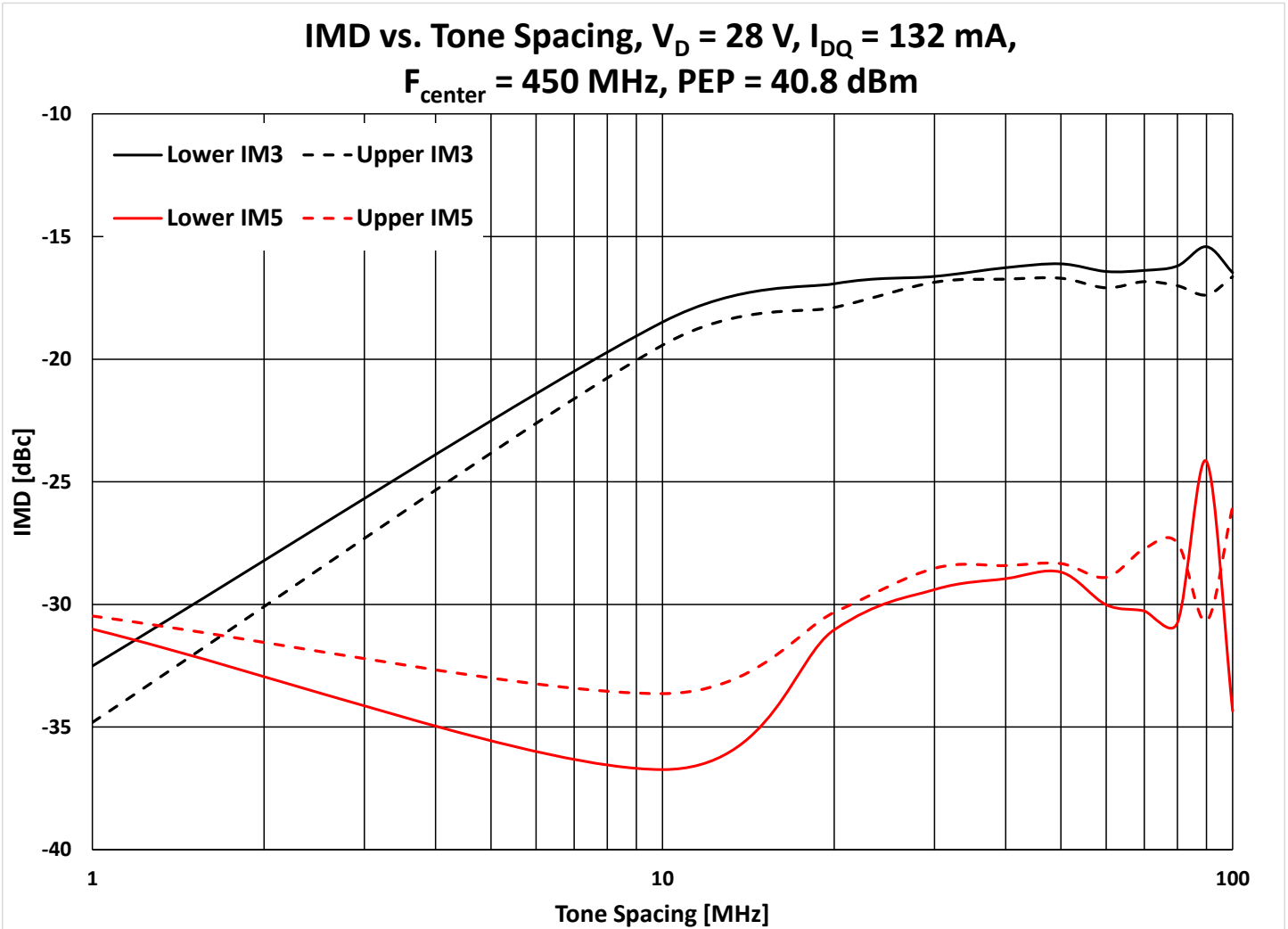
Two-Tone Performance At 25 °C Of 0.05 – 1.00 GHz EVB

Power Drive-up Performance At 25 °C Of 0.2 – 1.20 GHz EVB¹

Notes:

1. $V_D = 28\text{ V}$, $I_{DQ} = 50\text{ mA}$, CW

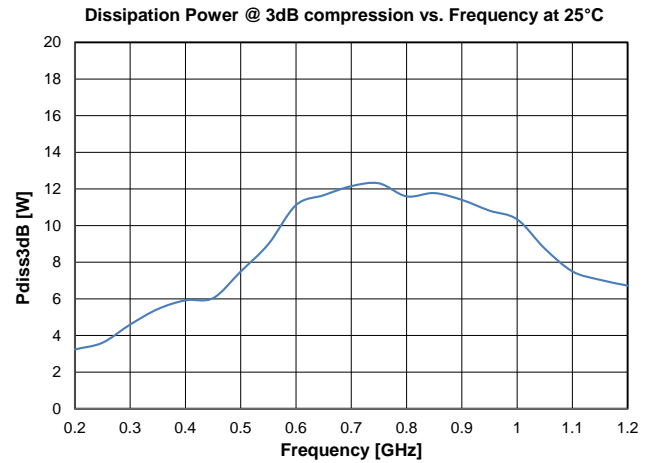
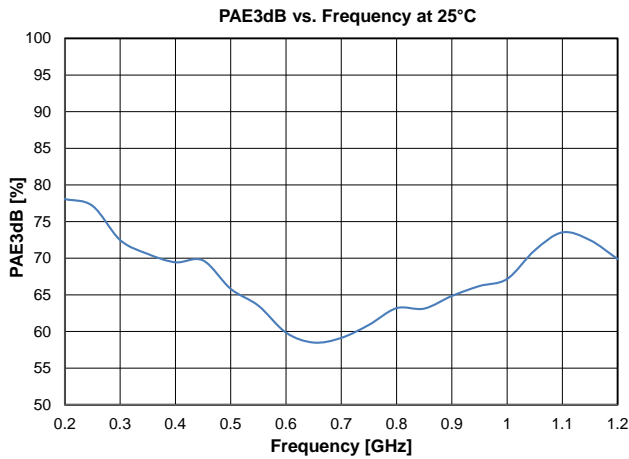
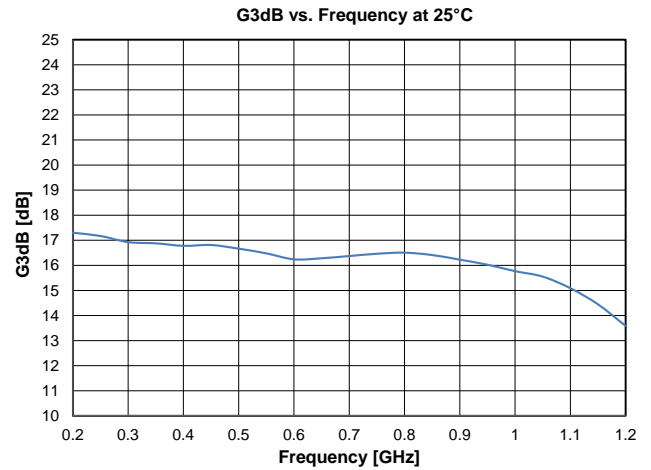
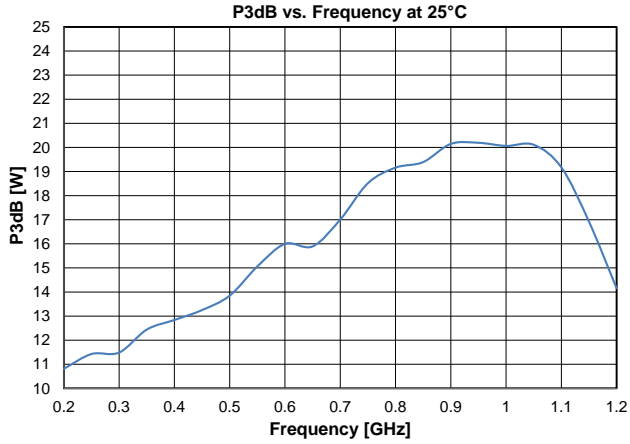

Pin Configuration and Description ¹

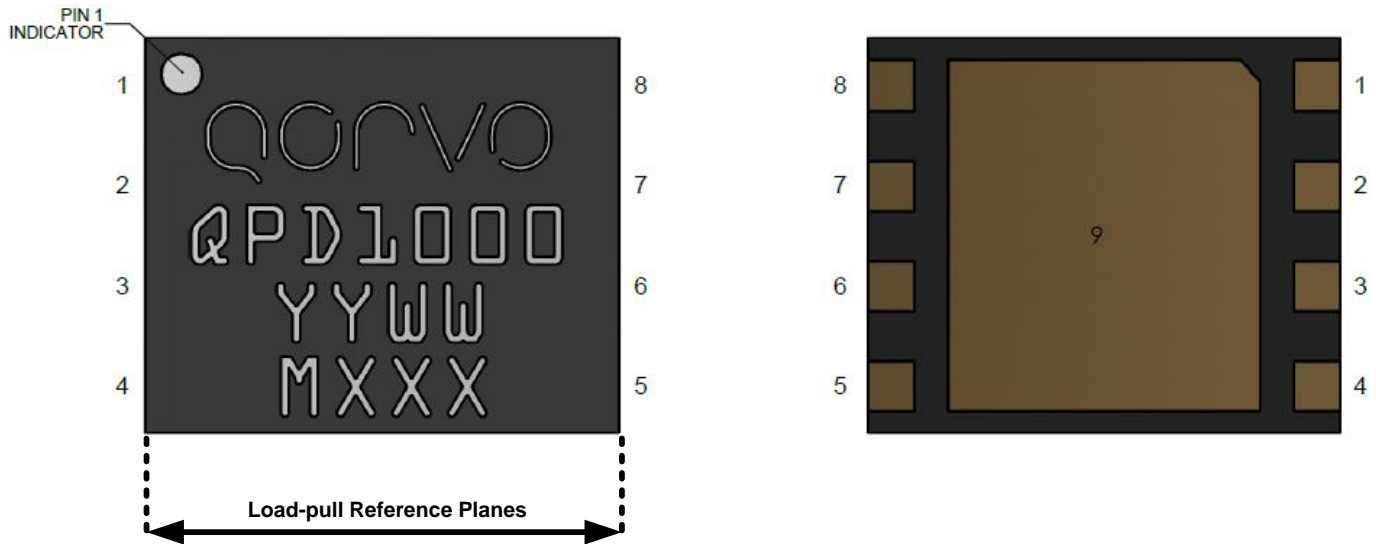

Notes:

- The QPD1000 will be marked with the “1000” designator and a lot code marked below the part designator. The “YY” represents the last two digits of the calendar year the part was manufactured, the “WW” is the work week of the assembly lot start, the “MXXX” is the production lot number.

Pin Description

Pin	Symbol	Description
2, 3	RF IN	Gate voltage / RF Input
6, 7	V_D / RF OUT	Drain voltage / RF Output
1	V_{GQ}	Gate bias supply
4, 5, 8	N/C	Not connected
9	Source	Source to be connected to ground

Package Marking and Dimensions^{1, 2, 3}

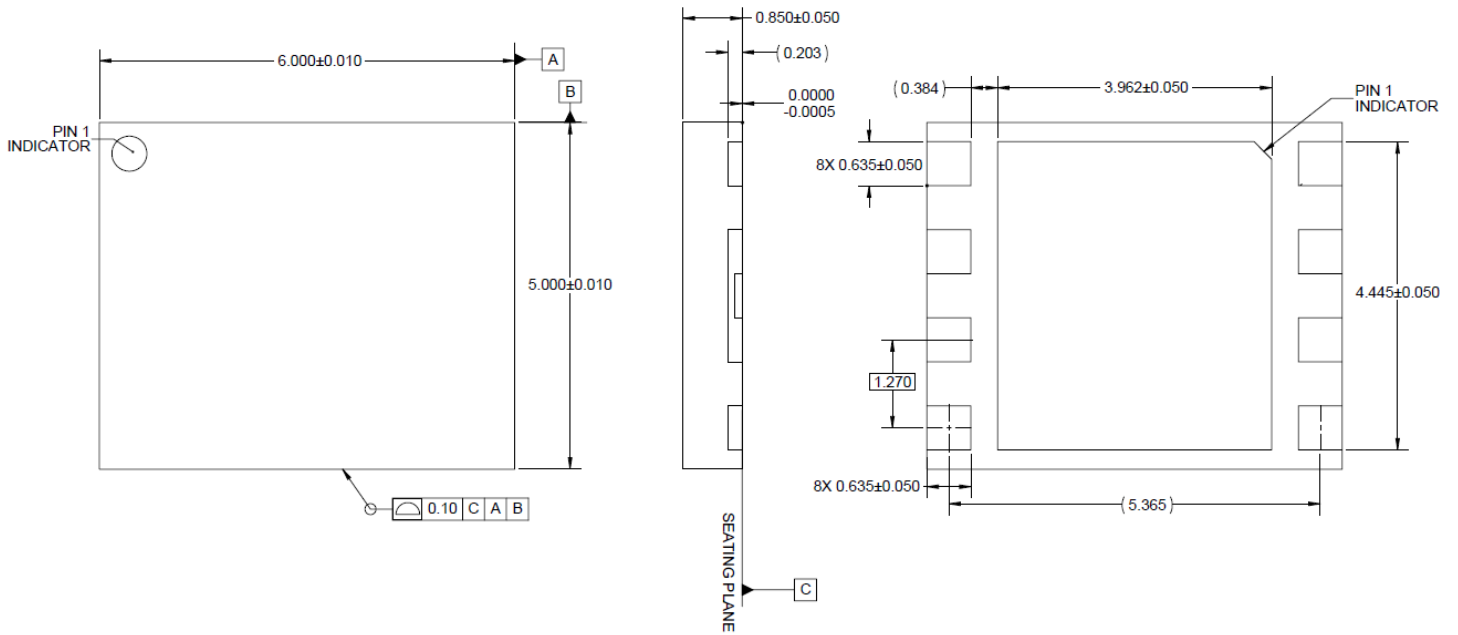

Notes:

1. All dimensions are in mm. Otherwise noted, the tolerance is ± 0.1 mm.
2. Package leads are gold plated.
3. Part is mold encapsulated.

Schematic - 0.05 – 1.00 GHz EVB

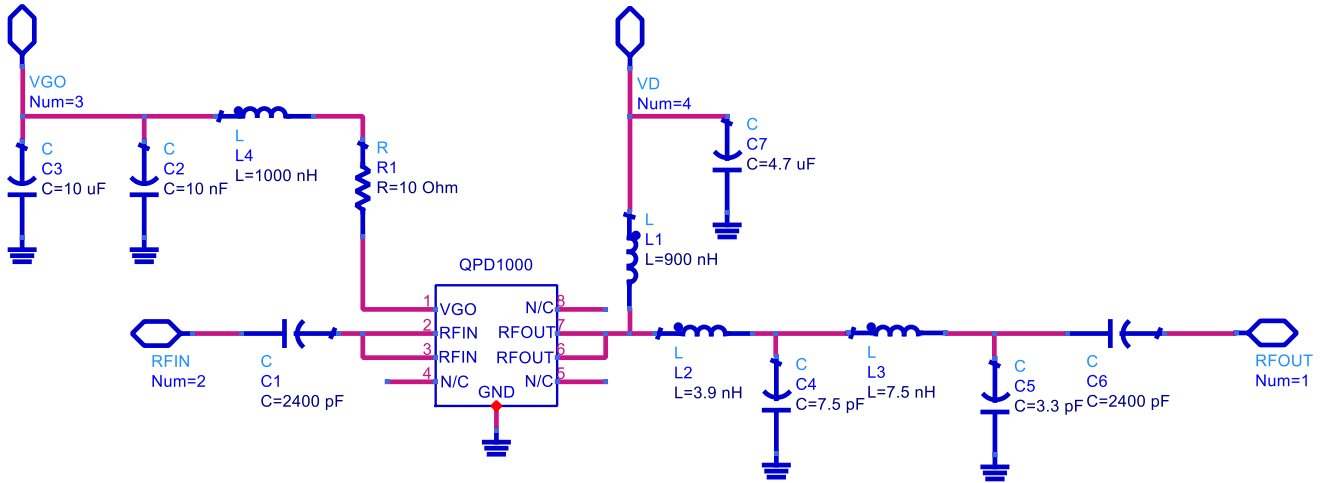

Bias-up Procedure

1. Set V_G to -4 V.
2. Set I_D current limit to 60 mA.
3. Apply 28 V V_D .
4. Slowly adjust V_G until I_D is set to 50 mA.
5. Set I_D current limit to 2 A
6. Apply RF.

Bias-down Procedure

1. Turn off RF signal.
2. Turn off V_D
3. Wait 2 seconds to allow drain capacitor to discharge
4. Turn off V_G

Schematic - 0.20 – 1.20 GHz EVB

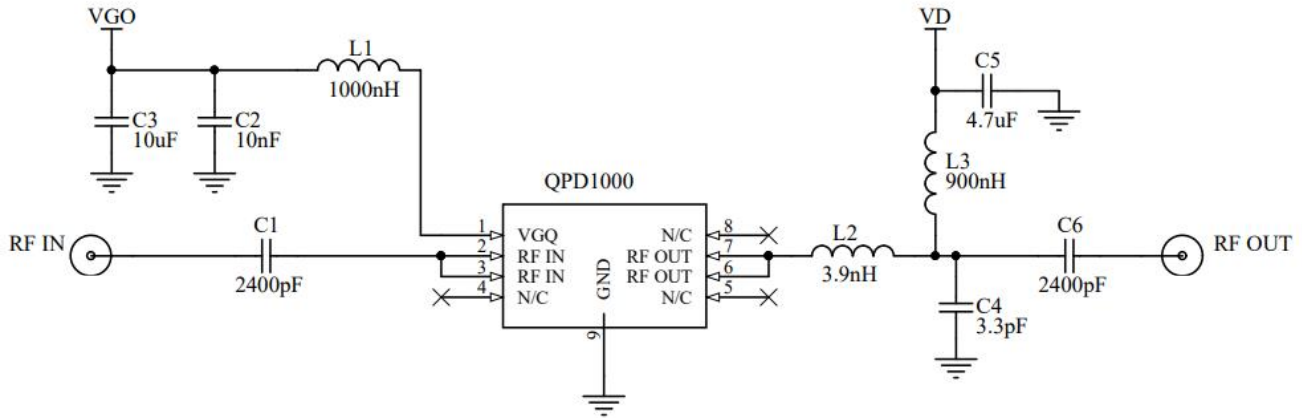

Bias-up Procedure	Bias-down Procedure
2. Set V_G to -4 V.	3. Turn off RF signal.
4. Set I_D current limit to 60 mA.	4. Turn off V_D
5. Apply 28 V V_D .	5. Wait 2 seconds to allow drain capacitor to discharge
6. Slowly adjust V_G until I_D is set to 50 mA.	7. Turn off V_G
8. Set I_D current limit to 2 A	
9. Apply RF.	

0.05 – 1.00 GHz Reference Design

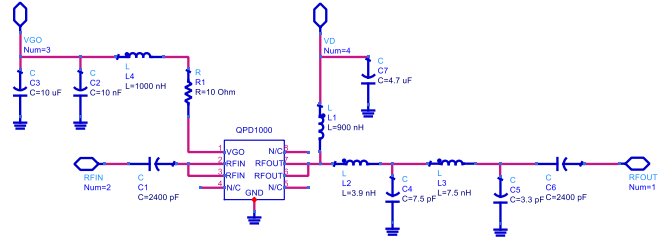
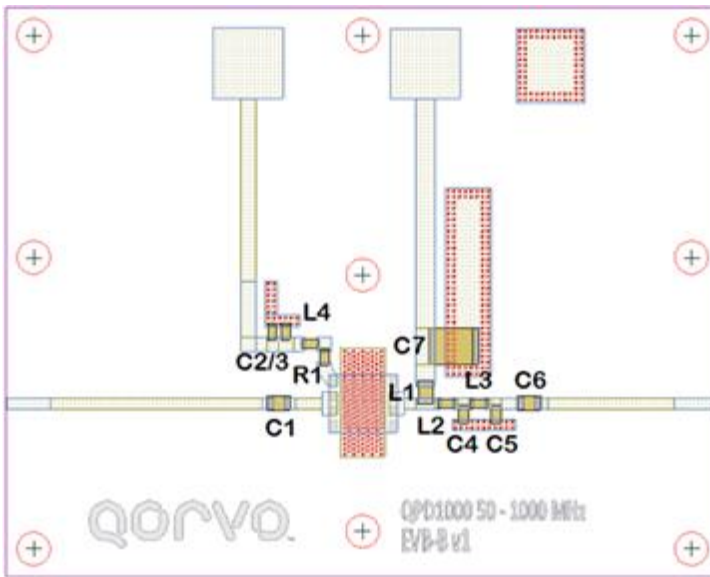

Notes:

1. PCB Material: RO4350B, 20 mil thickness, 1 oz copper cladding

Bill Of material - 0.05 – 1.00 GHz EVB

Ref Des	Value	Qty	Manufacturer	Part Number
R1	10 Ω	1	Vishay	CRCW060310R0JNEA
C2	10 nF	1	AVX	0603YC103KAT2A
C3	10 uF	1	Murata	GRM21BR71A106KE51L
C4	7.5 pF	1	ATC	600S7R5BT250XT
C1, C6	2400 pF	2	Dielectric Labs	C08BL242X-5UN-X0T
C5	3.3 pF	1	ATC	600S3R3BT250XT
C7	4.7 uF	1	Murata	GRM55ER72A475KA01L
L1	900 nH	1	Coilcraft	1008AF-901XJLC
L2	3.9 nH	1	Coilcraft	0603HC-3N9XGLW
L3	7.5 nH	1	Coilcraft	0603HC-7N5XGLW
L4	1000 nH	1	Coilcraft	0603LS-102XGLC

0.20 – 1.20 GHz Reference Design

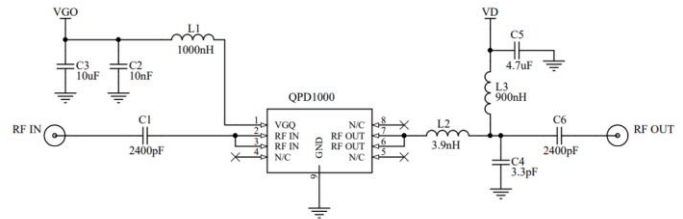
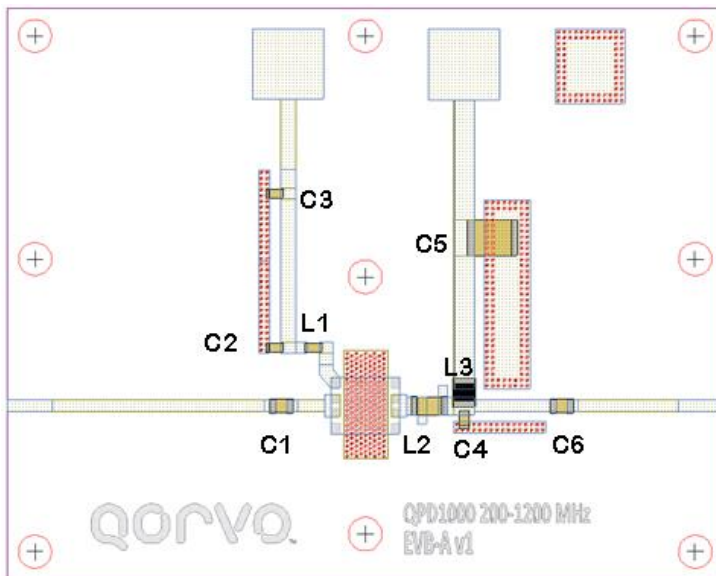

Notes:

1. PCB Material: RO4350B, 20 mil thickness, 1 oz copper cladding

Bill Of material - 0.2 – 1.20 GHz EVB

Ref Des	Value	Qty	Manufacturer	Part Number
C2	10 nF	1	AVX	0603YC103KAT2A
C3	10 uF	1	Murata	GRM21BR71A106KE51L
C4	3.3 pF	1	ATC	600S3R3AT250XT
C1, C6	2400 pF	2	Dielectric Labs	C08BL242X-5UN-X0T
C5	4.7 uF	1	Murata	GRM55ER72A475KA01L
L2	3.9 nH	1	Coilcraft	0603HC-3N9XGLW
L3	900 nH	1	Coilcraft	1008AF-901XJLC
L1	1000 nH	1	Coilcraft	0603LS-102XGLC

Tape and Reel Information

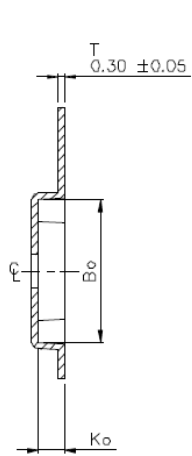

SECTION Y-Y

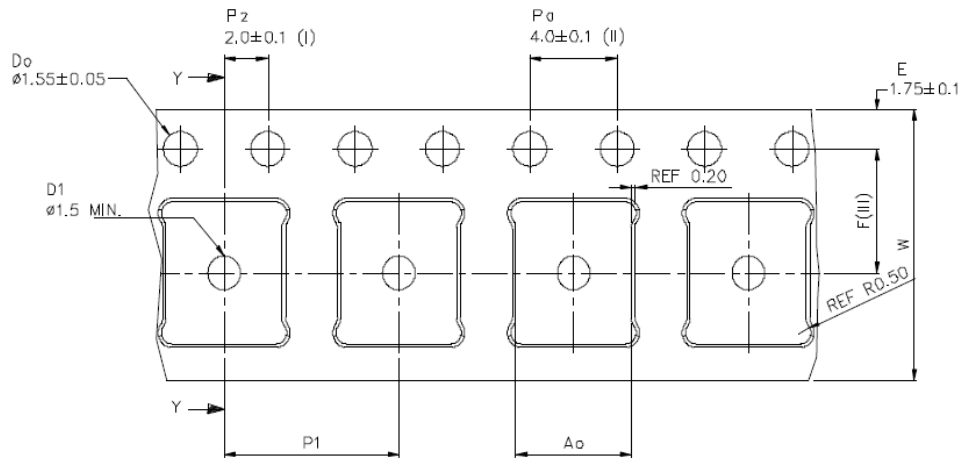

A ₀	5.30 +/− 0.1
B ₀	6.30 +/− 0.1
K ₀	1.20 +/− 0.1
F	5.50 +/− 0.1
P ₁	8.00 +/− 0.1
W	12.00 +/− 0.3

- (I) Measured from centreline of sprocket hole to centreline of pocket.
- (II) Cumulative tolerance of 10 sprocket holes is ± 0.20 .
- (III) Measured from centreline of sprocket hole to centreline of pocket.
- (IV) Other material available.

ALL DIMENSIONS IN MILLIMETRES UNLESS OTHERWISE STATED.

Recommended Solder Temperature Profile

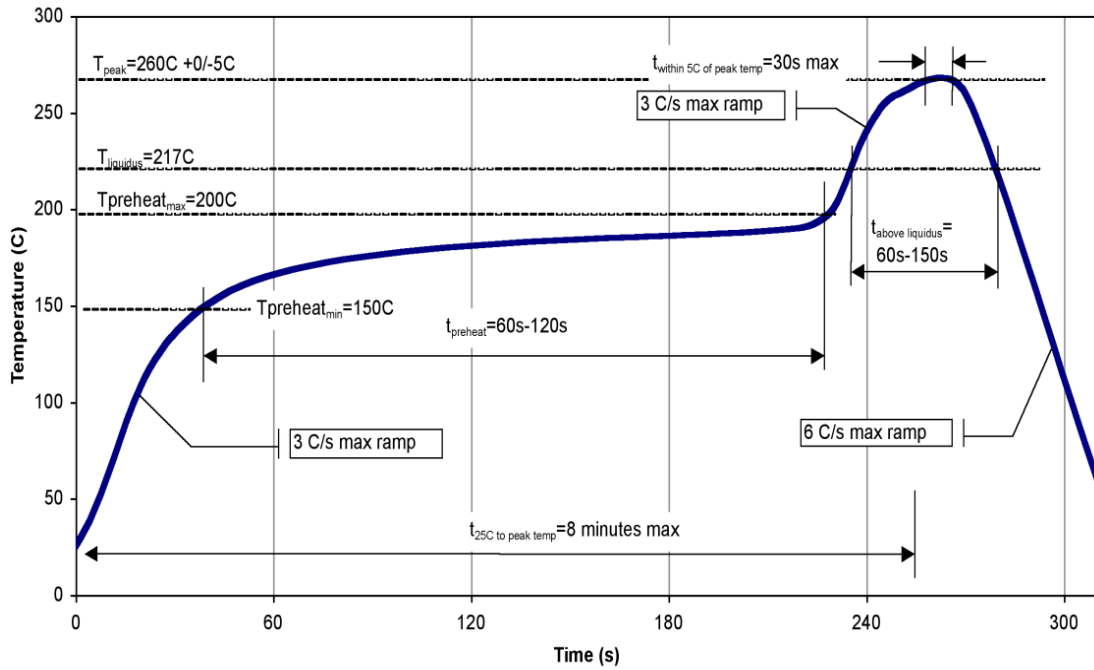

Handling Precautions

Parameter	Rating	Standard
ESD – Human Body Model (HBM)	Class 1A, 250 V	ANSI/ESD/JEDEC JS-001
ESD – Charged Device Model (CDM)	Class C2B, 750 V	ANSI/ESD/JEDEC JS-002
MSL – Moisture Sensitivity Level	MSL3	JESD J-STD-020



Caution!
ESD-Sensitive Device

Solderability

Compatible with both lead-free (260°C max. reflow temp.) and tin/lead (245°C max. reflow temp.) soldering processes. Solder profiles available upon request.

Contact plating: NiPdAu

RoHS Compliance

This part is compliant with 2011/65/EU RoHS directive (Restrictions on the Use of Certain Hazardous Substances in Electrical and Electronic Equipment) as amended by Directive 2015/863/EU.

This product also has the following attributes:

- Lead Free
- Halogen Free (Chlorine, Bromine)
- Antimony Free
- TBBP-A (C₁₅H₁₂Br₄O₂) Free
- PFOS Free
- SVHC Free



Contact Information

For the latest specifications, additional product information, worldwide sales and distribution locations, and information about Qorvo:

Web: www.qorvo.com Tel: +1.844.890.8163
 Email: customer.support@qorvo.com

Important Notice

The information contained herein is believed to be reliable; however, Qorvo makes no warranties regarding the information contained herein and assumes no responsibility or liability whatsoever for the use of the information contained herein. All information contained herein is subject to change without notice. Customers should obtain and verify the latest relevant information before placing orders for Qorvo products. The information contained herein or any use of such information does not grant, explicitly or implicitly, to any party any patent rights, licenses, or any other intellectual property rights, whether with regard to such information itself or anything described by such information. **THIS INFORMATION DOES NOT CONSTITUTE A WARRANTY WITH RESPECT TO THE PRODUCTS DESCRIBED HEREIN, AND QORVO HEREBY DISCLAIMS ANY AND ALL WARRANTIES WITH RESPECT TO SUCH PRODUCTS WHETHER EXPRESS OR IMPLIED BY LAW, COURSE OF DEALING, COURSE OF PERFORMANCE, USAGE OF TRADE OR OTHERWISE, INCLUDING THE IMPLIED WARRANTIES OF MERCHANTABILITY AND FITNESS FOR A PARTICULAR PURPOSE.**

Without limiting the generality of the foregoing, Qorvo products are not warranted or authorized for use as critical components in medical, life-saving, or life-sustaining applications, or other applications where a failure would reasonably be expected to cause severe personal injury or death.

Copyright 2021 © Qorvo, Inc. | Qorvo is a registered trademark of Qorvo, Inc.

X-ON Electronics

Largest Supplier of Electrical and Electronic Components

Click to view similar products for [RF JFET Transistors](#) category:

Click to view products by [Qorvo](#) manufacturer:

Other Similar products are found below :

[CE3514M4](#) [CE3514M4-C2](#) [CE3520K3-C1](#) [CE3521M4](#) [CE3521M4-C2](#) [CE3512K2-C1](#) [CE3520K3](#) [CG2H80030D-GP4](#) [TGF2023-2-02](#)
[NPT1004D](#) [MAGX-011086](#) [NPT25015D](#) [JANTXV2N4858](#) [MMBFJ211](#) [NPT2021](#) [NPTB00025B](#) [2SK3557-6-TB-E](#) [J211_D74Z](#)
[NPTB00004A](#) [QPD0020](#) [QPD1006](#) [QPD1016](#) [QPD1025L](#) [QPD1029L](#) [QPD1881L](#) [T2G6001528-Q3](#) [SKY65050-372LF](#) [TGF2965-SM](#)
[QPD1009](#) [QPD1010](#) [J304](#) [CGH27015F](#) [CGH55015F1](#) [CMPA801B030F](#) [GTVA262711FA-V2-R0](#) [GTVA262701FA-V2-R0](#) [CGH40006S](#)
[CGH40010F](#) [CGH40025F](#) [CGH40035F](#) [CGH40045F](#) [CGH40120F](#) [CGH55015F2](#) [CGH60008D](#) [CGH60030D](#) [CGHV14500F](#) [CGHV1F006S](#)
[CGHV1J006D](#) [CGHV27030S](#) [CGHV27060MP](#)