

### Product Overview

The QPD1006 is a 450 W ( $P_{3dB}$ ) internally matched discrete GaN on SiC HEMT which operates from 1.2 to 1.4 GHz and a 50V supply rail. The device is GaN IMFET fully matched to 50  $\Omega$  in an industry standard air cavity package and is ideally suited for military and civilian radar. The device can support pulsed and CW operations.

ROHS compliant.

Evaluation boards are available upon request.

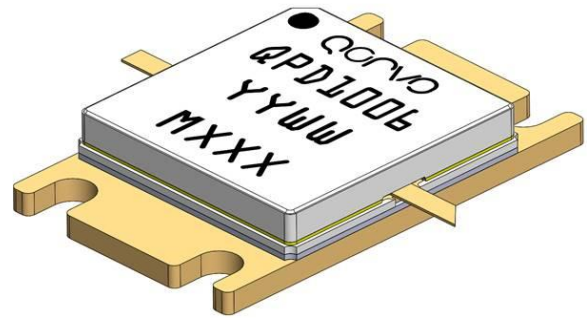

NI-50CW

### Functional Block Diagram

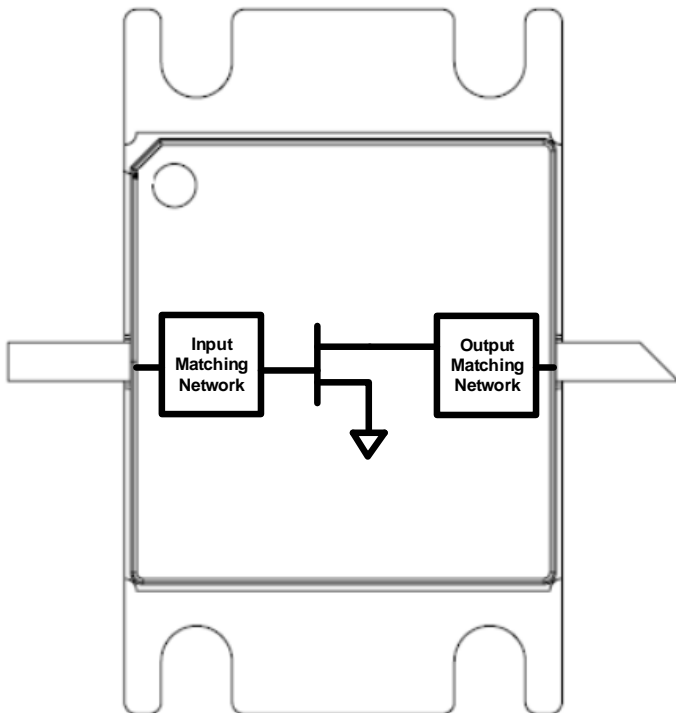

### Key Features

- Frequency: 1.2 to 1.4 GHz
  - Output Power ( $P_{3dB}$ )<sup>1</sup>: 313 W (CW), 468 W (Pulsed)
  - Linear Gain<sup>1</sup>: 17.5 dB (CW), 17.8 dB (Pulsed)
  - Typical  $DEFF_{3dB}$ <sup>1</sup>: 55% (CW), 62.2% (Pulsed)
  - Operating Voltage: 45 V (CW), 50 V (Pulsed)
  - Low thermal resistance package
  - Pulse capable
- Note 1: @ 1.3 GHz, 25 °C

### Applications

- Military radar
- Civilian radar

Part No.	Description
QPD1006	1.2 – 1.4 GHz RF IMFET
QPD1006EVB4	Evaluation Board

### Absolute Maximum Ratings<sup>1</sup>

Parameter	Rating	Units
Breakdown Voltage, $BV_{DG}$	+145	V
Gate Voltage Range, $V_G$	-7 to +2	V
Drain Current	60	A
Gate Current Range, $I_G$	See page 4.	mA
Power Dissipation, 10% DC 1 mS PW, $P_{DISS}$	496	W
RF Input Power, 10% DC 1 mS PW, 1.3 GHz, $T = 25\text{ }^\circ\text{C}$	+46	dBm
Mounting Temperature (30 Seconds)	320	$^\circ\text{C}$
Storage Temperature	-65 to +150	$^\circ\text{C}$

Notes:

1. Operation of this device outside the parameter ranges given above may cause permanent damage.

### Recommended Operating Conditions<sup>1</sup>

Parameter	Min	Typ	Max	Units
Operating Temp. Range	-40	+25	+85	$^\circ\text{C}$
Drain Voltage Range, $V_D$	+28	+50	+55	V
Drain Bias Current, $I_{DQ}$	-	750	-	mA
Drain Current, $I_D$	-	14	-	A
Gate Voltage, $V_G^4$	-	-2.7	-	V
Power Dissipation, Pulsed ( $P_D$ ) <sup>2, 3</sup>	-	-	445	W
Power Dissipation, CW ( $P_D$ ) <sup>2</sup>	-	-	299	W

Notes:

1. Electrical performance is measured under conditions noted in the electrical specifications table. Specifications are not guaranteed over all recommended operating conditions.
2. Package base at 85  $^\circ\text{C}$ .
3. Pulse Width = 300  $\mu\text{s}$ , Duty Cycle = 30%.
4. To be adjusted to desired  $I_{DQ}$ .

### RF Characterization – EVB CW Performance At 1.2 GHz<sup>1</sup>

Parameter	Min	Typ	Max	Units
Linear Gain, $G_{LIN}$	-	17.5	-	dB
Output Power at 3dB compression point, $P_{3dB}$	-	55.4	-	dBm
Drain Efficiency at 3dB compression point, $DEFF_{3dB}$	-	56.2	-	%
Gain at 3dB compression point, $G_{3dB}$	-	14.5	-	dB

Notes:

1.  $V_D = +45\text{ V}$ ,  $I_{DQ} = 750\text{ mA}$ ,  $T_A = 25\text{ }^\circ\text{C}$

### RF Characterization – EVB CW Performance At 1.3 GHz<sup>1</sup>

Parameter	Min	Typ	Max	Units
Linear Gain, $G_{LIN}$	-	17.3	-	dB
Output Power at 3dB compression point, $P_{3dB}$	-	54.9	-	dBm
Drain Efficiency at 3dB compression point, $DEFF_{3dB}$	-	54.6	-	%
Gain at 3dB compression point, $G_{3dB}$	-	14.3	-	dB

Notes:

1.  $V_D = +45\text{ V}$ ,  $I_{DQ} = 750\text{ mA}$ ,  $T_A = 25\text{ }^\circ\text{C}$

### RF Characterization – EVB CW Performance At 1.4 GHz<sup>1</sup>

Parameter	Min	Typ	Max	Units
Linear Gain, $G_{LIN}$	-	17.5	-	dB
Output Power at 3dB compression point, $P_{3dB}$	-	54.7	-	dBm
Drain Efficiency at 3dB compression point, $DEFF_{3dB}$	-	49.4	-	%
Gain at 3dB compression point, $G_{3dB}$	-	14.5	-	dB

Notes:

1.  $V_D = +45\text{ V}$ ,  $I_{DQ} = 750\text{ mA}$ ,  $T_A = 25\text{ }^\circ\text{C}$

### RF Characterization – EVB Pulsed Performance At 1.2 GHz<sup>1</sup>

Parameter	Min	Typ	Max	Units
Linear Gain, $G_{LIN}$	–	17.8	–	dB
Output Power at 3dB compression point, $P_{3dB}$	–	57.1	–	dBm
Drain Efficiency at 3dB compression point, $DEFF_{3dB}$	–	62.8	–	%
Gain at 3dB compression point, $G_{3dB}$	–	14.8	–	dB

Notes:

- $V_D = +50\text{ V}$ ,  $I_{DQ} = 750\text{ mA}$ ,  $T_A = +25\text{ °C}$ ,  $PW = 300\text{ uS}$ ,  $DC = 30\%$

### RF Characterization – EVB Pulsed Performance At 1.3 GHz<sup>1</sup>

Parameter	Min	Typ	Max	Units
Linear Gain, $G_{LIN}$	–	17.8	–	dB
Output Power at 3dB compression point, $P_{3dB}$	–	56.7	–	dBm
Drain Efficiency at 3dB compression point, $DEFF_{3dB}$	–	62.0	–	%
Gain at 3dB compression point, $G_{3dB}$	–	14.8	–	dB

Notes:

- $V_D = +50\text{ V}$ ,  $I_{DQ} = 750\text{ mA}$ ,  $T_A = +25\text{ °C}$ ,  $PW = 300\text{ uS}$ ,  $DC = 30\%$

### RF Characterization – EVB Pulsed Performance At 1.4 GHz<sup>1</sup>

Parameter	Min	Typ	Max	Units
Linear Gain, $G_{LIN}$	–	17.8	–	dB
Output Power at 3dB compression point, $P_{3dB}$	–	57.1	–	dBm
Drain Efficiency at 3dB compression point, $DEFF_{3dB}$	–	59.6	–	%
Gain at 3dB compression point, $G_{3dB}$	–	14.8	–	dB

Notes:

- $V_D = +50\text{ V}$ ,  $I_{DQ} = 750\text{ mA}$ ,  $T_A = +25\text{ °C}$ ,  $PW = 300\text{ uS}$ ,  $DC = 30\%$

### RF Characterization – Mismatch Ruggedness at 1.3 GHz<sup>1</sup>

Symbol	Parameter	dB Compression	Typical
VSWR	Impedance Mismatch Ruggedness	3	10:1

Notes:

- Test conditions unless otherwise noted:  $T_A = 25\text{ °C}$ ,  $V_D = 50\text{ V}$ ,  $I_{DQ} = 750\text{ mA}$ ,  $100\text{ uS PW}$ ,  $10\% DC$
- Driving input power is determined at pulsed compression under matched condition at EVB output connector.

Maximum Gate Current

Maximum Gate Current Vs. IR Surface Temperature

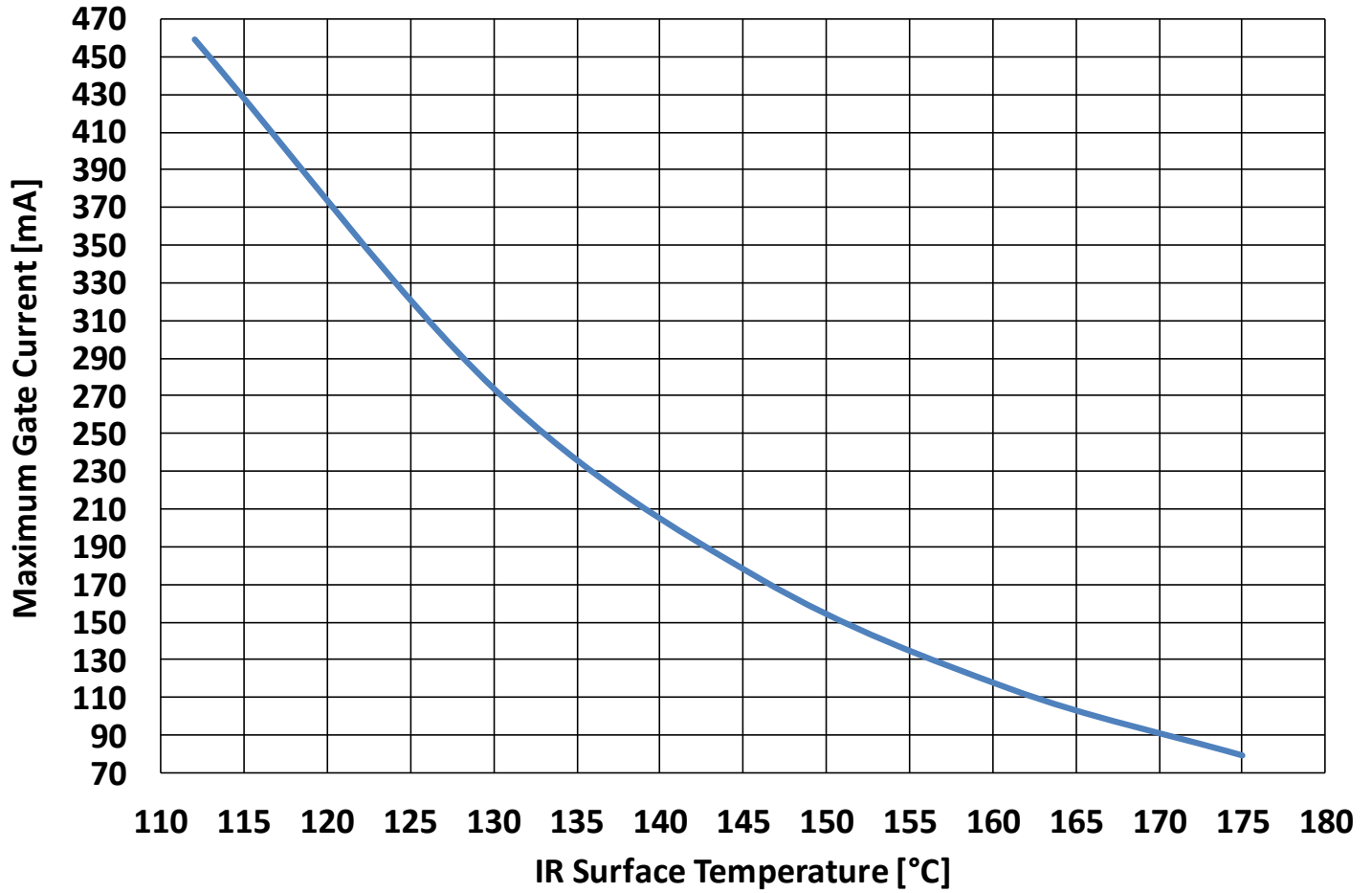

Thermal and Reliability Information – Pulsed

Maximum IR Surface Temperature vs. Pulse Width  
Back Base Fixed at 85 °C, Pdiss = 331 W

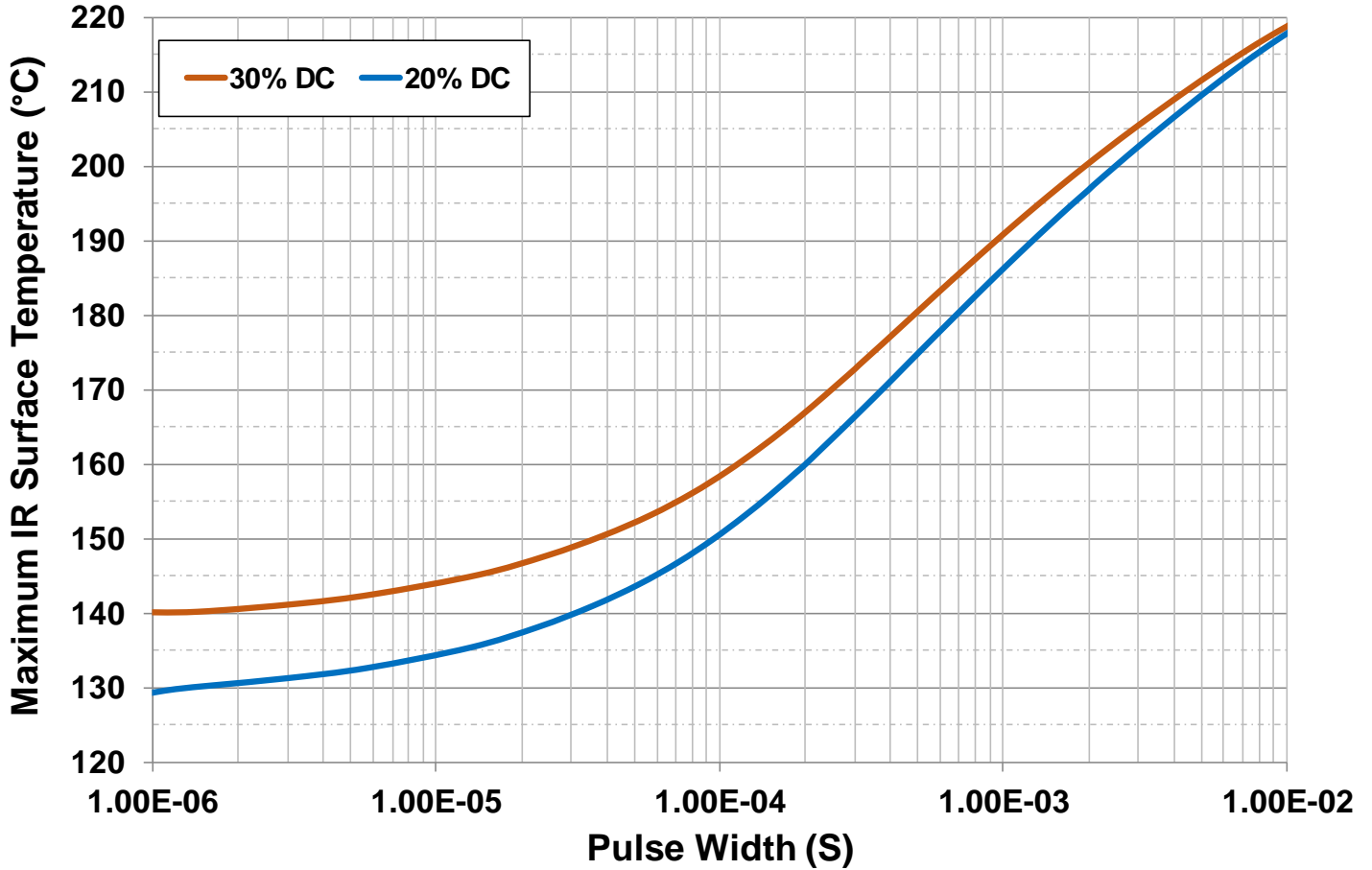

Parameter	Conditions	Values	Units
Thermal Resistance, IR <sup>1</sup> ( $\theta_{JC}$ )	85 °C back side temperature	0.23	°C/W
Peak IR Surface Temperature <sup>1</sup> ( $T_{CH}$ )	331 W Pdiss, 200 uS PW, 20% DC	160	°C
Thermal Resistance, IR <sup>1</sup> ( $\theta_{JC}$ )	85 °C back side temperature	0.27	°C/W
Peak IR Surface Temperature <sup>1</sup> ( $T_{CH}$ )	331 W Pdiss, 300 uS PW, 30% DC	173	°C

<sup>1</sup> Refer to the following document [GaN Device Channel Temperature, Thermal Resistance, and Reliability Estimates](#)

**Thermal and Reliability Information – CW**

**Maximum IR Surface Temperature vs. Power Dissipation  
Back Surface of Package Fixed at 85 °C**

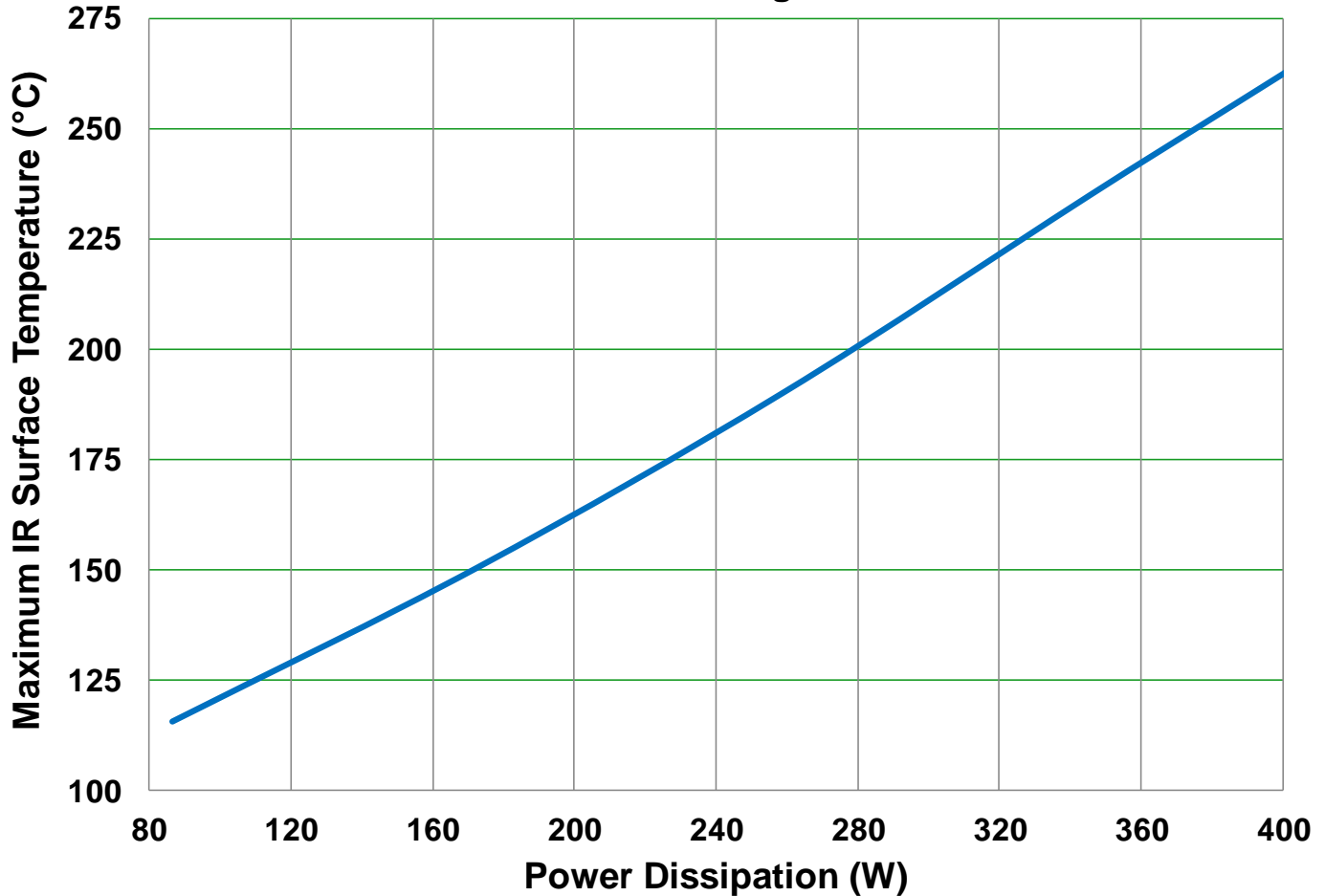

Parameter	Conditions	Values	Units
Thermal Resistance, IR <sup>1</sup> ( $\theta_{JC}$ )	85 °C back side temperature	0.35	°C/W
Peak IR Surface Temperature <sup>1</sup> ( $T_{CH}$ )	86.4 W Pdiss, CW	116	°C
Thermal Resistance, IR <sup>1</sup> ( $\theta_{JC}$ )	85 °C back side temperature	0.38	°C/W
Peak IR Surface Temperature <sup>1</sup> ( $T_{CH}$ )	177.8 W Pdiss, CW	151	°C
Thermal Resistance, IR <sup>1</sup> ( $\theta_{JC}$ )	85 °C back side temperature	0.41	°C/W
Peak IR Surface Temperature <sup>1</sup> ( $T_{CH}$ )	259.2 W Pdiss, CW	190	°C
Thermal Resistance, IR <sup>1</sup> ( $\theta_{JC}$ )	85 °C back side temperature	0.43	°C/W
Peak IR Surface Temperature <sup>1</sup> ( $T_{CH}$ )	345.6 W Pdiss, CW	235	°C

<sup>1</sup> Refer to the following document [GaN Device Channel Temperature, Thermal Resistance, and Reliability Estimates](#)

**CW Power Drive-up Performance Over Temperatures Of 1.2 – 1.4 GHz EVB<sup>1</sup>**

Notes:

1.  $V_D = 45\text{ V}$ ,  $I_{DQ} = 750\text{ mA}$ .

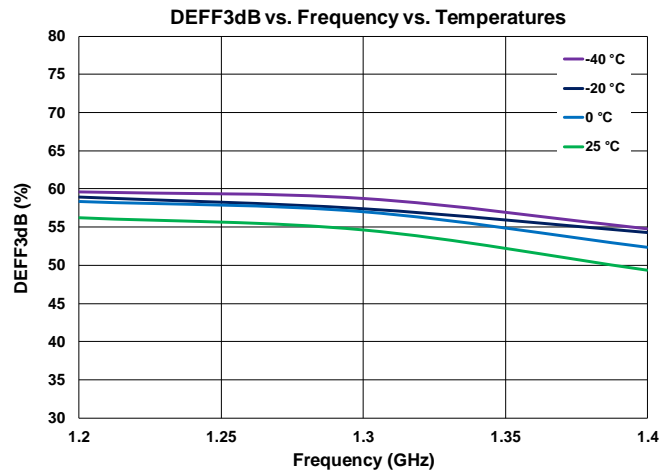
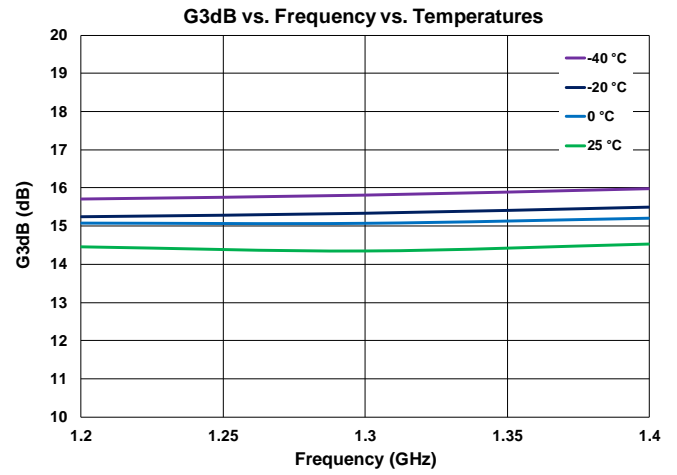
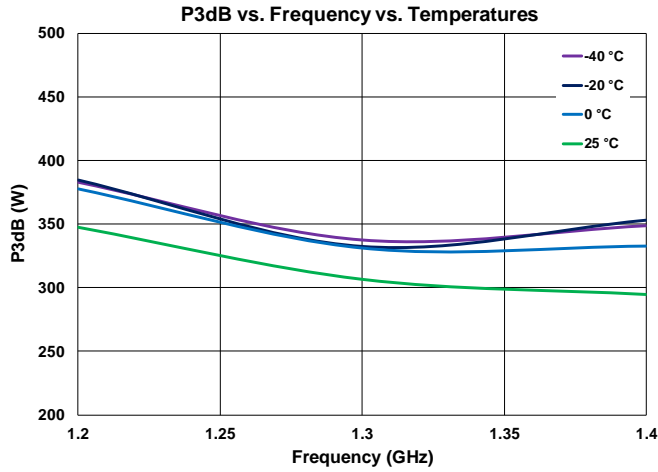

**CW Power Drive-up Performance At 25 °C Of 1.2 – 1.4 GHz EVB<sup>1</sup>**

Notes:

- $V_D = 45\text{ V}$ ,  $I_{DQ} = 750\text{ mA}$ .

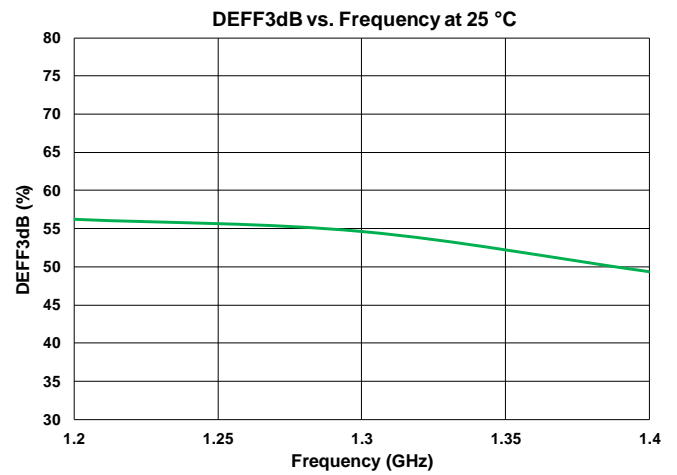
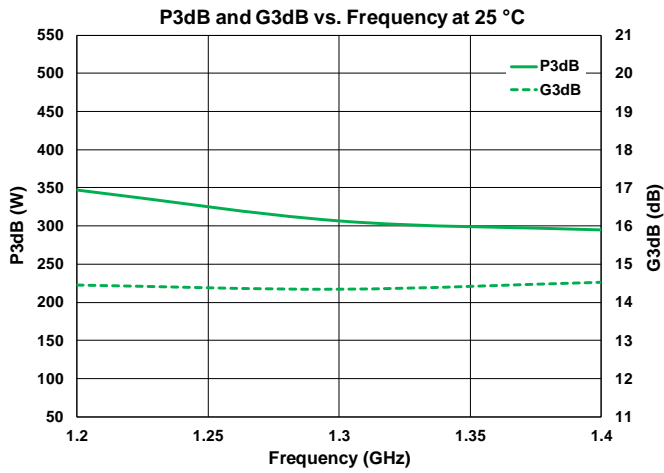



### Pulsed Power Drive-up Performance Over Temperatures Of 1.2 – 1.4 GHz EVB<sup>1</sup>

Notes:

- $V_D = 50\text{ V}$ ,  $I_{DQ} = 750\text{ mA}$ ,  $PW = 300\text{ uS}$ ,  $DC = 30\%$ .

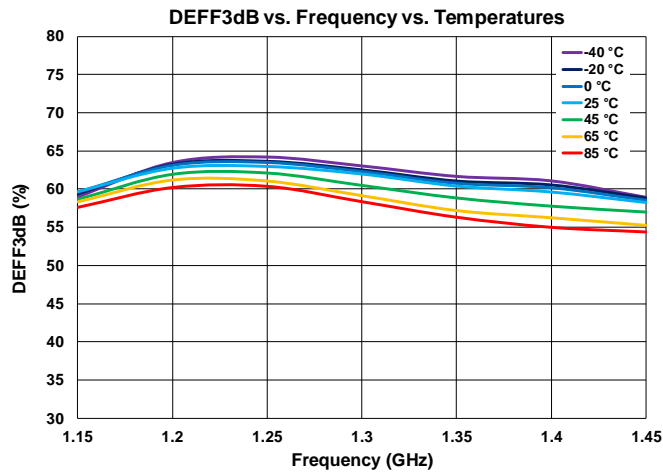
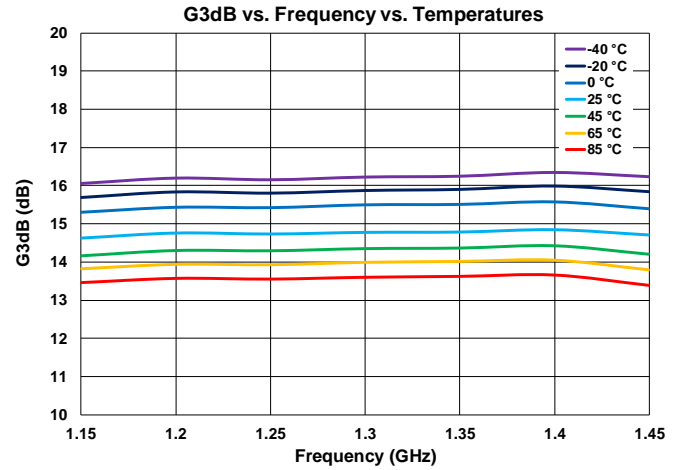
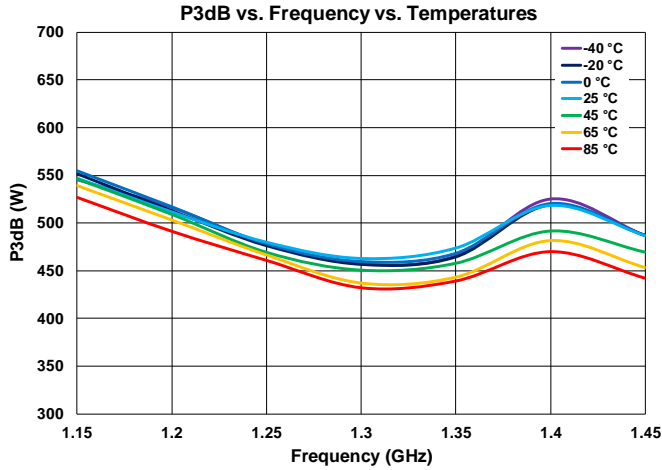

**Power Drive-up Performance At 25 °C Of 1.2 – 1.4 GHz EVB<sup>1</sup>**

Notes:

1.  $V_D = 50\text{ V}$ ,  $I_{DQ} = 750\text{ mA}$ ,  $PW = 300\text{ }\mu\text{s}$ ,  $DC = 30\%$ .

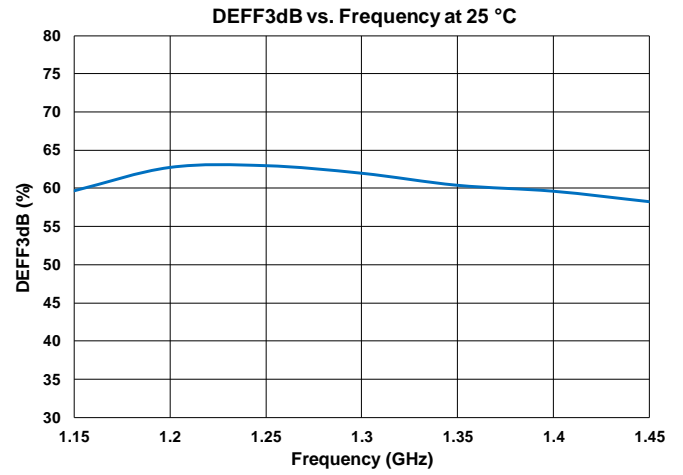
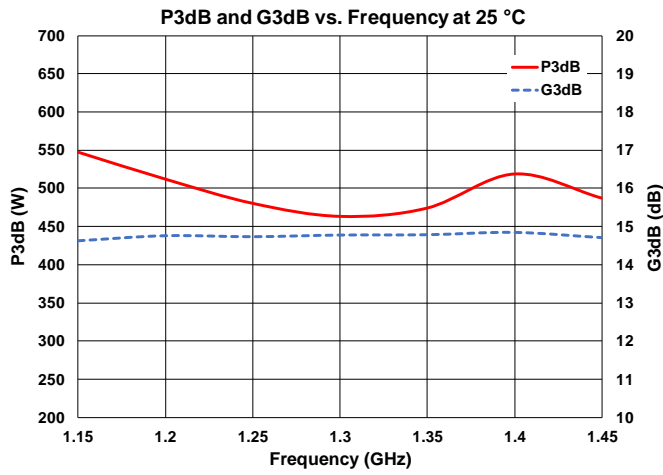

**Pin Configuration and Description, and Package Marking<sup>1</sup>**

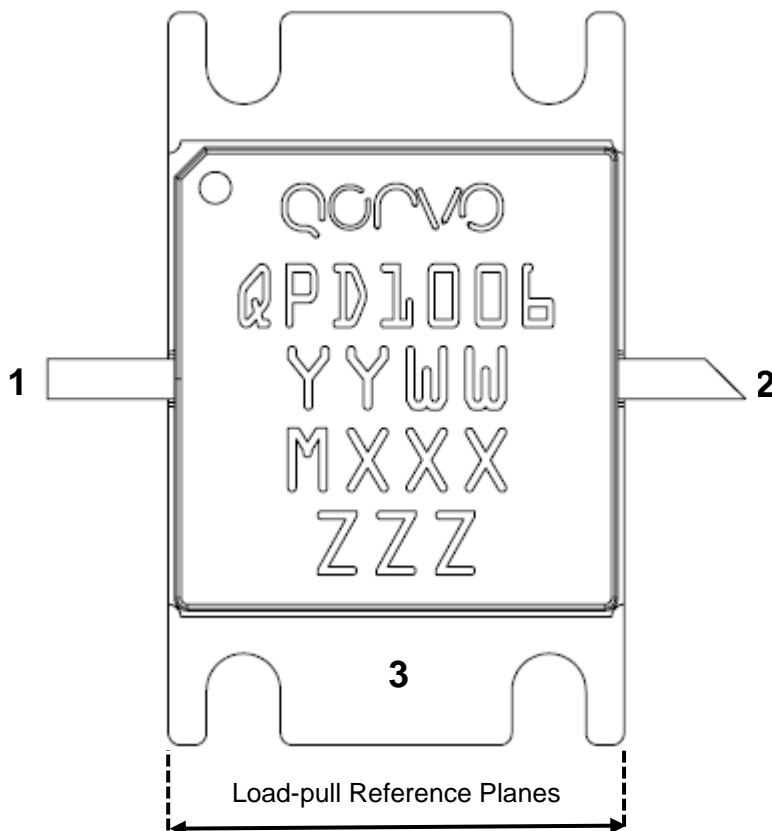

**Notes:**

1. The QPD1006 will be marked with the “1006” designator and a lot code marked below the part designator. The “YY” represents the last two digits of the calendar year the part was manufactured, the “WW” is the work week of the assembly lot start, the “MXXX” is the production lot number. “ZZZ” is the unique serial number.

**Pin Description**

Pin	Symbol	Description
1	$V_G$ / RF IN	Gate voltage / RF Input
2	$V_D$ / RF OUT	Drain voltage / RF Output
3	GND	Package base / Ground

**Package Dimensions<sup>1, 2, 3</sup>**

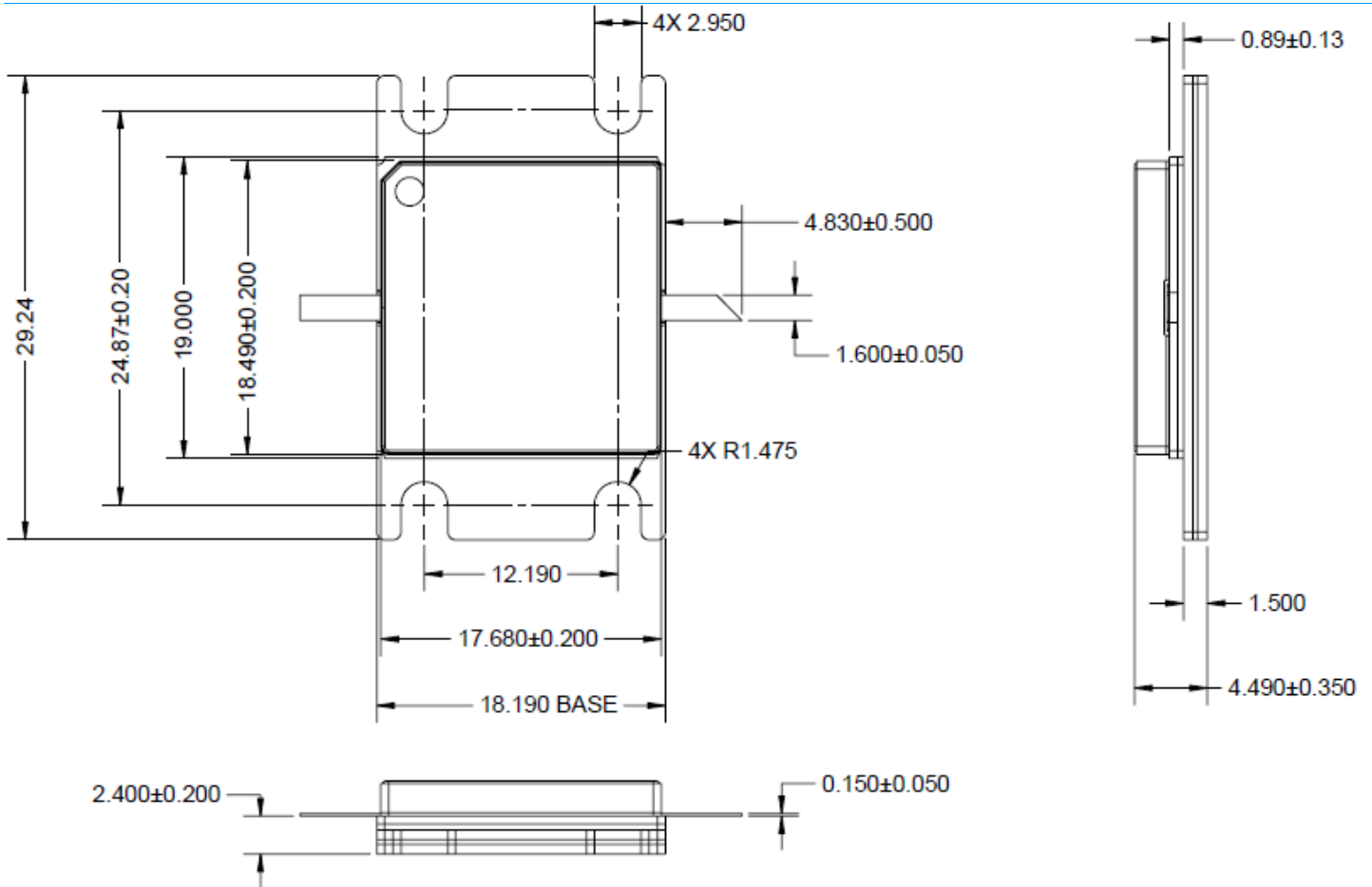

**Notes:**

1. Unless otherwise noted, the tolerance is  $\pm 0.15$  mm.
2. For instruction to mount the part, please refer to application note "[RF565 Package Mounting, Mechanical Mounting and PCB Considerations.](#)"
3. Material:
  - Package Base: Metal
  - Package Lid: Ceramic
4. Package exposed metallization is gold plated.
5. Part is epoxy sealed.
6. Body dimensions do not include lid shift or epoxy run out which can be up to 0.5 mm per side.

**Schematic – 1.2 – 1.4 GHz EVB**

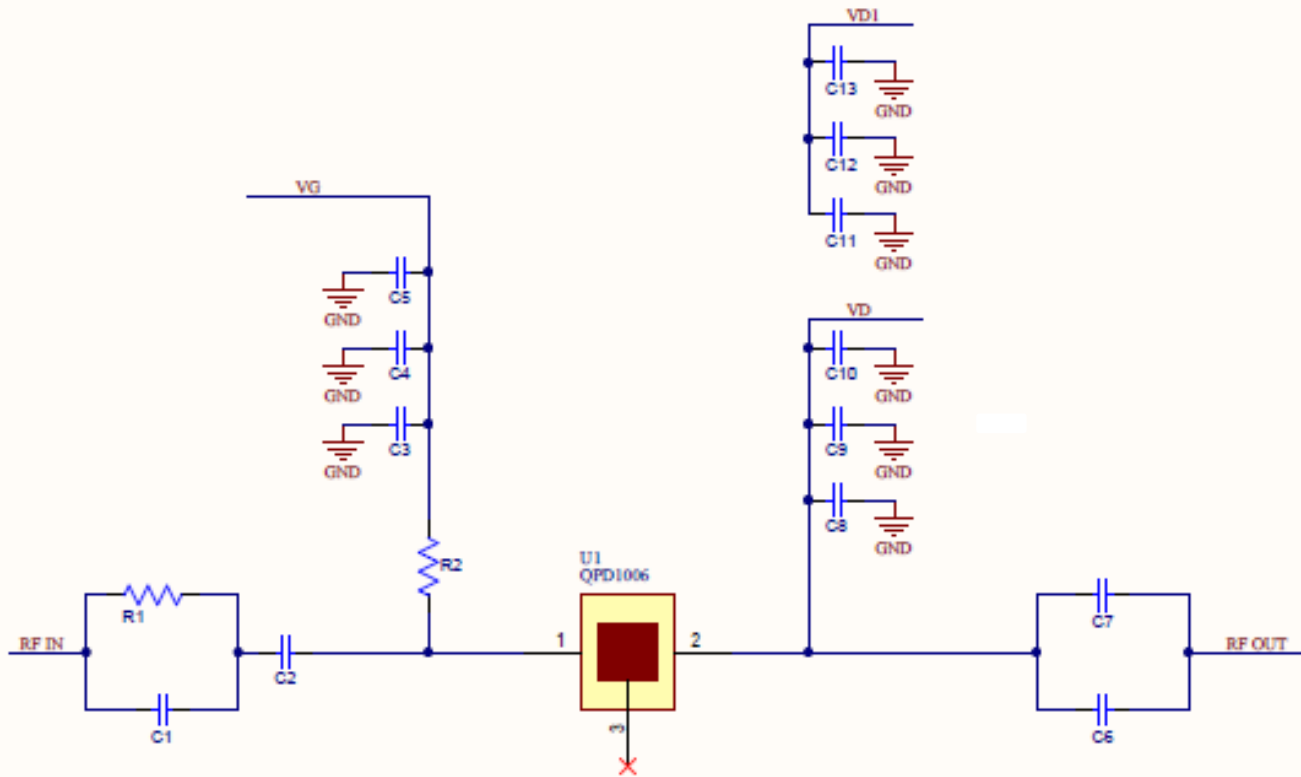

Bias-up Procedure	Bias-down Procedure
1. Set $V_G$ to -4 V.	1. Turn off RF signal.
2. Set $I_D$ current limit to 800 mA.	2. Turn off $V_D$
3. Apply 50 V $V_D$ .	3. Wait 2 seconds to allow drain capacitor to discharge
4. Slowly adjust $V_G$ until $I_D$ is set to 750 mA.	4. Turn off $V_G$
5. Set $I_D$ current limit to 7 A	
6. Apply RF.	

### 1.2 – 1.4 GHz EVB <sup>1,2</sup>

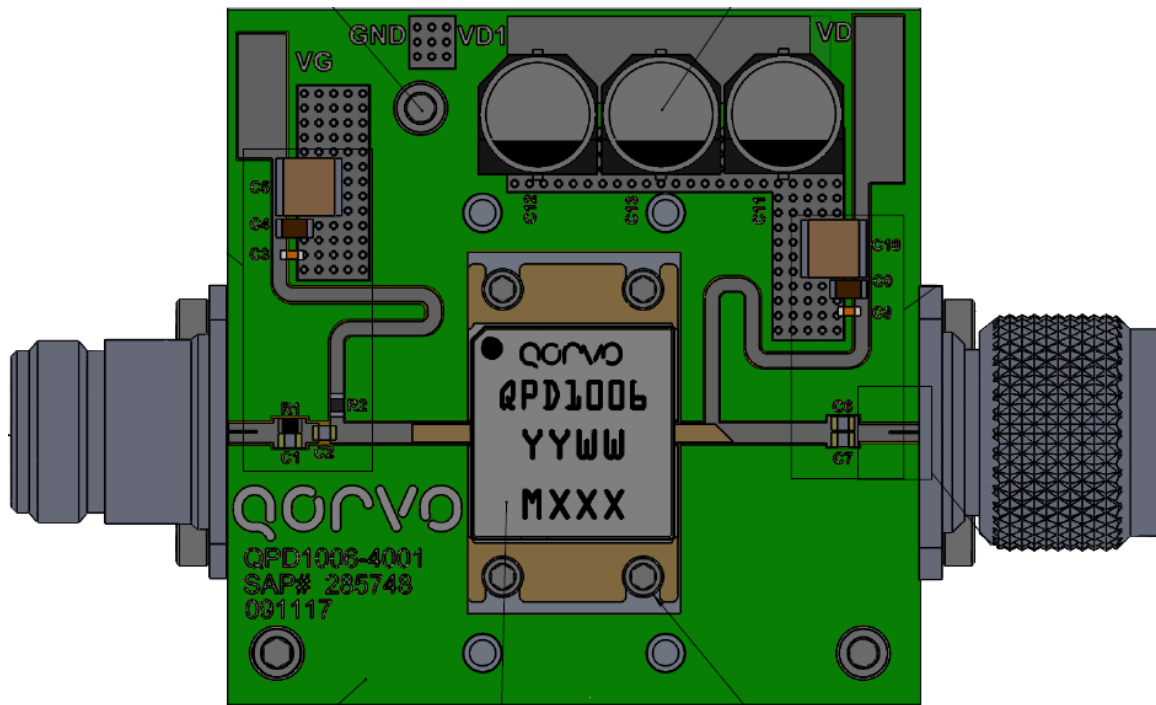

**Notes:**

1. PCB Material: RO4350B, 20 mil thickness, 1 oz copper cladding
2. For good pulsed operation, an additional 3300 uF, 100 V electrolytic capacitor is required on the drain supply line.

### Bill Of material – 1.2 – 1.4 GHz Pulsed or CW EVB

Ref Des	Value	Qty	Manufacturer	Part Number
C1, C2, C6, C7	33 pF	4	ATC	600F330JT250XT
C4, C9	0.1 uF	2	TDK	C3216X7R2A104K160AA
C3, C8	240 pF	2	AVX	UQCFVA241JAT2A\500
C11, C12, C13	220 uF	3	United Chemicon	EMVY500ADA221MJA03
C5, C10	10 uF	2	TDK	C5750X7S2A106M230KB
R1	100 Ohm	1	Kamaya, Inc	RMC1/10-101JTP
R2	10 Ohm	1	Vishay	CRCW080510R0JNTA

Recommended Solder Temperature Profile

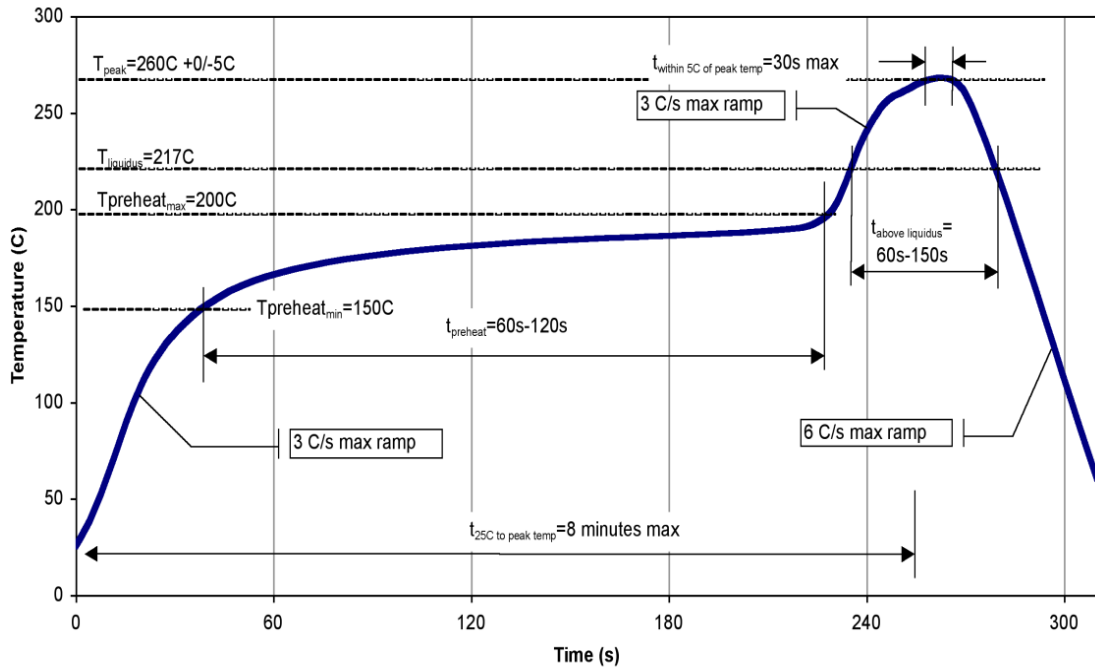

## Handling Precautions

Parameter	Rating	Standard
ESD – Human Body Model (HBM)	1000 V	ANSI/ESD/JEDEC JS-001
ESD – Charged Device Model (CDM)	1000 V	ANSI/ESD/JEDEC JS-002
MSL – Moisture Sensitivity Level	MSL3	IPC/JEDEC J-STD-020



Caution!  
ESD-Sensitive Device

## Solderability

Compatible with both lead-free (260°C max. reflow temp.) and tin/lead (245°C max. reflow temp.) soldering processes. Solder profiles available upon request.

Package lead plating is NiAu. Au thickness is 1 µm minimum.

## RoHS Compliance

This part is compliant with 2011/65/EU RoHS directive (Restrictions on the Use of Certain Hazardous Substances in Electrical and Electronic Equipment) as amended by Directive 2015/863/EU.

This product also has the following attributes:

- Halogen Free (Chlorine, Bromine)
- Antimony Free
- TBBP-A (C<sub>15</sub>H<sub>12</sub>Br<sub>4</sub>O<sub>2</sub>) Free
- PFOS Free
- SVHC Free

## Contact Information

For the latest specifications, additional product information, worldwide sales and distribution locations:

**Web:** [www.qorvo.com](http://www.qorvo.com)

**Tel:** 1-844-890-8163

**Email:** [customer.support@qorvo.com](mailto:customer.support@qorvo.com)

## Important Notice

The information contained herein is believed to be reliable; however, Qorvo makes no warranties regarding the information contained herein and assumes no responsibility or liability whatsoever for the use of the information contained herein. All information contained herein is subject to change without notice. Customers should obtain and verify the latest relevant information before placing orders for Qorvo products. The information contained herein or any use of such information does not grant, explicitly or implicitly, to any party any patent rights, licenses, or any other intellectual property rights, whether with regard to such information itself or anything described by such information. **THIS INFORMATION DOES NOT CONSTITUTE A WARRANTY WITH RESPECT TO THE PRODUCTS DESCRIBED HEREIN, AND QORVO HEREBY DISCLAIMS ANY AND ALL WARRANTIES WITH RESPECT TO SUCH PRODUCTS WHETHER EXPRESS OR IMPLIED BY LAW, COURSE OF DEALING, COURSE OF PERFORMANCE, USAGE OF TRADE OR OTHERWISE, INCLUDING THE IMPLIED WARRANTIES OF MERCHANTABILITY AND FITNESS FOR A PARTICULAR PURPOSE.**

Without limiting the generality of the foregoing, Qorvo products are not warranted or authorized for use as critical components in medical, life-saving, or life-sustaining applications, or other applications where a failure would reasonably be expected to cause severe personal injury or death.

Copyright 2020 © Qorvo, Inc. | Qorvo is a registered trademark of Qorvo, Inc.



## X-ON Electronics

Largest Supplier of Electrical and Electronic Components

*Click to view similar products for [RF Development Tools](#) category:*

*Click to view products by [Qorvo](#) manufacturer:*

Other Similar products are found below :

[MAAM-011117](#) [MAAP-015036-DIEEV2](#) [EV1HMC1113LP5](#) [EV1HMC6146BLC5A](#) [EV1HMC637ALP5](#) [EVAL-ADG919EBZ](#) [ADL5363-EVALZ](#) [LMV228SDEVAL](#) [SKYA21001-EVB](#) [SMP1331-085-EVB](#) [EV1HMC618ALP3](#) [EVAL01-HMC1041LC4](#) [MAAL-011111-000SMB](#)  
[MAAM-009633-001SMB](#) [MASW-000936-001SMB](#) [107712-HMC369LP3](#) [107780-HMC322ALP4](#) [SP000416870](#) [EV1HMC470ALP3](#)  
[EV1HMC520ALC4](#) [EV1HMC244AG16](#) [MAX2614EVKIT#](#) [124694-HMC742ALP5](#) [SC20ASATEA-8GB-STD](#) [MAX2837EVKIT+](#)  
[MAX2612EVKIT#](#) [MAX2692EVKIT#](#) [EV1HMC629ALP4E](#) [SKY12343-364LF-EVB](#) [108703-HMC452QS16G](#) [EV1HMC863ALC4](#)  
[EV1HMC427ALP3E](#) [119197-HMC658LP2](#) [EV1HMC647ALP6](#) [ADL5725-EVALZ](#) [MAX2371EVKIT#](#) [106815-HMC441LM1](#)  
[EV1HMC1018ALP4](#) [UXN14M9PE](#) [MAX2016EVKIT](#) [EV1HMC939ALP4](#) [MAX2410EVKIT](#) [MAX2204EVKIT+](#) [EV1HMC8073LP3D](#)  
[SIMSA868-DKL](#) [SIMSA868C-DKL](#) [SKY65806-636EK1](#) [SKY68020-11EK1](#) [SKY67159-396EK1](#) [SKY66181-11-EK1](#)