

General Description

The QPD1014 is a 15W (P_{3dB}), 50Ω-input matched discrete GaN on SiC HEMT which operates from 30MHz to 1200MHz on a 50V supply rail. The integrated input matching network enables wideband gain and power performance, while the output can be matched on board to optimize power and efficiency for any region within the band. It is ideally suited for basestation, radar and communications applications and can support both CW and pulsed mode of operations.

The device is housed in a 6 x 5 mm surface mount DFN package.

Functional Block Diagram

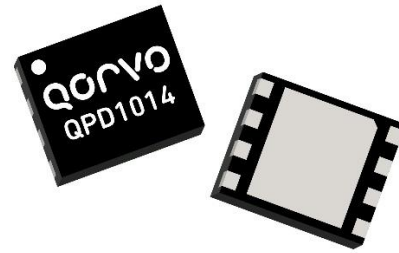
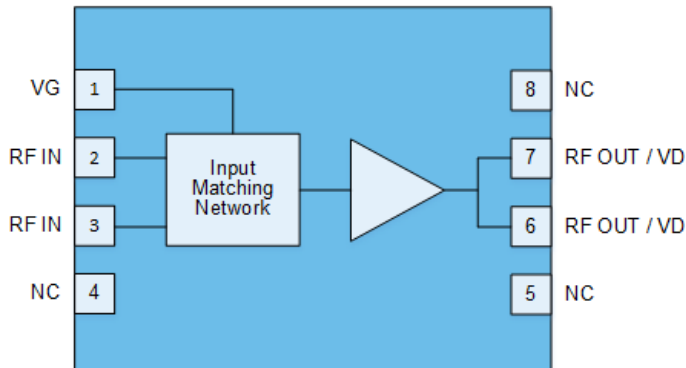

8 Pin DFN (6 x 5 x 0.85 mm)

Product Features

- Frequency: 30 to 1200 MHz
 - Output Power (P_{3dB}): 12.5 W¹
 - Linear Gain: 18.4 dB¹
 - Typical PAE_{3dB}: 69.5%¹
 - Operating Voltage: 50 V
 - Low thermal resistance package
 - CW and Pulse capable
 - 6 x 5 mm package
- Note 1: @ 1 GHz (Loadpull)

Applications

- Basestation
- Active Antenna
- Military radar
- Civilian radar
- Land mobile and military radio communications
- Jammers

Ordering info

Part No.	ECCN	Description
QPD1014	EAR99	30–1200 MHz RF Transistor
QPD1014S2	EAR99	30–1200MHz RF Transistor Sample
QPD1014EVB01	EAR99	30–1000MHz EVB

Absolute Maximum Ratings¹

Parameter	Rating	Units
Breakdown Voltage, BV_{DG}	+145	V
Gate Voltage Range, V_G	-8 to +2	V
Drain Current, I_D	1	A
Gate Current Range, I_G	See page 4.	mA
Power Dissipation, CW, P_{DISS}	15.8	W
RF Input Power, CW, 50 Ω , $T = 25^\circ\text{C}$	+31	dBm
Channel Temperature, T_{CH}	275	$^\circ\text{C}$
Mounting Temperature (30 Seconds)	320	$^\circ\text{C}$
Storage Temperature	-40 to +150	$^\circ\text{C}$

Notes:

1. Operation of this device outside the parameter ranges given above may cause permanent damage.

Recommended Operating Conditions¹

Parameter	Min	Typ	Max	Units
Operating Temp. Range	-40	+25	+85	$^\circ\text{C}$
Drain Voltage Range, V_D	+12	+50	+55	V
Drain Bias Current, I_{DQ}	–	25	–	mA
Drain Current, I_D	–	500	–	mA
Gate Voltage, V_G^2	–	-2.8	–	V
Channel Temperature (T_{CH})	–	–	250	$^\circ\text{C}$
Power Dissipation, CW (P_D) ³	–	–	14.4	W

Notes:

1. Electrical performance is measured under conditions noted in the electrical specifications table. Specifications are not guaranteed over all recommended operating conditions.
2. To be adjusted to desired I_{DQ} .
3. Back plane of package at 85°C .

RF Characterization – Load Pull Performance – Power Tuned^{1, 2}

Parameters	Typical Values				Unit
Frequency, F	600	800	1000	1200	MHz
Linear Gain, G_{LIN}	20.1	21.0	21.5	20.8	dB
Output Power at 3dB compression point, P_{3dB}	41.9	42.4	42.7	42.3	dBm
Power-Added-Efficiency at 3dB compression point, PAE_{3dB}	65.0	62.0	63.0	60.0	%
Gain at 3dB compression point	17.1	18.0	18.5	17.8	dB

Notes:

1. Test conditions unless otherwise noted: $V_D = +50\text{ V}$, $I_{DQ} = 25\text{ mA}$, $Temp = +25\text{ }^\circ\text{C}$.
2. See page 16 for load pull and source pull reference planes.

RF Characterization – Load Pull Performance – Efficiency Tuned^{1, 2}

Parameters	Typical Values				Unit
Frequency	600	800	1000	1200	MHz
Linear Gain, G_{LIN}	21.8	22.6	23.0	21.2	dB
Output Power at 3dB compression point, P_{3dB}	39.0	39.7	41.2	40.7	dBm
Power-Added-Efficiency at 3dB compression point, PAE_{3dB}	79.2	70.7	72.6	70.4	%
Gain at 3dB compression point, G_{3dB}	18.8	19.6	20.0	18.2	dB

Notes:

1. Test conditions unless otherwise noted: $V_D = +50\text{ V}$, $I_{DQ} = 25\text{ mA}$, $Temp = +25\text{ }^\circ\text{C}$.
2. See page 16 for load pull and source pull reference planes.

RF Characterization – 30 – 1000 MHz EVB Performance At 1000 MHz¹

Parameter	Min	Typ	Max	Units
Linear Gain, G_{LIN}	–	21.1	–	dB
Output Power at 3dB compression point, P_{3dB}	–	40.8	–	dBm
Drain Efficiency at 3dB compression point, $DEFF_{3dB}$	–	67.4	–	%
Gain at 3dB compression point, G_{3dB}	–	18.1	–	dB

Notes:

1. Test conditions unless otherwise noted: $V_D = +50\text{ V}$, $I_{DQ} = 25\text{ mA}$, $Temp = +25\text{ }^\circ\text{C}$.

RF Characterization – Mismatch Ruggedness at 1000 MHz¹

Symbol	Parameter	dB Compression	Typical
VSWR	Impedance Mismatch Ruggedness	3	10:1

Notes:

1. Test conditions unless otherwise noted: $V_D = +50\text{ V}$, $I_{DQ} = 25\text{ mA}$, $Temp = +25\text{ }^\circ\text{C}$.

Maximum Gate Current

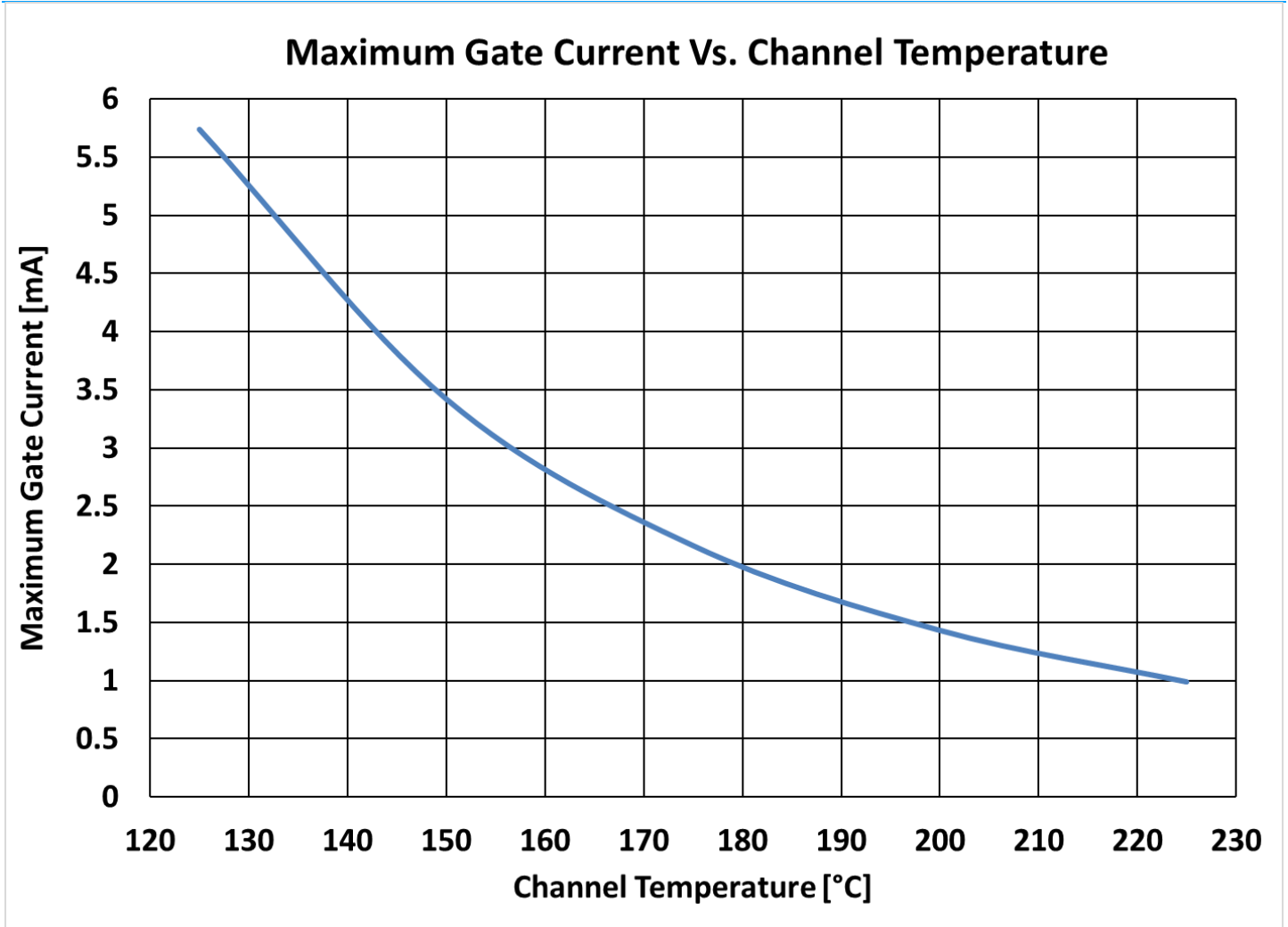

Median Lifetime¹

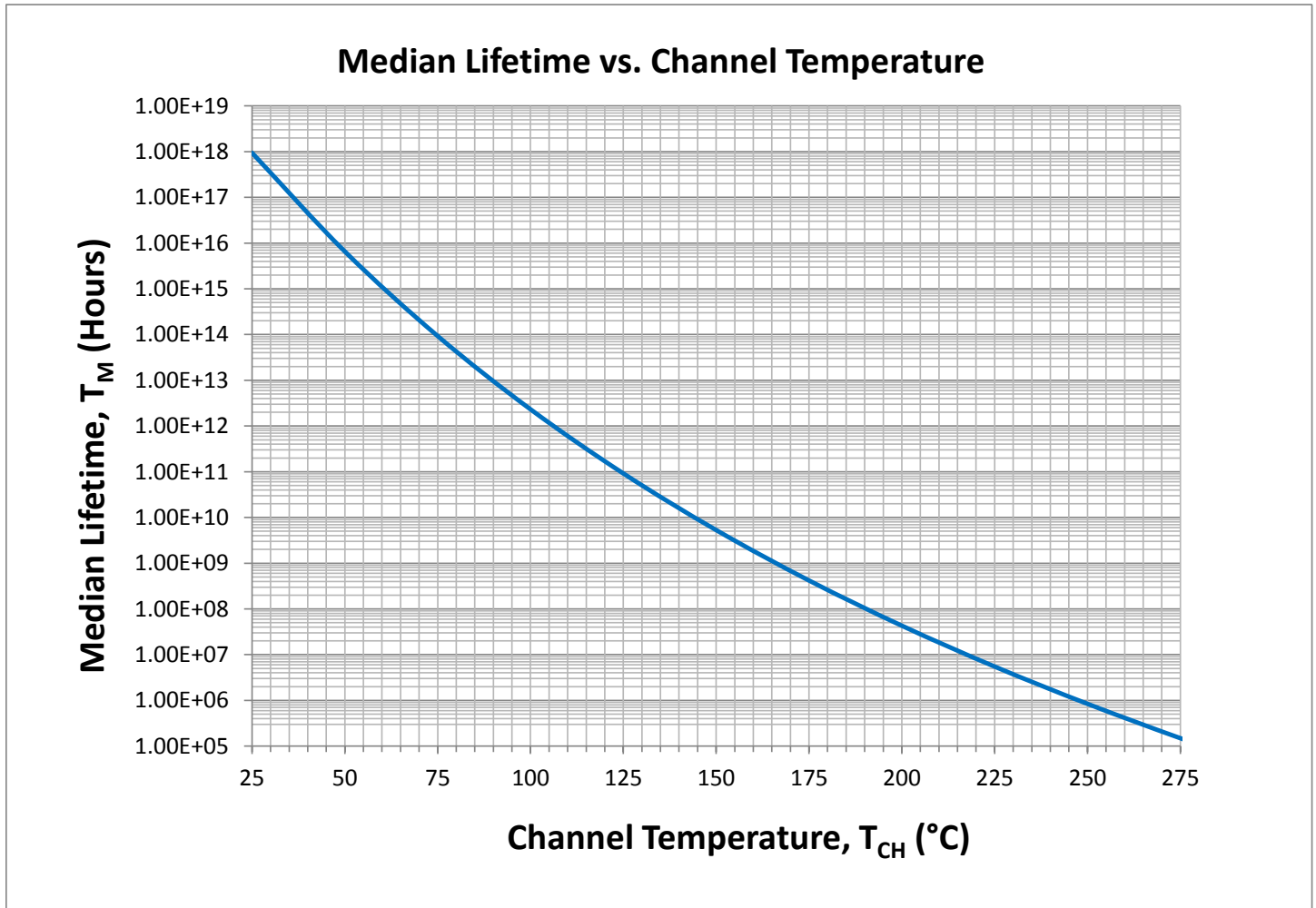

Notes:

1. For pulsed signals, average lifetime is average lifetime at maximum channel temperature divided by duty cycle.

Thermal and Reliability Information - CW

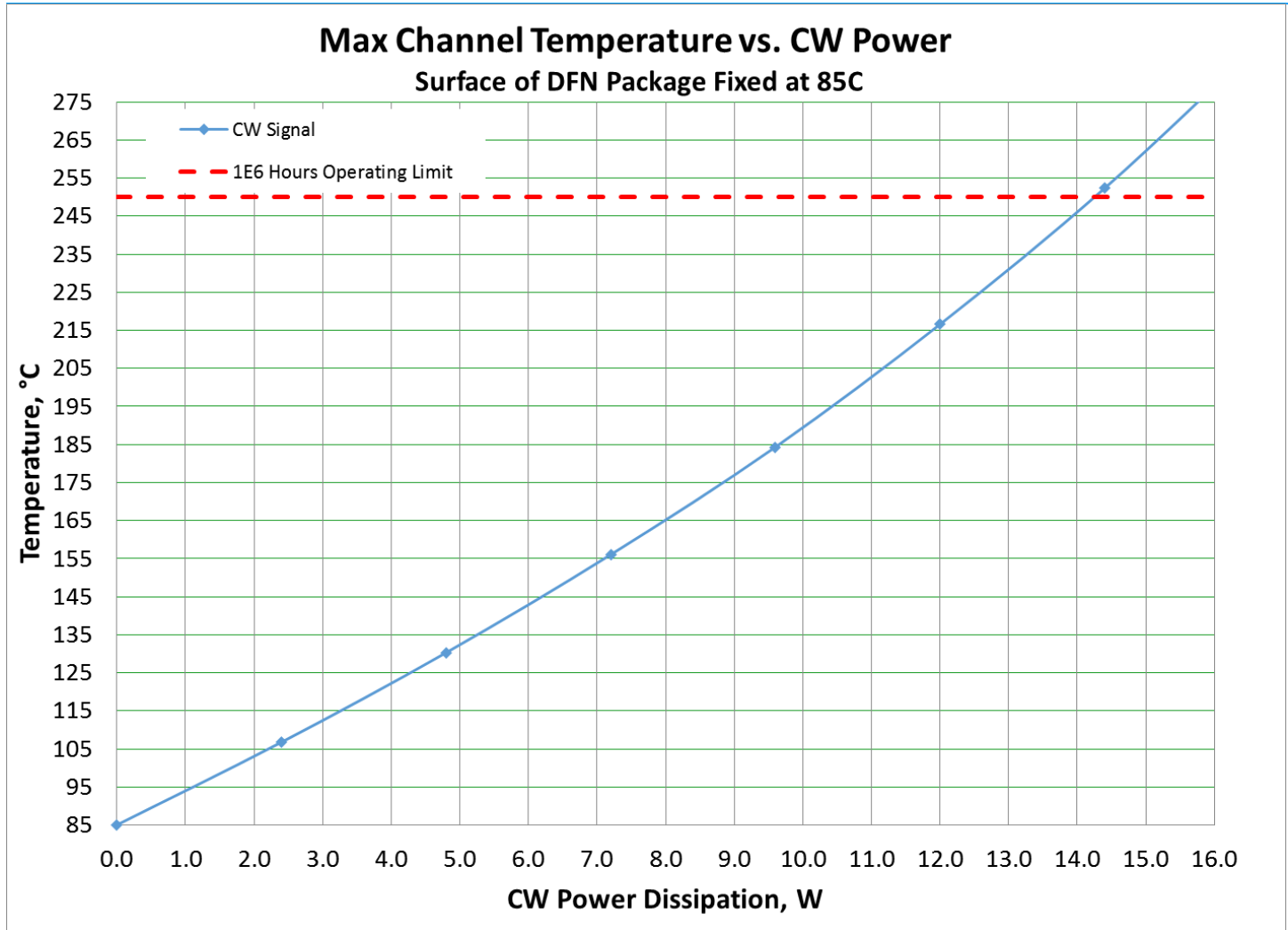

Parameter	Conditions	Values	Units
Thermal Resistance (θ_{JC})	85 °C Case 3 W P _{diss}	9.0	°C/W
Maximum Channel Temperature (T_{CH})		112	°C
Median Lifetime (T_M)		4.0E11	Hrs
Thermal Resistance (θ_{JC})	85 °C Case 6 W P _{diss}	9.5	°C/W
Maximum Channel Temperature (T_{CH})		142	°C
Median Lifetime (T_M)		1.0E10	Hrs
Thermal Resistance (θ_{JC})	85 °C Case 9 W P _{diss}	10.2	°C/W
Maximum Channel Temperature (T_{CH})		177	°C
Median Lifetime (T_M)		3.0E8	Hrs
Thermal Resistance (θ_{JC})	85 °C Case 12 W P _{diss}	11.0	°C/W
Maximum Channel Temperature (T_{CH})		217	°C
Median Lifetime (T_M)		8.0E6	Hrs

Load Pull Smith Charts^{1,2}

Notes:

1. $V_d = 50\text{ V}$, $I_{DQ} = 25\text{ mA}$, $\text{Temp} = +25\text{ }^\circ\text{C}$.
2. See page 16 for load pull and source pull reference planes.

600 MHz, Load-pull

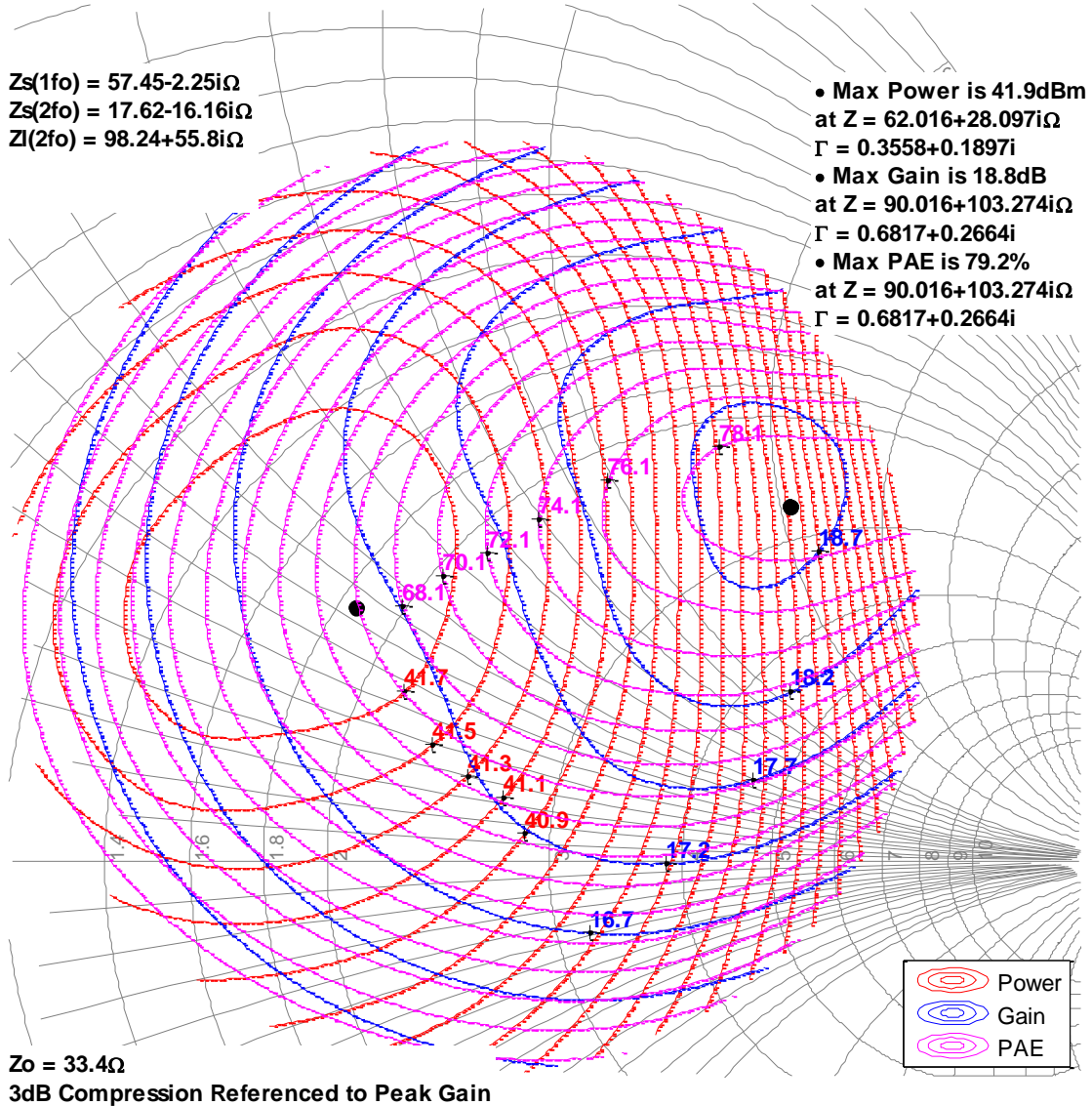

Load Pull Smith Charts^{1,2}

Notes:

1. $V_d = 50\text{ V}$, $I_{DQ} = 25\text{ mA}$, $\text{Temp} = +25\text{ }^\circ\text{C}$.
2. See page 16 for load pull and source pull reference planes.

800 MHz, Load-pull

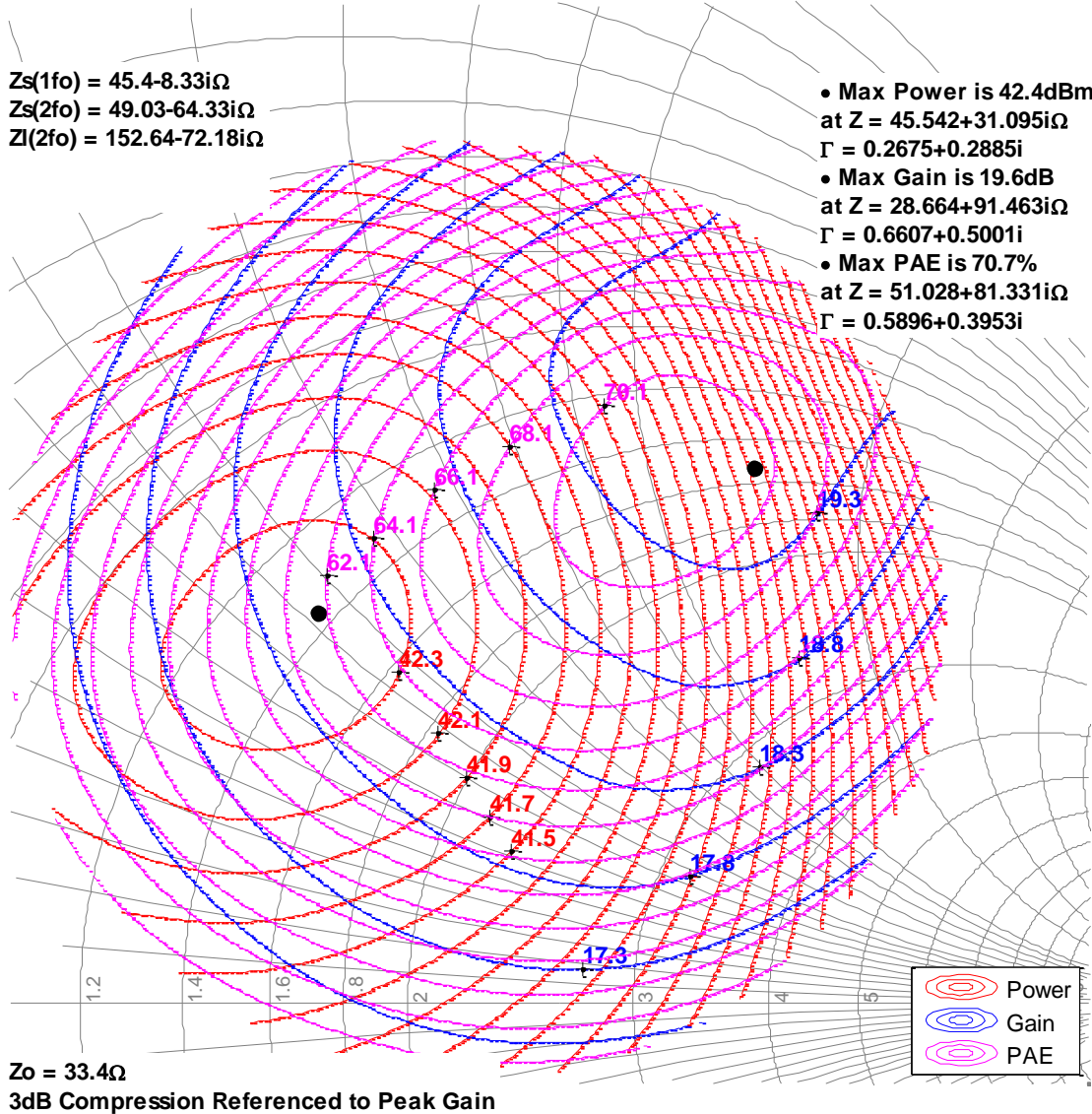

Load Pull Smith Charts^{1,2}

Notes:

1. $V_d = 50\text{ V}$, $I_{DQ} = 25\text{ mA}$, $\text{Temp} = +25\text{ }^\circ\text{C}$.
2. See page 16 for load pull and source pull reference planes.

1000 MHz, Load-pull

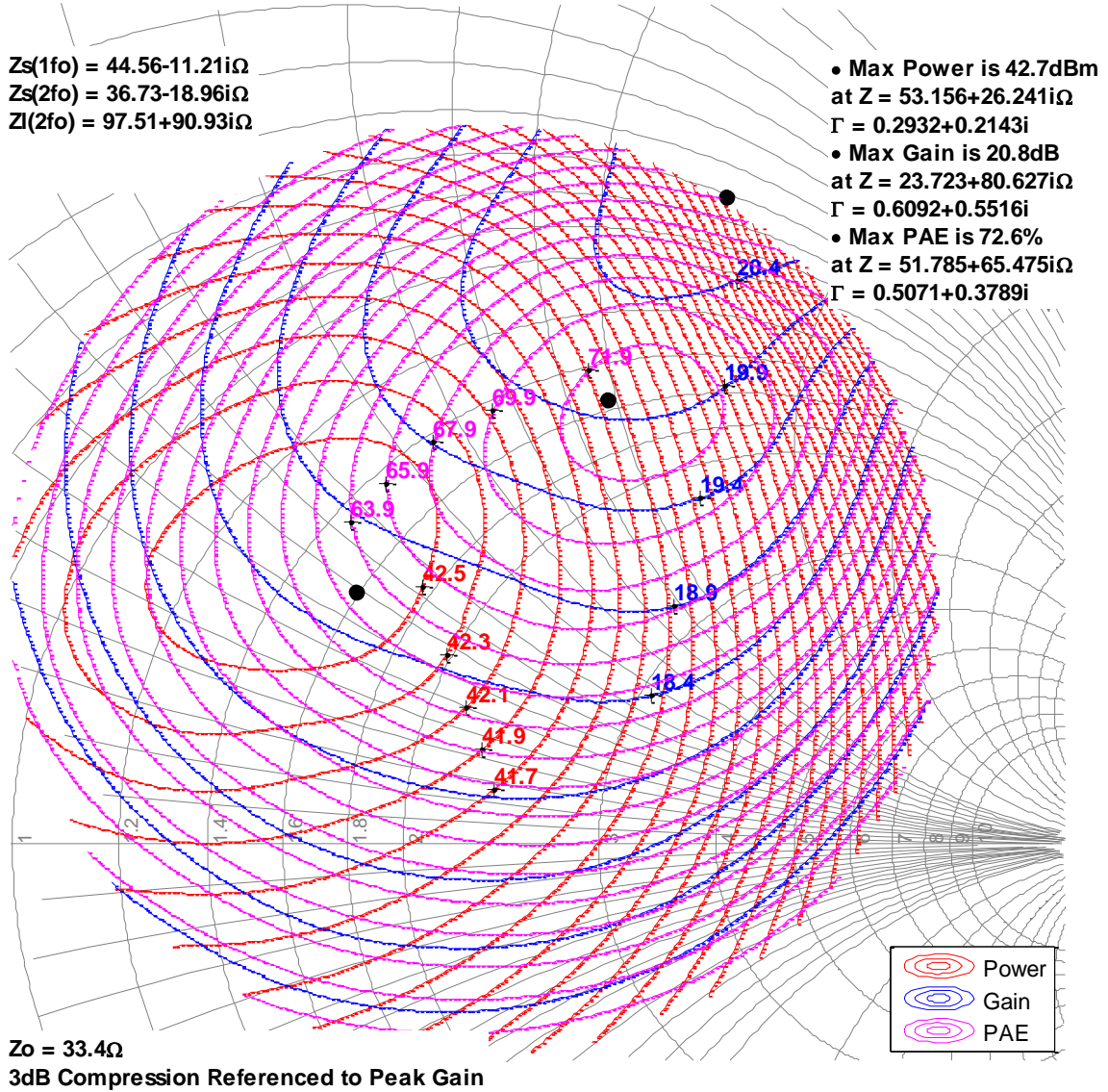

Load Pull Smith Charts^{1,2}

Notes:

1. $V_d = 50\text{ V}$, $I_{DQ} = 25\text{ mA}$, $\text{Temp} = +25\text{ }^\circ\text{C}$.
2. See page 16 for load pull and source pull reference planes.

1200 MHz, Load-pull

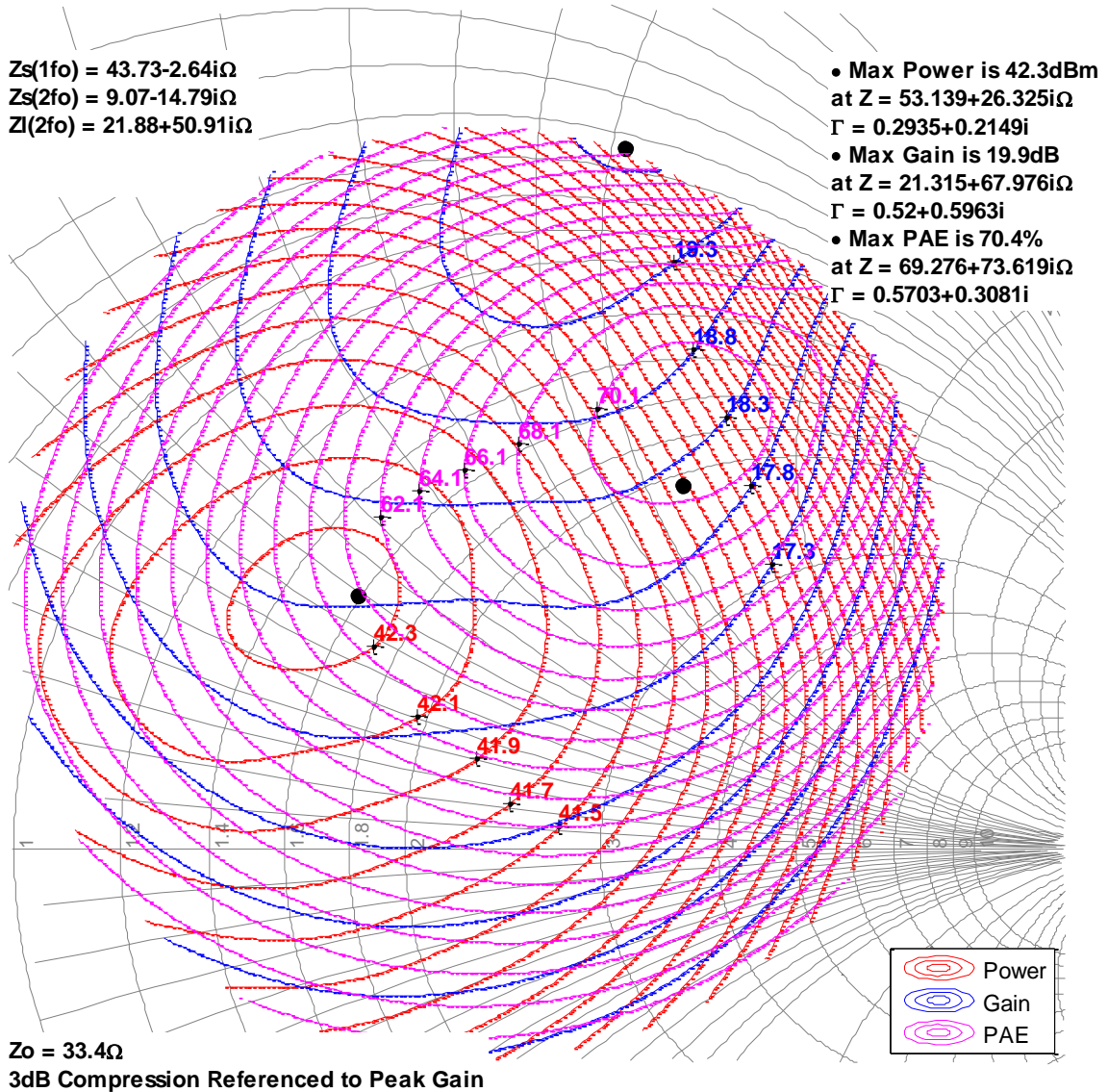

Typical Performance – Load Pull Drive-up^{1, 2}

Notes:

1. $V_d = 50\text{ V}$, $I_{DQ} = 25\text{ mA}$, $\text{Temp} = +25\text{ }^\circ\text{C}$.
2. See page 16 for load pull and source pull reference planes.

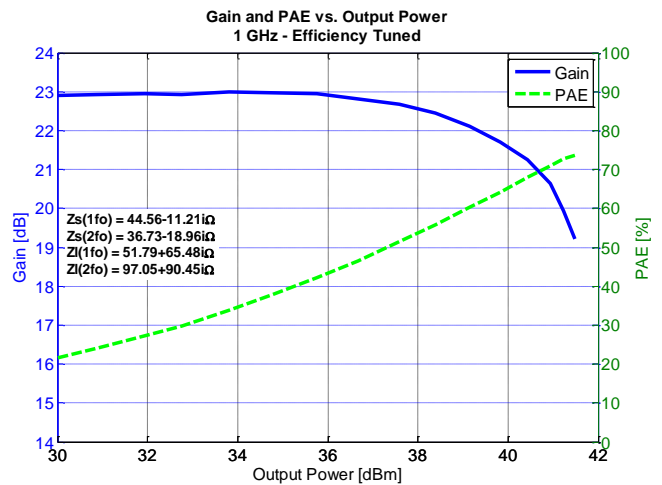
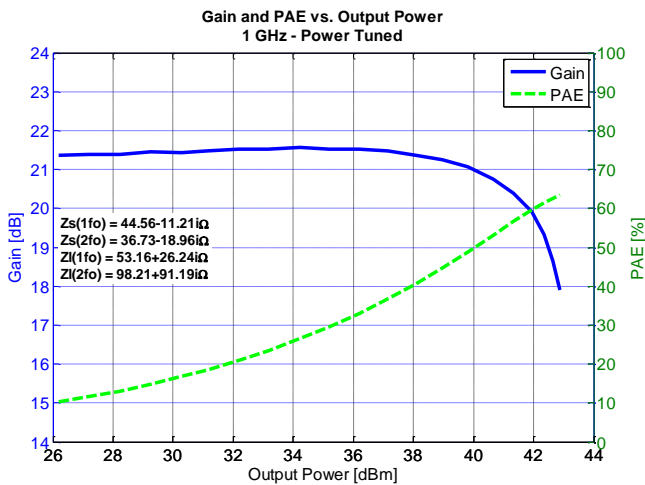
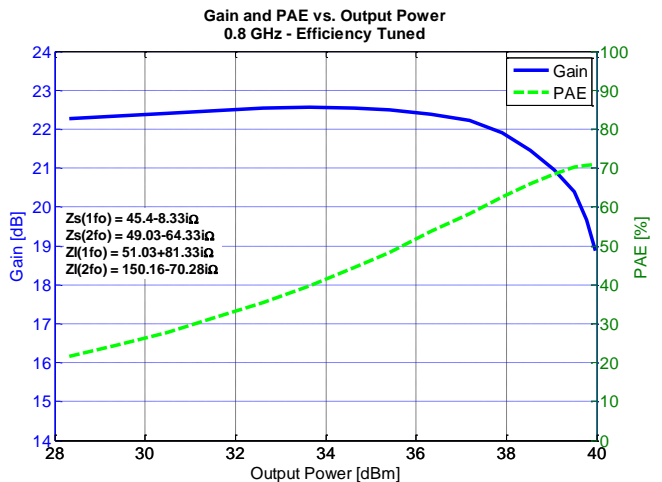
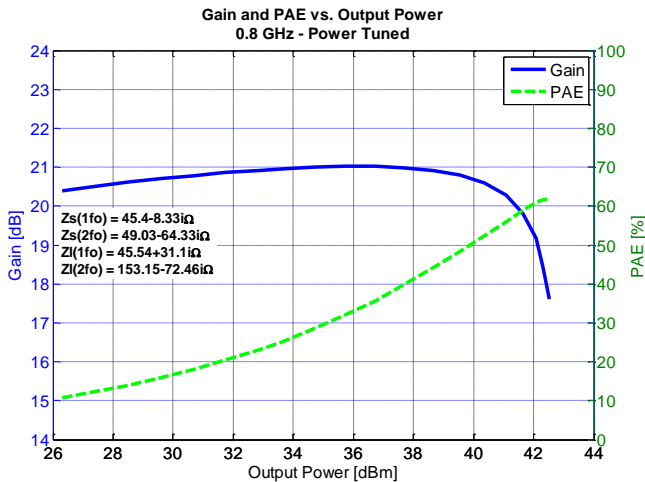
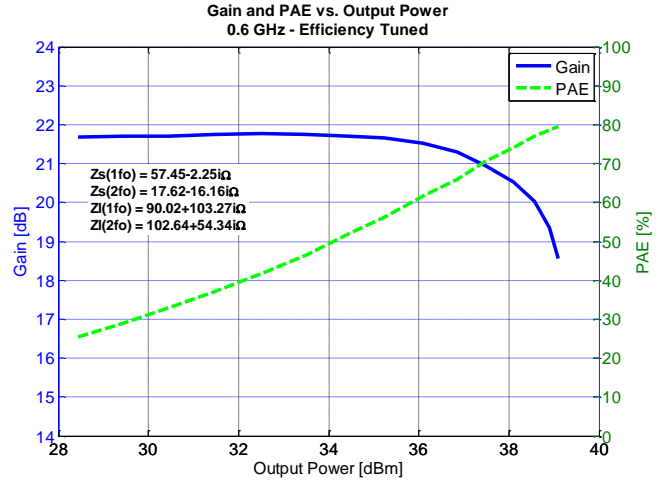
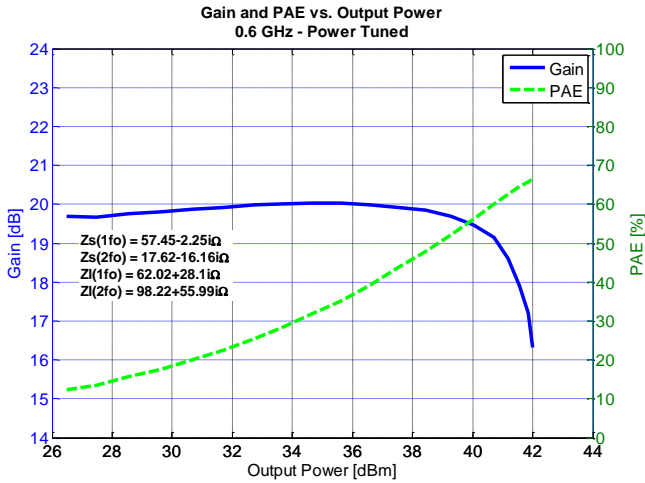

Typical Performance – Load Pull Drive-up^{1, 2}

Notes:

1. $V_d = 50\text{ V}$, $I_{DQ} = 25\text{ mA}$, $\text{Temp} = +25\text{ }^\circ\text{C}$.
2. See page 16 for load pull and source pull reference planes.

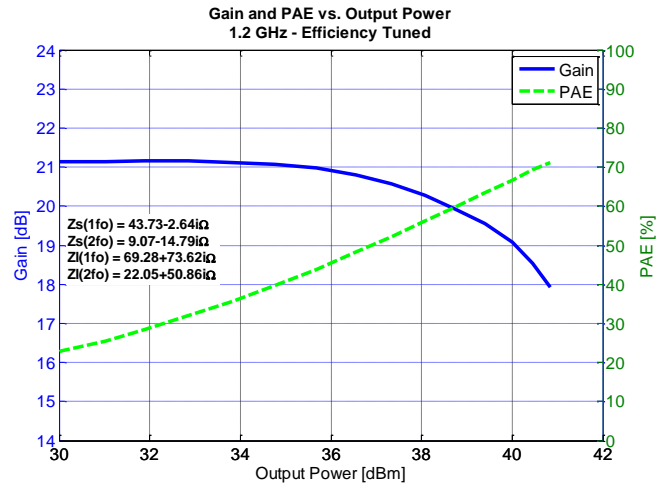
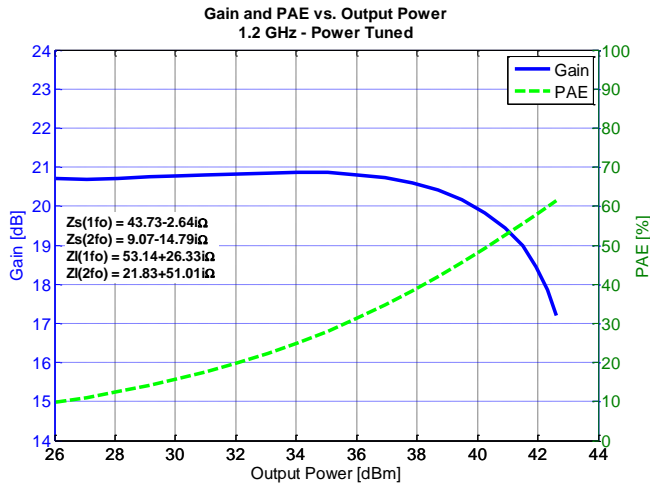

Power Driveup Performance Over Temperatures Of 30 – 1000 MHz EVB¹

Notes:

1. $V_d = 50\text{ V}$, $I_{DQ} = 25\text{ mA}$, $\text{Temp} = +25\text{ }^\circ\text{C}$.

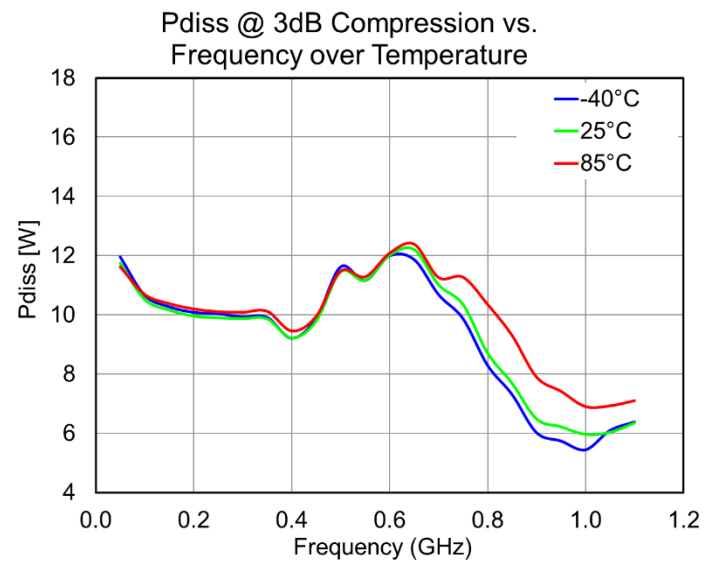
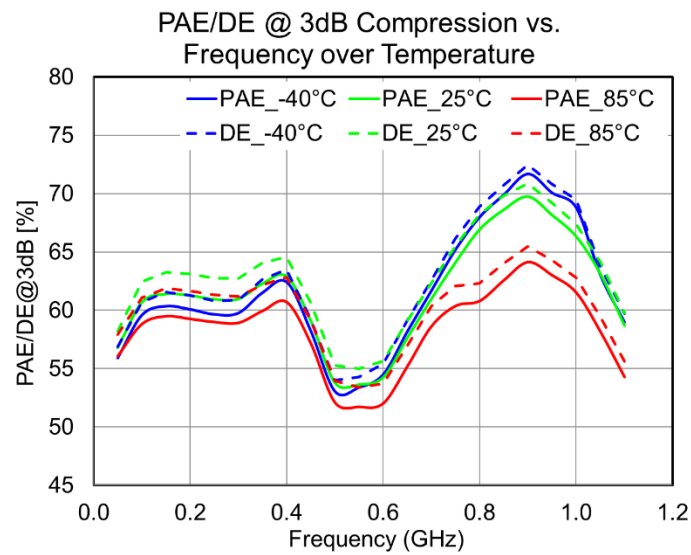
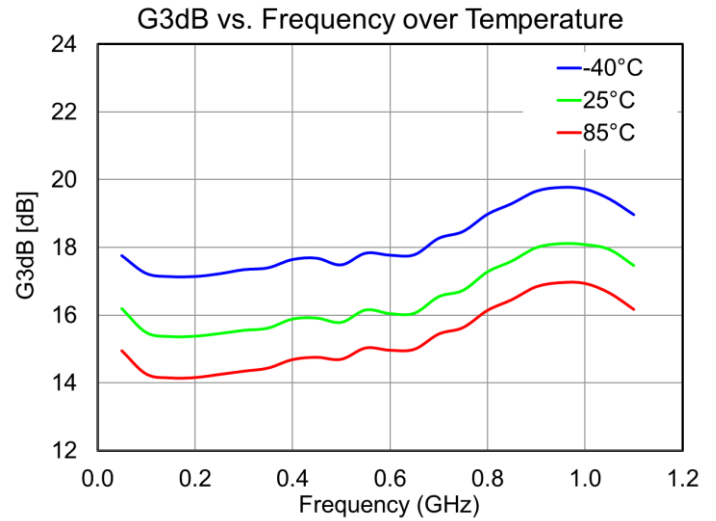
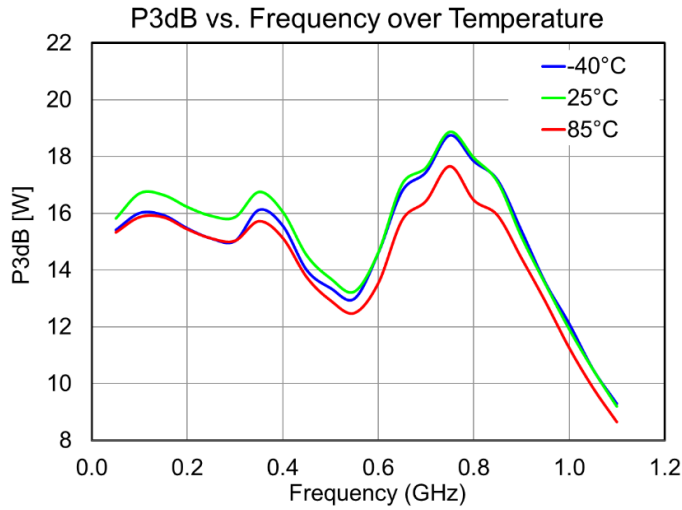

Power Driveup Performance At 25 °C Of 30 – 1000 MHz EVB¹

Notes:

1. $V_d = 50\text{ V}$, $I_{DQ} = 25\text{ mA}$, $Temp = +25\text{ °C}$.

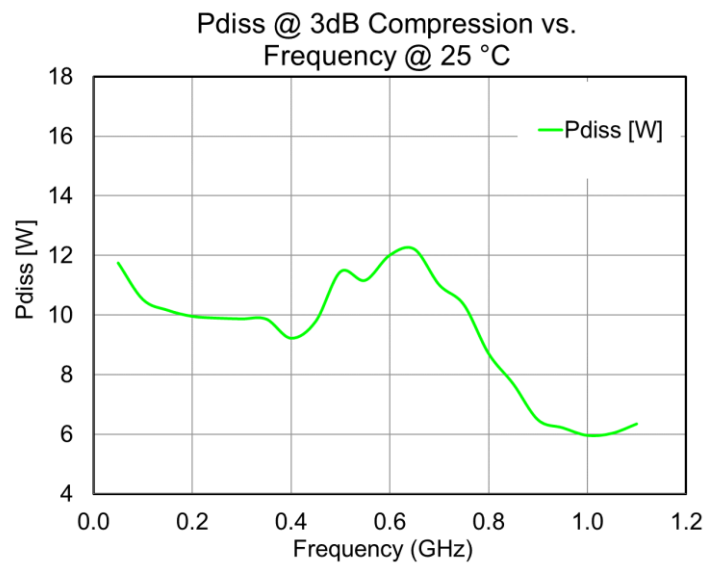
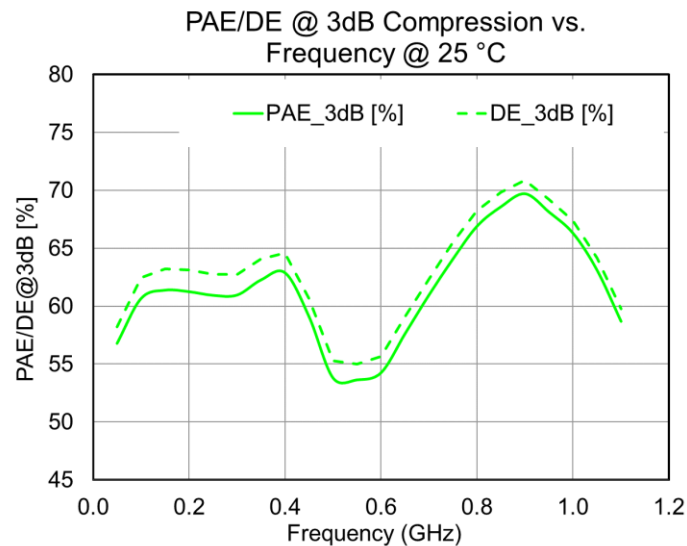
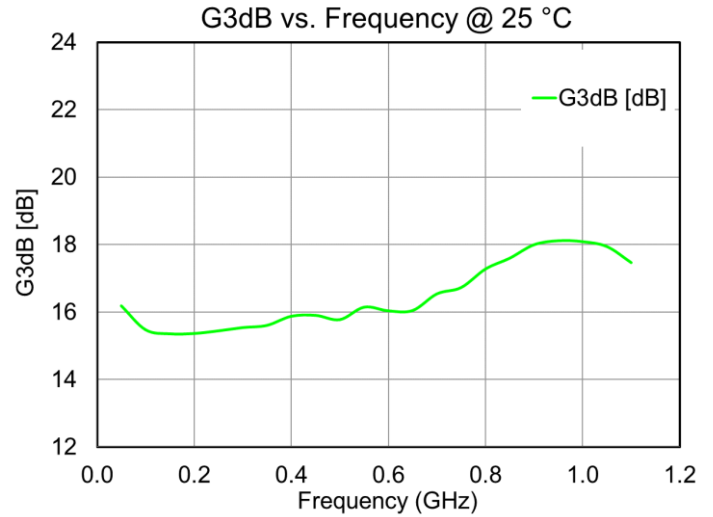
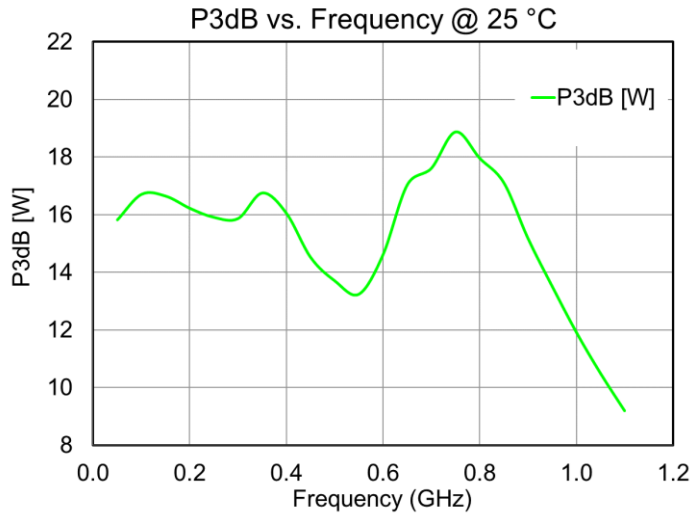

Two-Tone Performance At 25 °C Of 30 – 1000 MHz EVB¹

Notes:

- Center Frequency = 450 MHz, Tone Separation = 1 MHz, Temp = +25 °C.

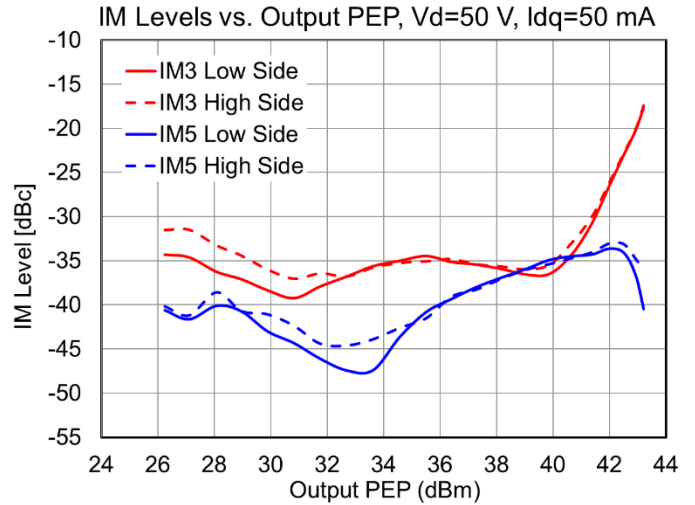
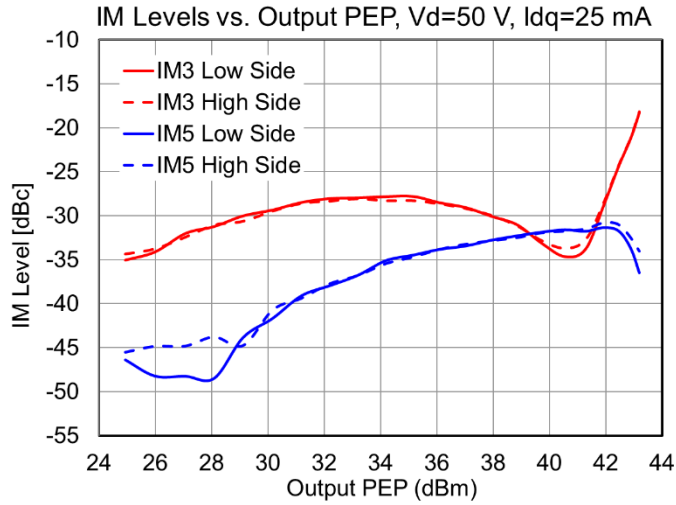

Pin Layout¹

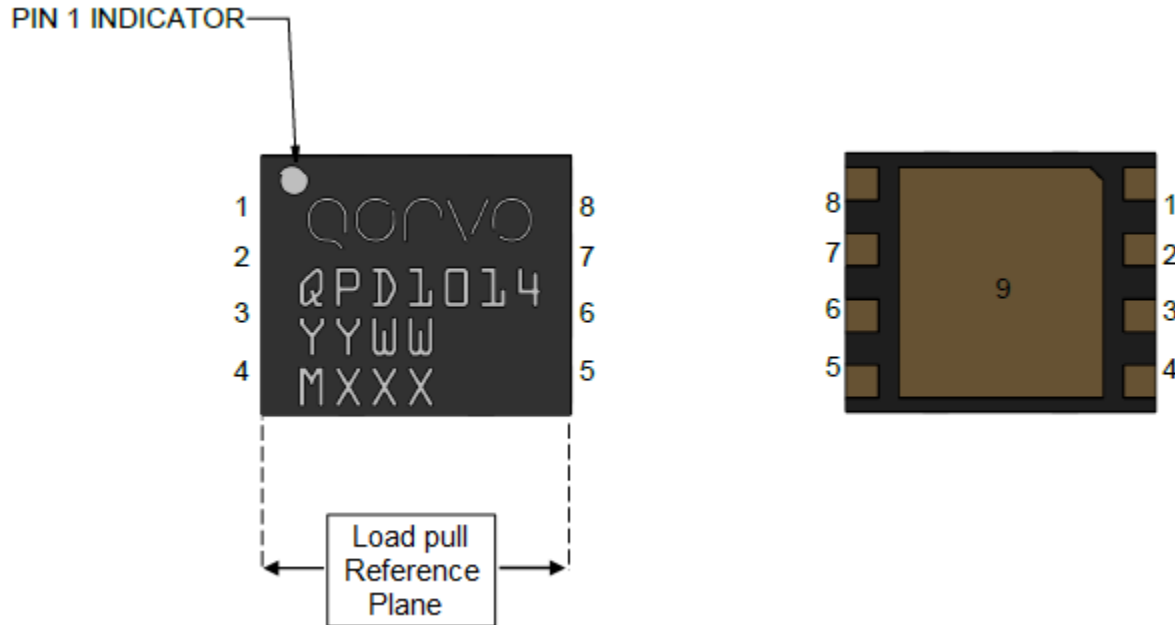

Notes:

- The QPD1014 will be marked with the “QPD1014” designator and a lot code marked below the part designator. The “YY” represents the last two digits of the calendar year the part was manufactured, the “WW” is the work week of the assembly lot start and the “MXXX” is the production lot number.

Pin Description

Pin	Symbol	Description
1	VG	Gate Voltage
2, 3	RF IN	RF Input
4, 5, 8	NC	Not Connected
6, 7	RF OUT / VD	RF Output / Drain voltage
9	GND	Source to be connected to ground

Mechanical Drawing¹

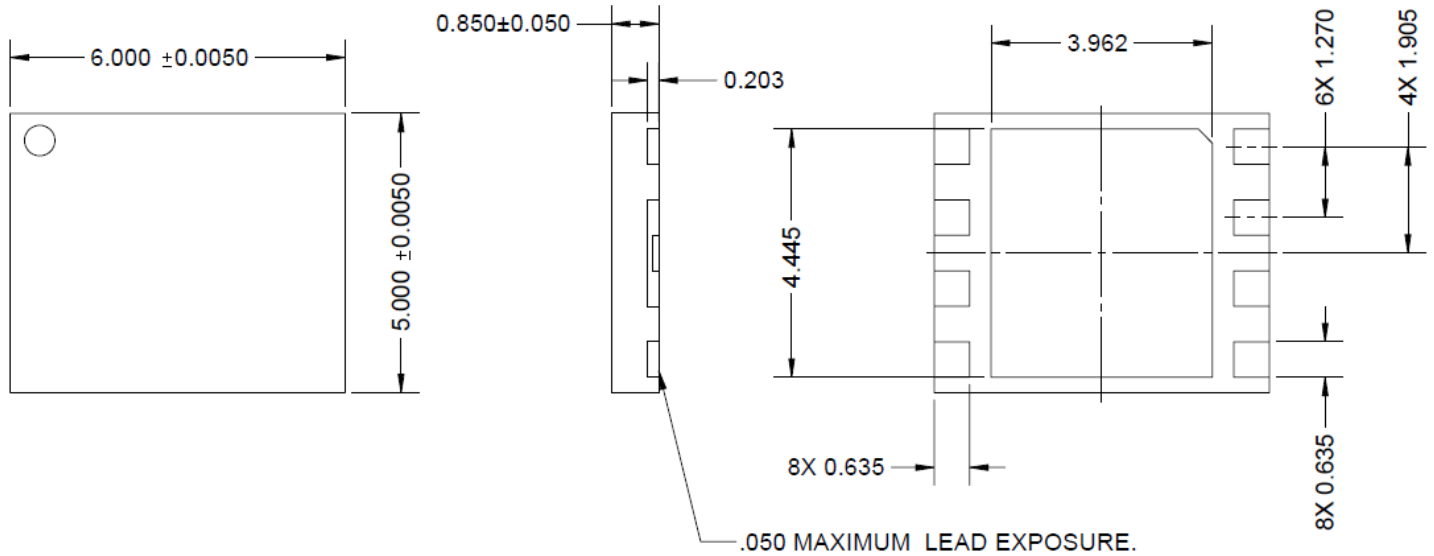

Notes:

1. All dimensions are in mm. otherwise noted. The tolerance is ± 0.127 mm.

Bias-up Procedure	Bias-down Procedure
1. Set V_G to -4 V.	1. Turn off RF signal.
2. Set ID current limit to 50 mA.	2. Turn off VD.
3. Apply 50 V VD.	3. Wait 2 seconds to allow drain capacitor to discharge.
4. Slowly adjust VG until ID is set to 25 mA.	4. Turn off VG.
5. Set ID current limit to 1 A.	
6. Apply RF.	

PCB Layout – 30 – 1000 MHz EVB¹

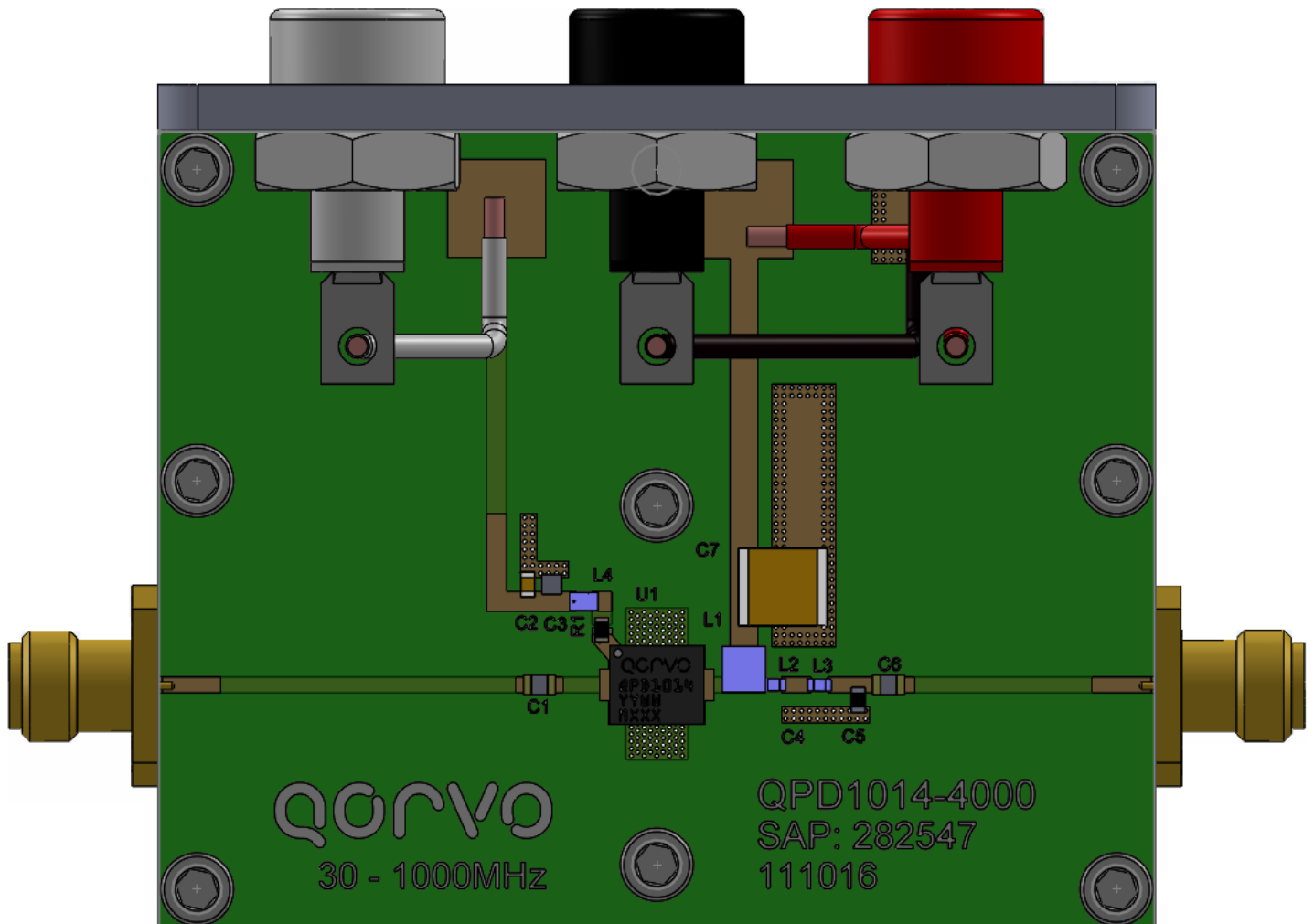

Notes:

1. PCB Material is RO4350B, 20mil thick substrate, 1/2oz. copper each side.



Bill Of material – 30 – 1000 MHz EVB

Ref Des	Value	Description	Manufacturer	Part Number
U1	-	15W, 30-1200MHz, GaN Transistor	Qorvo	QPD1014
C1,C6	2400 pF	CAP MLCC 2400PF TC +/-15% 50V 0805	Dielectric Labs	C08BL242X-5UN-X0T
C2	10 nF	CAP, SMT 0603 10nF	AVX Corporation	0603YC103KAT2A
C3	10 uF	CAP, CER, SMD 10UF, 10%, 10V, 0805, X7R	Murata Electronics	GRM21BR71A106KE51L
C5	2.0 pF	CAP CER 2PF 250V +/-0.05PF 0603	ATC	600S2R0AT250XT
C7	4.7 uF	CAP CER 4.7UF 100V 10% X7R 2220	Murata Electronics	GRM55ER72A475KA01L
L1	900 nH	IND FERRITE 900nH 1008 5%	Coilcraft, Inc.	1008AF-901XJLC
L2	3.9 nH	IND CER 3.9nH 0603 2%	Coilcraft, Inc.	0603HC-3N9XGLW
L3	6.8 nH	IND CER 6.8nH 5% 0603	Coilcraft, Inc.	0603HC-6N8XGJE
L4	1000 nH	IND FERRITE 1000nH 0603 2%	Coilcraft, Inc.	0603LS-102XGLC
R1	10 Ω	RES 10 OHM 1/10W +-5% 0603	Vishay Dale	CRCW060310R0JNEA
RFIN,RFOUT	-	CONNECTOR, SMA	Gigalane	PSF-S00-000

Recommended Solder Temperature Profile

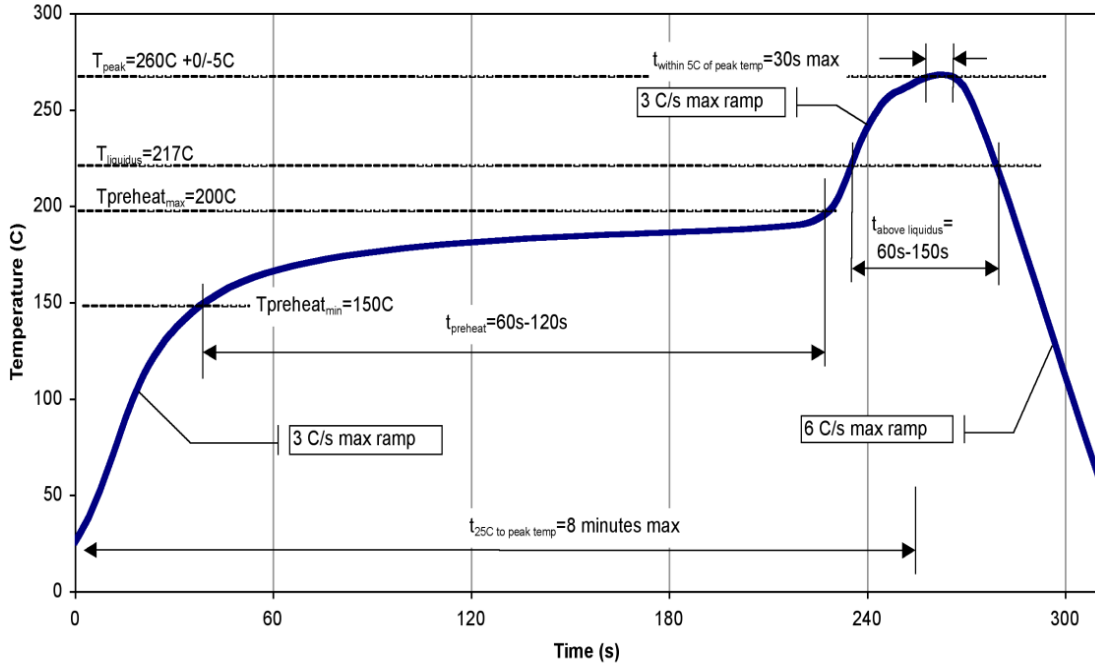

Product Compliance Information

ESD Sensitivity Ratings



Caution! ESD Sensitive Device

ESD Rating

ESD Rating: TBD
Value: TBD
Test: Human Body Model (HBM)
Standard: JEDEC Standard JESD22-A114

MSL Rating

MSL Rating: TBD
Test: 260 °C convection reflow
Standard: JEDEC Standard IPC/JEDEC J-STD-020

Solderability

Compatible with lead free soldering processes, 260 °C maximum reflow temperature.

Package lead plating: NiAu

The use of no-clean solder to avoid washing after soldering is recommended.

This part is compliant with EU 2002/95/EC RoHS directive (Restrictions on the Use of Certain Hazardous Substances in Electrical and Electronic Equipment).

This product also has the following attributes:

- Lead Free
- Halogen Free (Chlorine, Bromine)
- Antimony Free
- TBBP-A (C₁₅H₁₂Br₄O₂) Free
- PFOS Free
- SVHC Free

Contact Information

For the latest specifications, additional product information, worldwide sales and distribution locations, and information about Qorvo:

Web: www.Qorvo.com
Email: info-sales@qorvo.com

Tel: +1.972.994.8465
Fax: +1.972.994.8504

For technical questions and application information: Email: info-products@qorvo.com

Important Notice

The information contained herein is believed to be reliable. Qorvo makes no warranties regarding the information contained herein. Qorvo assumes no responsibility or liability whatsoever for any of the information contained herein. Qorvo assumes no responsibility or liability whatsoever for the use of the information contained herein. The information contained herein is provided "AS IS, WHERE IS" and with all faults, and the entire risk associated with such information is entirely with the user. All information contained herein is subject to change without notice. Customers should obtain and verify the latest relevant information before placing orders for Qorvo products. The information contained herein or any use of such information does not grant, explicitly or implicitly, to any party any patent rights, licenses, or any other intellectual property rights, whether with regard to such information itself or anything described by such information.

Qorvo products are not warranted or authorized for use as critical components in medical, life-saving, or life-sustaining applications, or other applications where a failure would reasonably be expected to cause severe personal injury or death.

X-ON Electronics

Largest Supplier of Electrical and Electronic Components

Click to view similar products for [RF Development Tools](#) category:

Click to view products by [Qorvo](#) manufacturer:

Other Similar products are found below :

[MAAM-011117](#) [MAAP-015036-DIEEV2](#) [EV1HMC1113LP5](#) [EV1HMC6146BLC5A](#) [EV1HMC637ALP5](#) [EVAL-ADG919EBZ](#) [ADL5363-EVALZ](#) [LMV228SDEVAL](#) [SKYA21001-EVB](#) [SMP1331-085-EVB](#) [EV1HMC618ALP3](#) [EVAL01-HMC1041LC4](#) [MAAL-011111-000SMB](#)
[MAAM-009633-001SMB](#) [MASW-000936-001SMB](#) [107712-HMC369LP3](#) [107780-HMC322ALP4](#) [SP000416870](#) [EV1HMC470ALP3](#)
[EV1HMC520ALC4](#) [EV1HMC244AG16](#) [MAX2614EVKIT#](#) [124694-HMC742ALP5](#) [SC20ASATEA-8GB-STD](#) [MAX2837EVKIT+](#)
[MAX2612EVKIT#](#) [MAX2692EVKIT#](#) [EV1HMC629ALP4E](#) [SKY12343-364LF-EVB](#) [108703-HMC452QS16G](#) [EV1HMC863ALC4](#)
[EV1HMC427ALP3E](#) [119197-HMC658LP2](#) [EV1HMC647ALP6](#) [ADL5725-EVALZ](#) [106815-HMC441LM1](#) [EV1HMC1018ALP4](#)
[UXN14M9PE](#) [MAX2016EVKIT](#) [EV1HMC939ALP4](#) [MAX2410EVKIT](#) [MAX2204EVKIT+](#) [EV1HMC8073LP3D](#) [SIMSA868-DKL](#)
[SIMSA868C-DKL](#) [SKY65806-636EK1](#) [SKY68020-11EK1](#) [SKY67159-396EK1](#) [SKY66181-11-EK1](#) [SKY65804-696EK1](#)