

### General Description

The QPD1015 is a 65 W ( $P_{3dB}$ ) wideband unmatched discrete GaN on SiC HEMT which operates from DC to 3.7 GHz with a 50V supply rail. The device is in an industry standard air cavity package and is ideally suited for military and civilian radar, land mobile and military radio communications, avionics, and test instrumentation. The device can support pulsed, CW, and linear operation.

Lead-free and ROHS compliant

Evaluation boards are available upon request.



### Functional Block Diagram

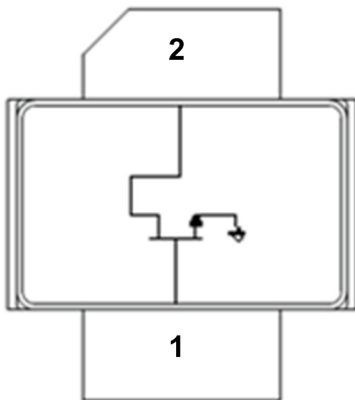

### Product Features

- Frequency: DC to 3.7 GHz
  - Output Power ( $P_{3dB}$ )<sup>1</sup>: 70 W
  - Linear Gain<sup>1</sup>: 20 dB
  - Typical PAE<sub>3dB</sub><sup>1</sup>: 74%
  - Operating Voltage: 50 V
  - Low thermal resistance package
  - CW and Pulse capable
- Note: 1 @ 2 GHz

### Applications

- Military radar
- Civilian radar
- Land mobile and military radio communications
- Test instrumentation
- Wideband or narrowband amplifiers
- Jammers
- Avionics

### Ordering info

Part No.	ECCN	Description
QPD1015	EAR99	DC–3.7 GHz 65W RF Transistor
QPD1015PCB401	EAR99	0.96 – 1.215 GHz EVB
QPD1015EVB2	EAR99	3.0 – 3.5 GHz EVB

## Absolute Maximum Ratings<sup>1</sup>

Parameter	Rating	Units
Breakdown Voltage, $BV_D$	+145	V
Gate Voltage Range, $V_G$	-7 to +2	V
Drain Current, $I_{D_{MAX}}$	10.2	A
Gate Current Range, $I_G$	See pg. 7.	mA
Power Dissipation, CW, $P_{DISS}$ , Base Temperature = 85 °C	40	W
RF Input Power, CW, 50 $\Omega$ , T = 25 °C	+37	dBm
Channel Temperature, $T_{CH}$	275	°C
Mounting Temperature (30 Seconds)	320	°C
Storage Temperature	-40 to +150	°C

Notes:

1. . Operation of this device outside the parameter ranges given above may cause permanent damage.

## Recommended Operating Conditions<sup>1</sup>

Parameter	Min	Typ	Max	Units
Operating Temperature Range	-40	+25	+85	°C
Drain Voltage Range, $V_D$	+12	+50	+55	V
Drain Current, $I_D^3$	-	2.5	-	A
Drain Bias Current, $I_{DQ}$	-	65	-	mA
Gate Voltage, $V_G^4$	-	-2.8	-	V
Channel Temperature, $T_{CH}$	-	-	250	°C
Power Dissipation, CW, $P_D^2$	-	-	36	W
Power Dissipation, Pulsed, $P_D^{2, 3}$	-	-	64	W

Notes:

1. Electrical performance is measured under conditions noted in the electrical specifications table. Specifications are not guaranteed over all recommended operating conditions.
2. Package base at 85 °C
3. Drain current at P3dB, Pulse Width = 128  $\mu$ S, Duty Cycle = 10%
4. To be adjusted for desired  $I_{DQ}$

### Pulsed Characterization – Load-Pull Performance – Power Tuned

Parameters	Typical Values				Unit
Frequency, F	1	2	3	3.5	GHz
Linear Gain, $G_{LIN}$	25.3	20.2	16.1	14.6	dB
Output Power at 3dB compression point, $P_{3dB}$	48.4	48.5	48.7	48.7	dBm
Power-Added-Efficiency at 3dB compression point, $PAE_{3dB}$	67.3	62.1	58.6	51.1	%
Gain at 3dB compression point	22.3	17.2	13.1	11.6	dB

Notes:

1. Test conditions unless otherwise noted:  $V_D = +50$  V,  $I_{DQ} = 65$  mA, Temp = +25 °C

### Pulsed Characterization – Load-Pull Performance – Efficiency Tuned

Parameters	Typical Values				Unit
Frequency, F	1	2	3	3.5	GHz
Linear Gain, $G_{LIN}$	26.0	21.5	16.6	15.8	dB
Output Power at 3dB compression point, $P_{3dB}$	45.6	46.9	47.1	47.8	dBm
Power-Added-Efficiency at 3dB compression point, $PAE_{3dB}$	75.4	74.1	69.0	59.4	%
Gain at 3dB compression point, $G_{3dB}$	23.0	18.5	13.6	12.8	dB

Notes:

1. Test conditions unless otherwise noted:  $V_D = +50$  V,  $I_{DQ} = 65$  mA, Temp = +25 °C

### 0.96 – 1.215 GHz EVB Performance<sup>1</sup>

Parameter	Min	Typ	Max	Units
Linear Gain, $G_{LIN}$	16	18	–	dB
Output Power at 3dB compression point, $P_{3dB}$	50	60	–	W
Drain Efficiency at 3dB compression point, $DEFF_{3dB}$	50	63.5	–	%
Gain at 3dB compression point, $G_{3dB}$	13	15	–	dB

Notes:

1. F = 1.1 GHz,  $V_D = +50$  V,  $I_{DQ} = 65$  mA, Temp = +25 °C, Pulse Width = 128 uS, Duty Cycle = 10%

### RF Characterization – Mismatch Ruggedness at 1.1 GHz

Symbol	Parameter	dB Compression	Typical
VSWR	Impedance Mismatch Ruggedness	3	10:1

Test conditions unless otherwise noted:  $T_A = 25$  °C,  $V_D = 50$  V,  $I_{DQ} = 65$  mA

Input drive power is determined at pulsed 3dB compression under matched condition at EVB output connector.

**Median Lifetime<sup>1</sup>**

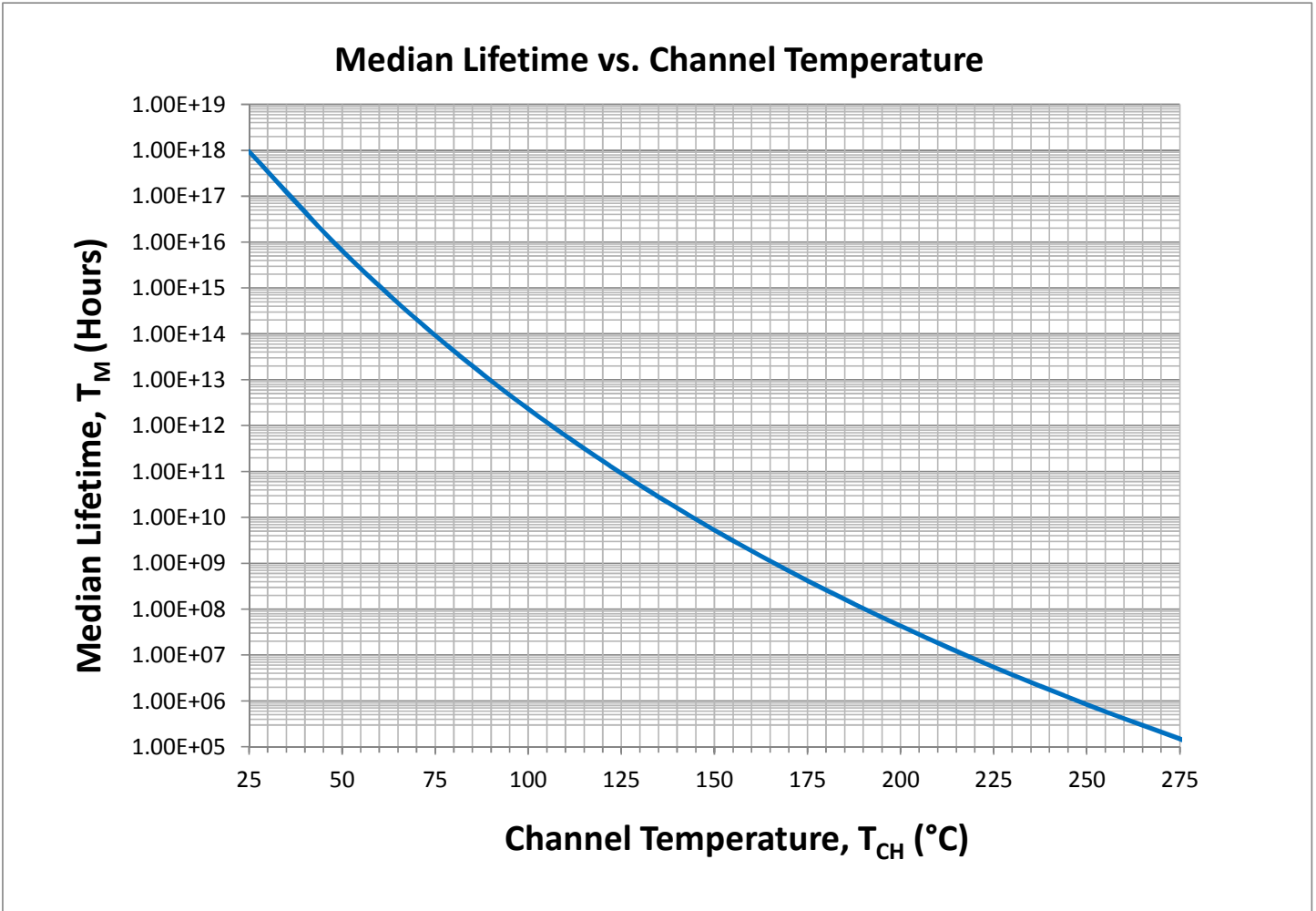

<sup>1</sup> For pulsed signals, average lifetime is average lifetime at maximum channel temperature divided by duty cycle.

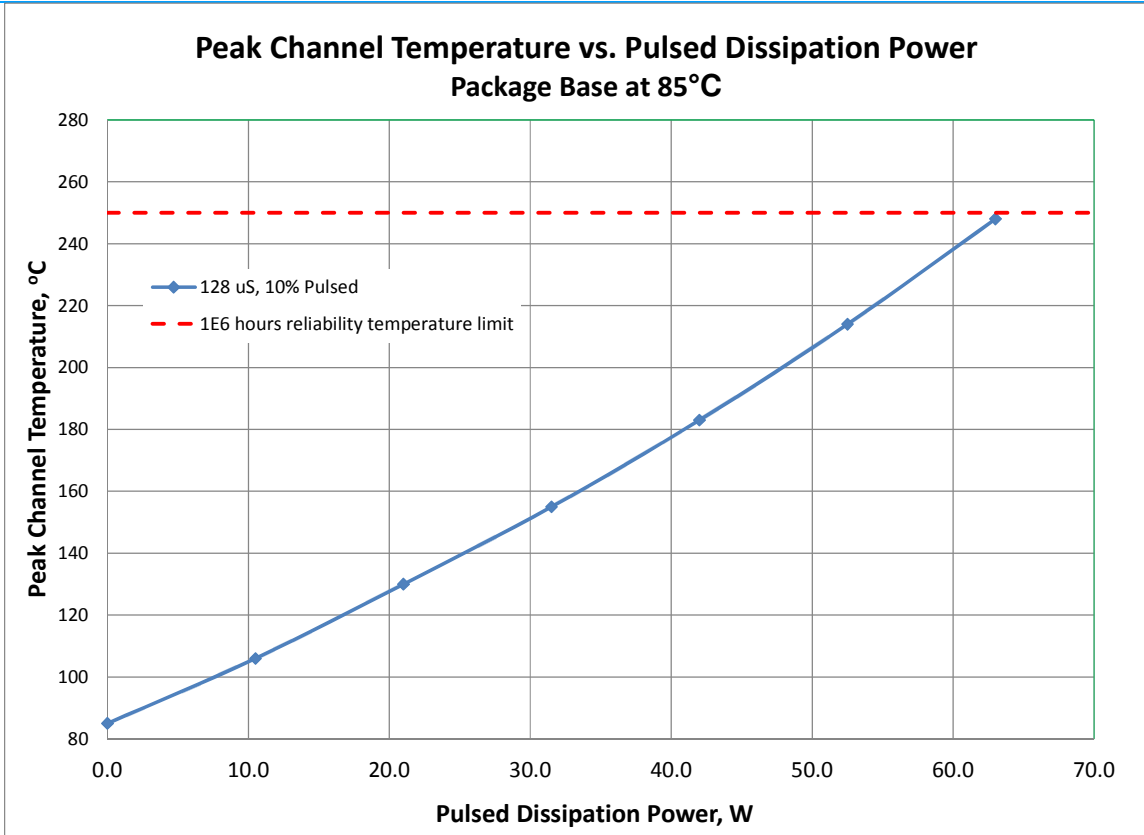
**Thermal and Reliability Information - Pulsed**

Parameter	Conditions	Values	Units
Thermal Resistance ( $\theta_{JC}$ )	85 °C Case	2.00	°C/W
Peak Channel Temperature ( $T_{CH}$ )	10.5 W Pdiss, 128 uS PW, 10% DC	106	°C
Median Lifetime ( $T_M$ )		1.1E13	Hrs
Thermal Resistance ( $\theta_{JC}$ )	85 °C Case	2.14	°C/W
Peak Channel Temperature ( $T_{CH}$ )	21 W Pdiss, 128 uS PW, 10% DC	130	°C
Median Lifetime ( $T_M$ )		5.2E11	Hrs
Thermal Resistance ( $\theta_{JC}$ )	85 °C Case	2.22	°C/W
Peak Channel Temperature ( $T_{CH}$ )	31.5 W Pdiss, 128 uS PW, 10% DC	155	°C
Median Lifetime ( $T_M$ )		3.2E10	Hrs
Thermal Resistance ( $\theta_{JC}$ )	85 °C Case	2.33	°C/W
Peak Channel Temperature ( $T_{CH}$ )	42 W Pdiss, 128 uS PW, 10% DC	183	°C
Median Lifetime ( $T_M$ )		2.0E9	Hrs
Thermal Resistance ( $\theta_{JC}$ )	85 °C Case	2.46	°C/W
Peak Channel Temperature ( $T_{CH}$ )	52.5 W Pdiss, 128 uS PW, 10% DC	214	°C
Median Lifetime ( $T_M$ )		1.4E8	Hrs
Thermal Resistance ( $\theta_{JC}$ )	85 °C Case	2.59	°C/W
Peak Channel Temperature ( $T_{CH}$ )	63 W Pdiss, 128 uS PW, 10% DC	248	°C
Median Lifetime ( $T_M$ )		9.8E6	Hrs

### Thermal and Reliability Information - CW

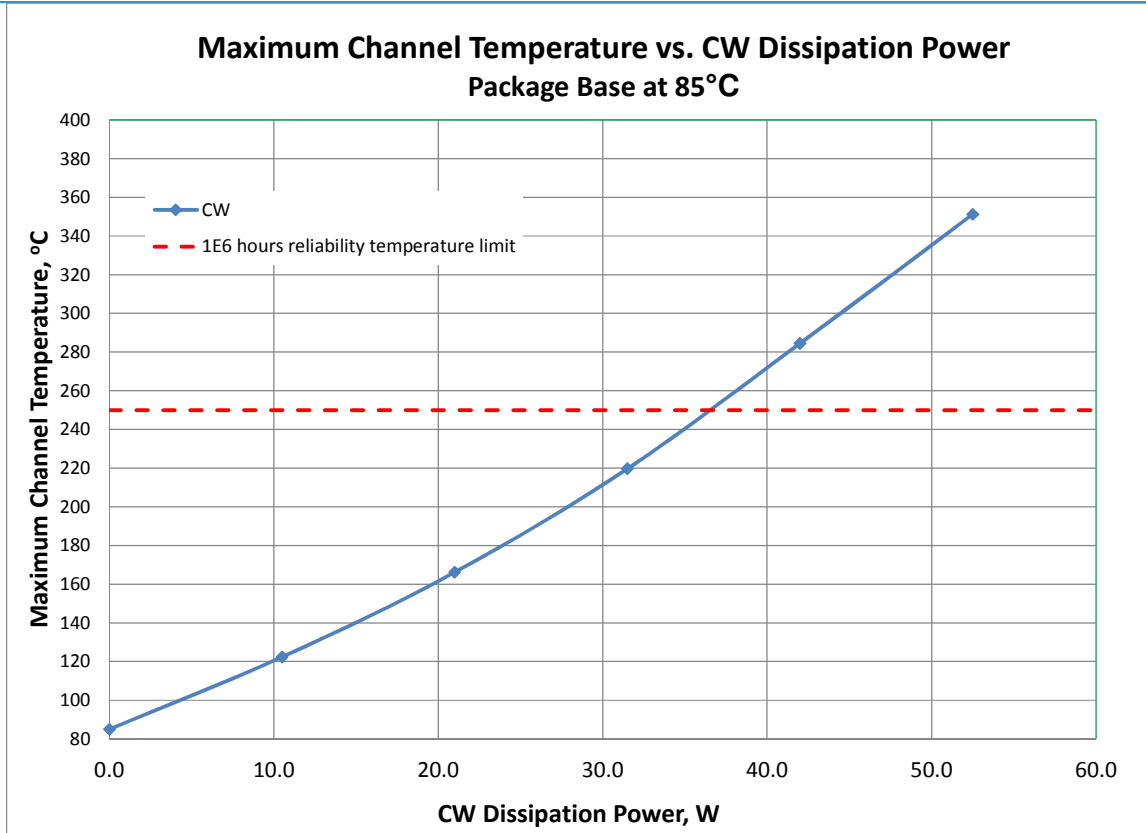

Parameter	Conditions	Values	Units
Thermal Resistance ( $\theta_{JC}$ )	85 °C Case	3.56	°C/W
Maximum Channel Temperature ( $T_{CH}$ )	10.5 W Pdiss, CW	122	°C
Median Lifetime ( $T_M$ )		1.4E11	Hrs
Thermal Resistance ( $\theta_{JC}$ )	85 °C Case	3.86	°C/W
Maximum Channel Temperature ( $T_{CH}$ )	21 W Pdiss, CW	166	°C
Median Lifetime ( $T_M$ )		1.1E9	Hrs
Thermal Resistance ( $\theta_{JC}$ )	85 °C Case	4.28	°C/W
Maximum Channel Temperature ( $T_{CH}$ )	31.5 W Pdiss, CW	220	°C
Median Lifetime ( $T_M$ )		8.3E6	Hrs
Thermal Resistance ( $\theta_{JC}$ )	85 °C Case	4.75	°C/W
Maximum Channel Temperature ( $T_{CH}$ )	42 W Pdiss, CW	285	°C
Median Lifetime ( $T_M$ )		7.8E4	Hrs

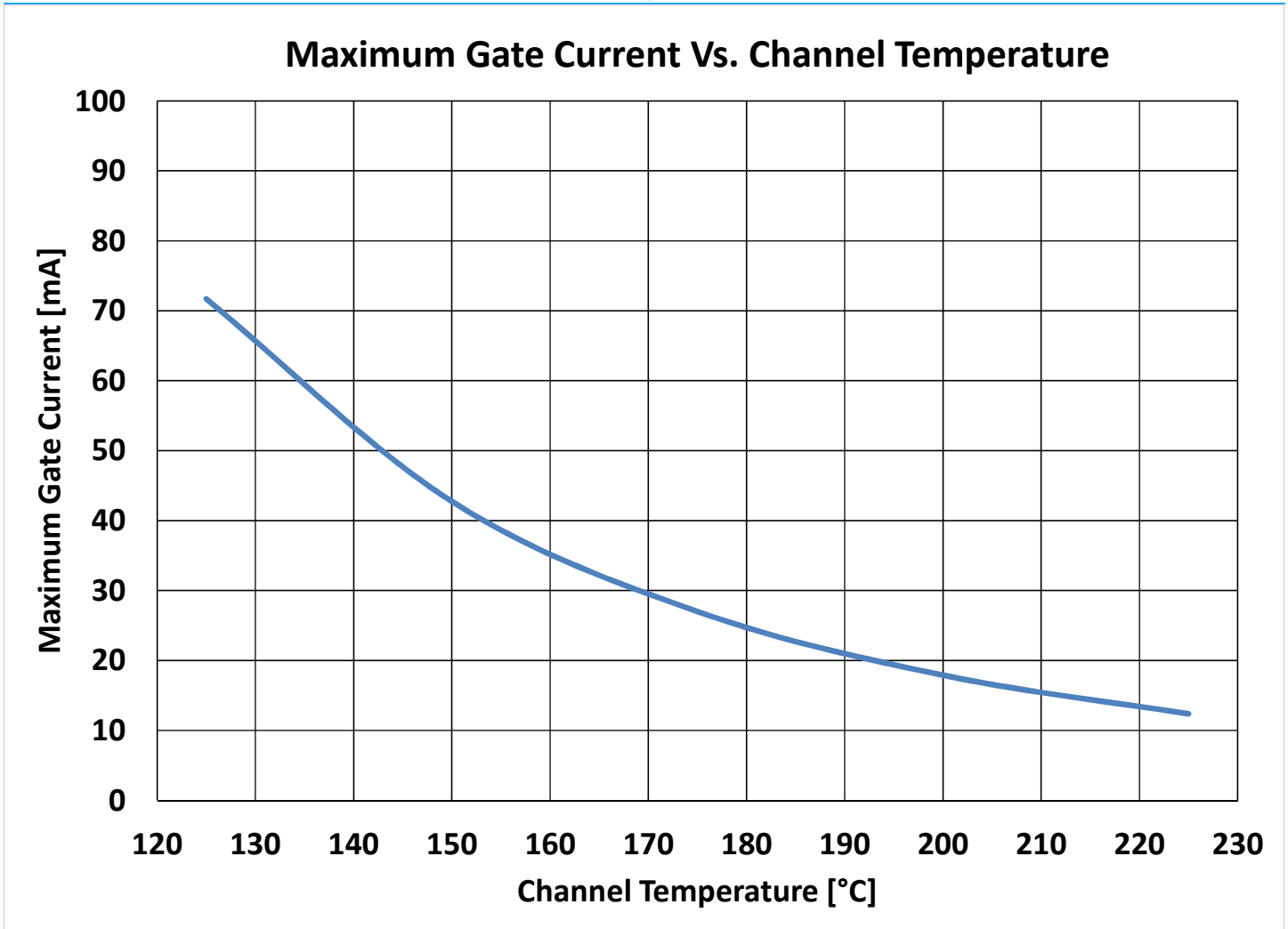
**Maximum Gate Current Vs. Channel Temperature**

### Load-Pull Smith Charts<sup>1, 2, 3</sup>

Notes:

1. 50 V, 65 mA, Pulsed signal with 128 uS pulse width and 10 % duty cycle. Performance is at indicated input power.
2. See page 17 for load-pull and source-pull reference planes. 11.7-Ω load-pull TRL fixtures are built with 32-mil RO4360G2 material.
3. NaN means the impedances are either undefined or varying in load-pull system.

### 1GHz, Load-pull

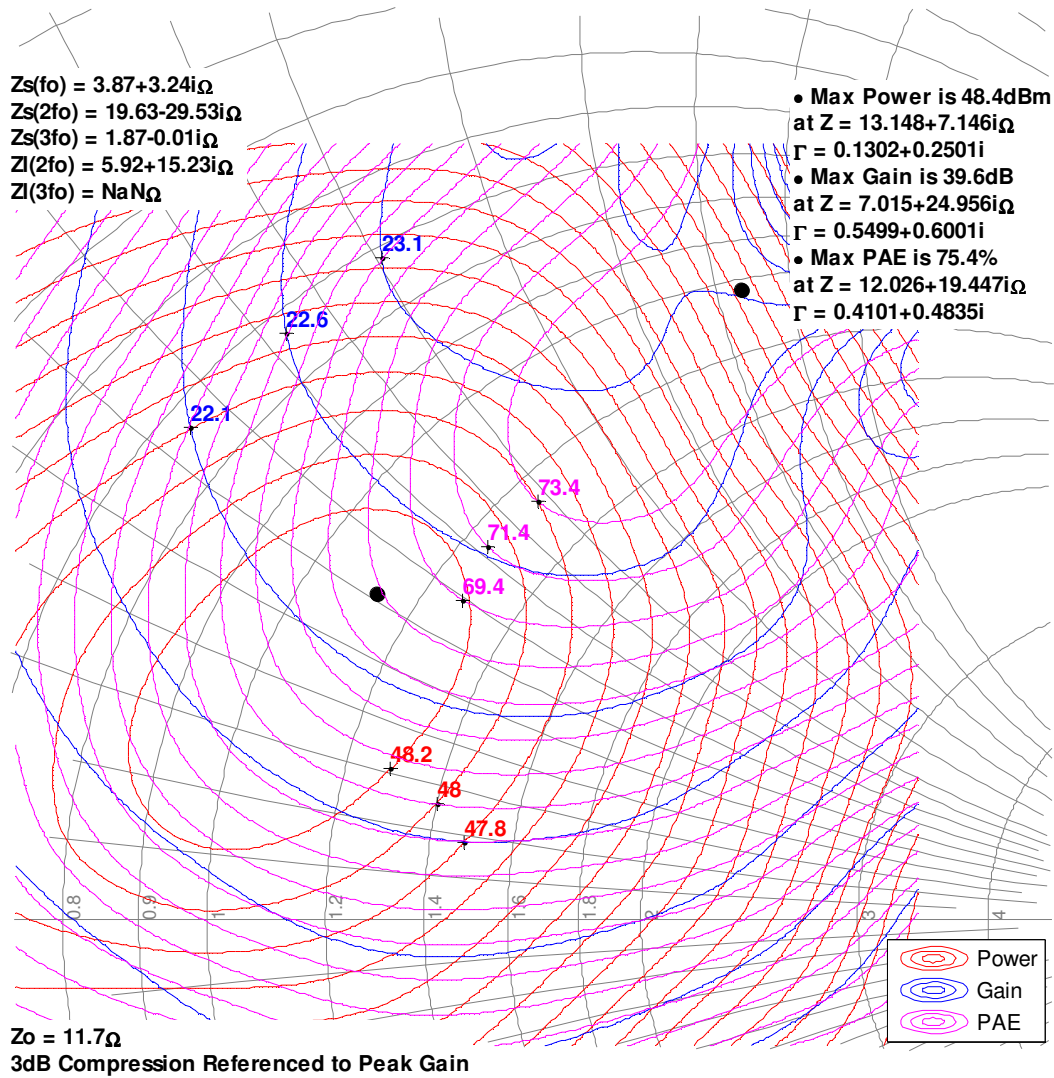



**Load-Pull Smith Charts<sup>1, 2, 3</sup>**

Notes:

1. 50 V, 65 mA, Pulsed signal with 128 uS pulse width and 10 % duty cycle. Performance is at indicated input power.
2. See page 17 for load-pull and source-pull reference planes. 11.7-Ω load-pull TRL fixtures are built with 32-mil RO4360G2 material.
3. NaN means the impedances are either undefined or varying in load-pull system.

**2GHz, Load-pull**

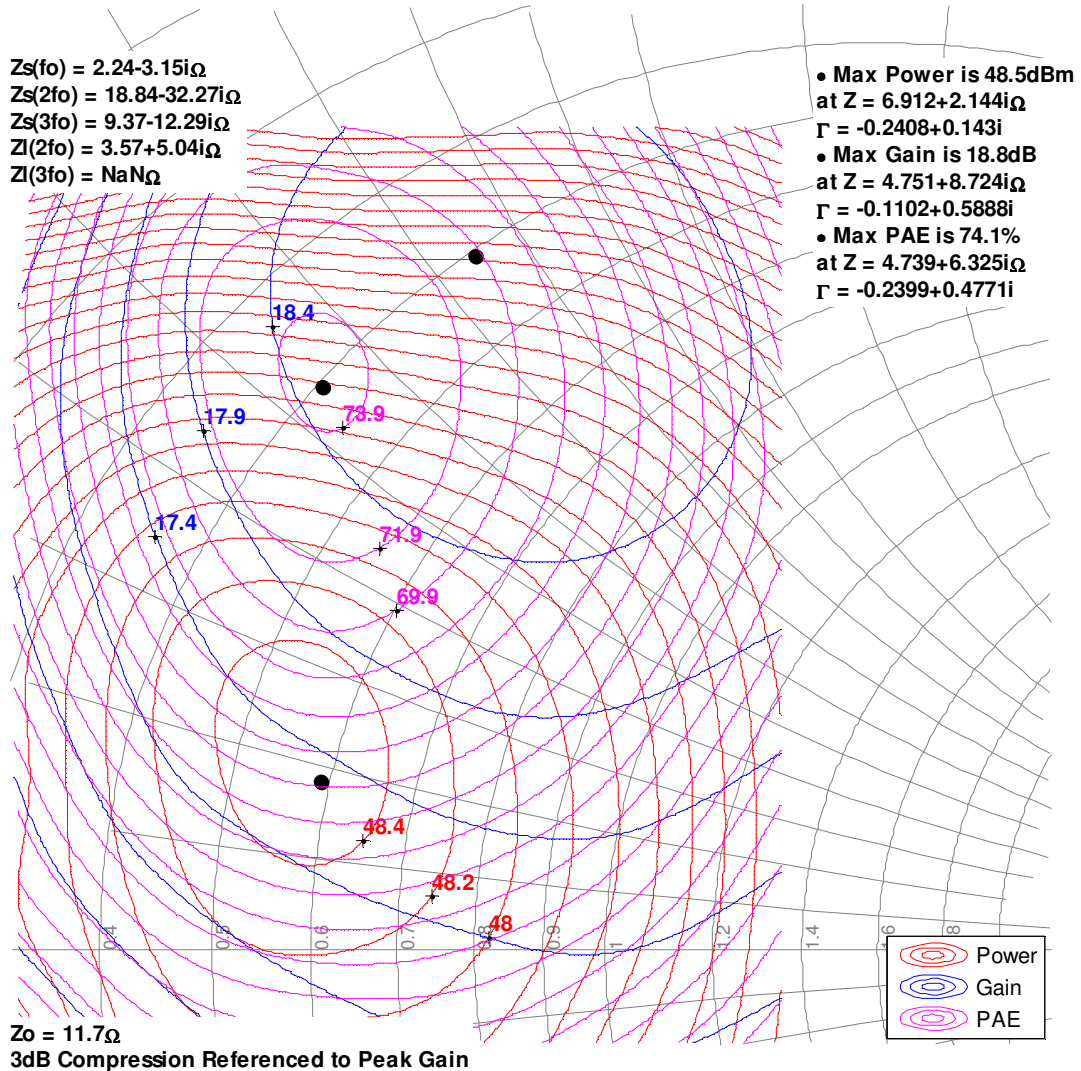

**Load-Pull Smith Charts<sup>1, 2, 3</sup>**

Notes:

1. 50 V, 65 mA, Pulsed signal with 128 uS pulse width and 10 % duty cycle. Performance is at indicated input power.
2. See page 17 for load-pull and source-pull reference planes. 11.7-Ω load-pull TRL fixtures are built with 32-mil RO4360G2 material.
3. NaN means the impedances are either undefined or varying in load-pull system.

**3GHz, Load-pull**

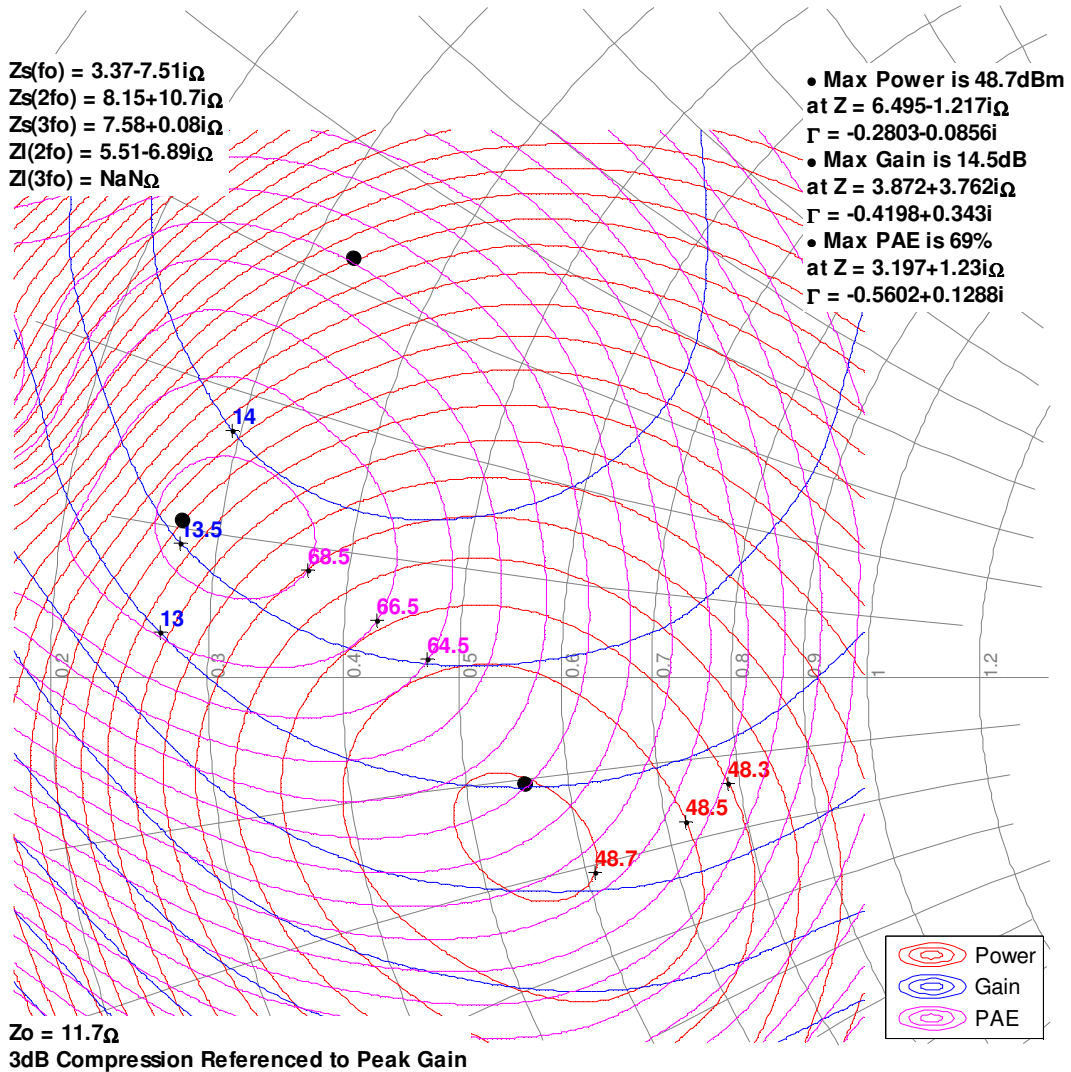

**Load-Pull Smith Charts<sup>1, 2, 3</sup>**

Notes:

1. 50 V, 65 mA, Pulsed signal with 128 uS pulse width and 10 % duty cycle. Performance is at indicated input power.
2. See page 17 for load-pull and source-pull reference planes. 11.7-Ω load-pull TRL fixtures are built with 32-mil RO4360G2 material.
3. NaN means the impedances are either undefined or varying in load-pull system.

**3.5GHz, Load-pull**

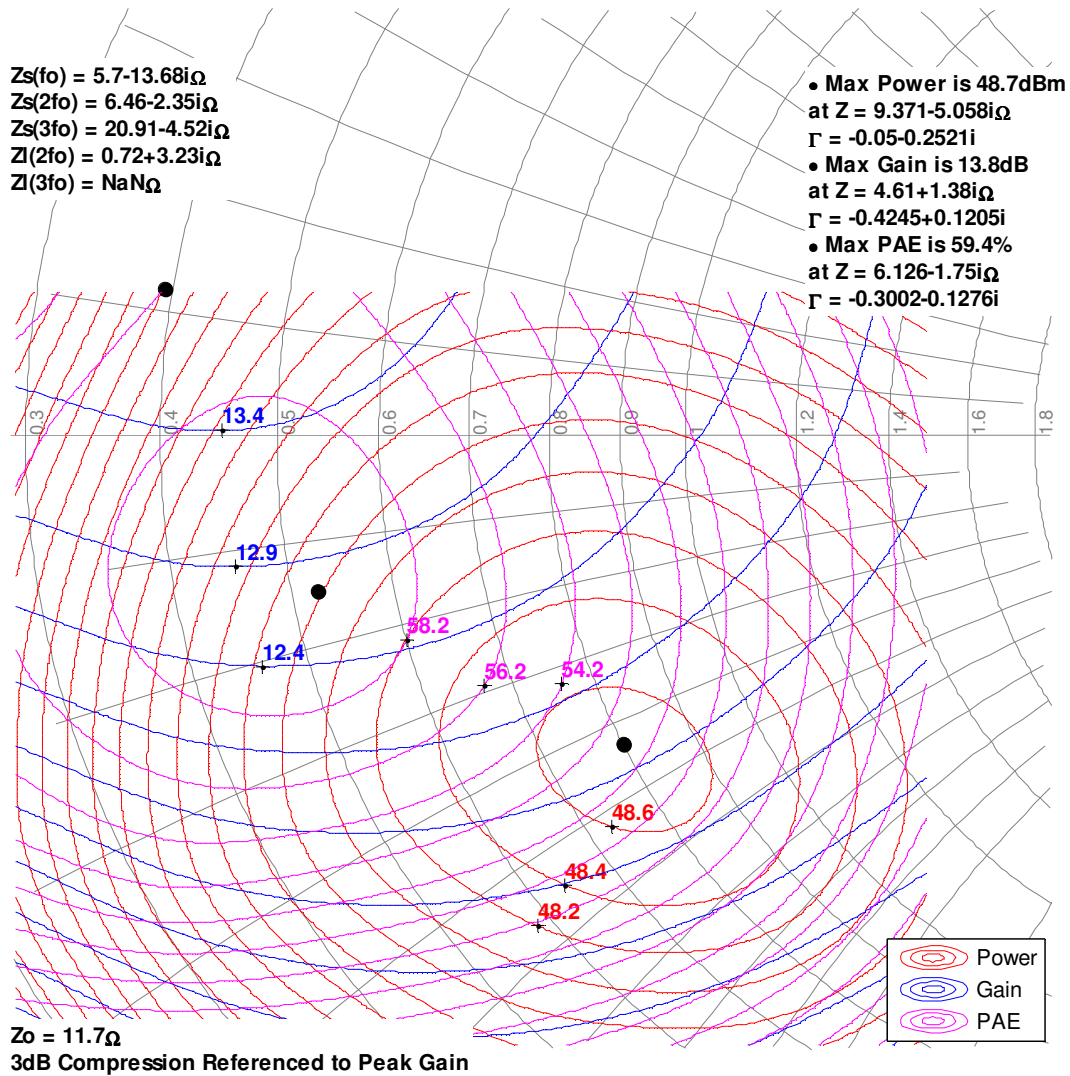

### Typical Performance – Load-Pull Drive-up

Notes:

1. Pulsed signal with 128 uS pulse width and 10 % duty cycle,  $V_d = 50\text{ V}$ ,  $I_{DQ} = 65\text{ mA}$
2. See page 17 for load-pull and source-pull reference planes where the performance was measured.

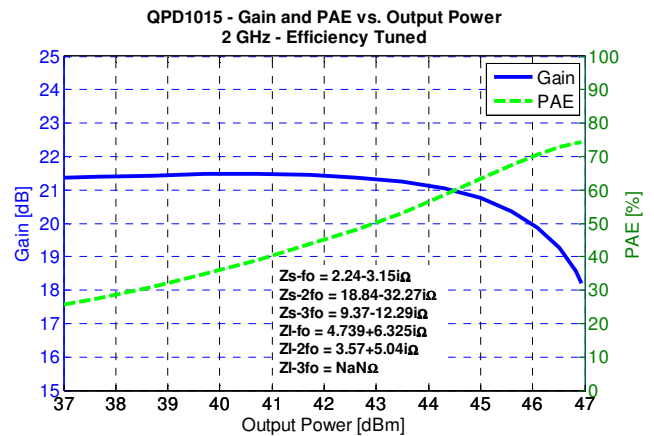
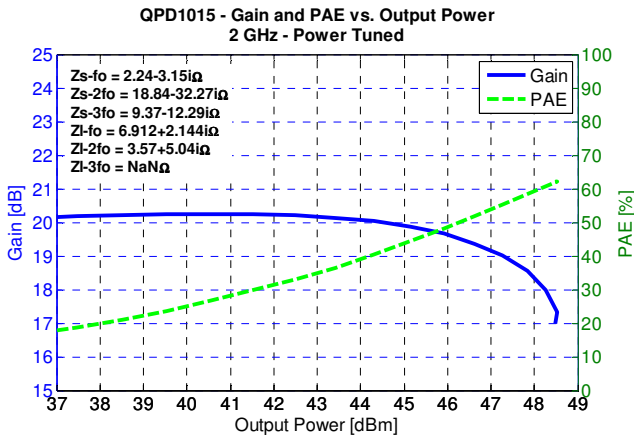
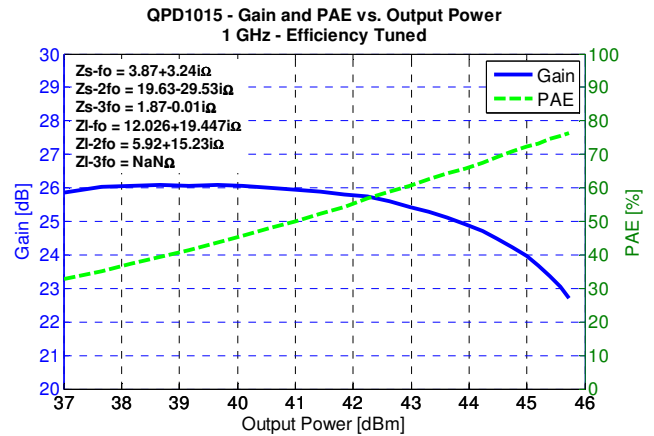
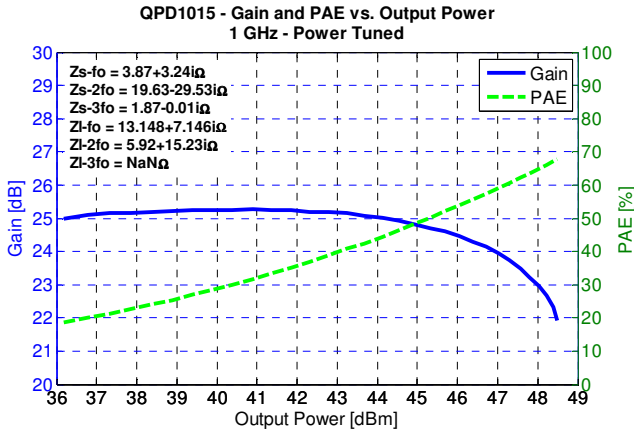

### Typical Performance – Load-Pull Drive-up

Notes:

1. Pulsed signal with 128 uS pulse width and 10 % duty cycle,  $V_d = 50\text{ V}$ ,  $I_{DQ} = 65\text{ mA}$
2. See page 17 for load-pull and source-pull reference planes where the performance was measured.

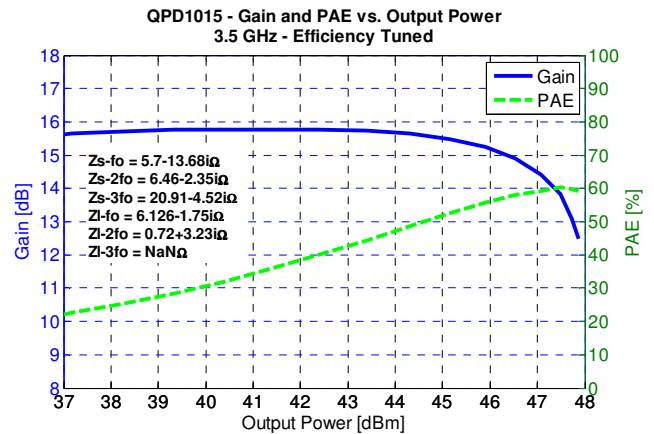
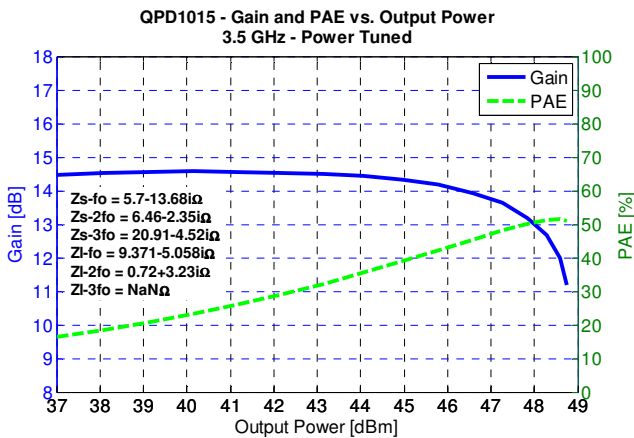
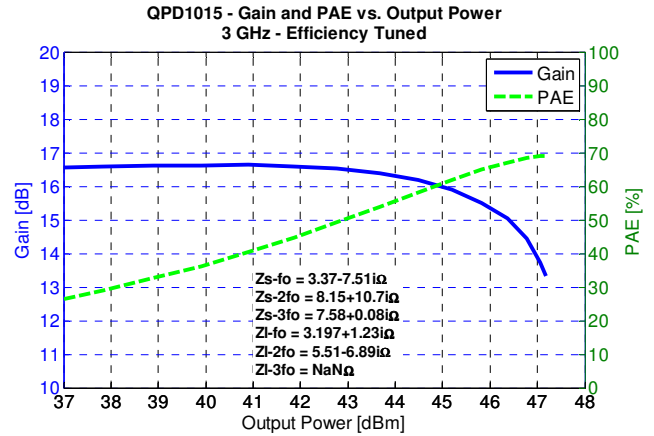
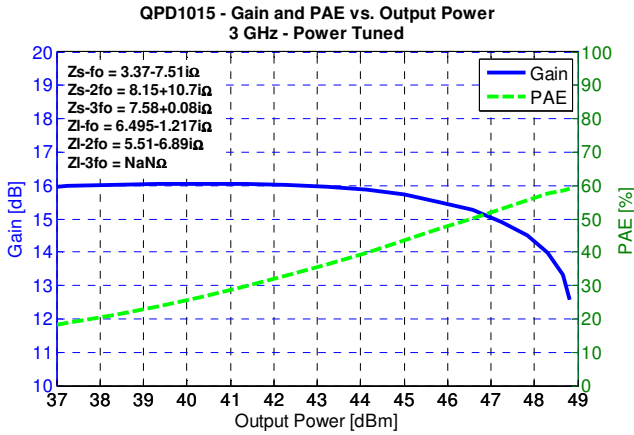

## Typical Performance Over Temperatures – 0.96 – 1.215 GHz EVB<sup>1</sup>

1. Pulsed signal with 128 uS pulse width and 10 % duty cycle,  $V_d = 50\text{ V}$ ,  $I_{DQ} = 65\text{ mA}$

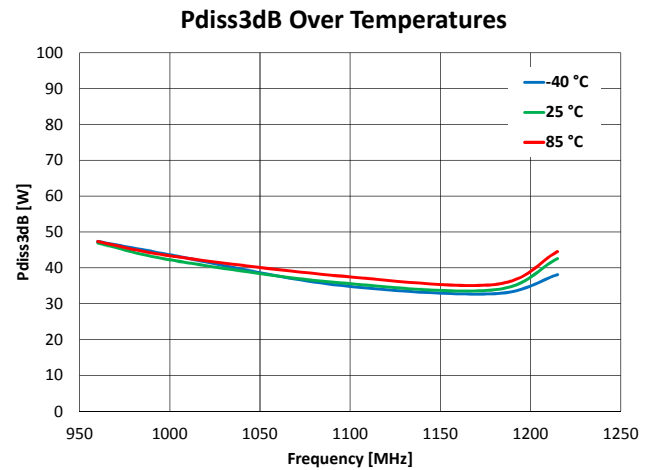
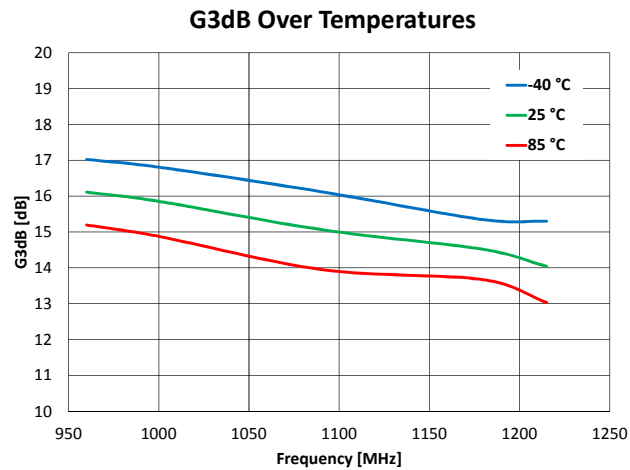
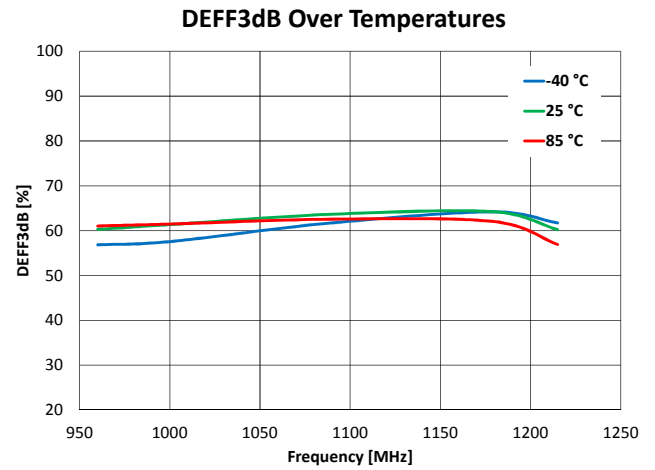
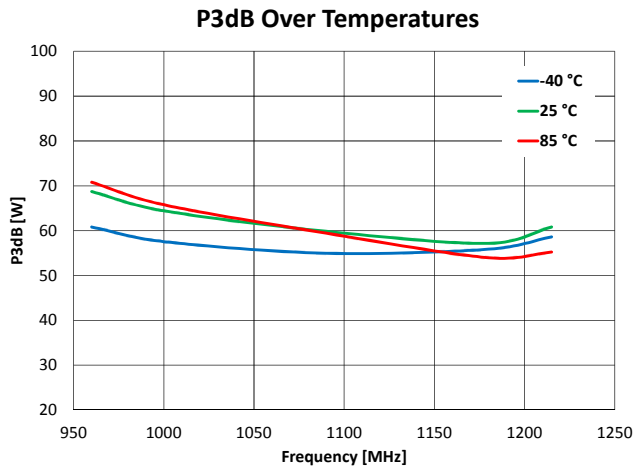

## Typical Performance At 25 °C – 0.96 – 1.215 GHz EVB<sup>1</sup>

1. Pulsed signal with 128 uS pulse width and 10 % duty cycle,  $V_d = 50\text{ V}$ ,  $I_{DQ} = 65\text{ mA}$

**P3dB At 25 °C**

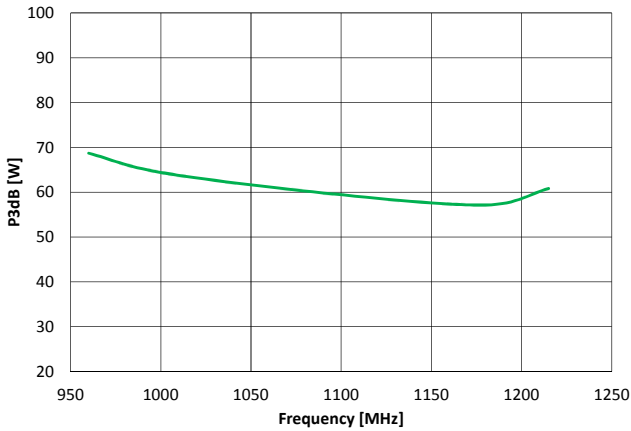

**DEFF3dB At 25 °C**

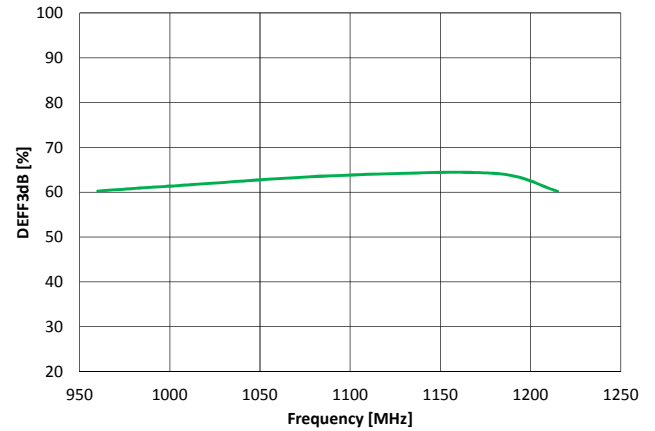

**G3dB At 25 °C**

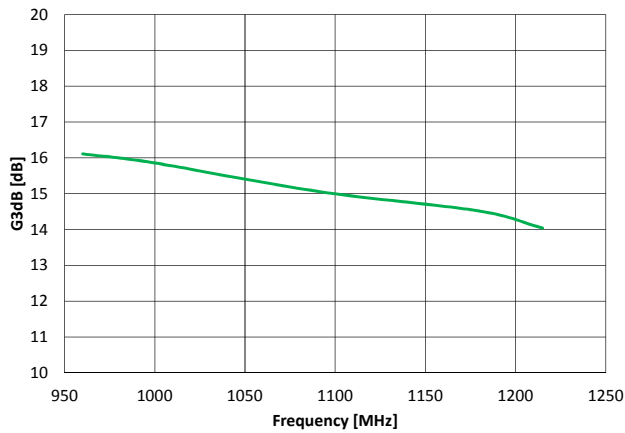

**Pdiss3dB At 25 °C**

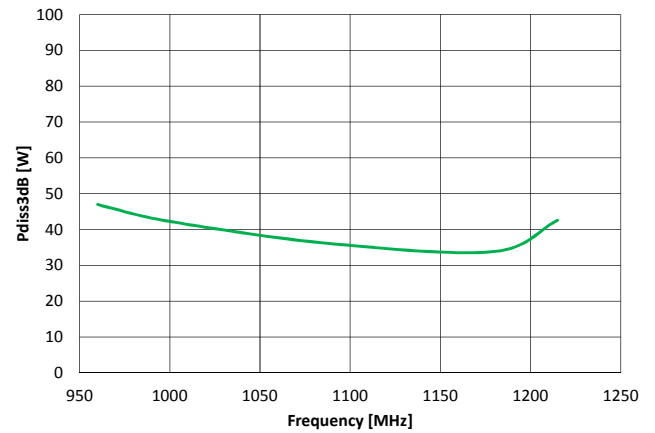

### Typical 2Tone Performance At 25 °C – 0.96 – 1.215 GHz EVB<sup>1</sup>

1. Tone Spacing = 10 MHz, Center frequency = 1.09 GHz

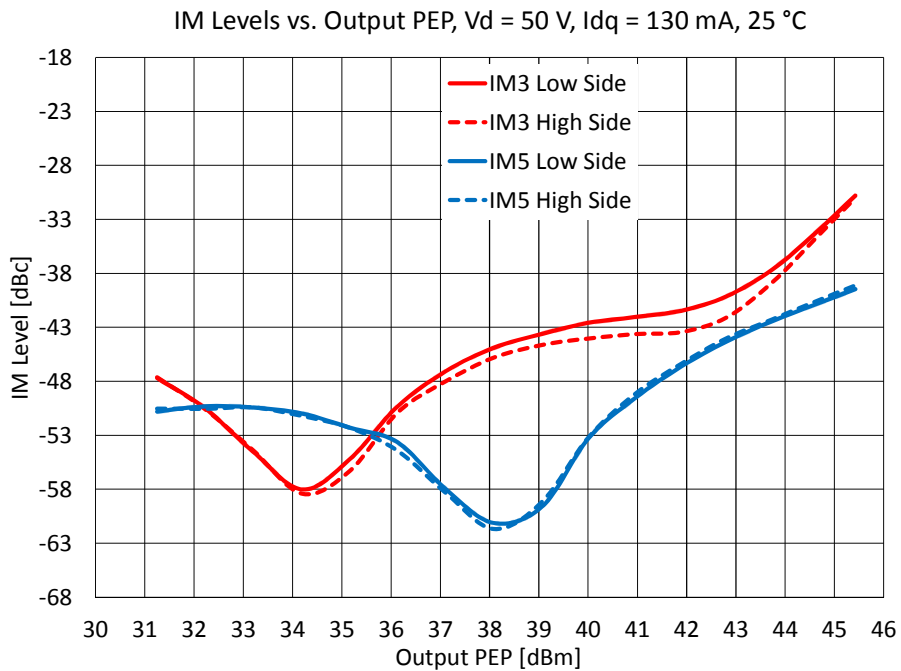
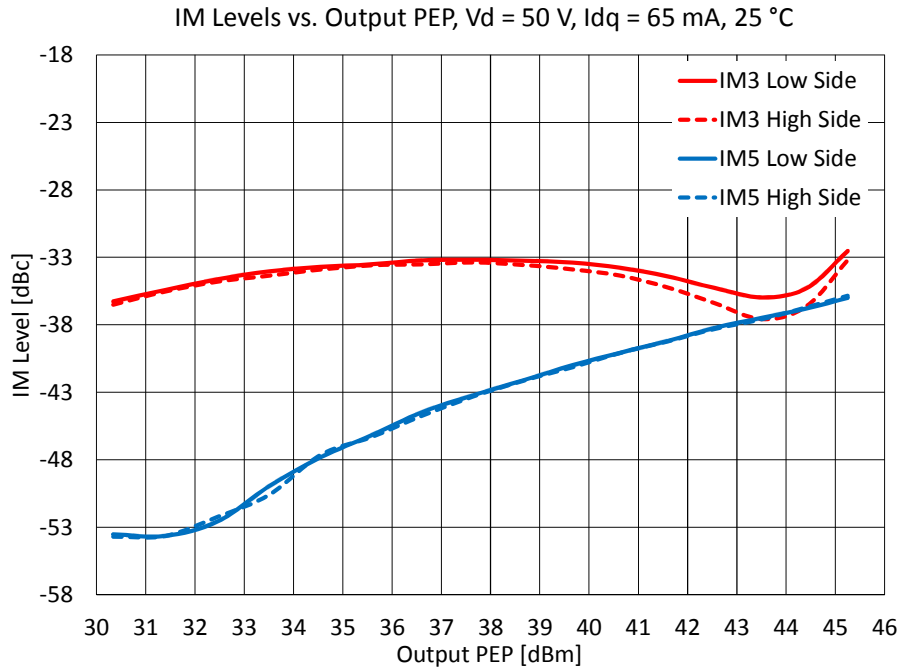



## Typical Performance At 25 °C – 3.0 – 3.5 GHz EVB<sup>1</sup>

1. Pulsed signals,  $V_d = 50\text{ V}$ ,  $I_{DQ} = 65\text{ mA}$

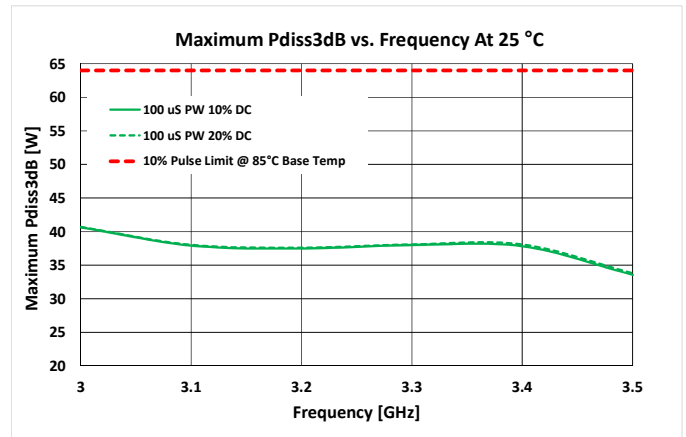
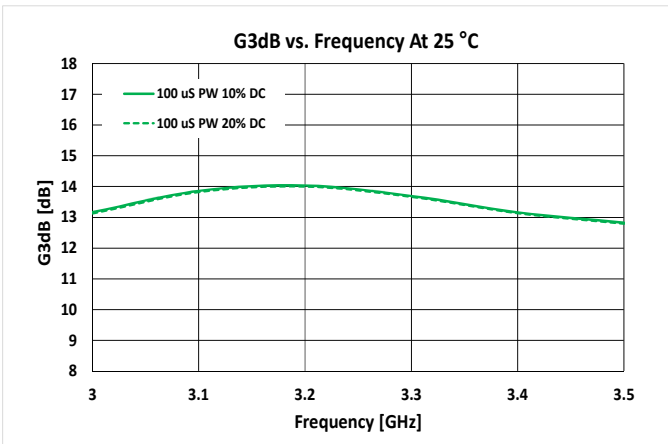
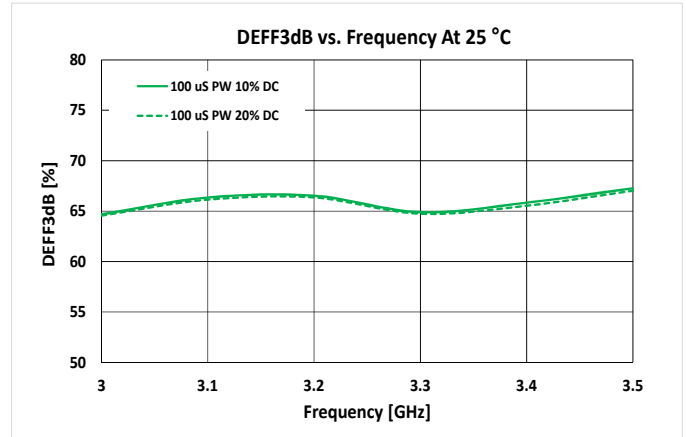
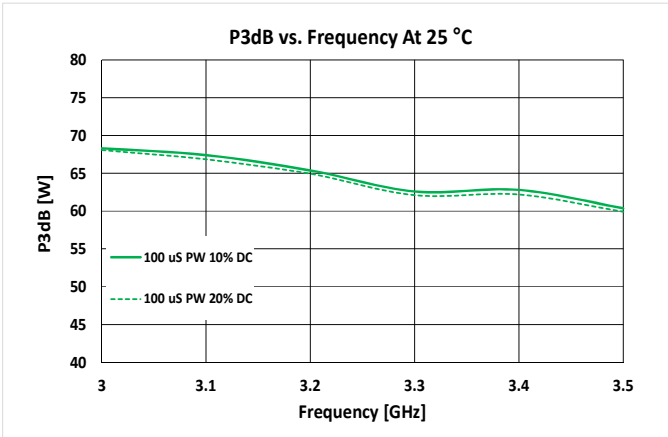

## Pin Layout<sup>1</sup>

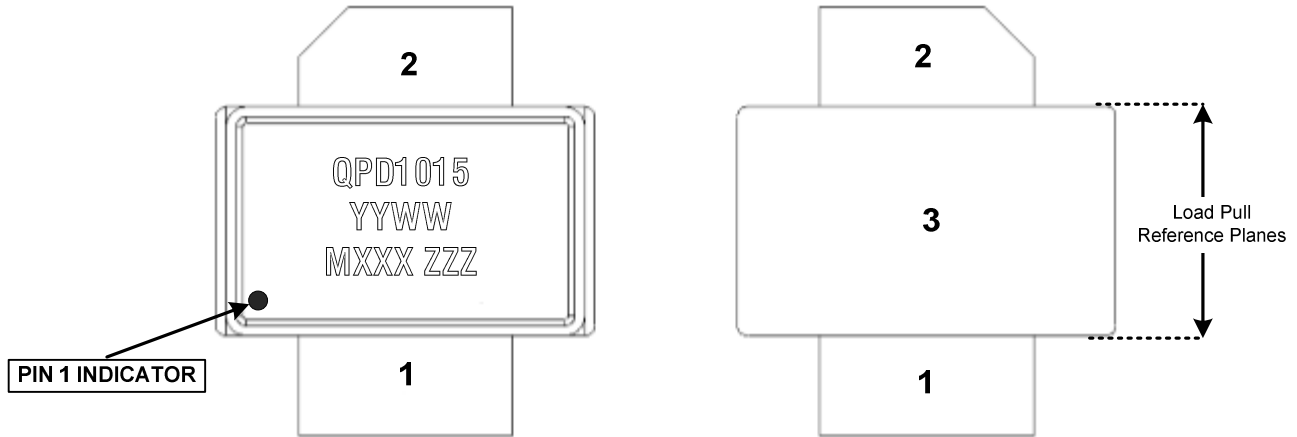

### Notes:

- The QPD1015 will be marked with the “QPD1015” designator and a lot code marked below the part designator. The “YY” represents the last two digits of the calendar year the part was manufactured, the “WW” is the work week of the assembly lot start, the “MXXX” is the production lot number, and the “ZZZ” is an auto-generated serial number.

## Pin Description

Pin	Symbol	Description
1	VG / RF IN	Gate voltage / RF Input
2	VD / RF OUT	Drain voltage / RF Output
3	Flange	Source to be connected to ground

**Mechanical Drawing<sup>1</sup>**

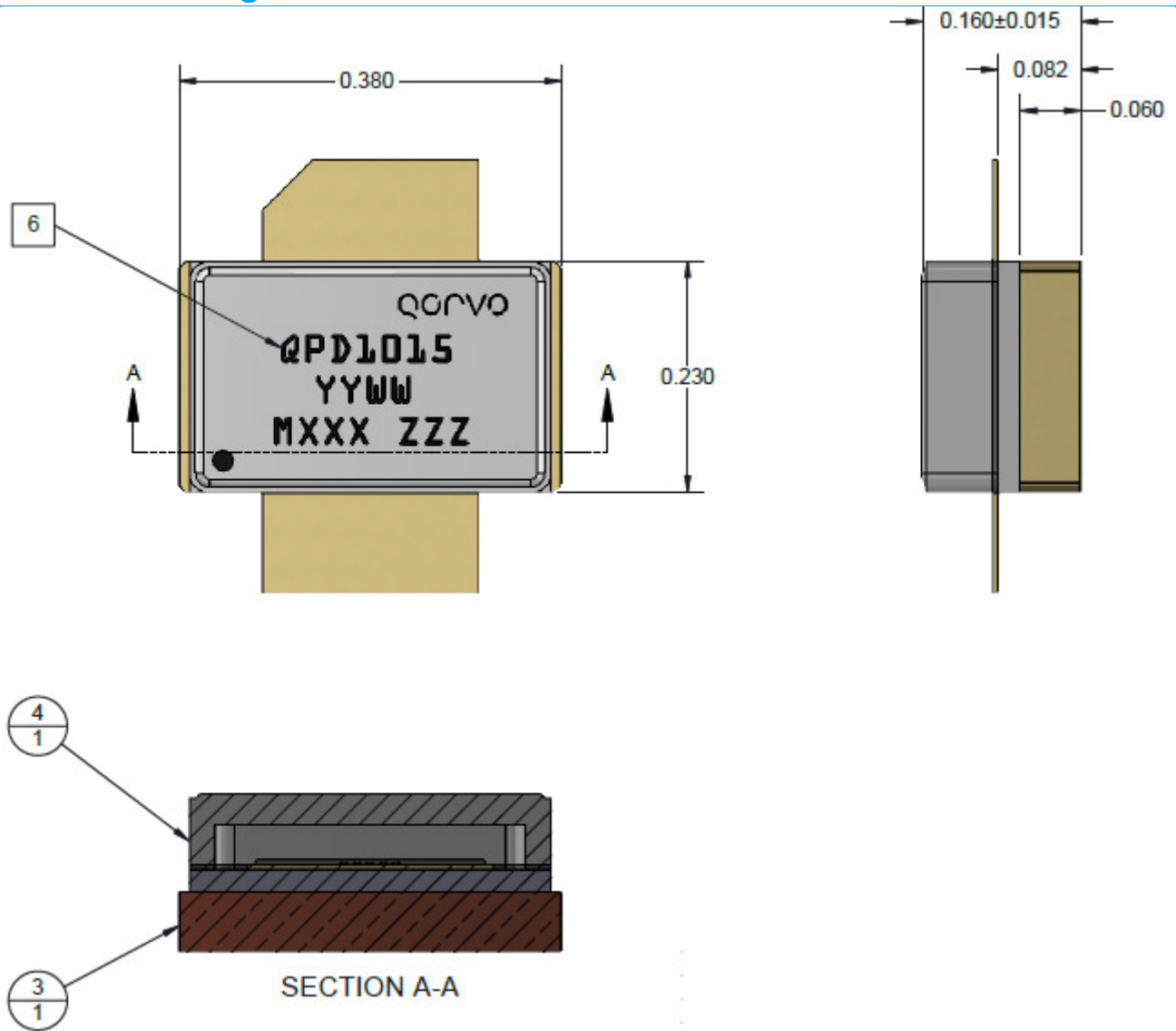

Notes:

1. All dimensions are in inches. Angles are in degrees.

**0.96 – 1.215 GHz Application Circuit - Schematic**

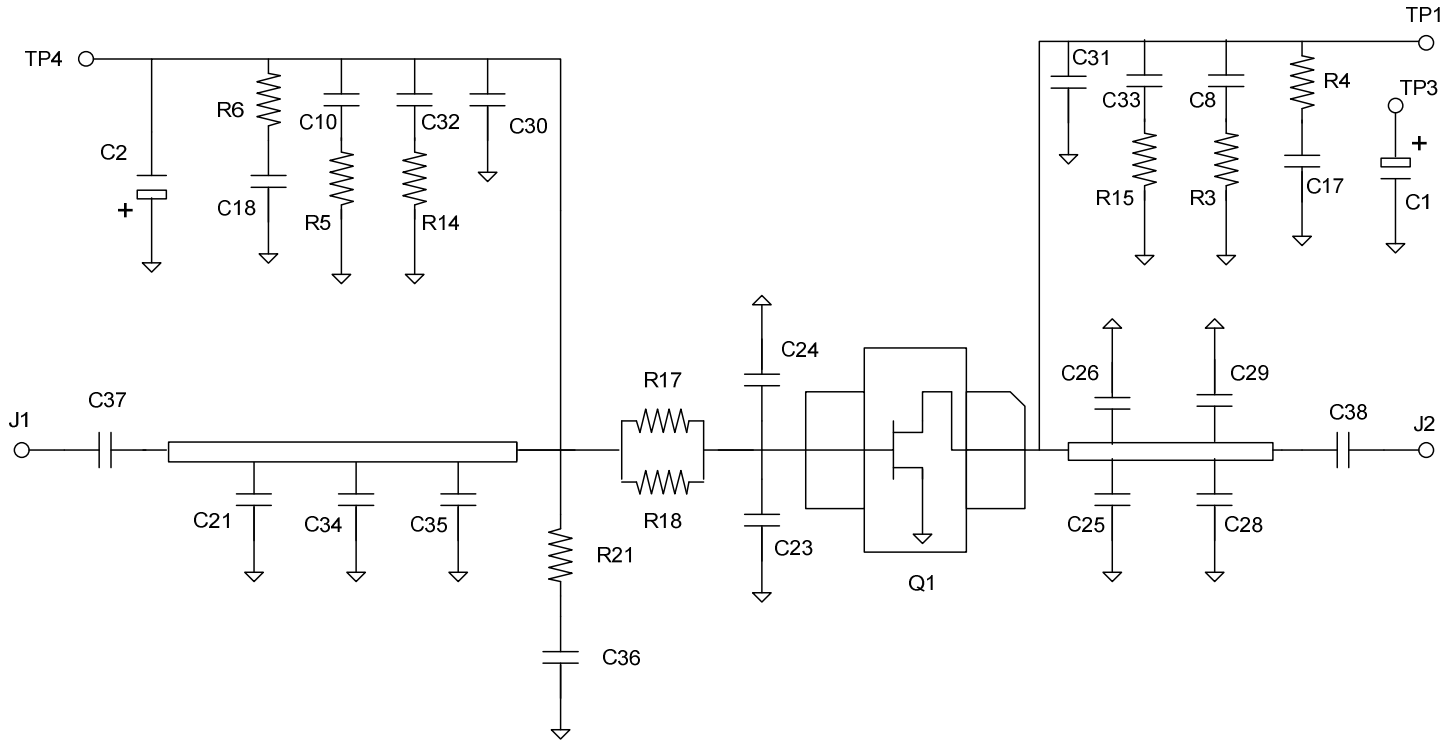

Bias-up Procedure	Bias-down Procedure
1. Set $V_G$ to -4 V.	1. Turn off RF signal.
2. Set $I_D$ current limit to 70 mA.	2. Turn off $V_D$
3. Apply 50 V $V_D$ .	3. Wait 2 seconds to allow drain capacitor to discharge
4. Slowly adjust $V_G$ until $I_D$ is set to 65 mA.	4. Turn off $V_G$
5. Set $I_D$ current limit to 0.3 A (Pulsed operation)	
6. Apply RF.	

## 0.96 – 1.215 GHz Application Circuit - Layout

Board material is RO4360G2 0.032" thickness with 1 oz copper cladding.

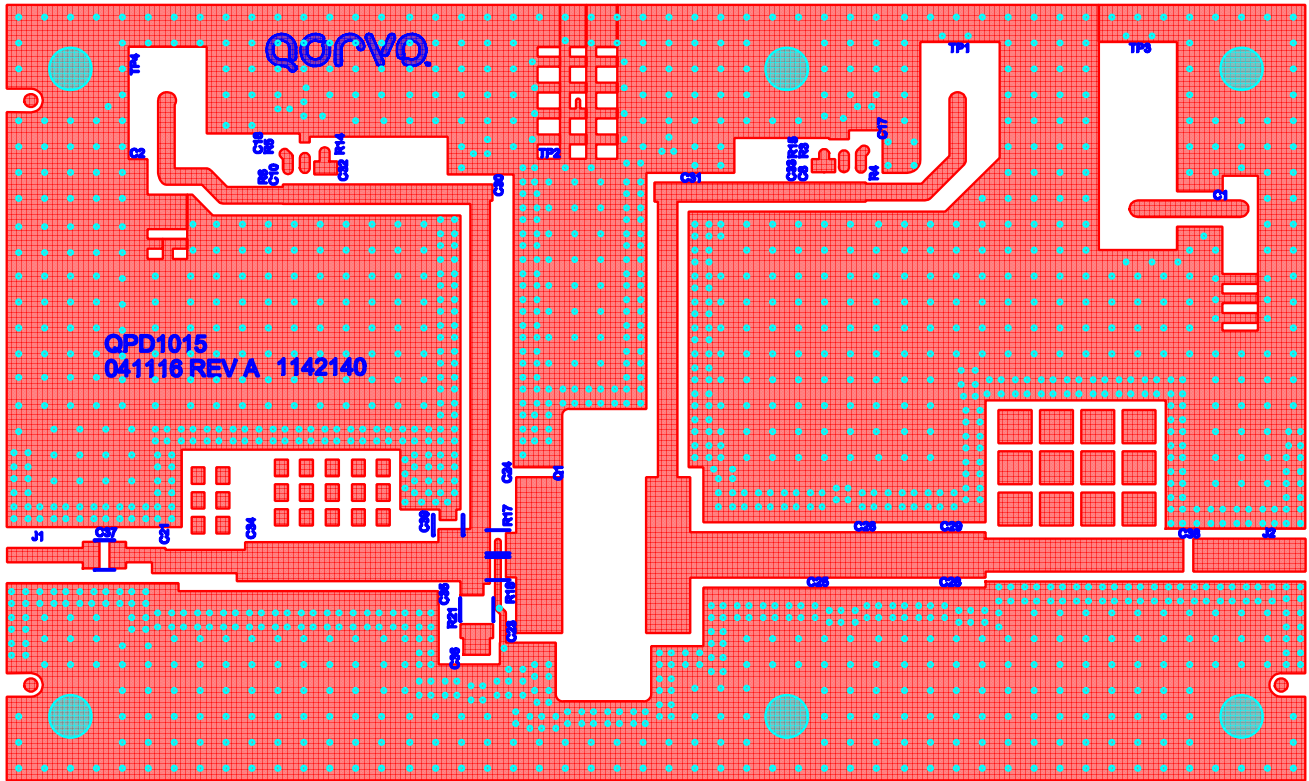

### 0.96 – 1.215 GHz Application Circuit - Bill Of material

Ref Des	Value	Description	Manufacturer	Part Number
C8, 10	1 nF	X7R 100V 5% 0603 Capacitor	AVX	06031C102JAT2A
C17 - 18	100 nF	X7R 100V 5% 0805 Capacitor	AVX	08051C104JAT2A
C28 - 29	0.4 pF	RF NPO 250VDC ± 0.1 pF Capacitor	ATC	ATC800A2R0BT250X
C23 – 24	1.0 pF	RF NPO 250VDC ± 0.1 pF Capacitor	ATC	ATC800A2R4BT250X
C21	1.3 pF	RF NPO 250VDC ± 0.1 pF Capacitor	ATC	ATC800A3R0BT250X
C25 – 26	2.7 pF	RF NPO 250VDC ± 0.1 pF Capacitor	ATC	ATC800A6R2BT250X
C34	3.6 pF	RF NPO 250VDC ± 0.1 pF Capacitor	ATC	ATC800A3R6BT250X
C35	11 pF	RF NPO 250VDC 1% Capacitor	ATC	ATC800A110FT250X
C30 – 31, 36 - 38	56 pF	RF NPO 250VDC 1% Capacitor	ATC	ATC800A560FT250X
C32 – 33	100 pF	RF NPO 250VDC 1% Capacitor	ATC	ATC800A101FT250X
C1	33 uF	SVP Capacitor	SANYO	63SXV33M
C2	10 uF	Tantalum Capacitor	AVX	TPSC106KR0500
J1 - 2		SMA Panel Mount 4-hole Jack	Gigalane	PSF-S00-000
L1	5.6 nH	0805 5% Inductor	COILCRAFT	0805CS-050XJE
R4, 6	1 Ohm	0603 Thick Film Resistor	ANY	
R5	3.3 Ohm	0603 Thick Film Resistor	ANY	
R14 – 15	5.1 Ohm	0603 Thick Film Resistor	ANY	
R3	33 Ohm	0603 Thick Film Resistor	ANY	
R21	24 Ohm	0805 Thick Film Resistor	Panasonic	ERJ-14YJ240
R17 – 18	4 Ohm	0805CS High Power Thick Film Resistor	IMS	ND3-0805CS4R00J

## 3.0 – 3.5 GHz Application Circuit - Schematic

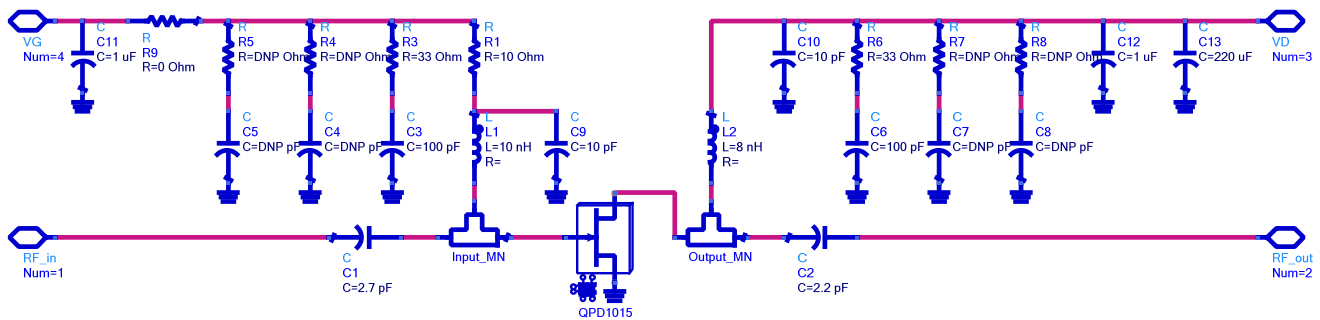

Bias-up Procedure	Bias-down Procedure
2. Set $V_G$ to -4 V.	3. Turn off RF signal.
4. Set $I_D$ current limit to 70 mA.	4. Turn off $V_D$
5. Apply 50 V $V_D$ .	5. Wait 2 seconds to allow drain capacitor to discharge
6. Slowly adjust $V_G$ until $I_D$ is set to 65 mA.	7. Turn off $V_G$
8. Set $I_D$ current limit to 0.3 A (Pulsed operation)	
9. Apply RF.	

## 3.0 – 3.5 GHz Application Circuit - Layout

Board material is RO6010 0.025" thickness with 1 oz copper cladding. Overall size is 2" x 2".

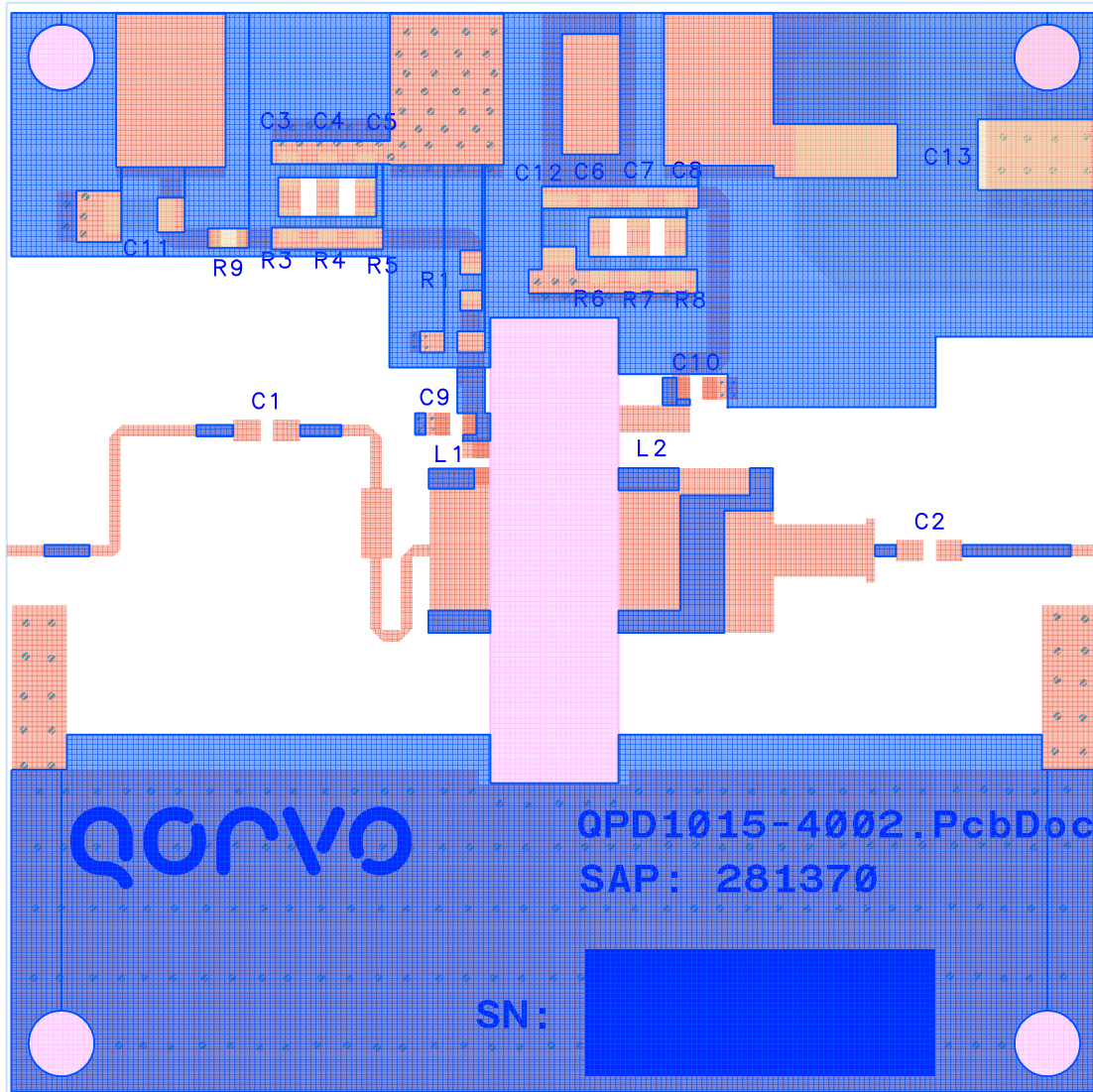



### 3.0 – 3.5 GHz Application Circuit - Bill Of material

Ref Des	Value	Description	Manufacturer	Part Number
C1, C9, C10	2.7 pF	RF NPO 250VDC ± 0.1 pF Capacitor	ATC	600S2R7AW250XT
C2	2.2 pF	RF NPO 250VDC ± 0.1 pF Capacitor	ATC	600S2R2AW250XT
C8, C6	100 pF	RF NPO 250VDC ± 0.1 pF Capacitor	Capax Tech.	0603G101J201S
C11	1.0 uF	16VDC 1206 Capacitor	TTI	C1206C105K4RACTU
C12	0.1 uF	100VDC 1206 Capacitor	TDK	C3216X7R2A104K160AA
C13	220 uF	63VDC Electrolytic Capacitor	Panasonic	EEVTG1J221Q
L1	10 nH	0603 RF Inductor	CoilCraft	0603CS-10NXJEW
L2	8 nH	RF Air-core Choke	CoilCraft	A03T
R1	10 Ohm	0603 Thick-film resistor	Vishay	CRCW060310R0JNTA
R8, R6	33 Ohm	0603 Thick-film resistor	Vishay	CRCW060333R2FKTA
R9	0 Ohm	0603 Thick-film resistor	TTI	CRCW06030000Z0EA
C3, C4, C5, C6, C7, R3, R4, R5, R6, R7		Not populated		
J1 - 2		SMA Panel Mount 4-hole Jack	Gigalane	PSF-S00-000

**Recommended Solder Temperature Profile**

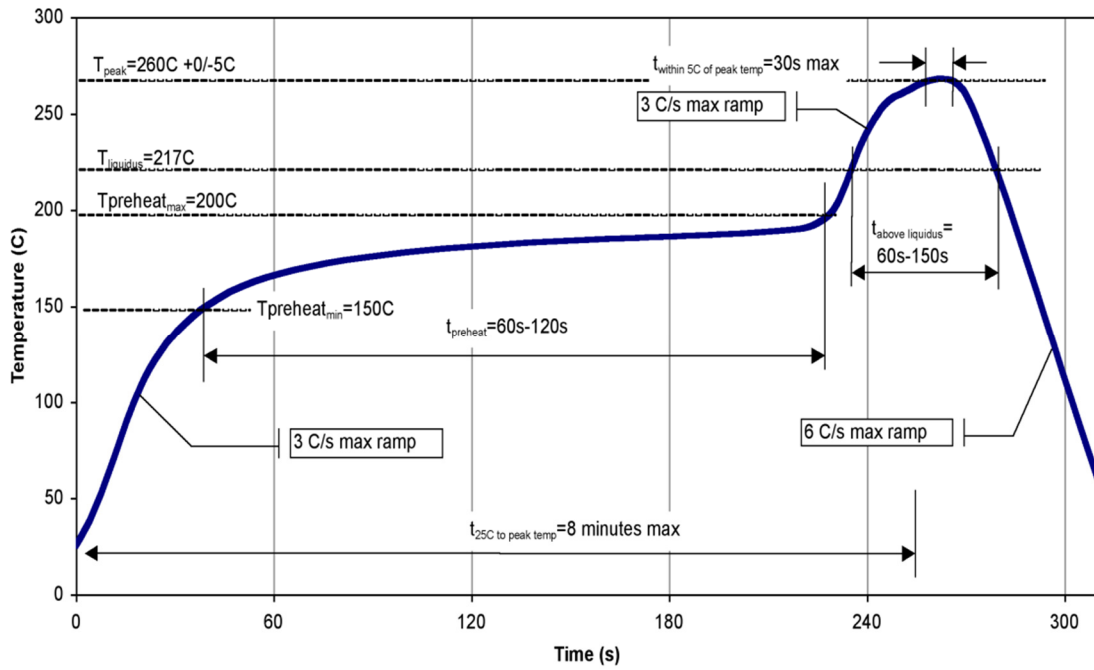

### Product Compliance Information

---

#### ESD Sensitivity Ratings



Caution! ESD Sensitive Device

#### ESD Rating

ESD Rating: Class 1A  
Value: 250 V  
Test: Human Body Model (HBM)  
Standard: JEDEC Standard JESD22-A114

#### MSL Rating

MSL Rating: MSL3  
Test: 260 °C convection reflow  
Standard: JEDEC Standard IPC/JEDEC J-STD-020

#### Solderability

Compatible with lead free soldering processes, 260 °C maximum reflow temperature.

Package lead plating: NiAu

The use of no-clean solder to avoid washing after soldering is recommended.

This part is compliant with EU 2002/95/EC RoHS directive (Restrictions on the Use of Certain Hazardous Substances in Electrical and Electronic Equipment).

This product also has the following attributes:

- Lead Free
- Halogen Free (Chlorine, Bromine)
- Antimony Free
- TBBP-A (C<sub>15</sub>H<sub>12</sub>Br<sub>4</sub>O<sub>2</sub>) Free
- PFOS Free
- SVHC Free

### Contact Information

---

For the latest specifications, additional product information, worldwide sales and distribution locations, and information about Qorvo:

Web: [www.Qorvo.com](http://www.Qorvo.com)  
Email: [info-sales@tgs.com](mailto:info-sales@tgs.com)

Tel: +1.972.994.8465  
Fax: +1.972.994.8504

For technical questions and application information: Email: [info-networks@tgs.com](mailto:info-networks@tgs.com)

### Important Notice

---

The information contained herein is believed to be reliable. Qorvo makes no warranties regarding the information contained herein. Qorvo assumes no responsibility or liability whatsoever for any of the information contained herein. Qorvo assumes no responsibility or liability whatsoever for the use of the information contained herein. The information contained herein is provided "AS IS, WHERE IS" and with all faults, and the entire risk associated with such information is entirely with the user. All information contained herein is subject to change without notice. Customers should obtain and verify the latest relevant information before placing orders for Qorvo products. The information contained herein or any use of such information does not grant, explicitly or implicitly, to any party any patent rights, licenses, or any other intellectual property rights, whether with regard to such information itself or anything described by such information.

Qorvo products are not warranted or authorized for use as critical components in medical, life-saving, or life-sustaining applications, or other applications where a failure would reasonably be expected to cause severe personal injury or death.

## X-ON Electronics

Largest Supplier of Electrical and Electronic Components

*Click to view similar products for [RF Development Tools](#) category:*

*Click to view products by [Qorvo](#) manufacturer:*

Other Similar products are found below :

[MAAM-011117](#) [MAAP-015036-DIEEV2](#) [EV1HMC1113LP5](#) [EV1HMC6146BLC5A](#) [EV1HMC637ALP5](#) [EVAL-ADG919EBZ](#) [ADL5363-EVALZ](#) [LMV228SDEVAL](#) [SKYA21001-EVB](#) [SMP1331-085-EVB](#) [EV1HMC618ALP3](#) [EVAL01-HMC1041LC4](#) [MAAL-011111-000SMB](#) [MAAM-009633-001SMB](#) [MASW-000936-001SMB](#) [107712-HMC369LP3](#) [107780-HMC322ALP4](#) [SP000416870](#) [EV1HMC470ALP3](#) [EV1HMC520ALC4](#) [EV1HMC244AG16](#) [MAX2614EVKIT#](#) [124694-HMC742ALP5](#) [SC20ASATEA-8GB-STD](#) [MAX2837EVKIT+](#) [MAX2612EVKIT#](#) [MAX2692EVKIT#](#) [EV1HMC629ALP4E](#) [SKY12343-364LF-EVB](#) [108703-HMC452QS16G](#) [EV1HMC863ALC4](#) [EV1HMC427ALP3E](#) [119197-HMC658LP2](#) [EV1HMC647ALP6](#) [ADL5725-EVALZ](#) [MAX2371EVKIT#](#) [106815-HMC441LM1](#) [EV1HMC1018ALP4](#) [UXN14M9PE](#) [MAX2016EVKIT](#) [EV1HMC939ALP4](#) [MAX2410EVKIT](#) [MAX2204EVKIT+](#) [EV1HMC8073LP3D](#) [SIMSA868-DKL](#) [SIMSA868C-DKL](#) [SKY65806-636EK1](#) [SKY68020-11EK1](#) [SKY67159-396EK1](#) [SKY66181-11-EK1](#)