

### Product Overview

The Qorvo QPD1016 is a 500 W ( $P_{3dB}$ ) pre-matched discrete GaN on SiC HEMT which operates from DC to 1.7 GHz and 50 V supply. The device is in an industry standard air cavity package and is ideally suited for IFF, avionics, military and civilian radar, and test instrumentation. The device can support pulsed and linear operations.

ROHS compliant.

Evaluation boards are available upon request.

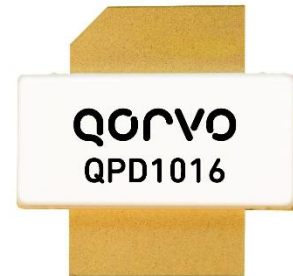

NI-780 Package

### Functional Block Diagram

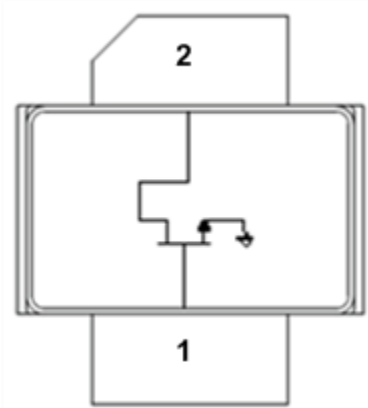

### Key Features

- Frequency: DC to 1.7 GHz
  - Output Power ( $P_{3dB}$ )<sup>1</sup>: 680 W
  - Linear Gain<sup>1</sup>: 23.9 dB
  - Typical PAE<sub>3dB</sub><sup>1</sup>: 77.4%
  - Operating Voltage: 50 V
  - CW and Pulse capable
- Note 1: @ 1.3 GHz Load Pull

### Applications

- IFF
- Avionics
- Military and civilian radar
- Test instrumentation

Part No.	Description
QPD1016	DC – 1.7 GHz, 50 V, 500 W GaN RF Transistor
QPD1016EVB01	1.2 – 1.4 GHz EVB



**Absolute Maximum Ratings<sup>1</sup>**

Parameter	Rating	Units
Breakdown Voltage, $V_{BDG}$	+145	V
Gate Voltage Range, $V_G$	-7 to +1.5	V
Drain Current, $I_{D_{MAX}}$	70	A
Gate Current Range, $I_G$	See page 17.	mA
Power Dissipation, $P_{DISS}$	714 <sup>2</sup>	W
RF Input Power, Pulse, 1.3 GHz, $T = 25\text{ }^\circ\text{C}^2$	+45.5	dBm
Mounting Temperature (30 Seconds)	320	$^\circ\text{C}$
Storage Temperature	-65 to +150	$^\circ\text{C}$

Notes:

1. Operation of this device outside the parameter ranges given above may cause permanent damage.
2. Pulsed 300uS PW, 10% DC

**Recommended Operating Conditions<sup>1</sup>**

Parameter	Min	Typ	Max	Units
Operating Temp. Range	-40	+25	+85	$^\circ\text{C}$
Drain Voltage Range, $V_D$	+32	+50	+55	V
Drain Bias Current, $I_{DQ}$		1000		mA
Drain Current, $I_D^4$	-	16	-	A
Gate Voltage, $V_G^3$	-	-2.8	-	V
Power Dissipation ( $P_D$ ) <sup>2,4</sup>	-	-	441	W
Power Dissipation ( $P_D$ ), CW <sup>2</sup>	-	-	269	W

Notes:

1. Electrical performance is measured under conditions noted in the electrical specifications table. Specifications are not guaranteed over all recommended operating conditions.
2. Package base at 85  $^\circ\text{C}$
3. To be adjusted to desired  $I_{DQ}$
4. Pulsed, 300uS PW, 10% DC

**Measured Load Pull Performance – Power Tuned<sup>1</sup>**

Parameter	Typical Values						Units
	1.1	1.2	1.3	1.4	1.5	1.7	
Frequency, F	1.1	1.2	1.3	1.4	1.5	1.7	GHz
Drain Voltage, $V_D$	50	50	50	50	50	50	V
Drain Bias Current, $I_{DQ}$	1000	1000	1000	1000	1000	1000	mA
Output Power at 3dB compression, $P_{3dB}$	58.8	58.6	58.3	58	57.6	58	dBm
Power Added Efficiency at 3dB compression, $PAE_{3dB}$	71.7	69.2	72.2	76.1	69.9	71.2	%
Gain at 3dB compression, $G_{3dB}$	21	20.6	20.9	21.7	21.0	20.6	dB

Notes:

1. Pulsed, 300 uS Pulse Width, 10% Duty Cycle
2. Characteristic Impedance,  $Z_o = 3\ \Omega$ .

**Measured Load Pull Performance – Efficiency Tuned<sup>1</sup>**

Parameter	Typical Values						Units
	1.1	1.2	1.3	1.4	1.5	1.7	
Frequency, F	1.1	1.2	1.3	1.4	1.5	1.7	GHz
Drain Voltage, $V_D$	50	50	50	50	50	50	V
Drain Bias Current, $I_{DQ}$	1000	1000	1000	1000	1000	1000	mA
Output Power at 3dB compression, $P_{3dB}$	57.6	57.1	56.4	57.3	56.1	56.7	dBm
Power Added Efficiency at 3dB compression, $PAE_{3dB}$	79.2	78.3	77.4	77.8	71.2	73.5	%
Gain at 3dB compression, $G_{3dB}$	22.2	22.1	22.2	22.3	21.7	21.7	dB

Notes:

1. Pulsed, 300 uS Pulse Width, 10% Duty Cycle
2. Characteristic Impedance,  $Z_o = 3\ \Omega$ .

### 1.2 – 1.4 GHz EVB 1.3 GHz Performance<sup>1</sup>

Parameter	Min	Typ	Max	Units
Linear Gain, $G_{LIN}$	–	19.6	–	dB
Output Power at 3dB compression point, P3dB	–	550	–	W
Drain Efficiency at 3dB compression point, DEFF3dB	–	70	–	%
Gain at 3dB compression point, G3dB	–	16.6	–	dB

Notes:

1.  $V_D = +50\text{ V}$ ,  $I_{DQ} = 1000\text{ mA}$ , Temp =  $+25\text{ }^\circ\text{C}$ , Pulse Width = 300  $\mu\text{s}$ , Duty Cycle = 10%

### RF Characterization – Mismatch Ruggedness at 1.3 GHz

Symbol	Parameter	dB Compression	Typical
VSWR	Impedance Mismatch Ruggedness	3	10:1

Test conditions unless otherwise noted:  $T_A = 25\text{ }^\circ\text{C}$ ,  $V_D = 50\text{ V}$ ,  $I_{DQ} = 1000\text{ mA}$

Input drive power is determined at pulsed 3dB compression under matched condition at EVB output connector.

Measured Load-Pull Smith Charts<sup>1,2</sup>

Notes:

1. Test Conditions:  $V_D = 50\text{ V}$ ,  $I_{DQ} = 1000\text{ mA}$ , 300  $\mu\text{s}$  Pulse Width, 10% Duty Cycle
2. See page 18 for load pull reference planes where the performance was measured.

1.1GHz, Load-pull

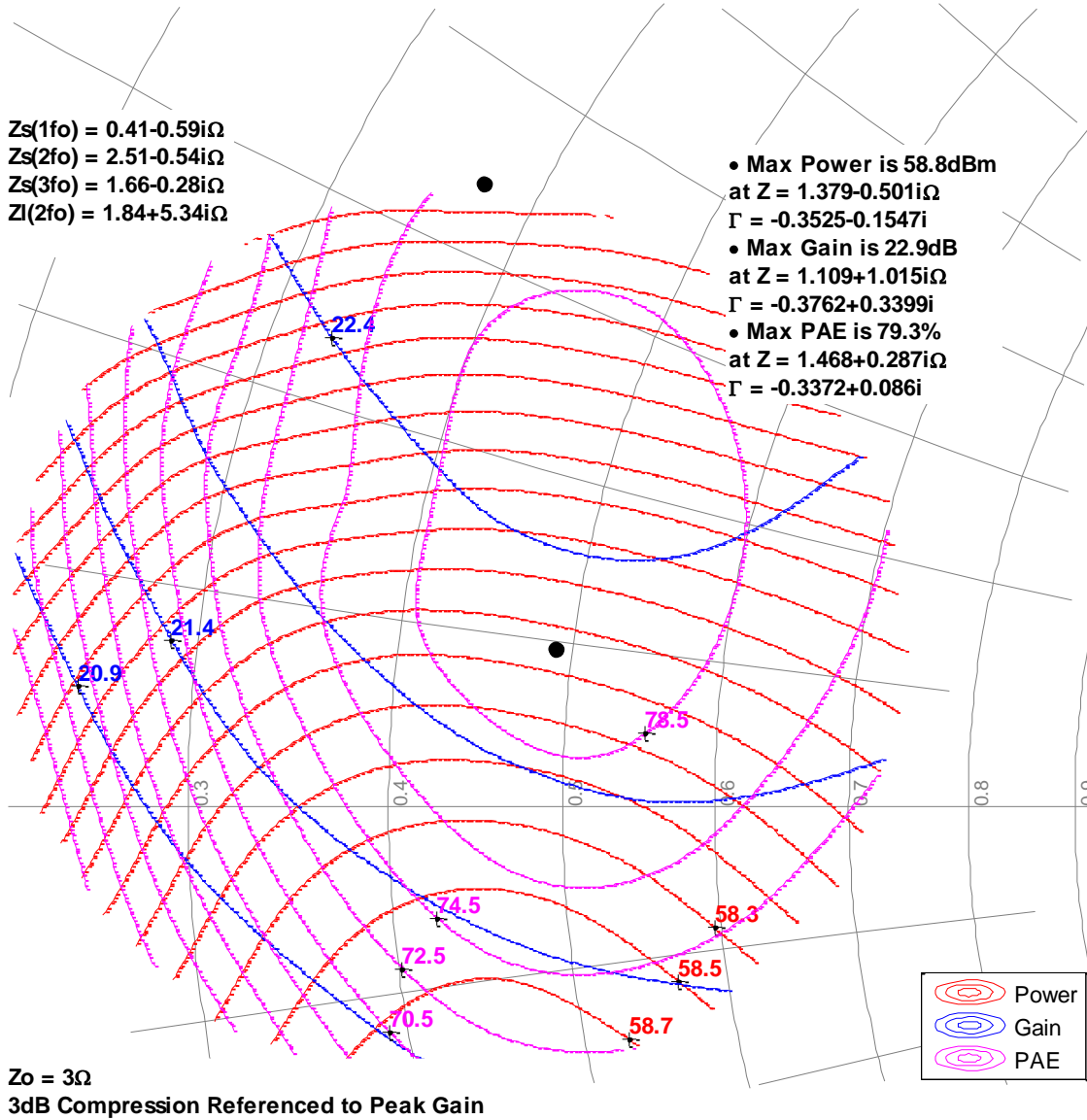

Measured Load-Pull Smith Charts<sup>1, 2</sup>

Notes:

1. Test Conditions:  $V_D = 50\text{ V}$ ,  $I_{DQ} = 1000\text{ mA}$ , 300 uS Pulse Width, 10% Duty Cycle
2. See page 18 for load pull reference planes where the performance was measured.

1.2GHz, Load-pull

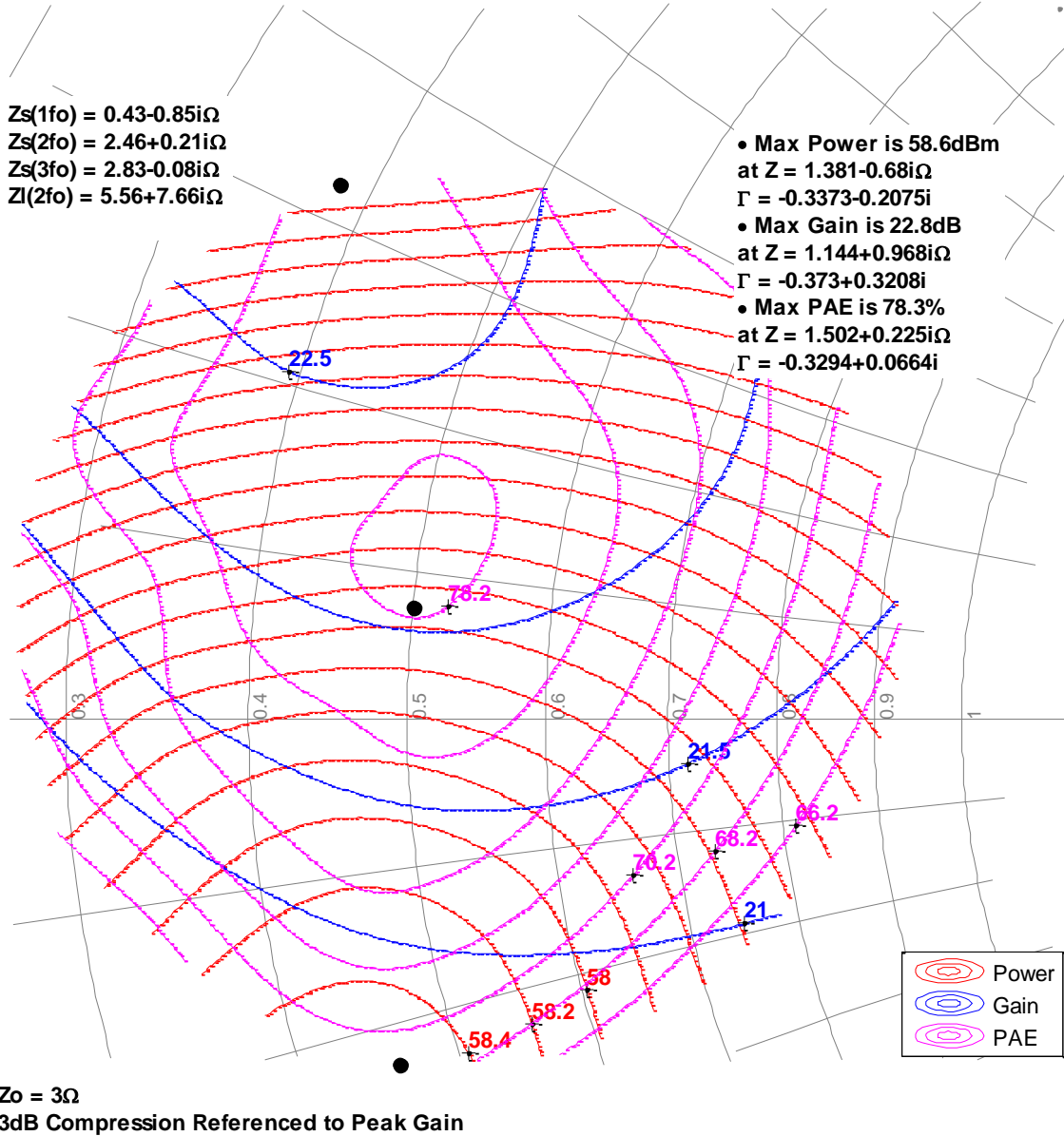

Measured Load-Pull Smith Charts<sup>1, 2</sup>

Notes:

1. Test Conditions:  $V_D = 50\text{ V}$ ,  $I_{DQ} = 1000\text{ mA}$ , 300 uS Pulse Width, 10% Duty Cycle
2. See page 18 for load pull reference planes where the performance was measured.

1.3GHz, Load-pull

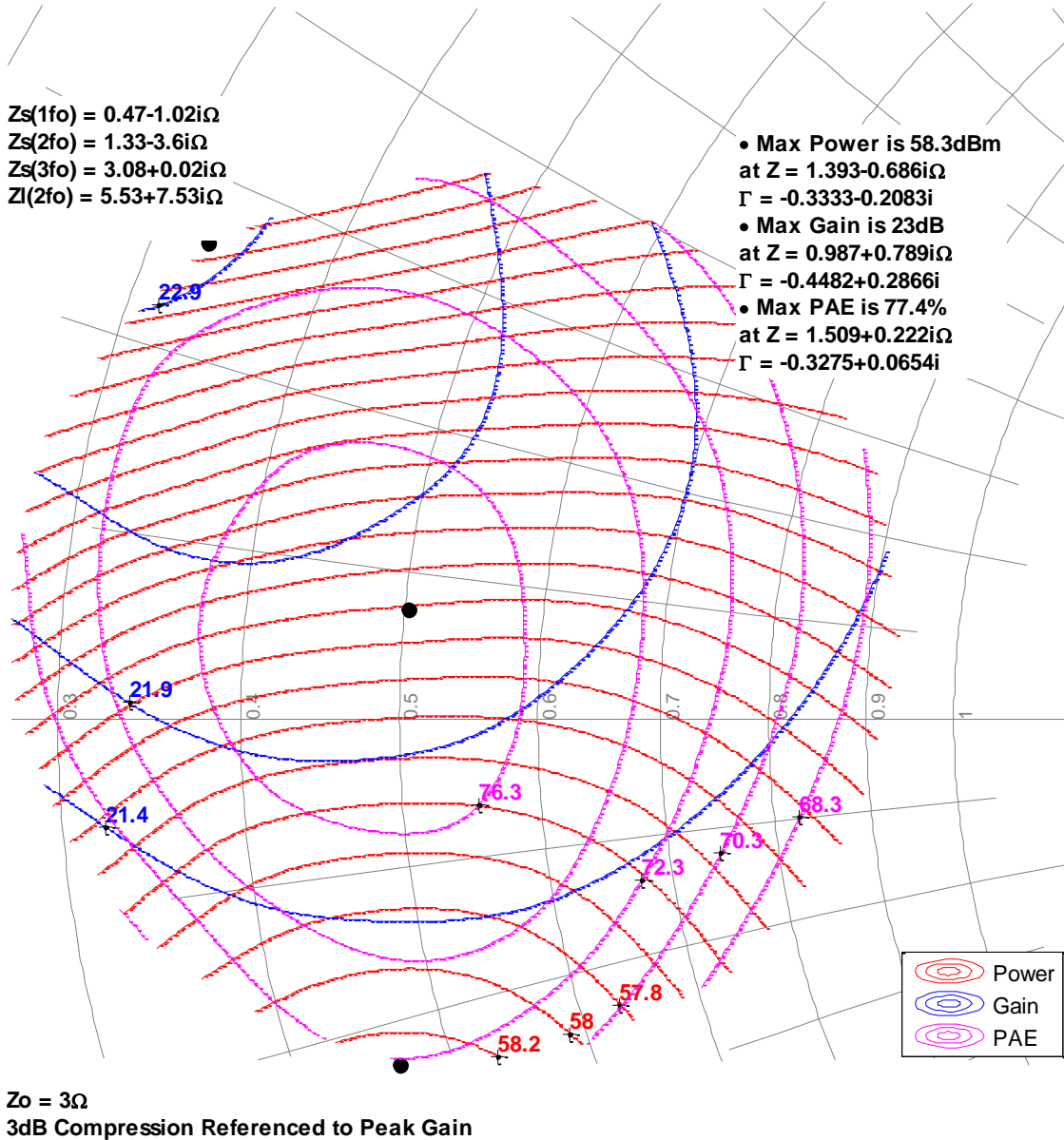

Measured Load-Pull Smith Charts<sup>1, 2</sup>

Notes:

1. Test Conditions:  $V_D = 50\text{ V}$ ,  $I_{DQ} = 1000\text{ mA}$ , 300  $\mu\text{s}$  Pulse Width, 10% Duty Cycle
2. See page 18 for load pull reference planes where the performance was measured.

1.4GHz, Load-pull

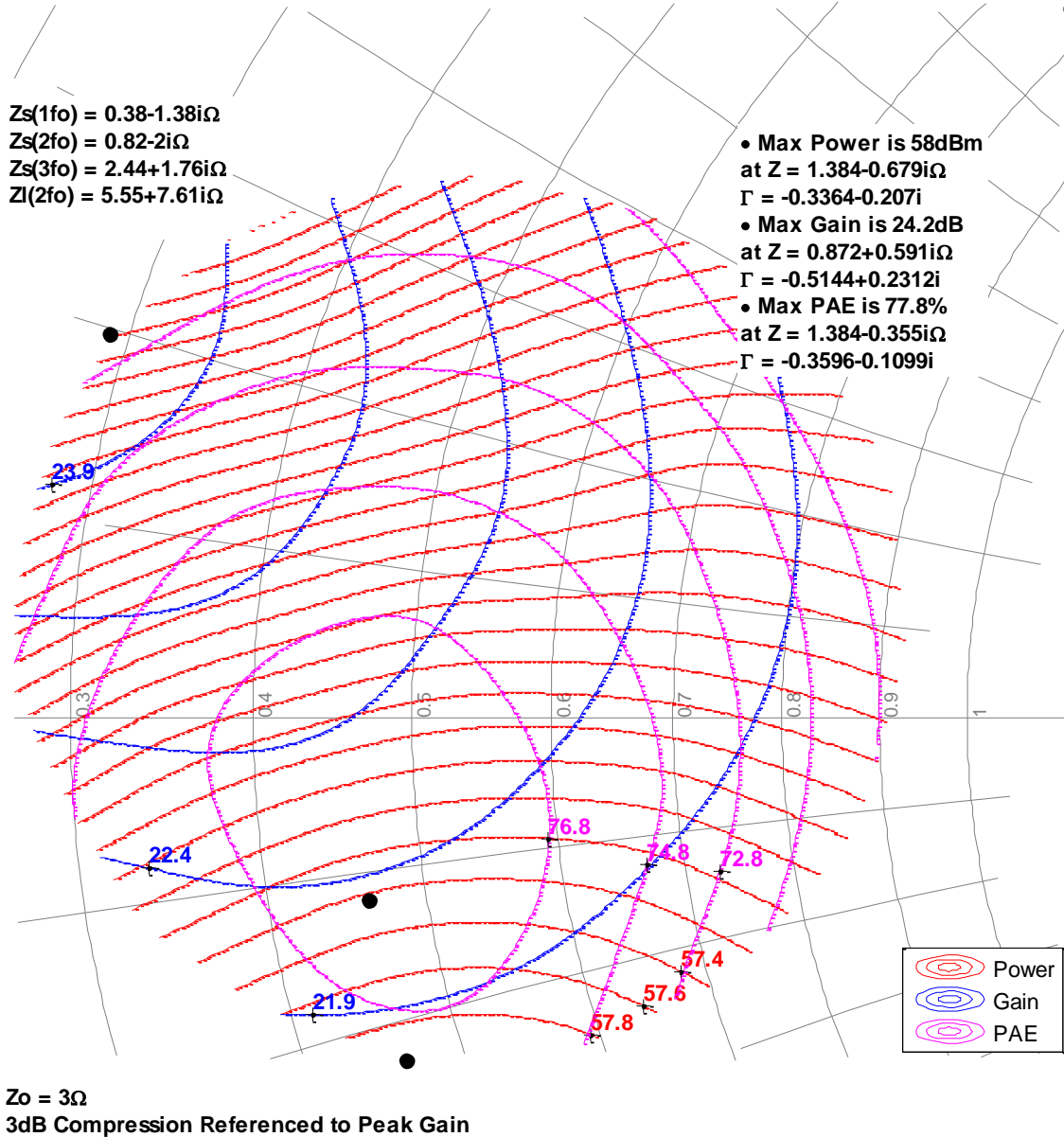

Measured Load-Pull Smith Charts<sup>1, 2</sup>

Notes:

1. Test Conditions:  $V_D = 50\text{ V}$ ,  $I_{DQ} = 1000\text{ mA}$ , 300 uS Pulse Width, 10% Duty Cycle
2. See page 18 for load pull reference planes where the performance was measured.

1.5GHz, Load-pull

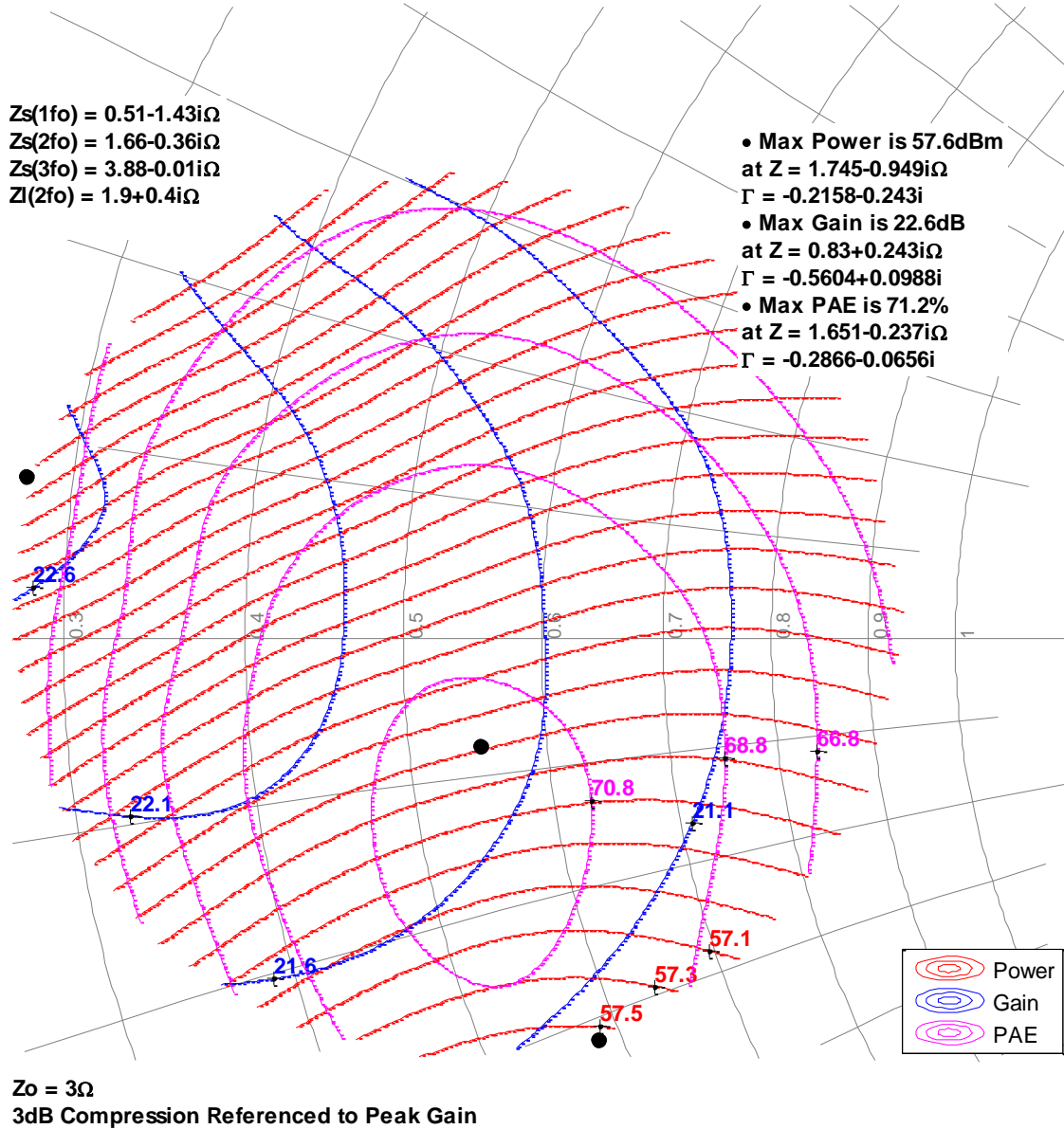



Measured Load-Pull Smith Charts<sup>1, 2</sup>

Notes:

1. Test Conditions:  $V_D = 50\text{ V}$ ,  $I_{DQ} = 1000\text{ mA}$ , 300  $\mu\text{s}$  Pulse Width, 10% Duty Cycle
2. See page 18 for load pull reference planes where the performance was measured.

1.7GHz, Load-pull

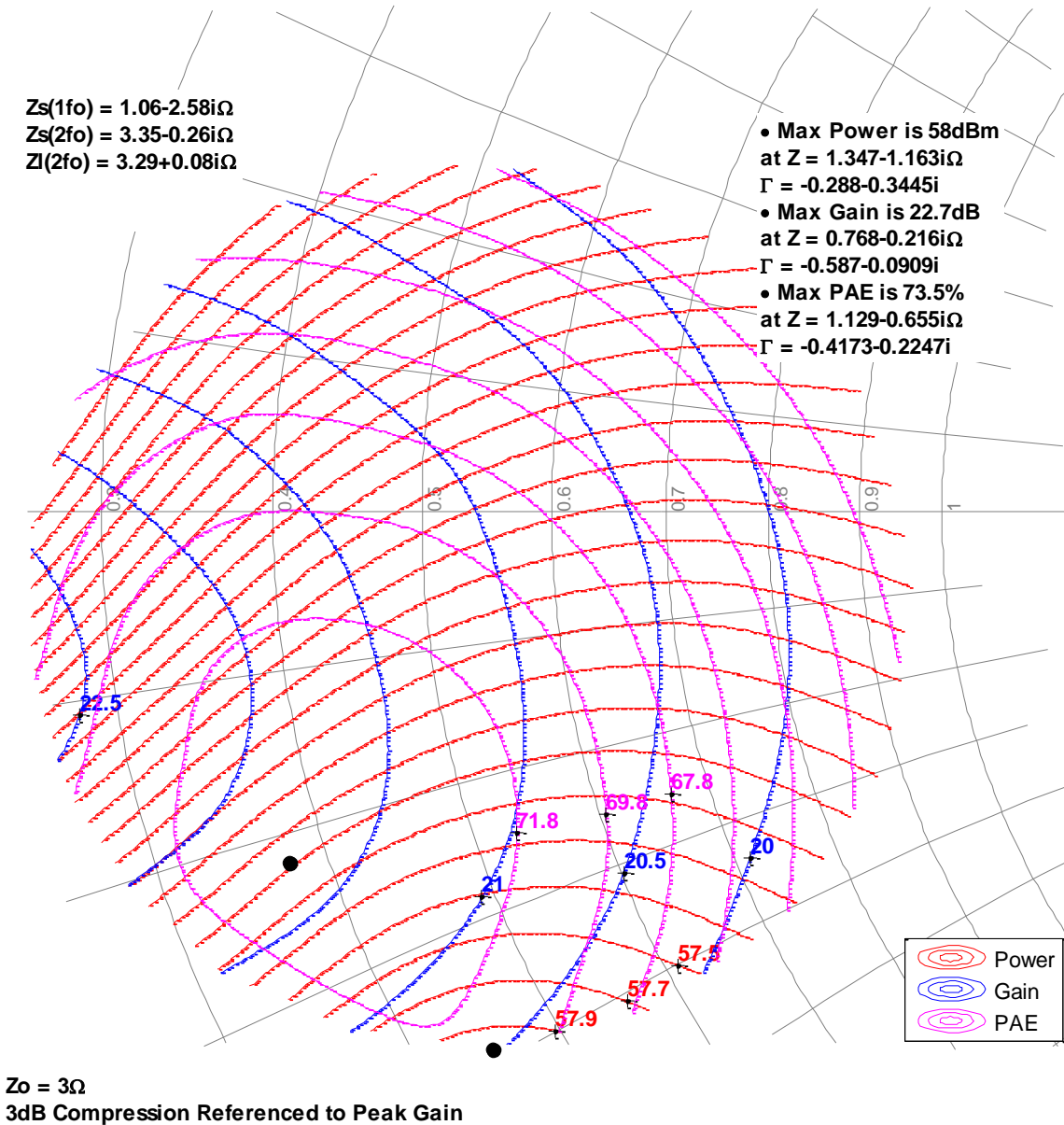

### Typical Measured Performance – Load-Pull Drive-up<sup>1,2</sup>

Notes:

1. Test Conditions:  $V_D = 50\text{ V}$ ,  $I_{DQ} = 1000\text{ mA}$ , 300  $\mu\text{s}$  Pulse Width, 10% Duty Cycle
2. See page 18 for load-pull and source-pull reference planes where the performance was measured.

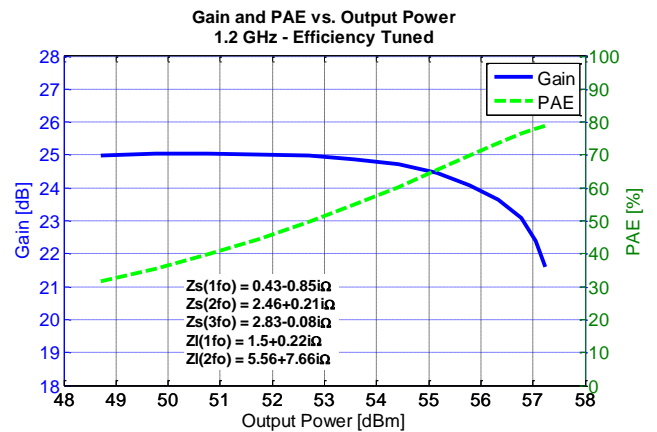
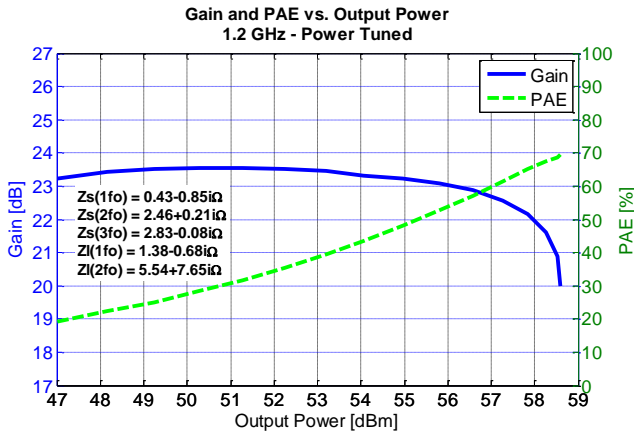
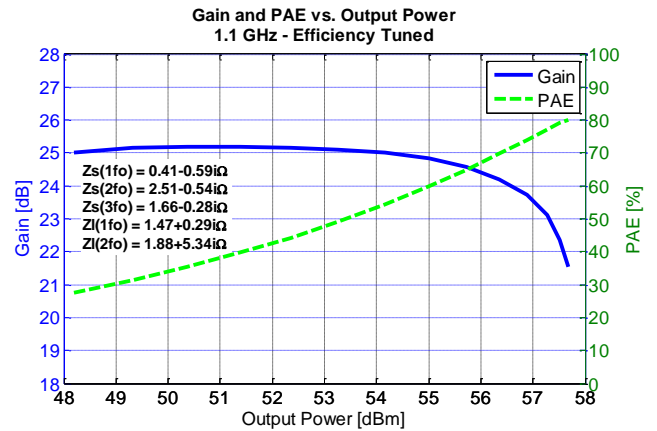
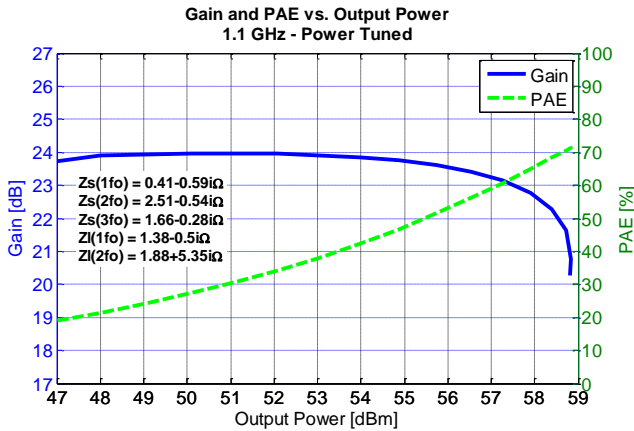

### Typical Measured Performance – Load-Pull Drive-up<sup>1, 2</sup>

Notes:

1. C Test Conditions:  $V_D = 50\text{ V}$ ,  $I_{DQ} = 1000\text{ mA}$ , 300  $\mu\text{s}$  Pulse Width, 10% Duty Cycle
2. See page 18 for load-pull and source-pull reference planes where the performance was measured.

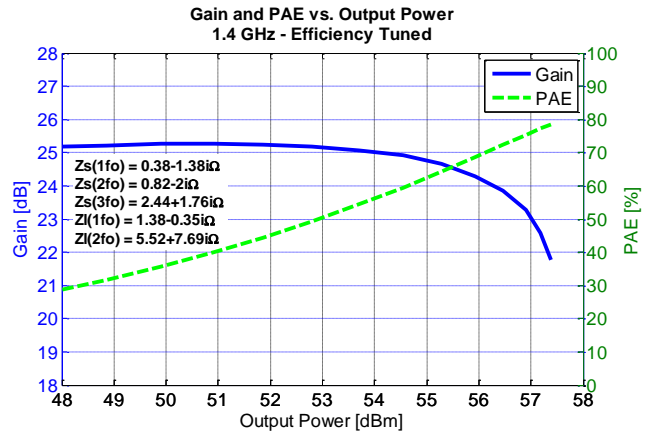
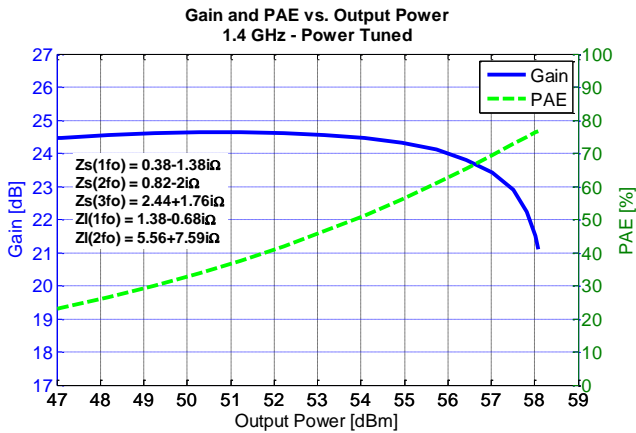
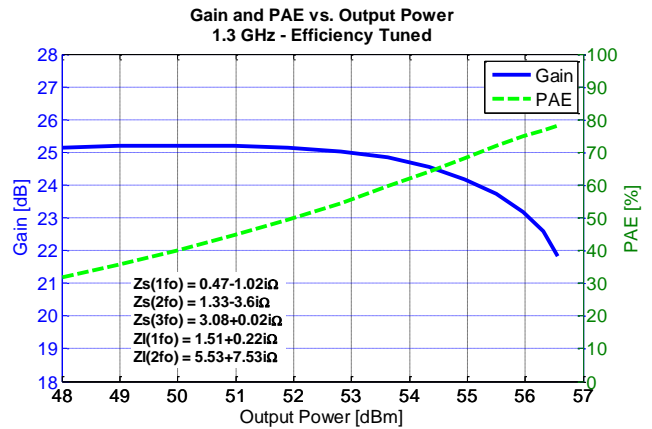
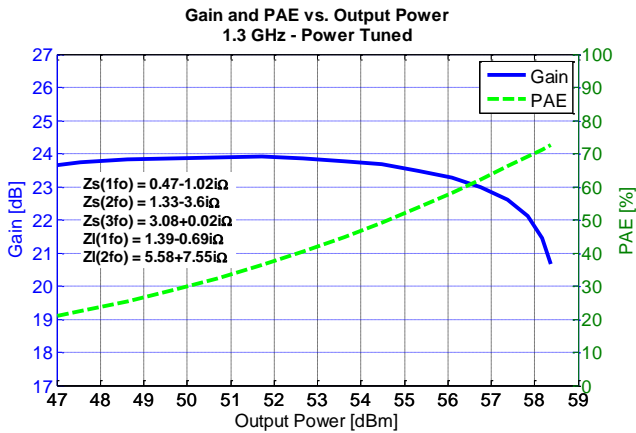

### Typical Measured Performance – Load-Pull Drive-up<sup>1, 2</sup>

Notes:

1. Test Conditions:  $V_D = 50\text{ V}$ ,  $I_{DQ} = 1000\text{ mA}$ , 300  $\mu\text{s}$  Pulse Width, 10% Duty Cycle
2. See page 18 for load-pull and source-pull reference planes where the performance was measured.

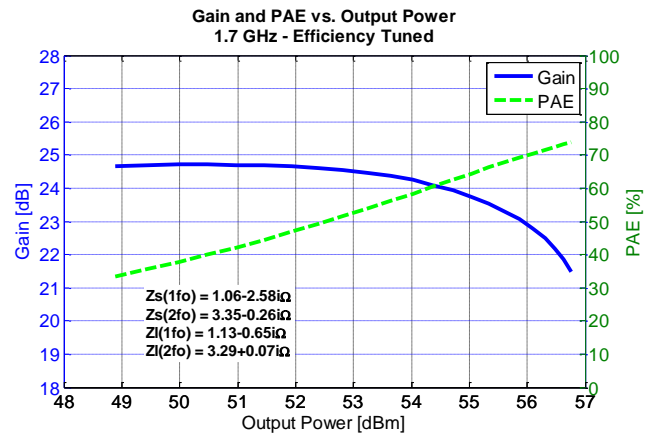
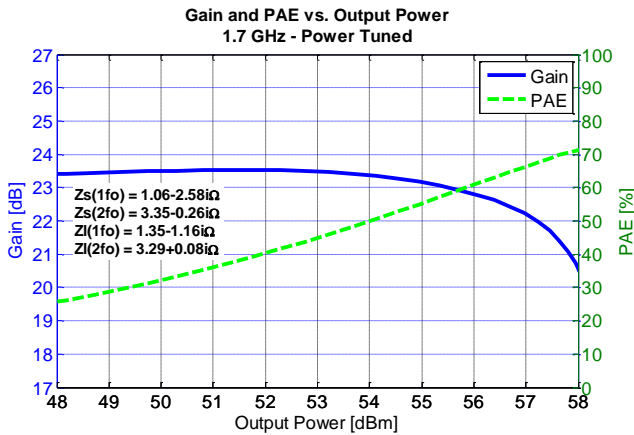
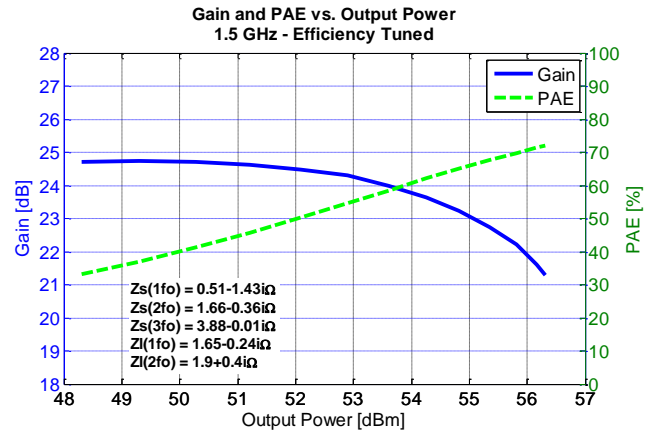
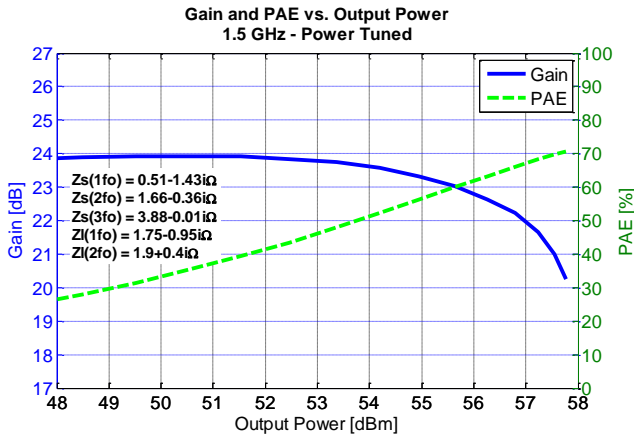

### Power Driveup Performance Over Temperatures Of 1.2 – 1.4 GHz EVB<sup>1,2</sup>

Notes:

1. Test Conditions:  $V_D = 50\text{ V}$ ,  $I_{DQ} = 1000\text{ mA}$ , 300  $\mu\text{s}$  Pulse Width, 10% Duty Cycle

**P3dB Over Temperatures**

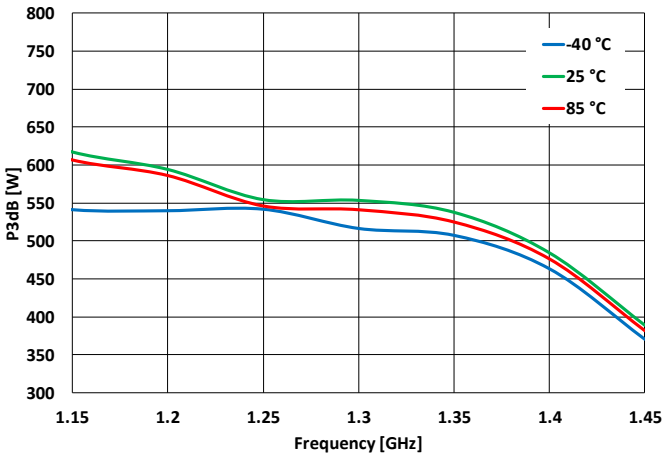

**DEFF3dB Over Temperatures**

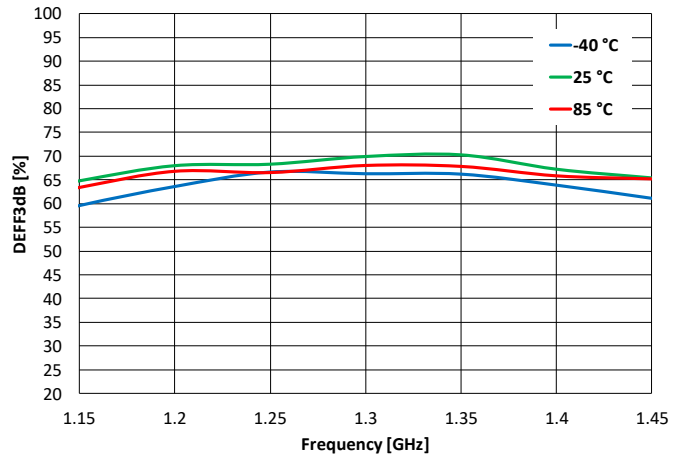

**G3dB Over Temperatures**

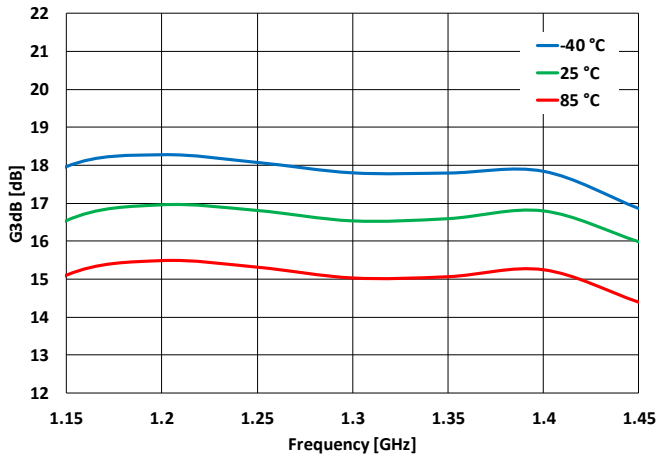

**Pdiss3dB Over Temperatures**

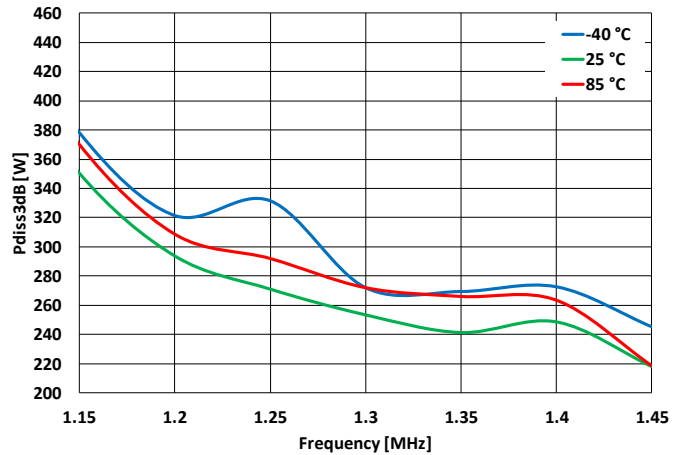

### Power Driveup Performance At 25°C Of 1.2 – 1.4 GHz EVB<sup>1, 2</sup>

Notes:

1. Test Conditions:  $V_D = 50\text{ V}$ ,  $I_{DQ} = 1000\text{ mA}$ , 300  $\mu\text{s}$  Pulse Width, 10% Duty Cycle

**P3dB At 25 °C**

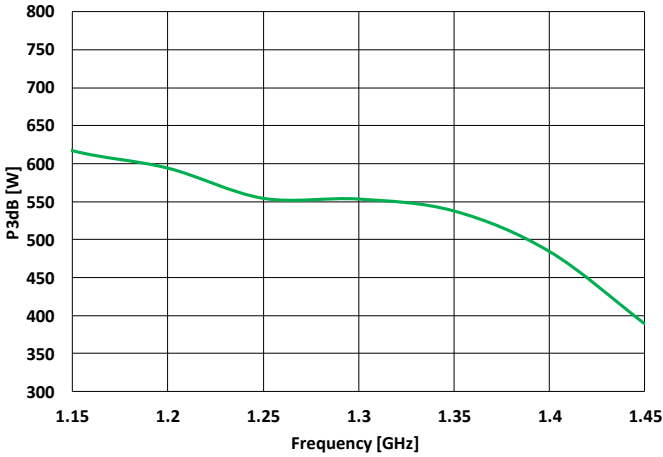

**DEFF3dB At 25 °C**

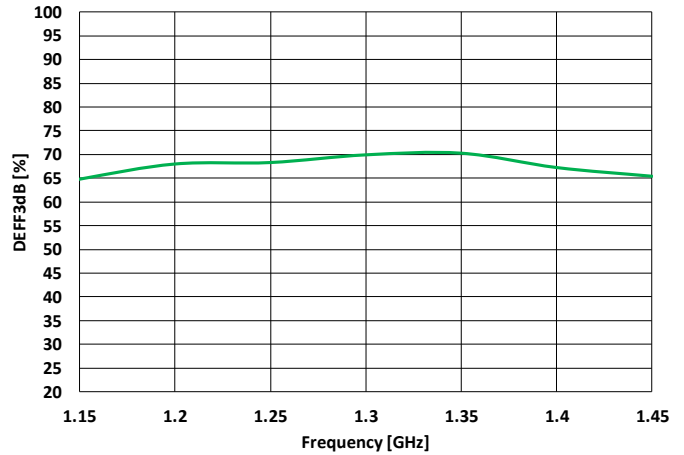

**G3dB At 25 °C**

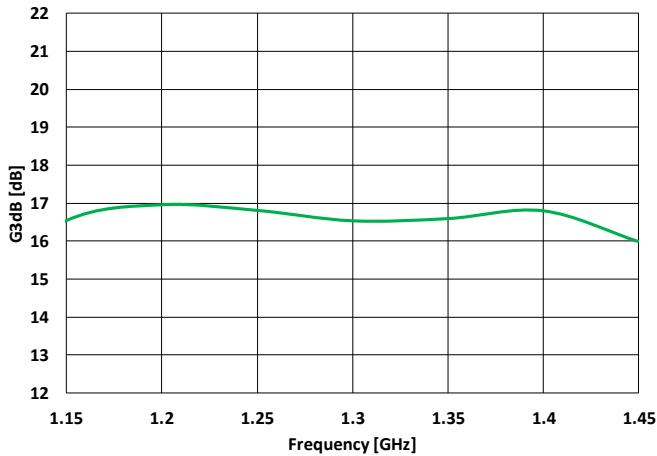

**Pdiss3dB At 25 °C**

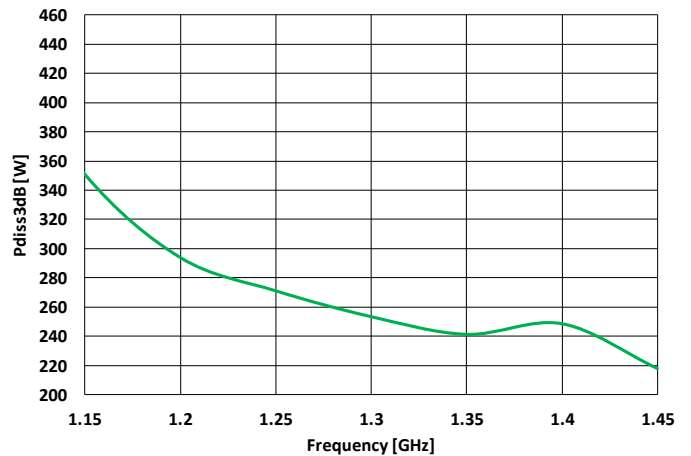

### Thermal and Reliability Information – Pulsed<sup>1, 2, 3</sup>

**Peak IR Surface Temperature vs. PW vs. Pulsed Dissipation Power**  
**Base Temperature at 85 °C**

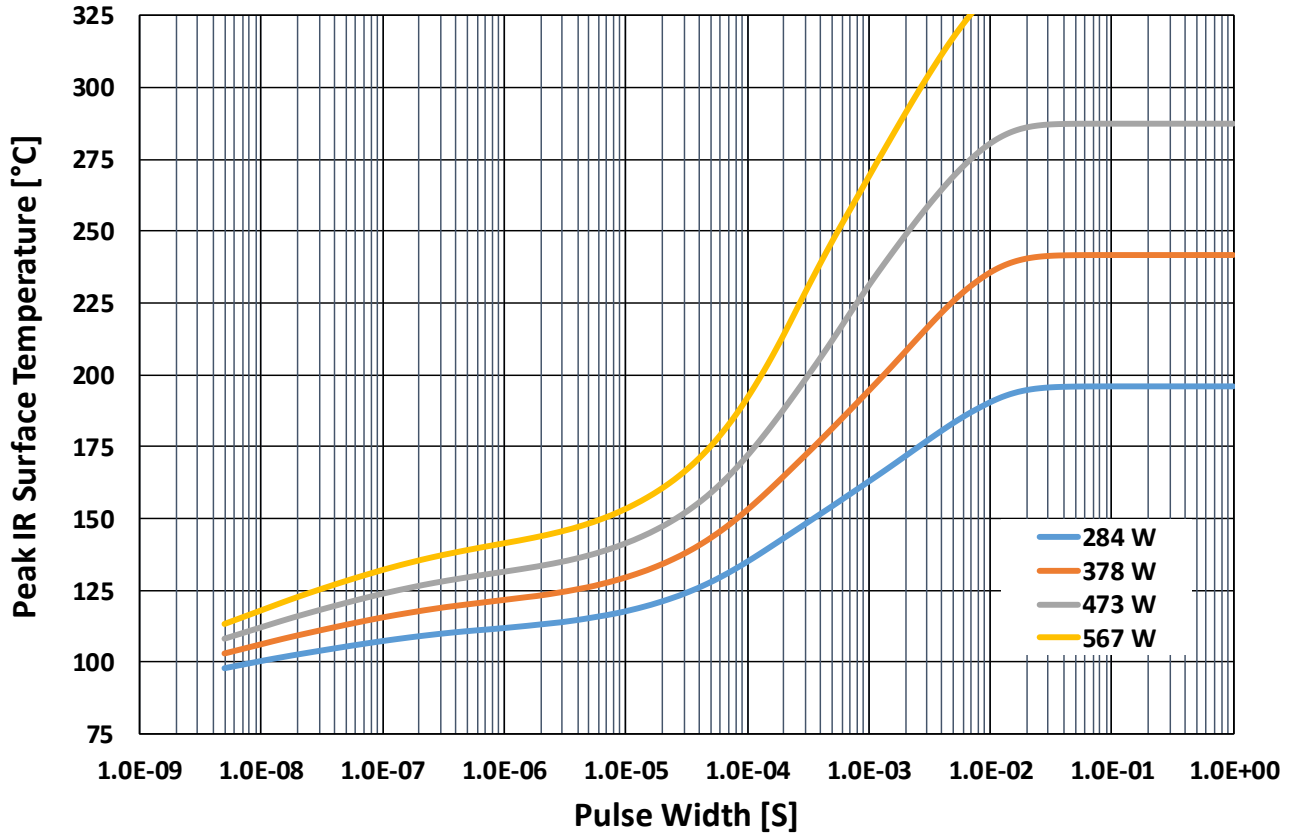

Parameter <sup>1</sup>	Conditions	Values	Units
Thermal Resistance, IR ( $\theta_{JC}$ )	85 °C Case	0.22	°C/W
Peak Channel Temperature, IR ( $T_{CH}$ )	284 W P <sub>diss</sub> , 300 uS PW, 10% DC	148	°C
Thermal Resistance, IR ( $\theta_{JC}$ )	85 °C Case	0.23	°C/W
Peak Channel Temperature, IR ( $T_{CH}$ )	378 W P <sub>diss</sub> , 300 uS PW, 10% DC	172	°C
Thermal Resistance, IR ( $\theta_{JC}$ )	85 °C Case	0.24	°C/W
Peak Channel Temperature, IR ( $T_{CH}$ )	473 W P <sub>diss</sub> , 300 uS PW, 10% DC	198	°C
Thermal Resistance, IR ( $\theta_{JC}$ )	85 °C Case	0.25	°C/W
Peak Channel Temperature, IR ( $T_{CH}$ )	567 W P <sub>diss</sub> , 300 uS PW, 10% DC	228	°C

Notes:

1. Refer to the following document [GaN Device Channel Temperature, Thermal Resistance, and Reliability Estimates](#)

**Thermal and Reliability Information – CW<sup>1, 2, 3</sup>**

### Peak IR Surface Temperature vs. CW Power Base Temperature at 85 °C

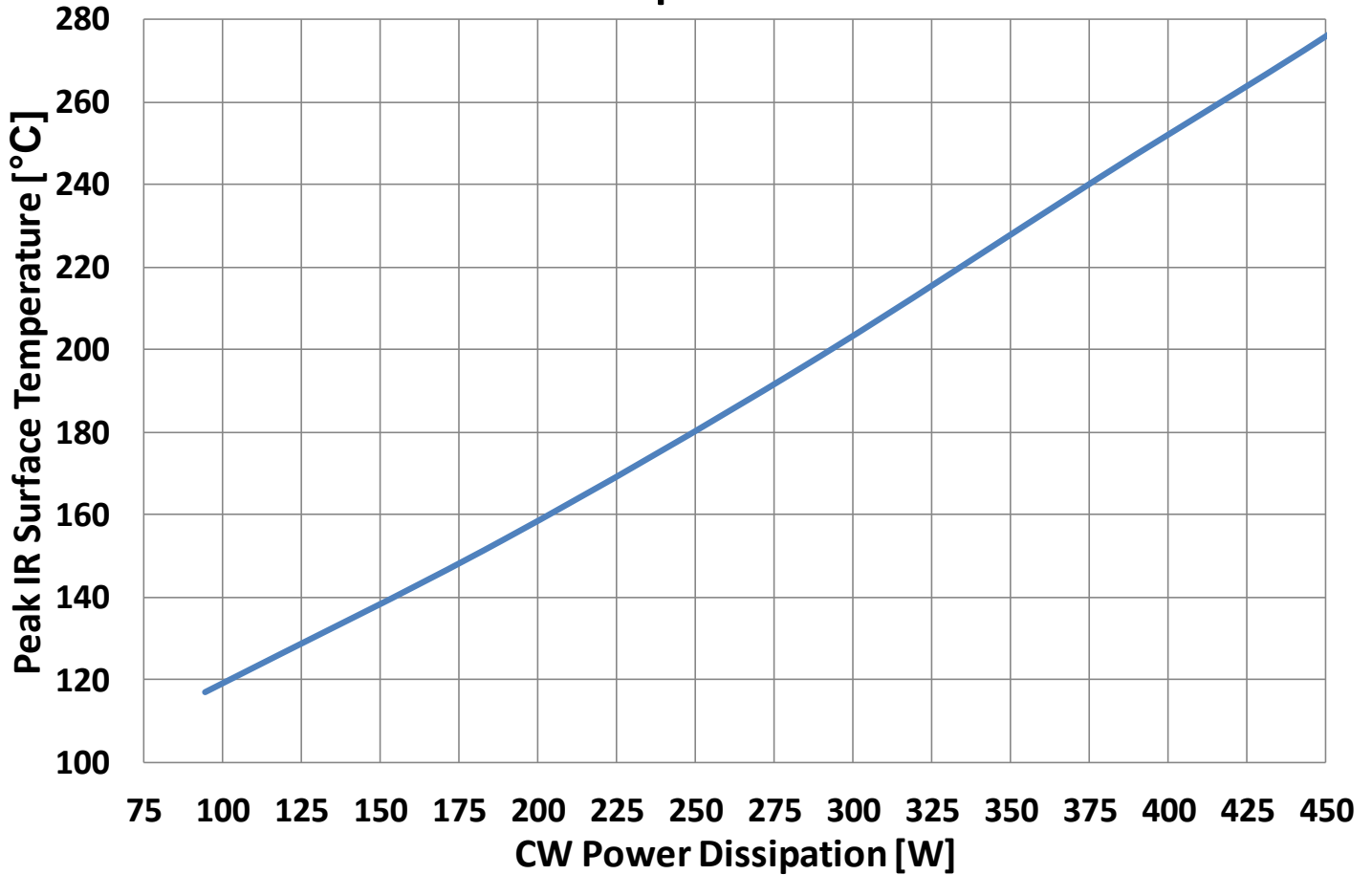

Parameter <sup>1</sup>	Conditions	Values	Units
Thermal Resistance, IR ( $\theta_{JC}$ )	85 °C Case	0.34	°C/W
Peak Channel Temperature, IR ( $T_{CH}$ )	94.5 W Pdiss, CW	117	°C
Thermal Resistance, IR ( $\theta_{JC}$ )	85 °C Case	0.37	°C/W
Peak Channel Temperature, IR ( $T_{CH}$ )	189 W Pdiss, CW	154	°C
Thermal Resistance, IR ( $\theta_{JC}$ )	85 °C Case	0.39	°C/W
Peak Channel Temperature, IR ( $T_{CH}$ )	284 W Pdiss, CW	196	°C
Thermal Resistance, IR ( $\theta_{JC}$ )	85 °C Case	0.42	°C/W
Peak Channel Temperature, IR ( $T_{CH}$ )	378 W Pdiss, CW	242	°C

Notes:

1. Refer to the following document [GaN Device Channel Temperature, Thermal Resistance, and Reliability Estimates](#)



Maximum Gate Current

Maximum Gate Current Vs. IR Surface Temperature

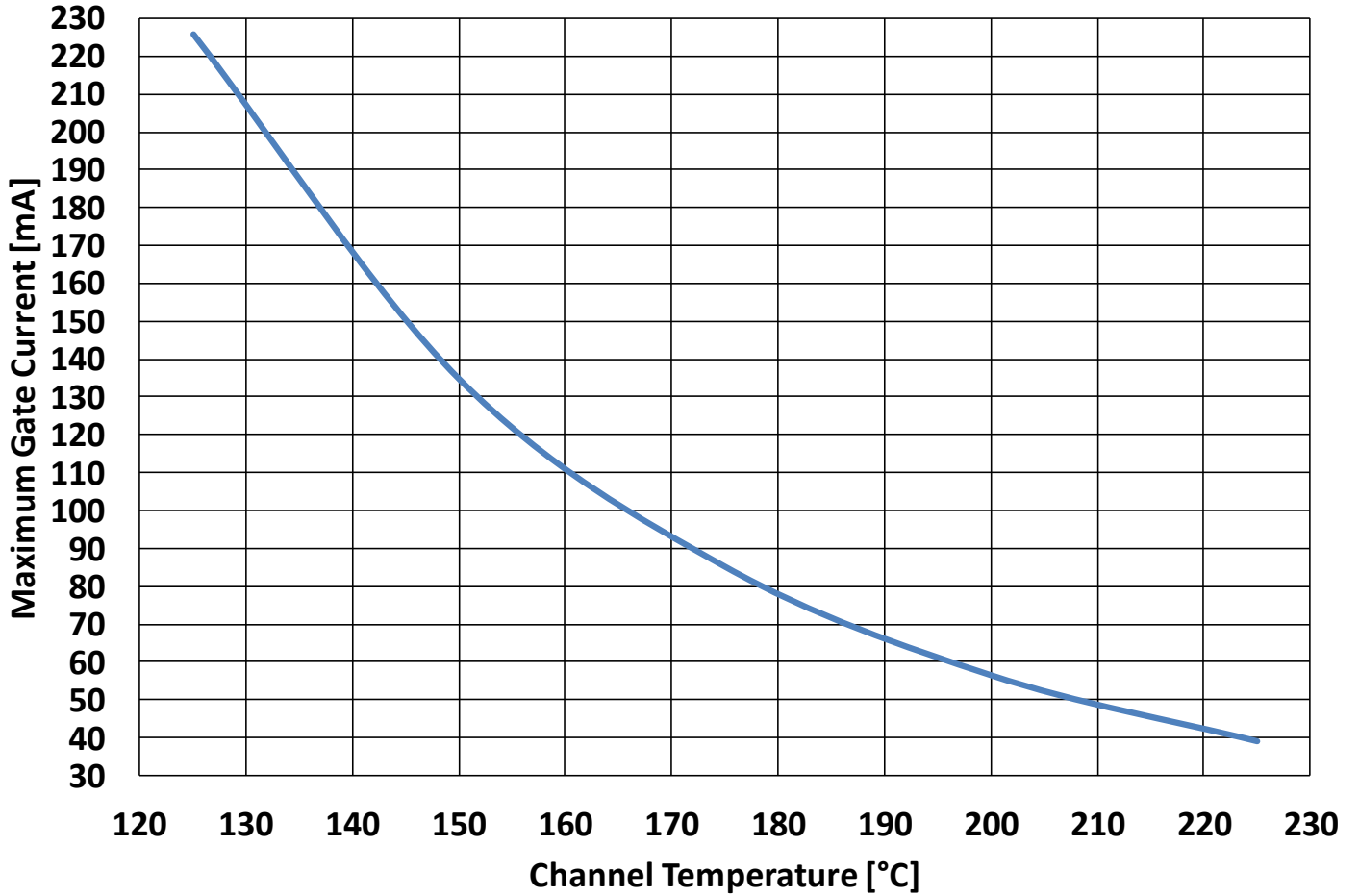

### Pin Configuration and Description<sup>1</sup>

Note 1: The QPD1016 will be marked with the “QPD1016” designator and a lot code marked below the part designator. The “YY” represents the last two digits of the calendar year the part was manufactured, the “WW” is the work week of the assembly lot start, the MXXX” is the production lot number, and the “ZZZ” is an auto-generated serial number.

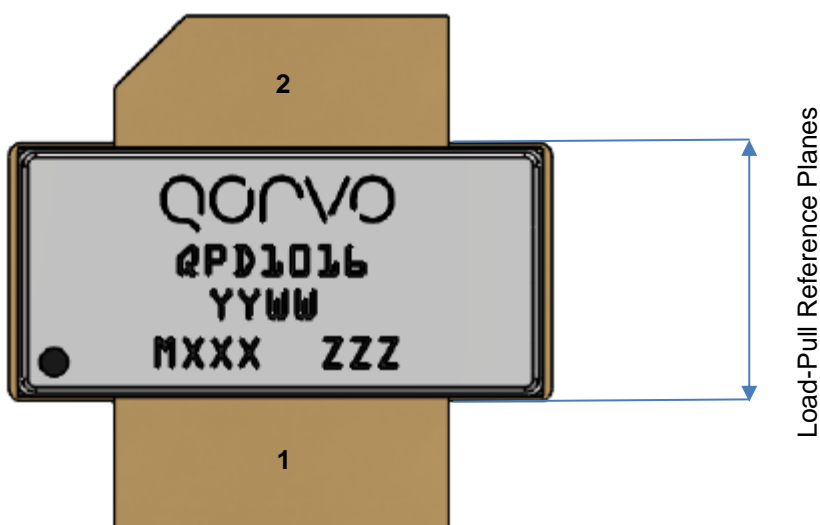

Pin	Symbol	Description
1	RF IN / $V_G$	Gate
2	RF OUT / $V_D$	Drain
3	Source	Source / Ground / Backside of part

### Mechanical Drawing<sup>1</sup>

<sup>1</sup>Notes:

1. Dimension tolerances are  $\pm 0.005$  mil for lengths and  $0.5^\circ$  for angles.
2. Material:
  - Package base: Ceramic/Metal
  - Package lid: Ceramic
  - Leads: Alloy 42 Kovar
3. Package exposed metallization is gold plated.
4. Part is epoxy sealed.
5. Part meets industry N780 footprint.
6. Body dimensions do not include lid shift or epoxy run out which can be up to 20 mils per side.

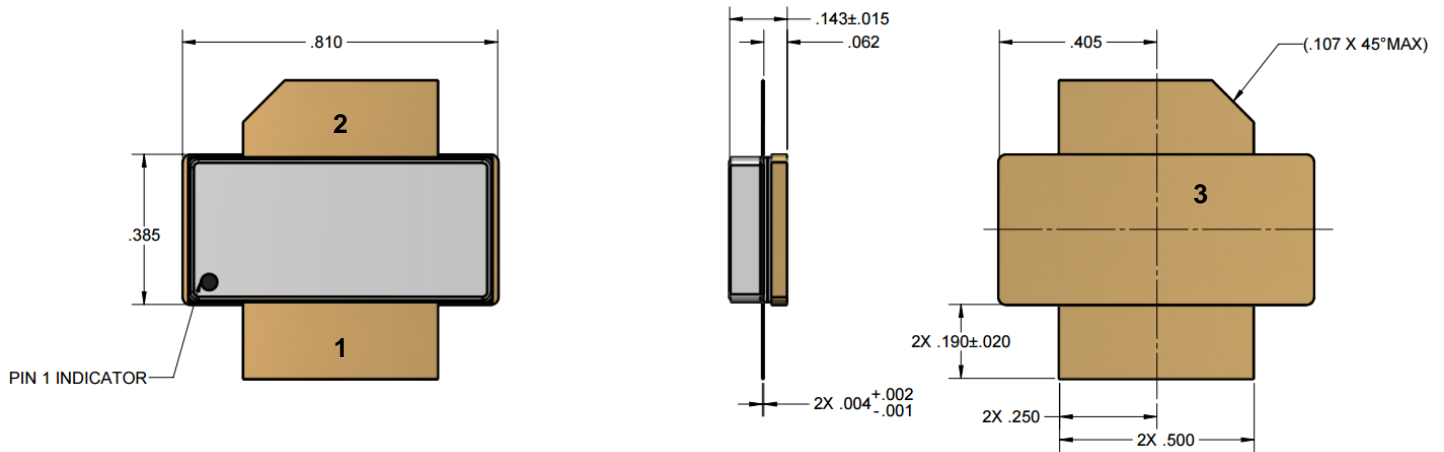

### 1.2 – 1.4 GHz Application Circuit - Schematic

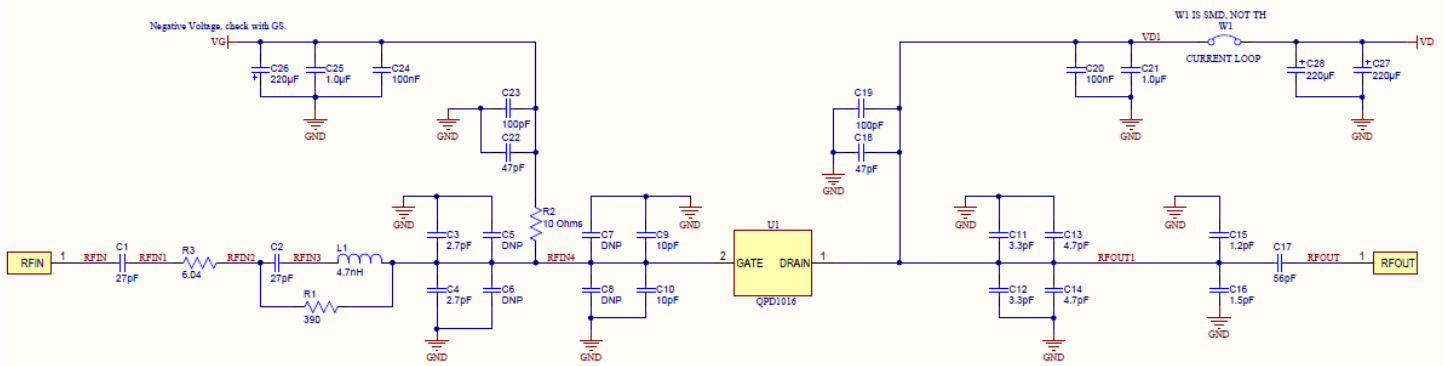

Bias-up Procedure	Bias-down Procedure
1. Set $V_G$ to -4 V.	1. Turn off RF signal.
2. Set $I_D$ current limit to 1100 mA.	2. Turn off $V_D$
3. Apply 50 V $V_D$ .	3. Wait 2 seconds to allow drain capacitor to discharge
4. Slowly adjust $V_G$ until $I_D$ is set to 1000 mA.	4. Turn off $V_G$
5. Set $I_D$ current limit to 7 A (Pulsed operation)	
6. Apply RF.	

1.2 – 1.4 GHz Application Circuit - Layout

Board material is RO4350B 0.020" thickness with 2oz copper cladding. Overall EVB size is 3.98" x 3.98".

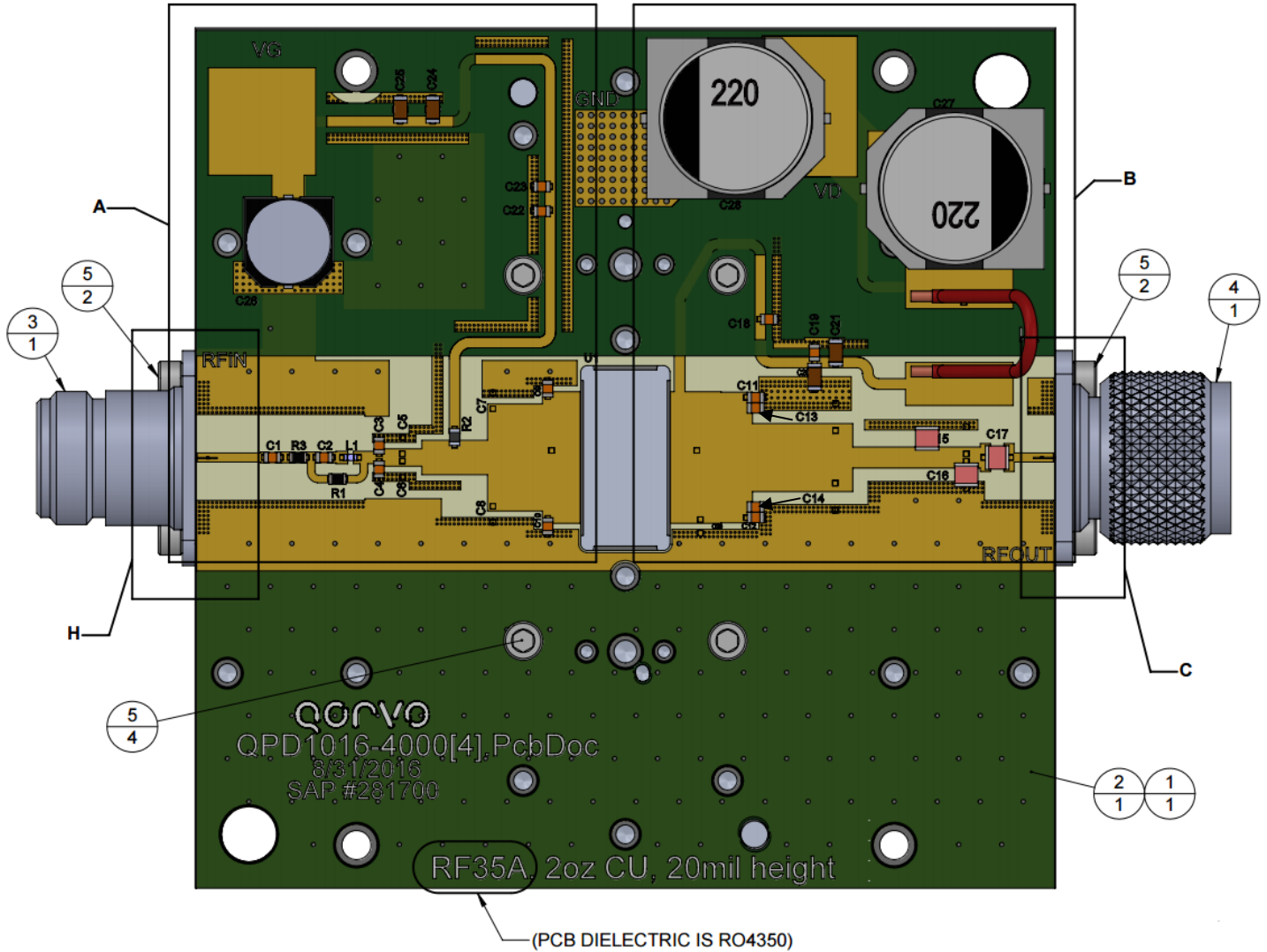

## 1.2 – 1.4 GHz Application Circuit - Bill Of material

Description	Ref. Des.	Manufacturer	Part Number
Capacitor 27pF, 250v, 1% NPO 0805 600F	C1, C2	American Technical Ceramics	600F270FT250XT
Capacitor 2.7 pF, 250V, 0805, 600F	C3, C4	American Technical Ceramics	600F2R7BT250XT
DO NOT PLACE	C5, C6, C7,C8		
Capacitor 10 pF, 600F-Series	C9, C10	American Technical Ceramics	600F100CT
Capacitor 3.3 pF, 600F-Series	C11, C12	American Technical Ceramics	600F3R3CT
Capacitor 4.7 pF, 600F-Series	C13, C14	American Technical Ceramics	600F4R7CT
Capacitor 1.2 pF, 2%, 500v, COG 800B	C15	American Technical Ceramics	800B1R2CT500X
Capacitor 1.5 pF, 2%, 500v, COG 800B	C16	American Technical Ceramics	800B1R5CT500X
Capacitor 56 pF, 2%, 500v, COG 800B	C17	American Technical Ceramics	800B560JT500X
Capacitor 47 pF, 5%, 250V, 0805, 600F	C18, C22	American Technical Ceramics	600F470JT250XT
Capacitor 100 pF, 600F-Series	C19, C23	American Technical Ceramics	600F101JT
Capacitor, 100nF, 10%, 100V X7R1206	C20, C24	N/A	N/A
Capacitor, 1uF, 20%, 100V X7R1206	C21, C25	Murata	GRM32ER72A105MA01L
Capacitor 220 uF, 20%, 100V, SMD Electrolytic	C27, C28	Nichicon	UUJ2A221MNPQ1MS
Capacitor 220 uF, 20%, 50V, SMD Electrolytic	C26	Panasonic	EMVY500ADA221MJA0G
Resistor, 390 Ohm, 1%, 1/10W, 0805	R1	Rohm Electronics	MCR03EZPF6200
Resistor, 10 Ohm, 1%, 1/10W, 0805	R2	Panasonic	ERJ-6ENF10R0V
Resistor, 6.04ohm, 1%, 1/10W, 0805	R3	Panasonic	

Recommended Solder Temperature Profile

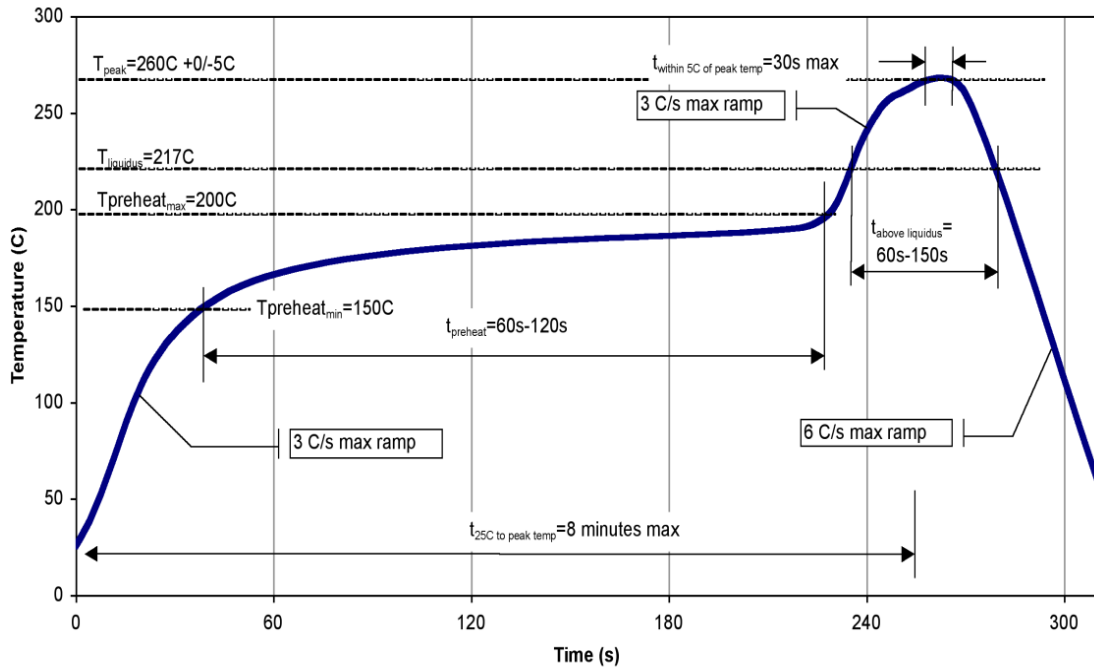

### Handling Precautions

Parameter	Rating	Standard
ESD – Human Body Model (HBM)	Class 2 2150 V	ANSI/ESD/JEDEC JS-001
ESD – Charged Device Model (CDM)	Class C3 1000V	ANSI/ESD/JEDEC JS-002
MSL – Moisture Sensitivity Level	MSL3	IPC/JEDEC J-STD-020



Caution!  
ESD-Sensitive Device

### Solderability

Compatible with both lead-free (260°C max. reflow temp.) and tin/lead (245°C max. reflow temp.) soldering processes. Solder profiles available upon request.

Package lead plating is NiAu. Au thickness is 60 microinches.

### RoHS Compliance

This part is compliant with 2011/65/EU RoHS directive (Restrictions on the Use of Certain Hazardous Substances in Electrical and Electronic Equipment) as amended by Directive 2015/863/EU.

This product also has the following attributes:

- Halogen Free (Chlorine, Bromine)
- Antimony Free
- TBBP-A (C<sub>15</sub>H<sub>12</sub>Br<sub>4</sub>O<sub>2</sub>) Free
- PFOS Free
- SVHC Free

### Contact Information

For the latest specifications, additional product information, worldwide sales and distribution locations:

**Web:** [www.qorvo.com](http://www.qorvo.com)      **Tel:** +1.844.890.8163  
**Email:** [customer.support@qorvo.com](mailto:customer.support@qorvo.com)

For technical questions and application information:      **Email:** [info-products@qorvo.com](mailto:info-products@qorvo.com)

### Important Notice

The information contained herein is believed to be reliable; however, Qorvo makes no warranties regarding the information contained herein and assumes no responsibility or liability whatsoever for the use of the information contained herein. All information contained herein is subject to change without notice. Customers should obtain and verify the latest relevant information before placing orders for Qorvo products. The information contained herein or any use of such information does not grant, explicitly or implicitly, to any party any patent rights, licenses, or any other intellectual property rights, whether with regard to such information itself or anything described by such information. **THIS INFORMATION DOES NOT CONSTITUTE A WARRANTY WITH RESPECT TO THE PRODUCTS DESCRIBED HEREIN, AND QORVO HEREBY DISCLAIMS ANY AND ALL WARRANTIES WITH RESPECT TO SUCH PRODUCTS WHETHER EXPRESS OR IMPLIED BY LAW, COURSE OF DEALING, COURSE OF PERFORMANCE, USAGE OF TRADE OR OTHERWISE, INCLUDING THE IMPLIED WARRANTIES OF MERCHANTABILITY AND FITNESS FOR A PARTICULAR PURPOSE.**

Without limiting the generality of the foregoing, Qorvo products are not warranted or authorized for use as critical components in medical, life-saving, or life-sustaining applications, or other applications where a failure would reasonably be expected to cause severe personal injury or death.

Copyright 2016 © Qorvo, Inc. | Qorvo is a registered trademark of Qorvo, Inc.



## X-ON Electronics

Largest Supplier of Electrical and Electronic Components

*Click to view similar products for [RF Development Tools](#) category:*

*Click to view products by [Qorvo](#) manufacturer:*

Other Similar products are found below :

[MAAM-011117](#) [MAAP-015036-DIEEV2](#) [EV1HMC1113LP5](#) [EV1HMC6146BLC5A](#) [EV1HMC637ALP5](#) [EVAL-ADG919EBZ](#) [ADL5363-EVALZ](#) [LMV228SDEVAL](#) [SKYA21001-EVB](#) [SMP1331-085-EVB](#) [EV1HMC618ALP3](#) [EVAL01-HMC1041LC4](#) [MAAL-011111-000SMB](#) [MAAM-009633-001SMB](#) [MASW-000936-001SMB](#) [107712-HMC369LP3](#) [107780-HMC322ALP4](#) [SP000416870](#) [EV1HMC470ALP3](#) [EV1HMC520ALC4](#) [EV1HMC244AG16](#) [MAX2614EVKIT#](#) [124694-HMC742ALP5](#) [SC20ASATEA-8GB-STD](#) [MAX2837EVKIT+](#) [MAX2612EVKIT#](#) [MAX2692EVKIT#](#) [EV1HMC629ALP4E](#) [SKY12343-364LF-EVB](#) [108703-HMC452QS16G](#) [EV1HMC863ALC4](#) [EV1HMC427ALP3E](#) [119197-HMC658LP2](#) [EV1HMC647ALP6](#) [ADL5725-EVALZ](#) [MAX2371EVKIT#](#) [106815-HMC441LM1](#) [EV1HMC1018ALP4](#) [UXN14M9PE](#) [MAX2016EVKIT](#) [EV1HMC939ALP4](#) [MAX2410EVKIT](#) [MAX2204EVKIT+](#) [EV1HMC8073LP3D](#) [SIMSA868-DKL](#) [SIMSA868C-DKL](#) [SKY65806-636EK1](#) [SKY68020-11EK1](#) [SKY67159-396EK1](#) [SKY66181-11-EK1](#)