

### Product Overview

The Qorvo QPD1020 is a 30 W ( $P_{3dB}$ ), 50  $\Omega$ -input matched discrete GaN on SiC HEMT which operates from 2.7 to 3.5 GHz and 50 V supply. The integrated input matching network enables wideband gain and power performance, while the output can be matched on board to optimize power and efficiency for any region within the band.

Lead-free and ROHS compliant.

Evaluation boards are available upon request.

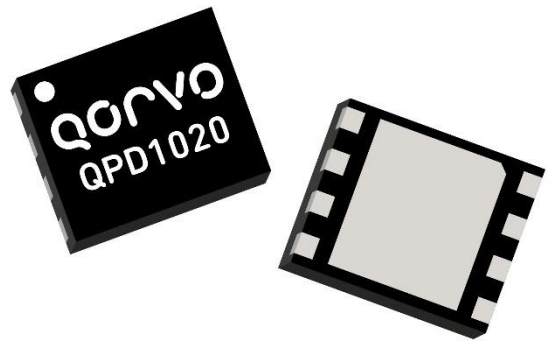

6 x 5 x 1.09 mm DFN

### Functional Block Diagram

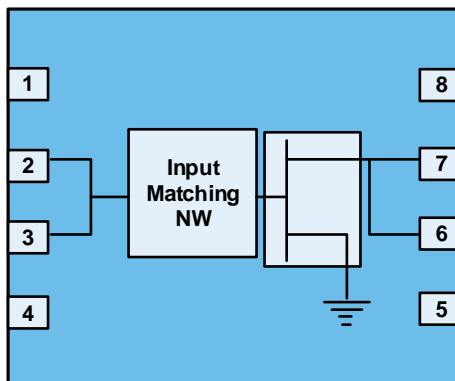

### Key Features

- Frequency: 2.7 to 3.5 GHz
  - Output Power ( $P_{3dB}$ )<sup>1</sup>: 31 W
  - Linear Gain<sup>1</sup>: 18.4 dB
  - Typical  $DEFF_{3dB}$ <sup>1</sup>: 65 %
  - Operating Voltage: 50 V
  - CW and Pulse capable
- Note 1: @ 3.1 GHz Load Pull

### Applications

- Military radar
- Civilian radar
- Test instrumentation

### Ordering info

Part No.	Description
QPD1020S2	Sample of 2 QPD1020
QPD1020SQ	Sample of 25 QPD1020
QPD1020SR	Sample of 100 QPD1020
QPD1020EVB01	2.7 – 3.1 GHz EVB

### Absolute Maximum Ratings<sup>1</sup>

Parameter	Rating	Units
Breakdown Voltage, $V_{BDG}$	+145	V
Gate Voltage Range, $V_G$	-7 to +2	V
Drain Current, $I_{D_{MAX}}$	4.1	A
Gate Current Range, $I_G$	See page 15.	mA
Power Dissipation, $P_{DISS}^2$	30	W
RF Input Power, Pulse, 2.9 GHz, $T = 25\text{ }^\circ\text{C}^2$	+33	dBm
Mounting Temperature (30 Seconds)	320	$^\circ\text{C}$
Storage Temperature	-65 to +150	$^\circ\text{C}$

Notes:

1. Operation of this device outside the parameter ranges given above may cause permanent damage.
2. Pulsed 100uS PW, 20% DC

### Recommended Operating Conditions<sup>1</sup>

Parameter	Min	Typ	Max	Units
Operating Temp. Range	-40	+25	+85	$^\circ\text{C}$
Drain Voltage Range, $V_D$	+32	+50	+55	V
Drain Bias Current, $I_{DQ}$		52.5		mA
Drain Current, $I_D^4$	-	100	-	mA
Gate Voltage, $V_G^3$	-	-2.8	-	V
Power Dissipation ( $P_D$ ), Pulsed <sup>2,4</sup>	-	-	27	W
Power Dissipation ( $P_D$ ), CW <sup>2</sup>	-	-	18.5	W

Notes:

1. Electrical performance is measured under conditions noted in the electrical specifications table. Specifications are not guaranteed over all recommended operating conditions.
2. Package base at 85  $^\circ\text{C}$
3. To be adjusted to desired  $I_{DQ}$
4. 100uS PW, 20% DC

### Measured Load Pull Performance – Power Tuned<sup>1</sup>

Parameter	Typical Values			Units
	2.7	3.1	3.5	
Frequency, F	2.7	3.1	3.5	GHz
Drain Voltage, $V_D$	50	50	50	V
Drain Bias Current, $I_{DQ}$	52.5	52.5	52.5	mA
Output Power at 3dB compression, $P_{3dB}$	45.2	44.9	45	dBm
Drain Efficiency at 3dB compression, $DEFF_{3dB}$	57	55.3	58.2	%
Gain at 3dB compression, $G_{3dB}$	14	15.4	15.4	dB

Notes:

1. Pulsed, 100 uS Pulse Width, 20% Duty Cycle
2. Characteristic Impedance,  $Z_o = 33.4\ \Omega$ .

### Measured Load Pull Performance – Efficiency Tuned<sup>1</sup>

Parameter	Typical Values			Units
	2.7	3.1	3.5	
Frequency, F	2.7	3.1	3.5	GHz
Drain Voltage, $V_D$	50	50	50	V
Drain Bias Current, $I_{DQ}$	52.5	52.5	52.5	mA
Output Power at 3dB compression, $P_{3dB}$	43.6	43.6	43.9	dBm
Drain Efficiency at 3dB compression, $DEFF_{3dB}$	68	65.1	66.5	%
Gain at 3dB compression, $G_{3dB}$	16.5	17.5	16.3	dB

Notes:

1. Pulsed, 100 uS Pulse Width, 20% Duty Cycle
2. Characteristic Impedance,  $Z_o = 33.4\ \Omega$ .

## 2.7 – 3.1 GHz EVB 2.9 GHz Performance<sup>1</sup>

Parameter	Min	Typ	Max	Units
Linear Gain, $G_{LIN}$	–	17	–	dB
Output Power at 3dB compression point, P3dB	–	25	–	W
Drain Efficiency at 3dB compression point, DEFF3dB	–	57.6	–	%
Gain at 3dB compression point, G3dB	–	14	–	dB

Notes:

1.  $V_D = +50\text{ V}$ ,  $I_{DQ} = 52.5\text{ mA}$ , Temp =  $+25\text{ }^\circ\text{C}$ , Pulse Width = 128  $\mu\text{s}$ , Duty Cycle = 10%

## RF Characterization – Mismatch Ruggedness at 2.9 GHz

Symbol	Parameter	dB Compression	Typical
VSWR	Impedance Mismatch Ruggedness	3	10:1

Test conditions unless otherwise noted:  $T_A = 25\text{ }^\circ\text{C}$ ,  $V_D = 50\text{ V}$ ,  $I_{DQ} = 52.5\text{ mA}$ , Pulsed, 128  $\mu\text{s}$  Pulse Width, 10% Duty Cycle  
 Input drive power is determined at pulsed 3dB compression under matched condition at EVB output connector.

Measured Load-Pull Smith Charts<sup>1,2</sup>

Notes:

1. Test Conditions:  $V_D = 50\text{ V}$ ,  $I_{DQ} = 52.5\text{ mA}$ , 100  $\mu\text{s}$  Pulse Width, 20% Duty Cycle
2. See page 15 for load pull reference planes where the performance was measured.

2.7GHz, Load-pull

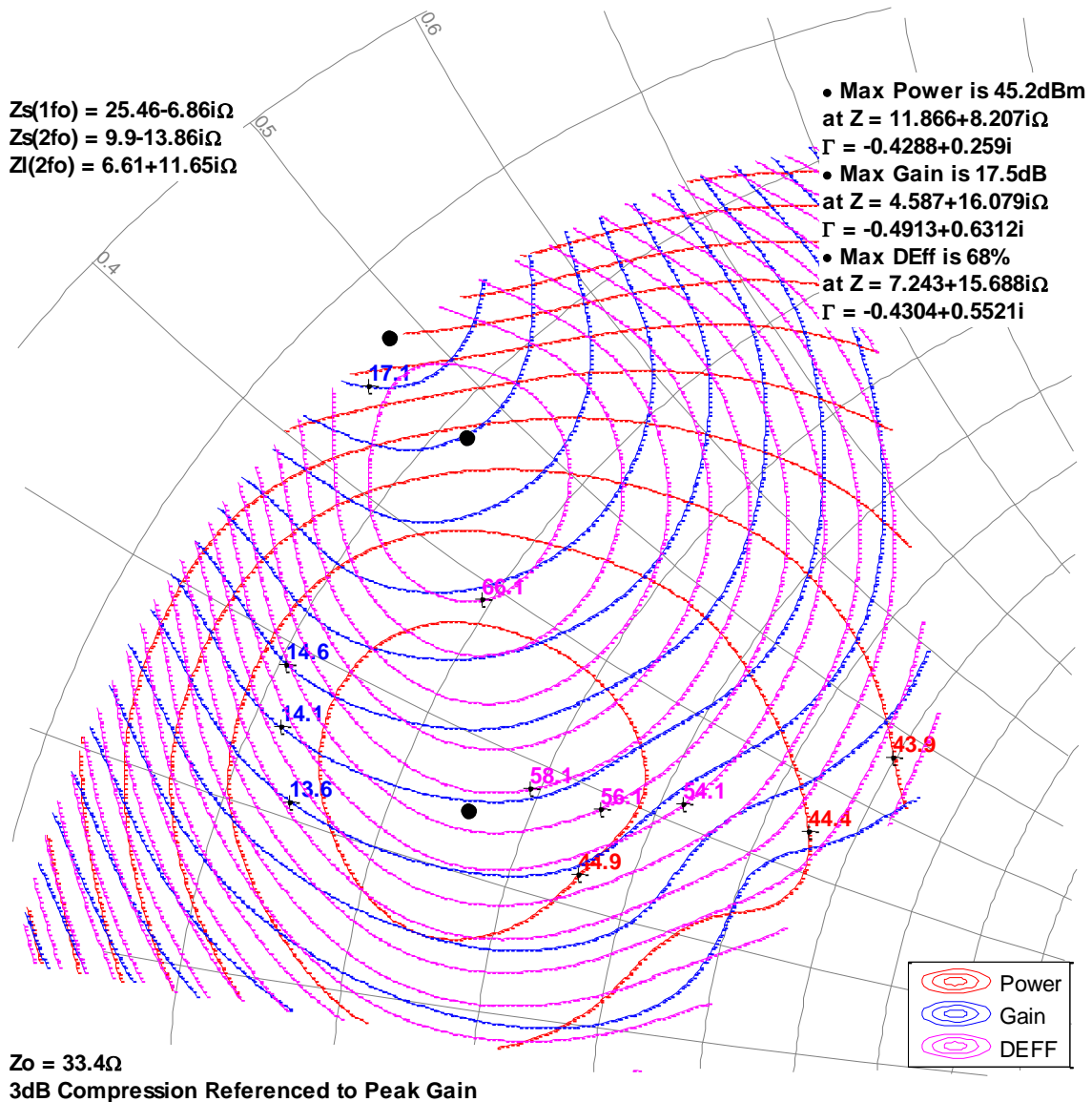

Measured Load-Pull Smith Charts<sup>1,2</sup>

Notes:

1. Test Conditions:  $V_D = 50\text{ V}$ ,  $I_{DQ} = 52.5\text{ mA}$ , 100 uS Pulse Width, 20% Duty Cycle
2. See page 15 for load pull reference planes where the performance was measured.

3.1GHz, Load-pull

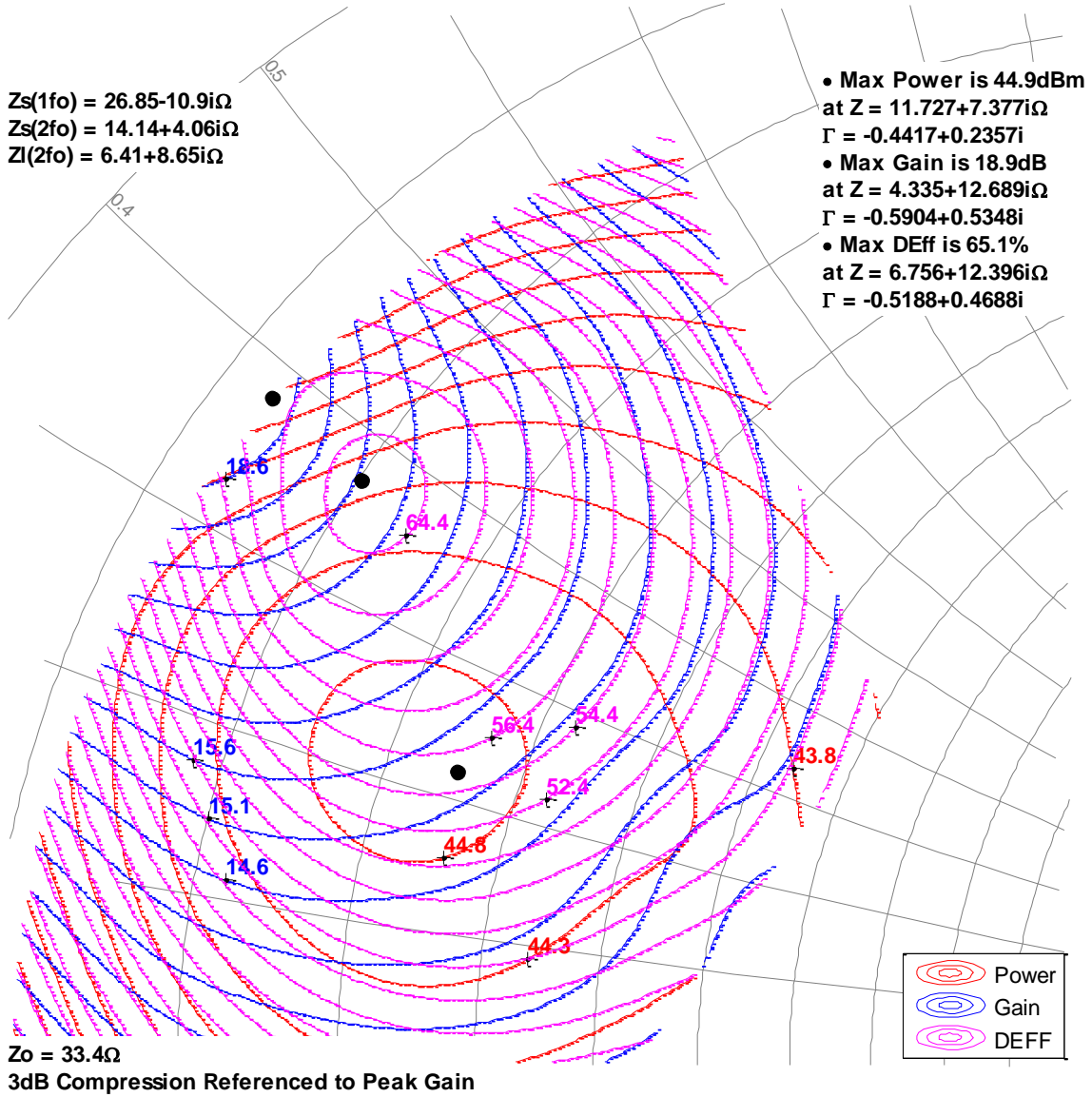

Measured Load-Pull Smith Charts<sup>1,2</sup>

Notes:

1. Test Conditions:  $V_D = 50\text{ V}$ ,  $I_{DQ} = 52.5\text{ mA}$ , 100 uS Pulse Width, 20% Duty Cycle
2. See page 15 for load pull reference planes where the performance was measured.

3.5GHz, Load-pull

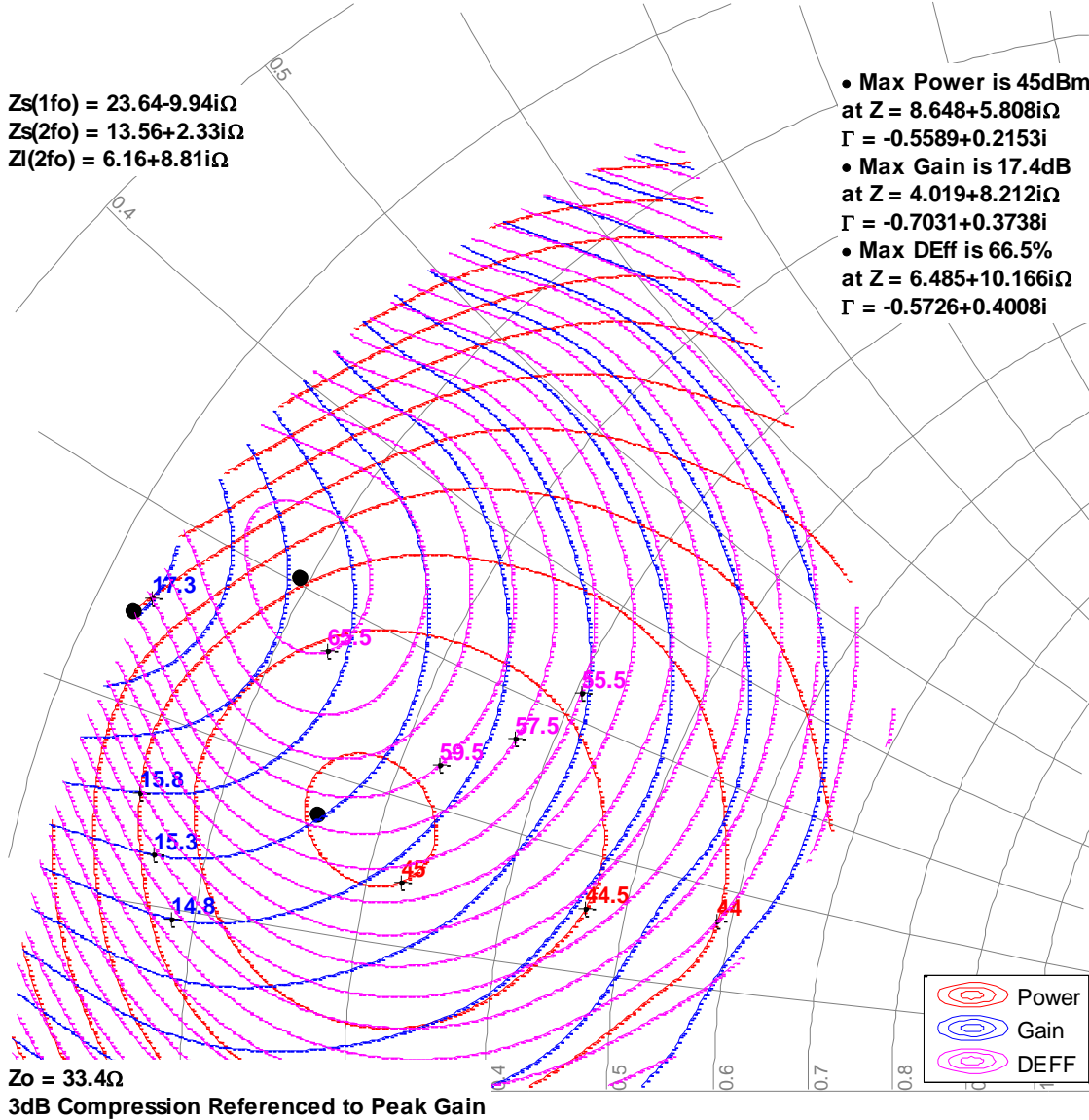

Typical Measured Performance – Load-Pull Drive-up<sup>1, 2</sup>

Notes:

1. Test Conditions:  $V_D = 50\text{ V}$ ,  $I_{DQ} = 52.5\text{ mA}$ , 100  $\mu\text{s}$  Pulse Width, 20% Duty Cycle
2. See page 15 for load-pull and source-pull reference planes where the performance was measured.

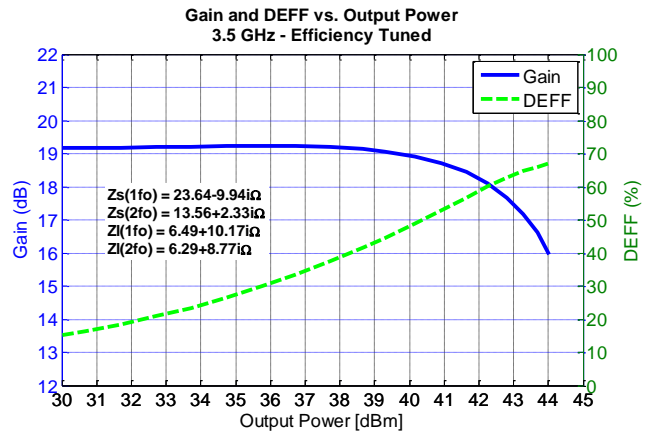
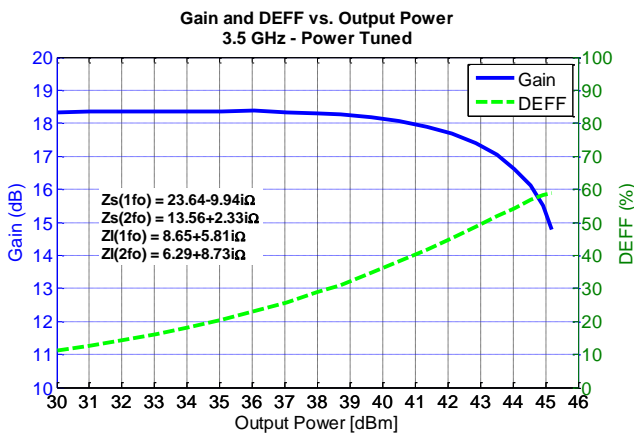
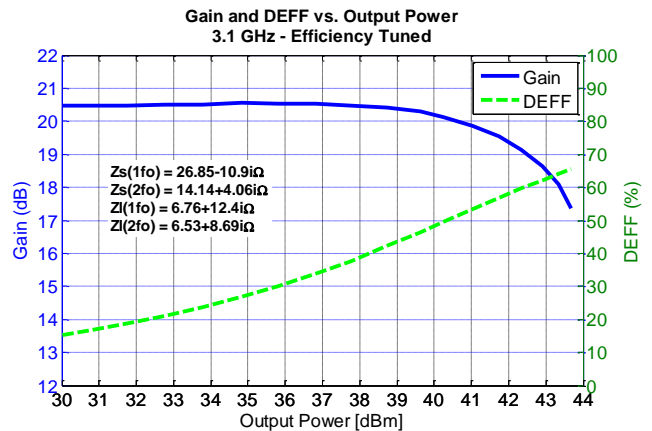
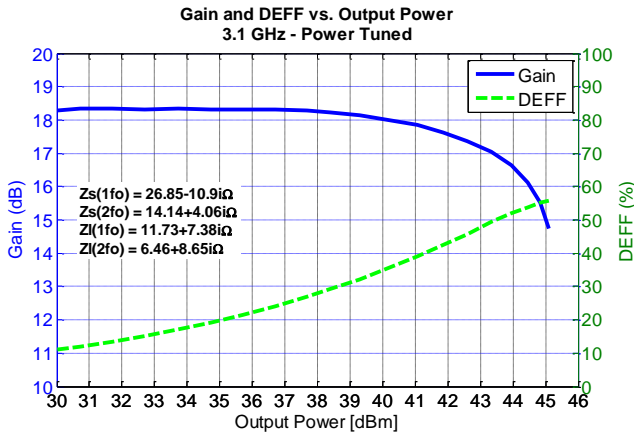
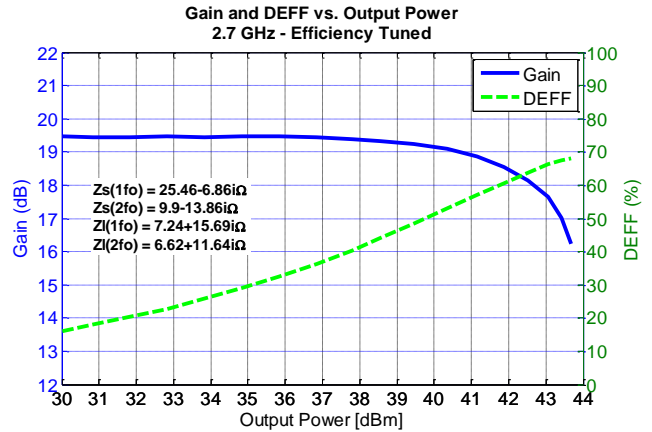
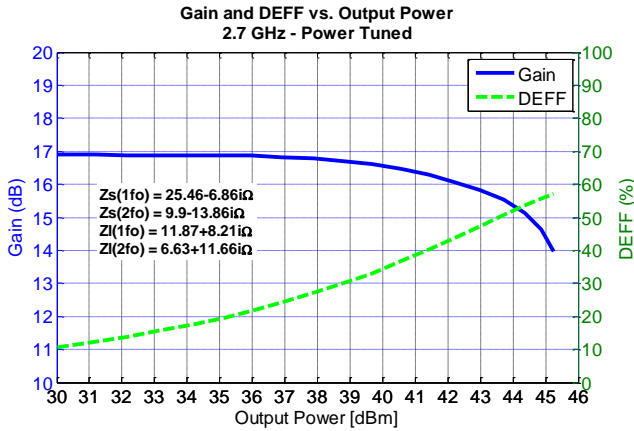

### Power Driveup Performance Over Temperatures Of 2.7 – 3.1 GHz EVB<sup>1</sup>

Notes:

1. Test Conditions:  $V_D = 50\text{ V}$ ,  $I_{DQ} = 52.5\text{ mA}$ , 128  $\mu\text{s}$  Pulse Width, 10% Duty Cycle

**P3dB Over Temperatures**

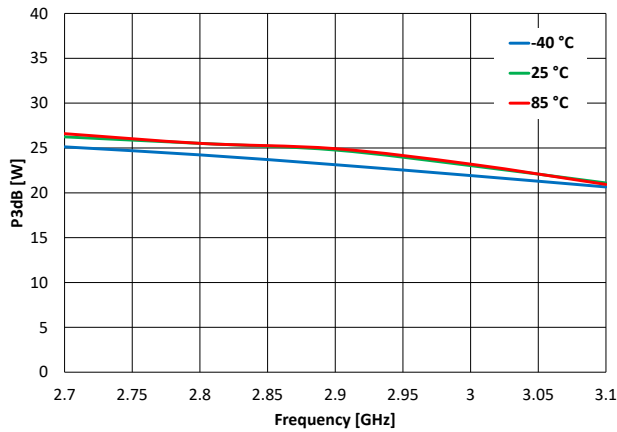

**DEFF3dB Over Temperatures**

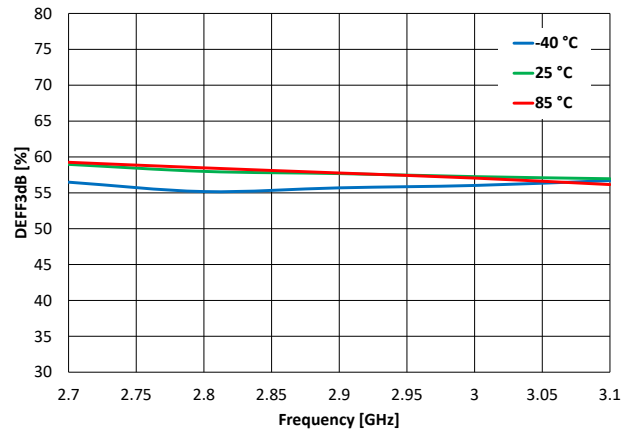

**G3dB Over Temperatures**

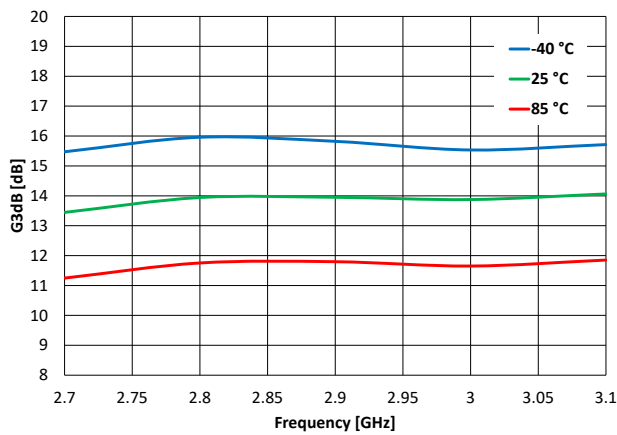

**Pdiss3dB Over Temperatures**

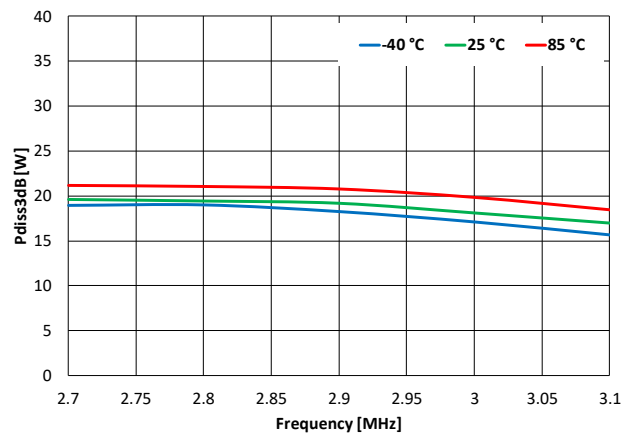



### Power Driveup Performance At 25°C Of 2.7 – 3.1 GHz EVB<sup>1, 2</sup>

Notes:

1. Test Conditions:  $V_D = 50\text{ V}$ ,  $I_{DQ} = 52.5\text{ mA}$ , 128  $\mu\text{s}$  Pulse Width, 10% Duty Cycle

**P3dB At 25 °C**

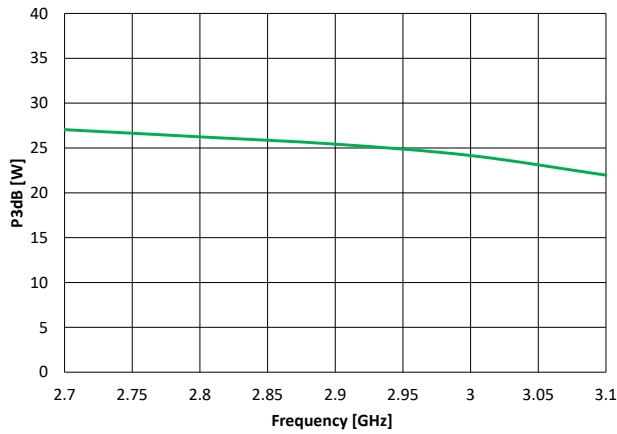

**DEFF3dB At 25 °C**

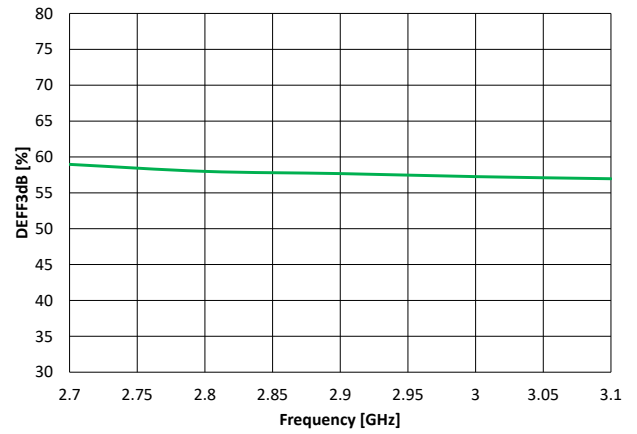

**G3dB At 25 °C**

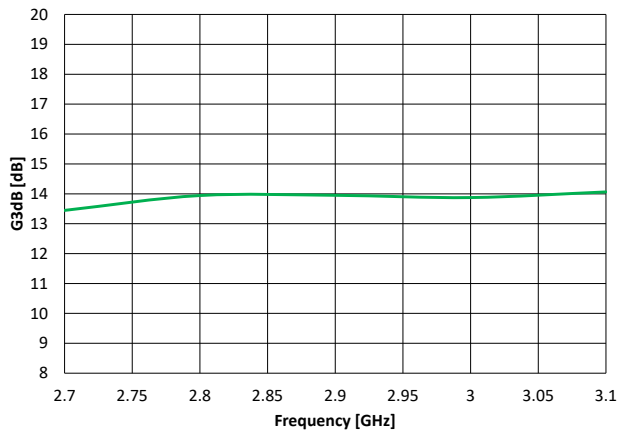

**Pdiss3dB At 25 °C**

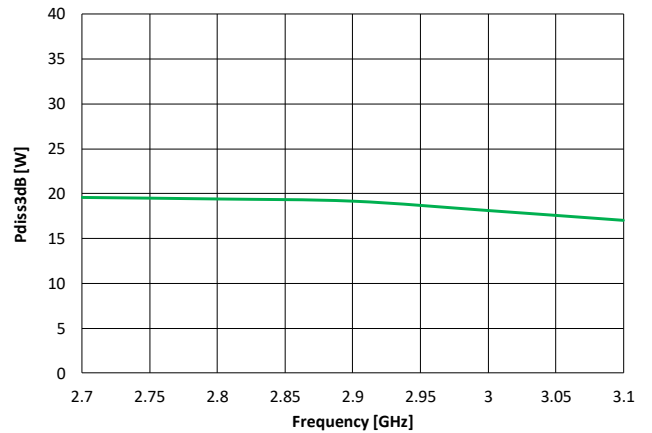

### 2-Tone 2.9 GHz Performance At 25°C Of 2.7 – 3.1 GHz EVB<sup>1,2</sup>

Notes:

- 1. Test Conditions:  $V_D = 50\text{ V}$ ,  $I_{DQ} = 52.5\text{ mA}$
- 2. Tone spacing = 1 MHz.

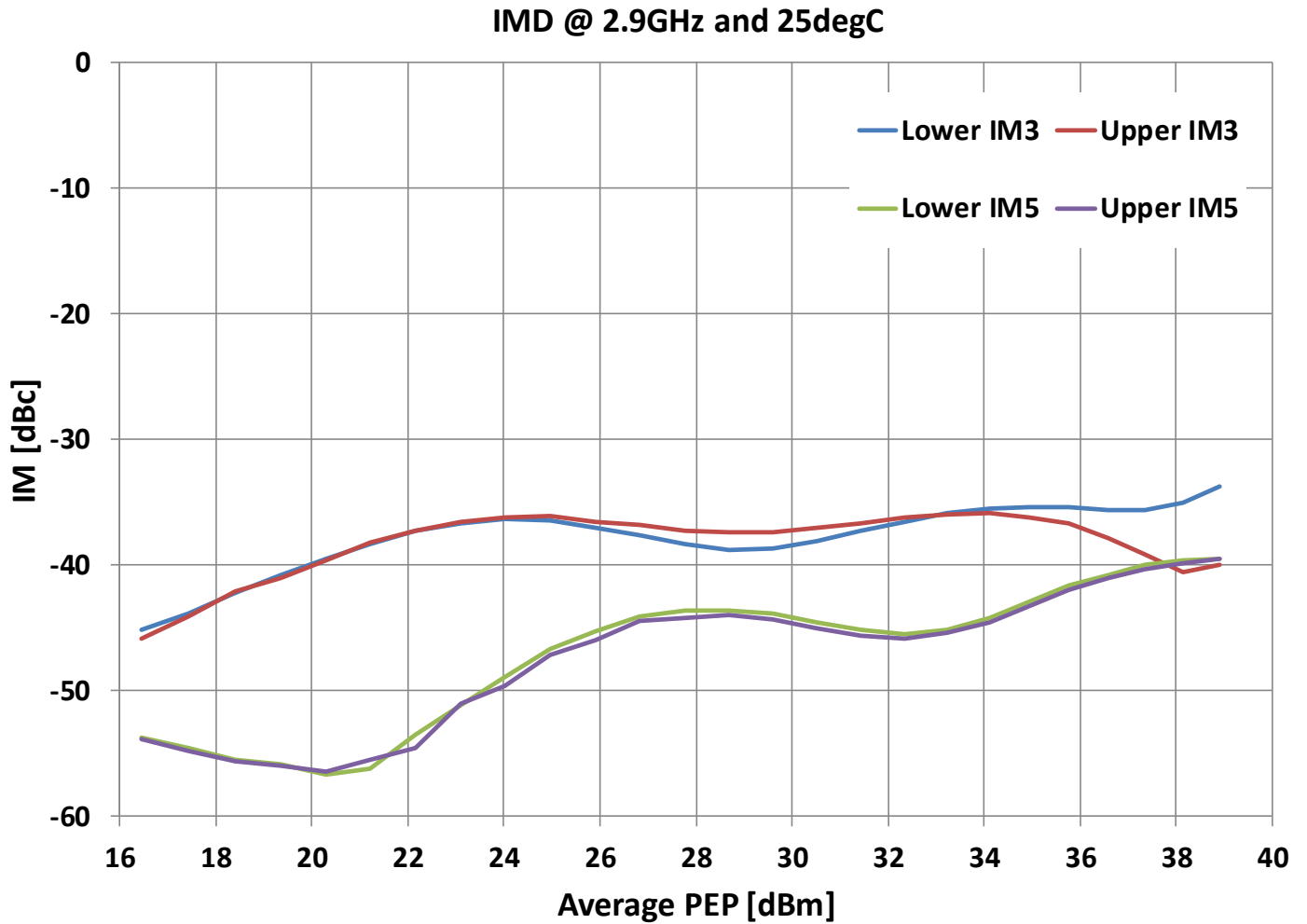

### Small Signal Performance At 25°C Of 2.7 – 3.1 GHz EVB<sup>1,2</sup>

Notes:

1. Test Conditions:  $V_D = 50\text{ V}$ ,  $I_{DQ} = 52.5\text{ mA}$
2. K factor > 1 indicates unconditional stability.

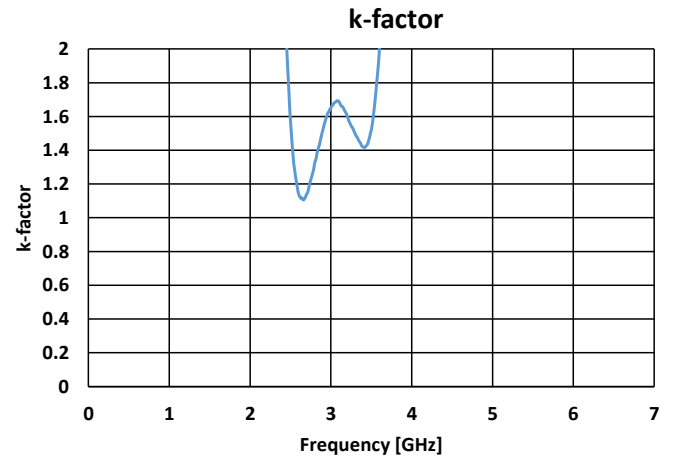
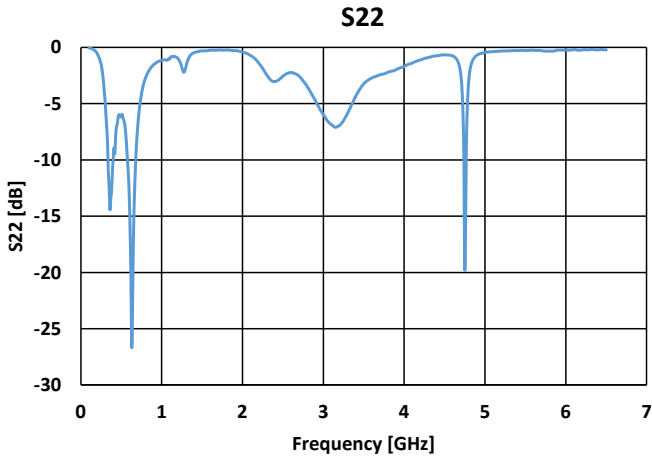
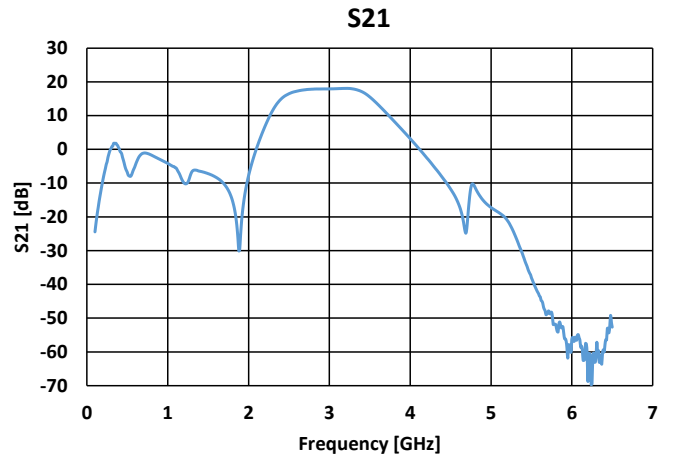
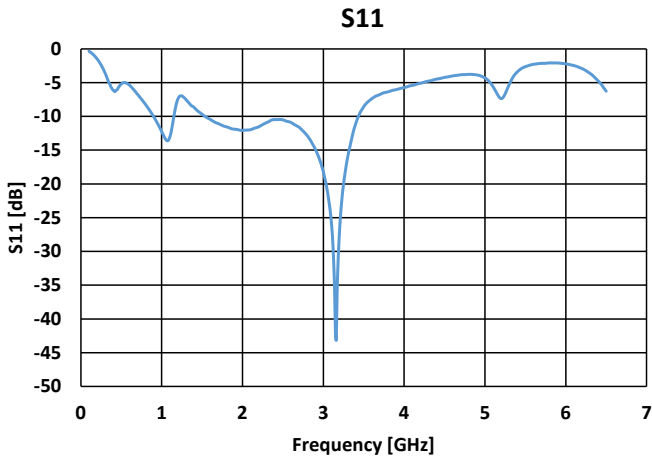

## Thermal and Reliability Information – Pulsed

Peak IR Surface Temperature vs. Pulse Width vs. Dissipation Power  
20% Duty Cycle, QFN base fixed at 85 °C

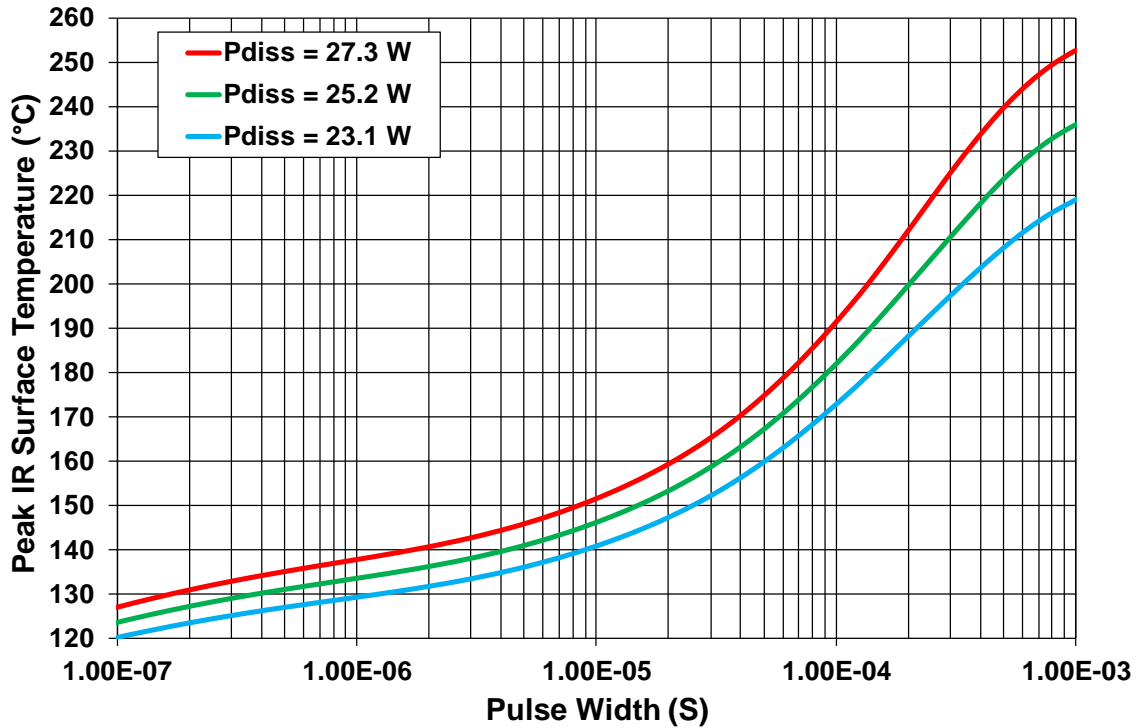

Parameter	Conditions	Values	Units
Thermal Resistance, IR <sup>1</sup> ( $\theta_{JC}$ )	85 °C Case	3.79	°C/W
Peak IR Surface Temperature <sup>1</sup> ( $T_{CH}$ )	23.1 W P <sub>diss</sub> , 100 uS PW, 20% DC	173	°C
Thermal Resistance, IR <sup>1</sup> ( $\theta_{JC}$ )	85 °C Case	3.84	°C/W
Peak IR Surface Temperature <sup>1</sup> ( $T_{CH}$ )	25.2 W P <sub>diss</sub> , 100 uS PW, 20% DC	182	°C
Thermal Resistance, IR <sup>1</sup> ( $\theta_{JC}$ )	85 °C Case	3.89	°C/W
Peak IR Surface Temperature <sup>1</sup> ( $T_{CH}$ )	27.3 W P <sub>diss</sub> , 100 uS PW, 20% DC	191	°C

Notes:

<sup>1</sup>Refer to the following document [GaN Device Channel Temperature, Thermal Resistance, and Reliability Estimates](#)

### Thermal and Reliability Information - CW

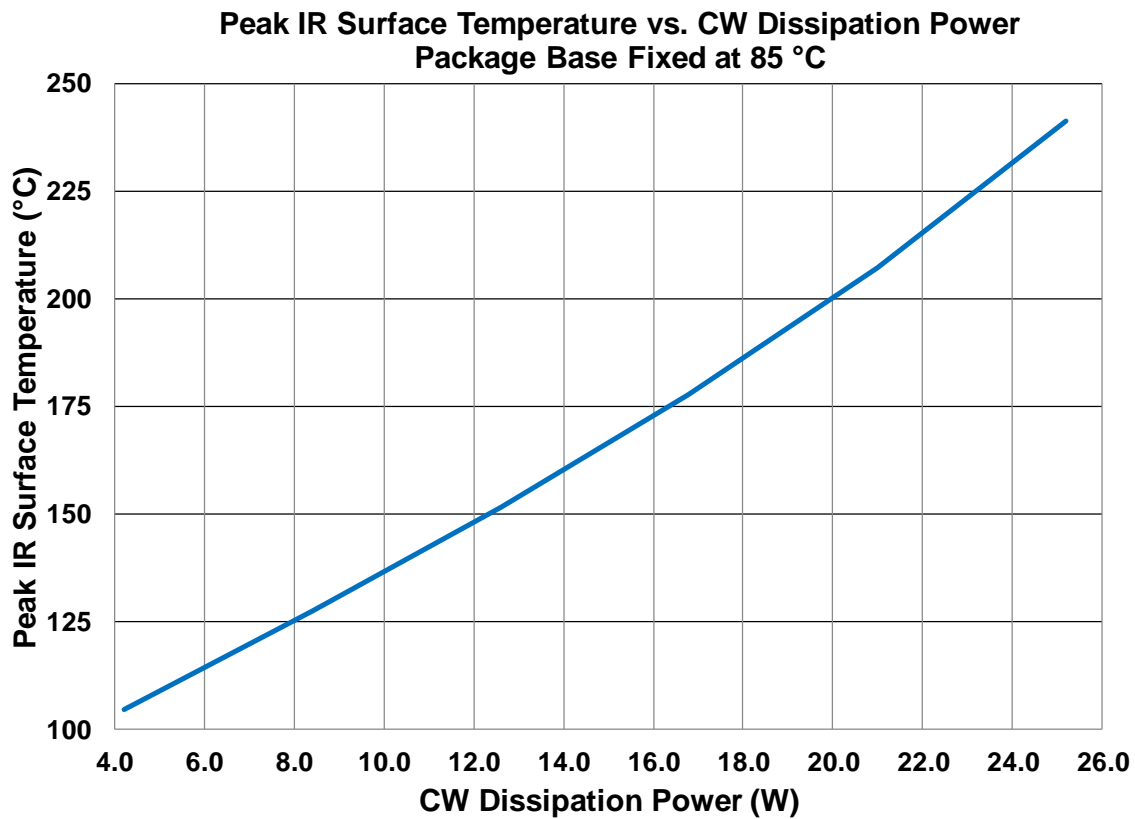

Parameter	Conditions	Values	Units
Thermal Resistance, IR <sup>1</sup> ( $\theta_{JC}$ )	85 °C Case	5.29	°C/W
Peak IR Surface Temperature <sup>1</sup> ( $T_{CH}$ )	12.6 W Pdiss, CW	152	°C
Thermal Resistance, IR <sup>1</sup> ( $\theta_{JC}$ )	85 °C Case	5.52	°C/W
Peak IR Surface Temperature <sup>1</sup> ( $T_{CH}$ )	16.8 W Pdiss, CW	178	°C
Thermal Resistance, IR <sup>1</sup> ( $\theta_{JC}$ )	85 °C Case	5.82	°C/W
Peak IR Surface Temperature <sup>1</sup> ( $T_{CH}$ )	21 W Pdiss, CW	207	°C

Notes:

<sup>1</sup>Refer to the following document [GaN Device Channel Temperature, Thermal Resistance, and Reliability Estimates](#)

Maximum Gate Current

Maximum Gate Current Vs. Peak IR Surface Temperature

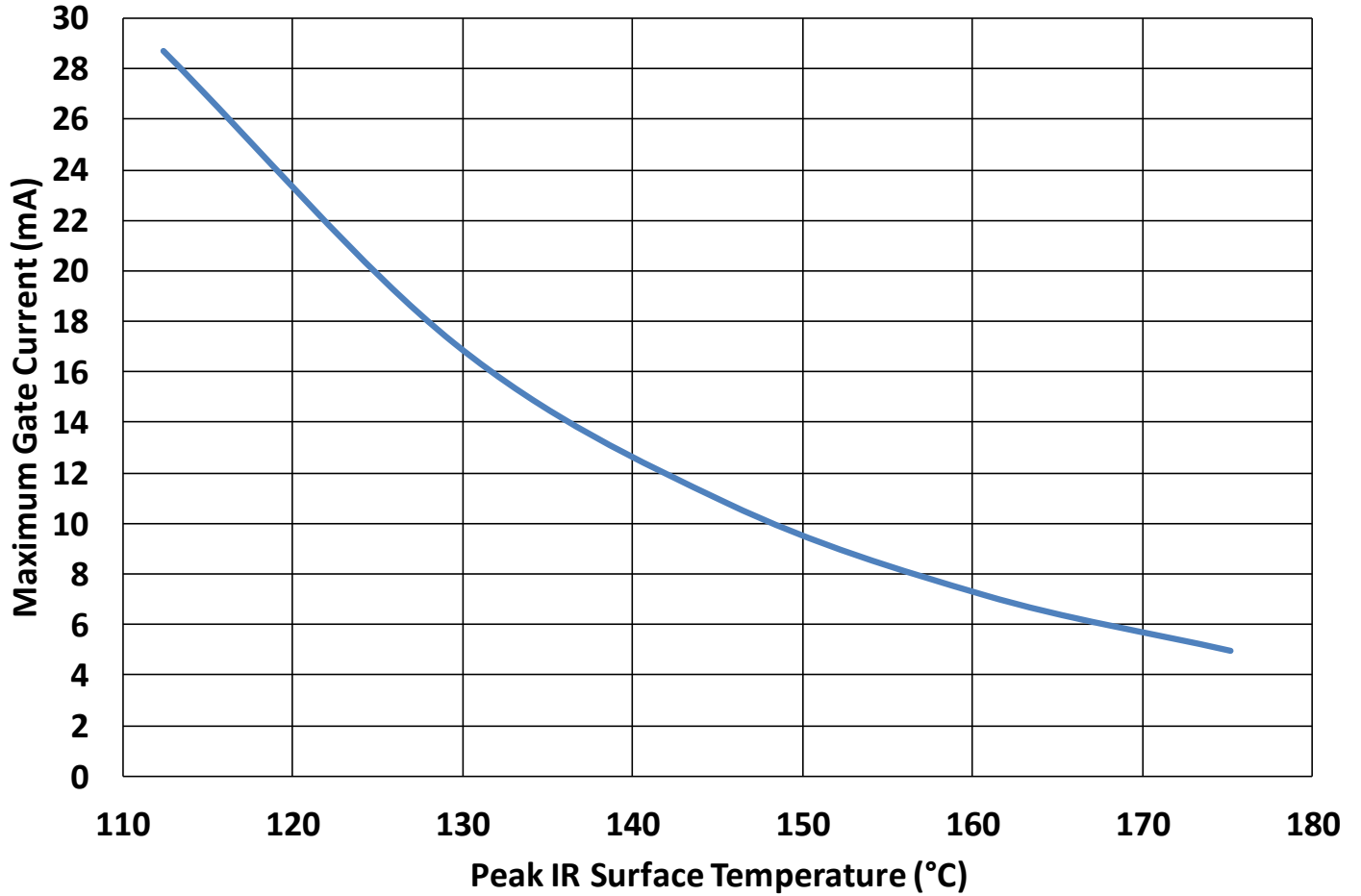

### Pin Configuration and Description<sup>1</sup>

Note 1: The QPD1020 will be marked with the “QPD1020” designator and a lot code marked below the part designator. The “YY” represents the last two digits of the calendar year the part was manufactured, the “WW” is the work week of the assembly lot start, the MXXX” is the production lot number, and the “ZZZ” is an auto-generated serial number.

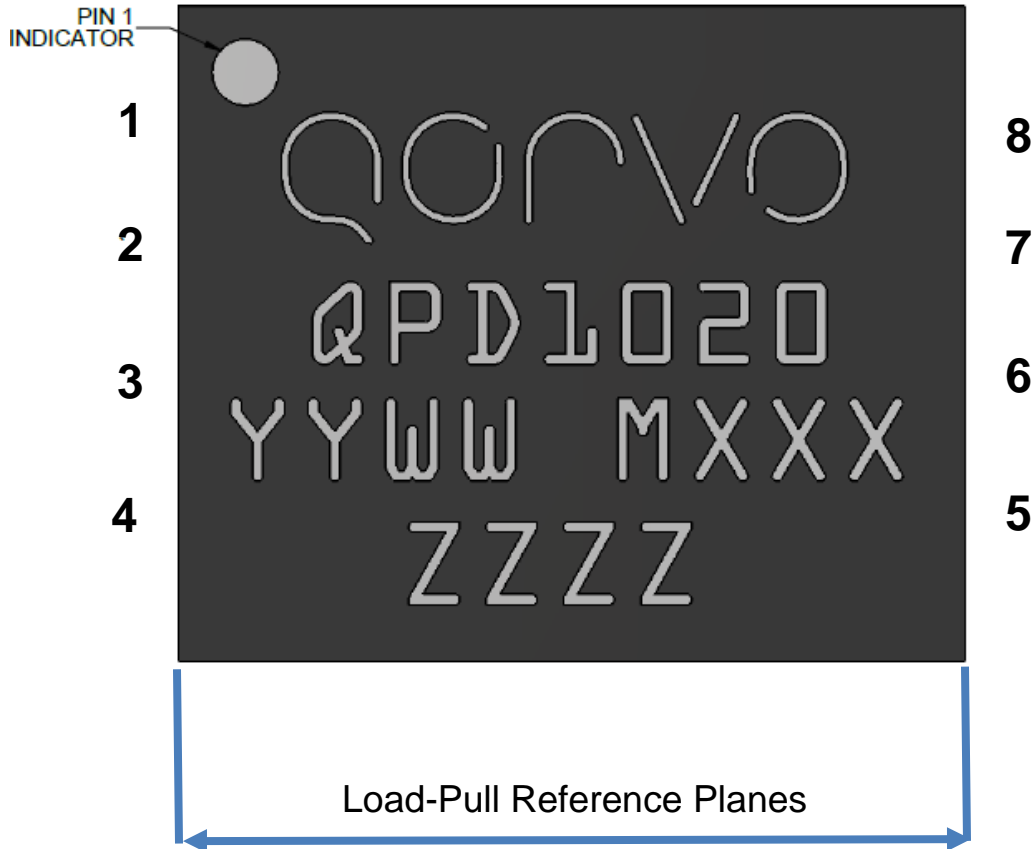

Pin	Symbol	Description
2, 3	RF IN / $V_G$	Gate
6, 7	RF OUT / $V_D$	Drain
1, 4, 5, 8	N/C	No Connection
9	Source	Source / Ground / Backside of part (See next page.)

Mechanical Drawing<sup>1</sup>

Note 1:

1. Dimensions are in mm. Dimension tolerance is  $\pm 0.1$  mm, unless otherwise noted.
2. Package exposed metallization is gold plated.
3. Part is overmold encapsulated.

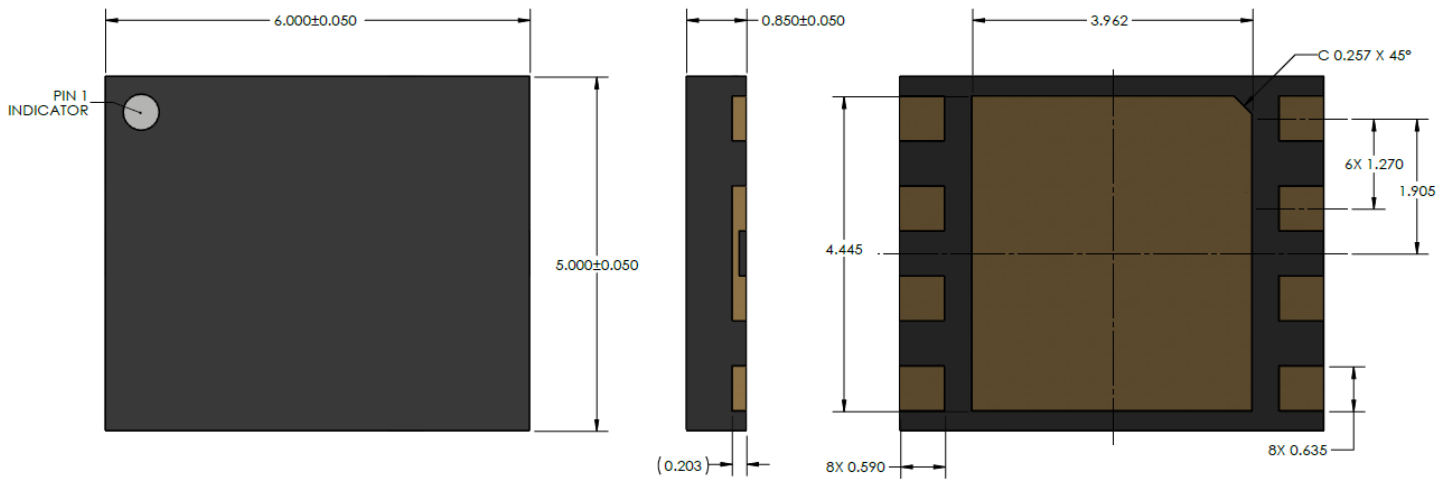



### 2.7 – 3.1 GHz Application Circuit - Schematic

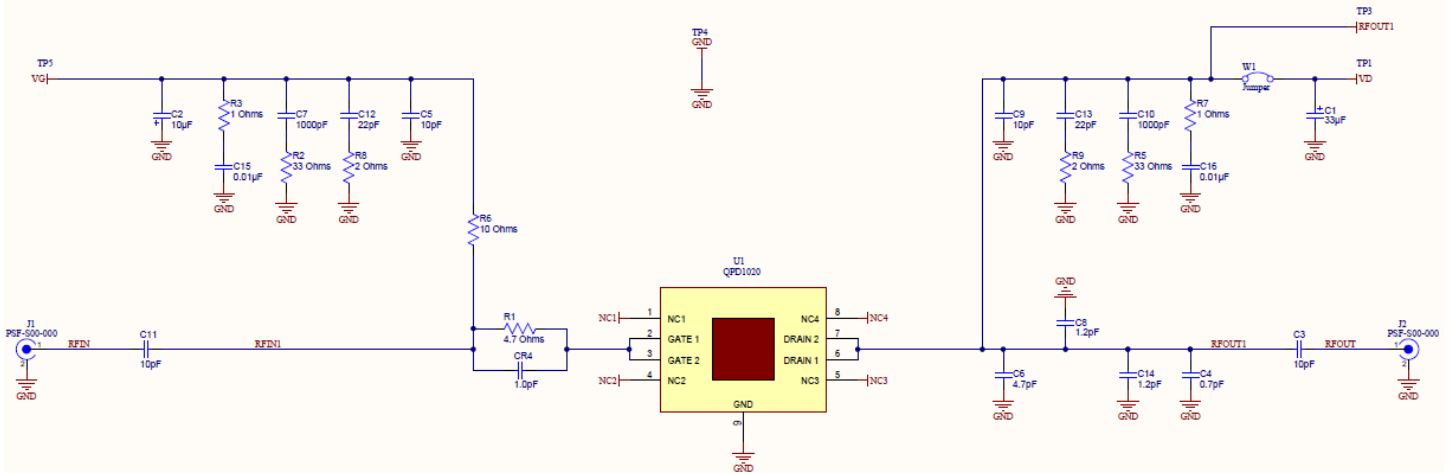

Bias-up Procedure	Bias-down Procedure
1. Set $V_G$ to -4 V.	1. Turn off RF signal.
2. Set $I_D$ current limit to 60 mA.	2. Turn off $V_D$
3. Apply 50 V $V_D$ .	3. Wait 2 seconds to allow drain capacitor to discharge
4. Slowly adjust $V_G$ until $I_D$ is set to 52.5 mA.	4. Turn off $V_G$
5. Set $I_D$ current limit to 120 mA (Pulsed operation)	
6. Apply RF.	

### 2.7 – 3.1 GHz Application Circuit - Layout

Board material is RO4350B 0.020" thickness with 2oz copper cladding. Overall EVB size is 1.58" x 2.48".

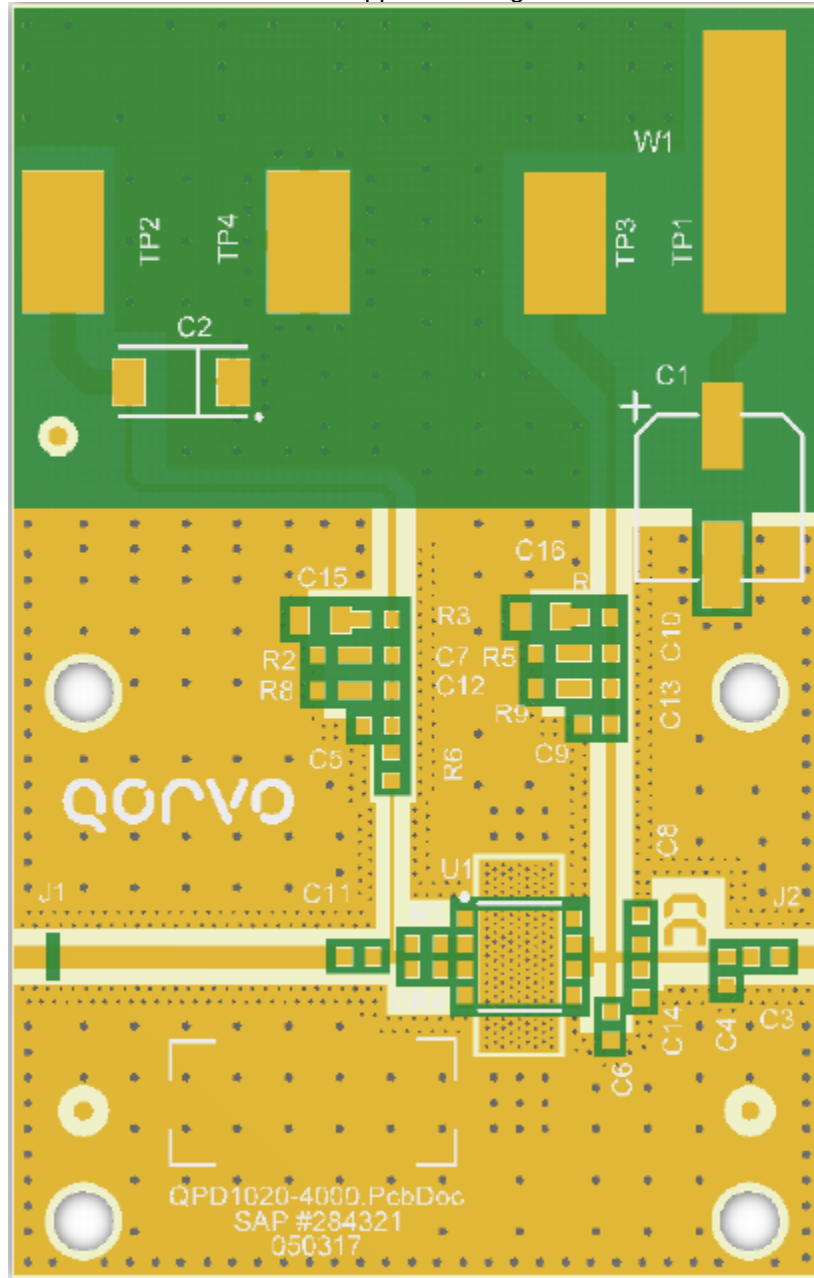

**2.7 – 3.1 GHz Application Circuit - Bill Of material**

Description	Ref. Des.	Manufacturer	Part Number
Cap 10 UF +/-10% 16V LOW ESR TANT	C2	AVX	TPSC106K016R0500
CAP, 1000pF,100V, 10%, X7R, 0603	C7, C10	AVX	06031C102KAT2A
CAP 0.01 UF,100V,5%,X7R,LF,0805	C15, C16	TTI	08051C103JAT2A
CAP, 4.7 PF, 250V,0603,LF +/- .1P	C6	ATC	600S4R7BT250XT
CAP, 10PF,250V,1%,0603	C3, C5, C9, C11	ATC	600S100FT250XT
CAP, 1.0pF, +/-0.05pF, 250V, HI-Q	CR4	ATC	600S1R0AT250XT
CAP, 0.7pF, +/-0.05pF, 250V, HI-Q	C4	ATC	600S0R7AT250XT
CAP, 22pF, +/-5%, 250V, HI-Q, 0603	C12, C13	ATC	600S220JT250XT
CAP, 33uF, 20%, 80V, ALUM ELEC,8mm SMD	C1	Panasonic	EEE-FK1K330P
CAP, 1.2pF, +/-0.05pF, 250V, C0G	C8, C14	ATC	600S1R2AT250XT
RES, 2 OHM, 1%, 1/10W, 0603	R8, R9	Vishay	CRCW06032R00FKEA
RES, 1 OHM, 1%, 1/10, 0603	R3, R7	Samsung	RC1608F1ROCS
33 OHM,5%,0.1W,0603,LEAD FREE	R2, R5	KOA	RK73B1JTDD330J
10 OHM,1%,0.1W,0603,LEAD FREE	R6	KOA	RK73H1JTDD10R0F
CONN, SMA, 4-HOLE PANEL MOUNT	J1, J2	Gigalane	PSF-S00-000

Recommended Solder Temperature Profile

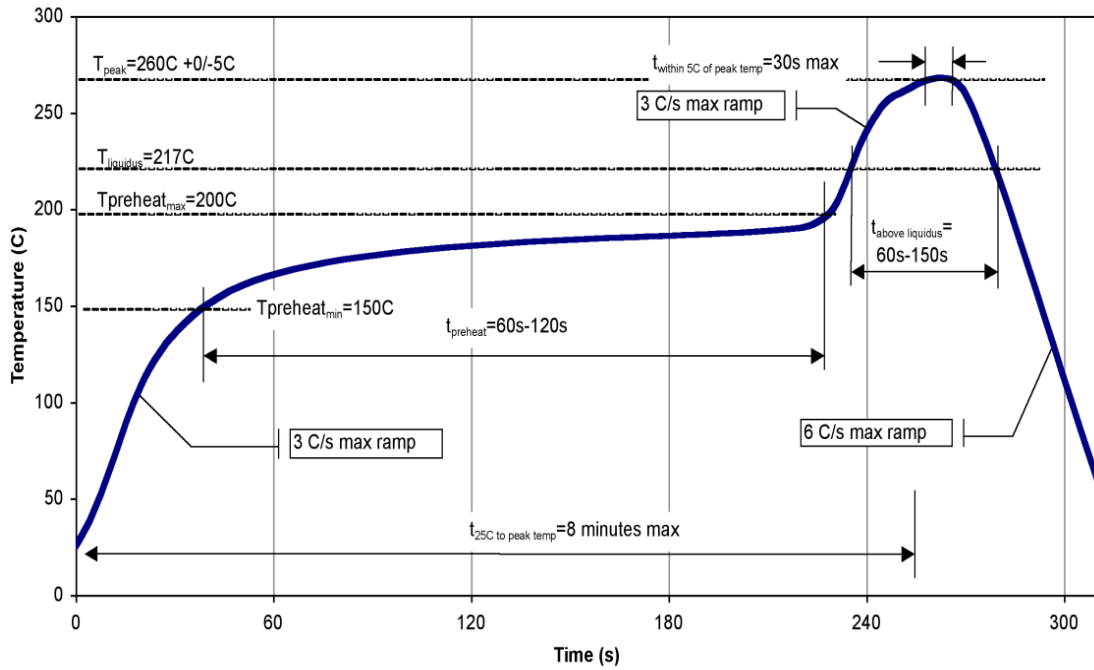

### Handling Precautions

Parameter	Rating	Standard
ESD – Human Body Model (HBM)	Class 1A, > 400V	ANSI/ESD/JEDEC JS-001
ESD – Charged Device Model (CDM)	TBD	ANSI/ESD/JEDEC JS-002
MSL – Moisture Sensitivity Level	TBD	JESD J-STD-020



Caution!  
ESD-Sensitive Device

### Solderability

Compatible with both lead-free (260°C max. reflow temp.) and tin/lead (245°C max. reflow temp.) soldering processes. Solder profiles available upon request.

Contact plating: NiPdAu

### RoHS Compliance

This part is compliant with 2011/65/EU RoHS directive (Restrictions on the Use of Certain Hazardous Substances in Electrical and Electronic Equipment) as amended by Directive 2015/863/EU.

This product also has the following attributes:

- Lead Free
- Halogen Free (Chlorine, Bromine)
- Antimony Free
- TBBP-A (C<sub>15</sub>H<sub>12</sub>Br<sub>4</sub>O<sub>2</sub>) Free
- PFOS Free
- SVHC Free



### Contact Information

For the latest specifications, additional product information, worldwide sales and distribution locations, and information about Qorvo:

Web: [www.qorvo.com](http://www.qorvo.com)      Tel: +1.844.890.8163  
 Email: [customer.support@qorvo.com](mailto:customer.support@qorvo.com)

For technical questions and application information:      Email: [info-products@qorvo.com](mailto:info-products@qorvo.com)

### Important Notice

The information contained herein is believed to be reliable; however, Qorvo makes no warranties regarding the information contained herein and assumes no responsibility or liability whatsoever for the use of the information contained herein. All information contained herein is subject to change without notice. Customers should obtain and verify the latest relevant information before placing orders for Qorvo products. The information contained herein or any use of such information does not grant, explicitly or implicitly, to any party any patent rights, licenses, or any other intellectual property rights, whether with regard to such information itself or anything described by such information. **THIS INFORMATION DOES NOT CONSTITUTE A WARRANTY WITH RESPECT TO THE PRODUCTS DESCRIBED HEREIN, AND QORVO HEREBY DISCLAIMS ANY AND ALL WARRANTIES WITH RESPECT TO SUCH PRODUCTS WHETHER EXPRESS OR IMPLIED BY LAW, COURSE OF DEALING, COURSE OF PERFORMANCE, USAGE OF TRADE OR OTHERWISE, INCLUDING THE IMPLIED WARRANTIES OF MERCHANTABILITY AND FITNESS FOR A PARTICULAR PURPOSE.**

Without limiting the generality of the foregoing, Qorvo products are not warranted or authorized for use as critical components in medical, life-saving, or life-sustaining applications, or other applications where a failure would reasonably be expected to cause severe personal injury or death.

Copyright 2016 © Qorvo, Inc. | Qorvo is a registered trademark of Qorvo, Inc.

## X-ON Electronics

Largest Supplier of Electrical and Electronic Components

*Click to view similar products for [RF MOSFET Transistors](#) category:*

*Click to view products by [Qorvo](#) manufacturer:*

Other Similar products are found below :

[MRF492](#) [MRFE8VP8600HR5](#) [ARF1511](#) [ARF465BG](#) [BF 2030 E6814](#) [BLF861A](#) [DU1215S](#) [DU28200M](#) [UF28100M](#) [DU2820S](#)  
[MHT1008NT1](#) [MMRF1014NT1](#) [MRF426](#) [ARF468AG](#) [ARF468BG](#) [MAPHST0045](#) [MRFE6VP61K25NR6](#) [DU2860U](#) [VRF152GMP](#)  
[MRFE6VP5300NR1](#) [BF2040E6814HTSA1](#) [MRFE6VP5150GNR1](#) [LET9060S](#) [MRF136Y](#) [BF999E6327HTSA1](#) [SD2931-12MR](#)  
[BF998E6327HTSA1](#) [AFV10700HR5](#) [MRF141](#) [MRF171](#) [MRF172](#) [MRF174](#) [QPD1020SR](#) [BF 1005S E6327](#) [MRF134](#) [MRF136](#) [MRF137](#)  
[MRF141G](#) [MRF151A](#) [MRF151G](#) [MRF157](#) [MRF158](#) [MRF160](#) [MRF171A](#) [MRF177](#) [UF2840G](#) [TGF3021-SM](#) [ARF1510](#) [ARF448BG](#)  
[ARF449AG](#)