

### Product Description

The QPD3601 is a discrete GaN on SiC HEMT which operates from 3.4 to 3.6 GHz. The device is a single stage matched power amplifier transistor.

The QPD3601 can be used in Doherty architecture for the final stage of a base station power amplifier for macrocell high efficiency systems.

QPD3601 can deliver  $P_{SAT}$  of 206 W at +50 V operation.

RoHS compliant.

### Functional Block Diagram

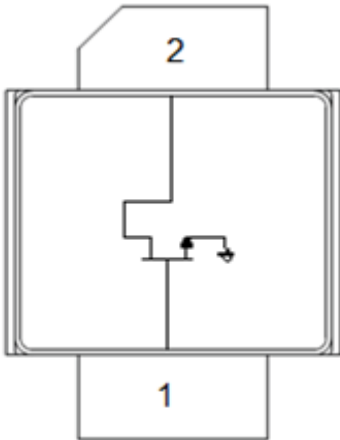

2 Lead NI400 Package

### Product Features

- Operating Frequency Range: 3.4 – 3.6 GHz
- Operating Drain Voltage: +50 V
- Output Power ( $P_{SAT}$ ): 206 W
- Drain Efficiency: 57.9%
- Efficiency-Tuned P3dB Gain: 16.3 dB
- 2-lead, earless, ceramic flange NI400 package

### Applications

- W-CDMA / LTE
- Macrocell Base Station
- Active Antenna

### Ordering Information

Part No.	Description
QPD3601	200 W, 3.4 – 3.6 GHz, GaN Discrete
QPD3601-EVB	3.4-3.6 GHz Evaluation Board

### Absolute Maximum Ratings

Parameter	Value / Range
Gate Voltage ( $V_G$ )	-10 V
Drain Voltage ( $V_D$ )	+55 V
Maximum RF Input Power	42 dBm
VSWR Mismatch, P1dB Pulse (20 % duty cycle, 100 $\mu$ width), T = 25 °C	10:1
Storage Temperature	-65 to +150°C

Operation of this device outside the parameter ranges given above may cause permanent damage.

### Recommended Operating Conditions

Parameter	Min	Typ	Max	Units
Gate Current ( $I_G$ )			15	mA
Gate Voltage ( $V_G$ )	-3.3	-2.7	-2.5	V
Drain Voltage ( $V_D$ )		50		V
Quiescent Current ( $I_{DQ}$ )		360		mA

Electrical performance is measured under conditions noted in the electrical specifications table. Specifications are not guaranteed over all recommended operating conditions.

### Electrical Specifications

Parameter	Conditions	Min	Typ	Max	Units
Frequency Range		3400		3600	MHz
Quiescent Current			360		mA
Gain	P3dB	15.0	16.3		dB
P3dB		52.5	53.1		dBm
Drain Efficiency	P3dB	51.0	57.9		%
Gate Leakage	$V_D = +50$ V, $V_G = -5$ V	-10.0	-3.5		mA

Test conditions unless otherwise noted:  $V_D = +50$  V,  $I_{DQ} = 360$  mA, T = 25°C, Pulsed (10 % duty cycle, 100  $\mu$ s width), on Class AB single-ended EVB at 3500 MHz

### Thermal and Reliability Information

Parameter	Test Conditions	Value	Units
Thermal Resistance, Peak IR Surface Temperature at Average Power ( $\theta_{JC}$ )	$T_{CASE} = 85^\circ\text{C}$ , $T_{CH} = 134^\circ\text{C}$ CW: $P_{DISS} = 51$ W, $P_{OUT} = 45$ W	0.96	°C/W

Notes:

1. Thermal resistance measured to package backside.
2. Based on expected carrier amplifier efficiency of Doherty.
3. Pout assumes 20% peaking amplifier contribution of total average Doherty rated power.
4. Refer to the following document: [GaN Device Channel Temperature, Thermal Resistance, and Reliability Estimate](#)

**Single-Ended Evaluation Board Layout**

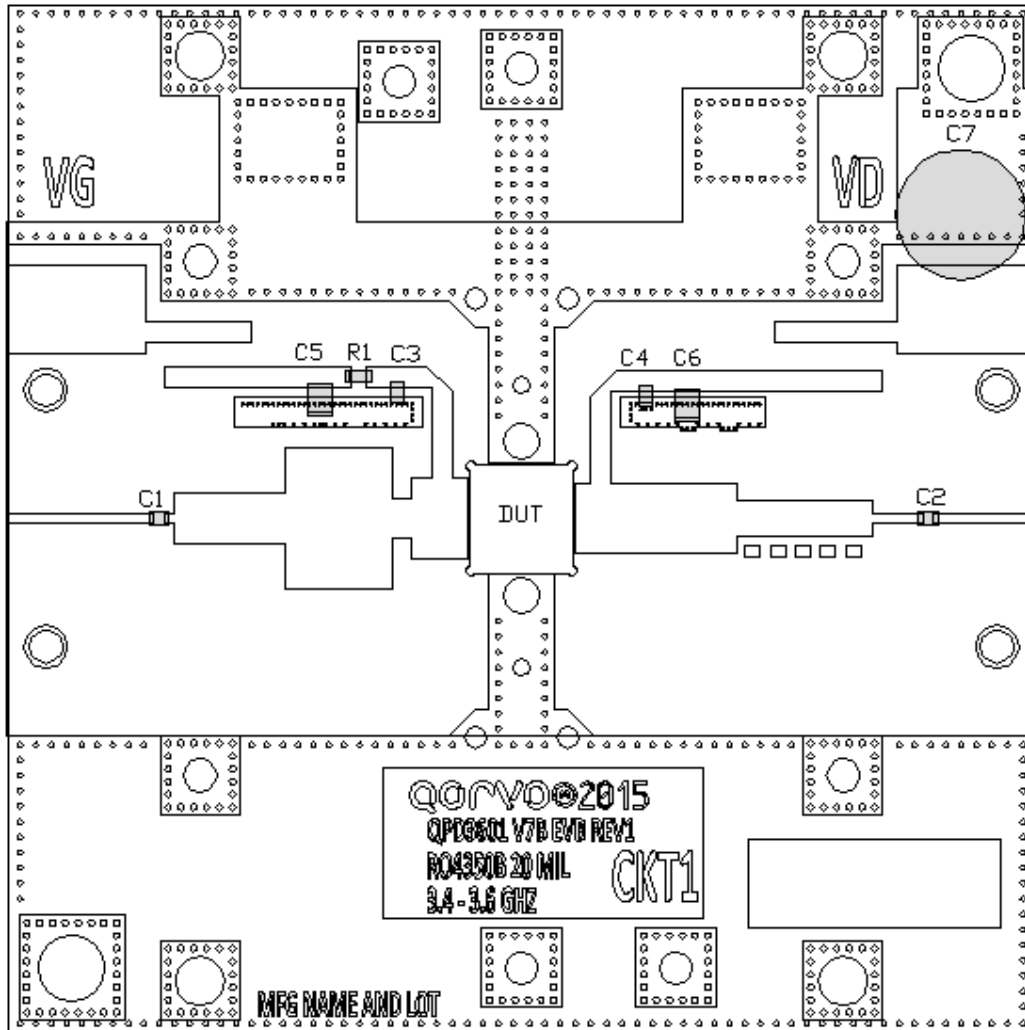

**Bill of Materials**

Reference	Value	Description	Manuf.	Part Number
C1, C2, C3, C4	8.2 pF	Capacitor, 8.2 pF	ATC	600F8R2BW250T
C5	10 μF	Capacitor, 10 μF, 50 V	TDK	C5750X7R1H106K230KB
C6	10 μF	Capacitor, 10 μF, 100 V	TDK	C5750X7S2A106M230KB
C7	220 μF	Capacitor, 220 μF, electrolytic, 100 V	Cornell D.	AFK227M2AR44T-F
R1	10 Ω	Resistor, 10 Ω, 1/8 W	Vishay/Dale	CRCW060310R0FKEA

### Single-Ended Evaluation Board Performance Plots

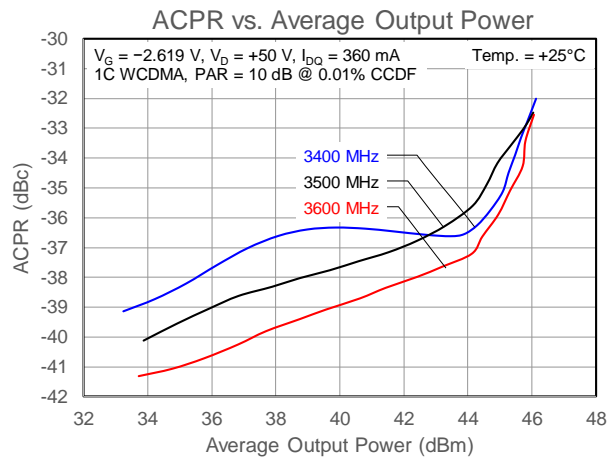
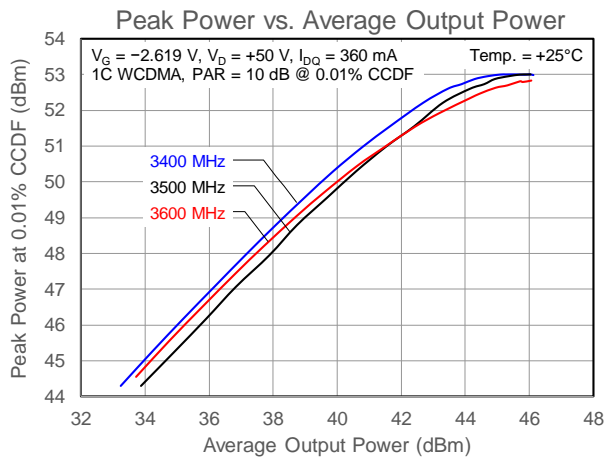
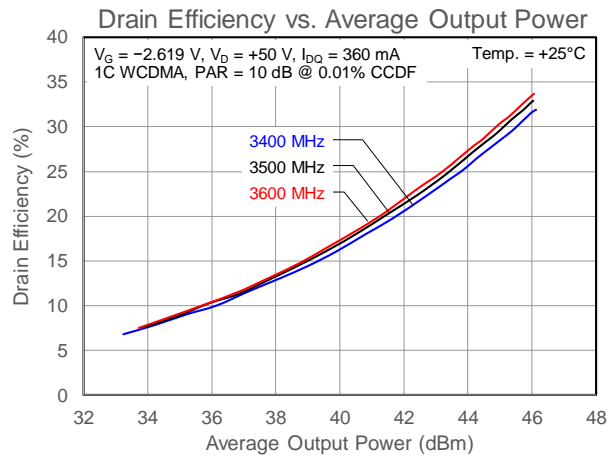
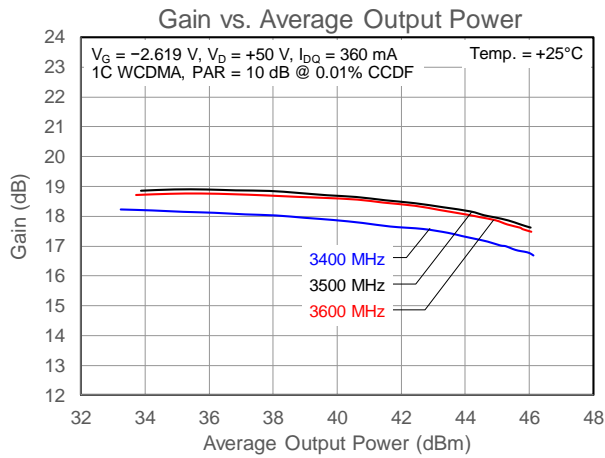
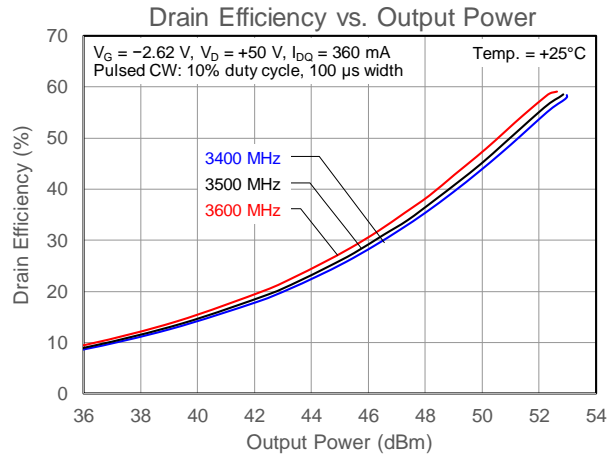
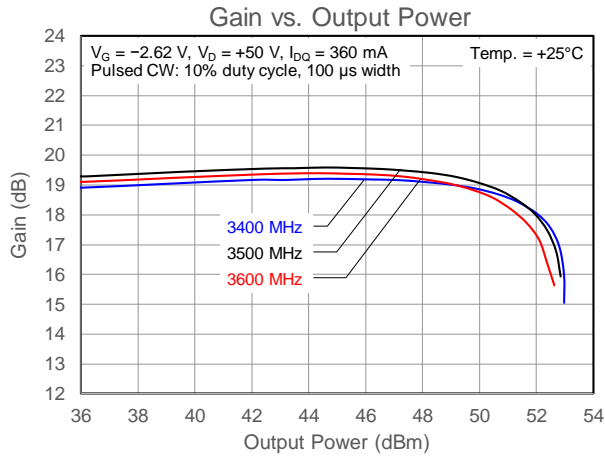

Test conditions unless otherwise noted:  $V_D = +50 \text{ V}$ ,  $I_{DQ} = 360 \text{ mA}$ ,  $T = 25^\circ\text{C}$ , on Class AB single-ended EVB at 3500 MHz

**Single-Ended Evaluation Board Performance Plots**

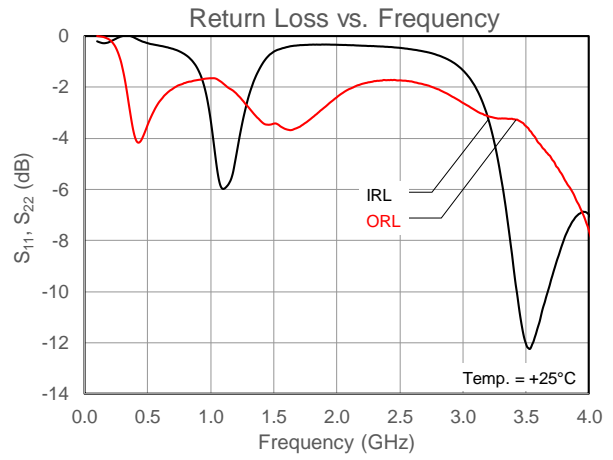
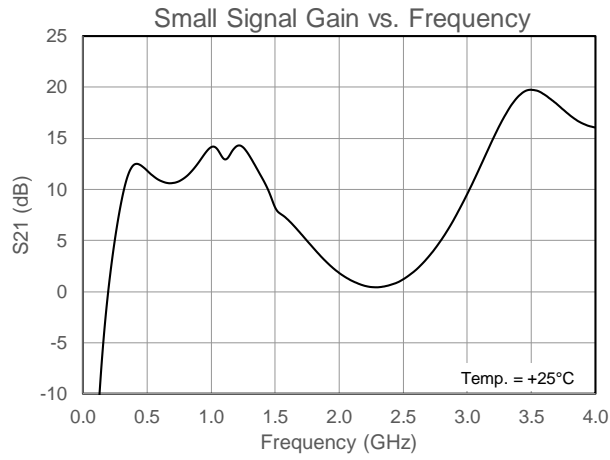

Test conditions unless otherwise noted:  $V_D = +50\text{ V}$ ,  $I_{DQ} = 360\text{ mA}$ ,  $T = 25^\circ\text{C}$ , on Class AB single-ended EVB at 3500 MHz

**RF Characterization – Power-Tuned Load Pull Performance**

Frequency (MHz)	Source Impedance	Load Impedance	Gain @ P3dB (dB)	P3dB (dBm)	Drain Efficiency (%)
3400	11.50 – j15.57	7.76 – j0.96	16.2	53.2	53.3
3500	18.05 – j10.41	6.01 – j0.73	16.6	53.3	55.4
3600	13.17 – j1.70	6.01 – j0.73	16.7	53.4	60.4

Test conditions unless otherwise noted:  $V_D = +50$  V,  $I_{DQ} = 360$  mA,  $T = 25^\circ\text{C}$ , Pulsed 10% duty cycle, 100  $\mu\text{s}$  width)

**RF Characterization – Efficiency-Tuned Load Pull Performance**

Frequency (MHz)	Source Impedance	Load Impedance	Gain @ P3dB (dB)	P3dB (dBm)	Drain Efficiency (%)
3400	11.50 – j15.57	5.38 – j9.66	19.0	50.7	65.9
3500	18.05 – j10.41	6.47 – j6.83	19.2	51.7	67.2
3600	13.17 + j1.70	8.05 – j5.51	18.7	52.0	69.9

Test conditions unless otherwise noted:  $V_D = +50$  V,  $I_{DQ} = 360$  mA,  $T = 25^\circ\text{C}$ , Pulsed 10% duty cycle, 100  $\mu\text{s}$  width)

**Load Pull Plots**

Load Pull at 3.4 GHz

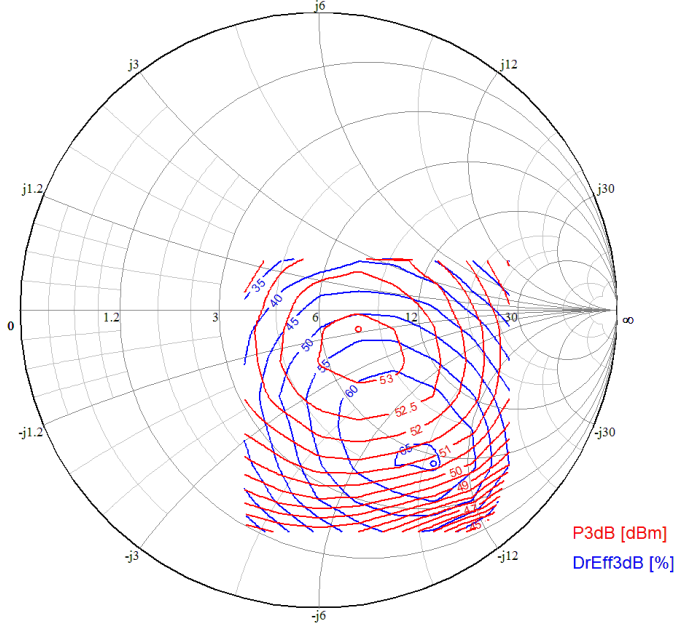

Load Pull at 3.5 GHz

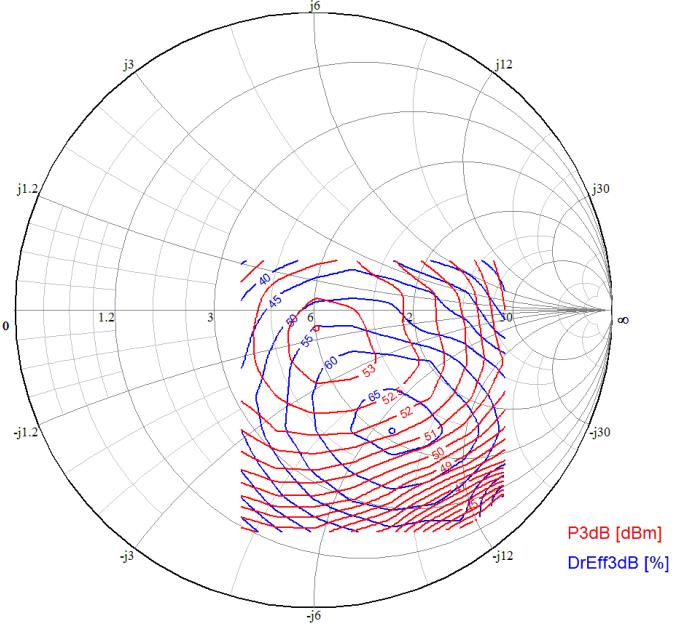

Load Pull at 3.6 GHz

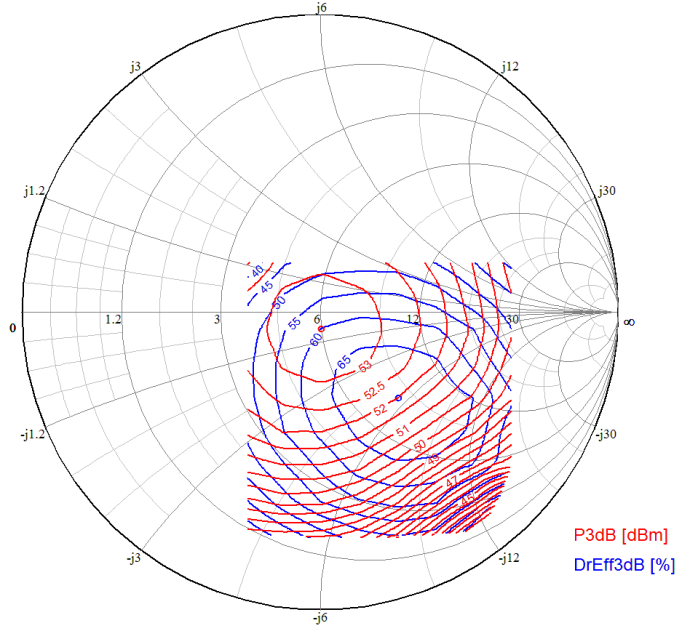

Test conditions unless otherwise noted:  $V_D = +50$  V,  $I_{DQ} = 360$  mA,  $T = 25^\circ\text{C}$ , Pulsed 10% duty cycle, 100  $\mu\text{s}$  width)

### Pin Configuration

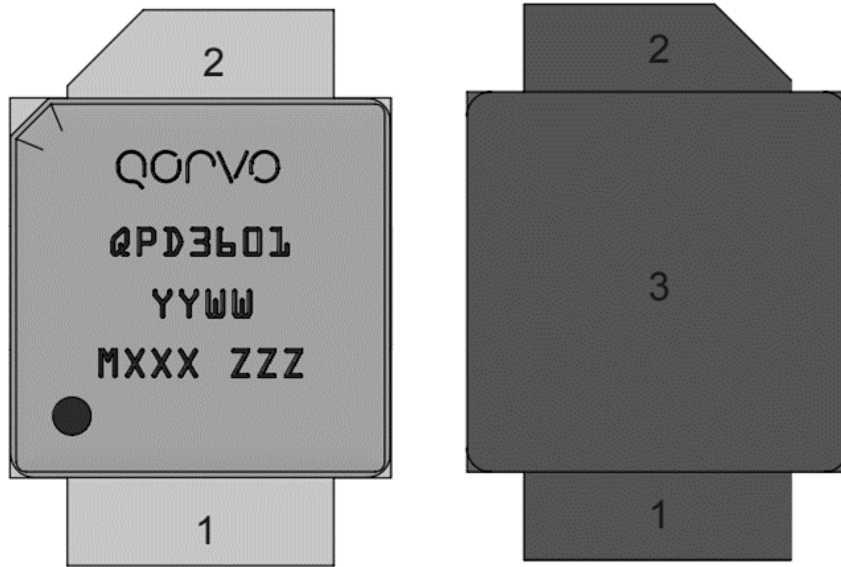

### Pin Description

Pin No.	Label	Description
1	RF IN, $V_G$	RF Input, Gate Bias
2	RF OUT, $V_D$	RF Output, Drain Bias
3 (Backside Paddle)	RF/DC GND	RF/DC Ground



## Package Marking and Dimensions

Marking: Qorvo Logo  
 Part Number – QPD3601  
 Date Code – YYWW  
 Production Lot Number – MXXX  
 Serial Number – ZZZ

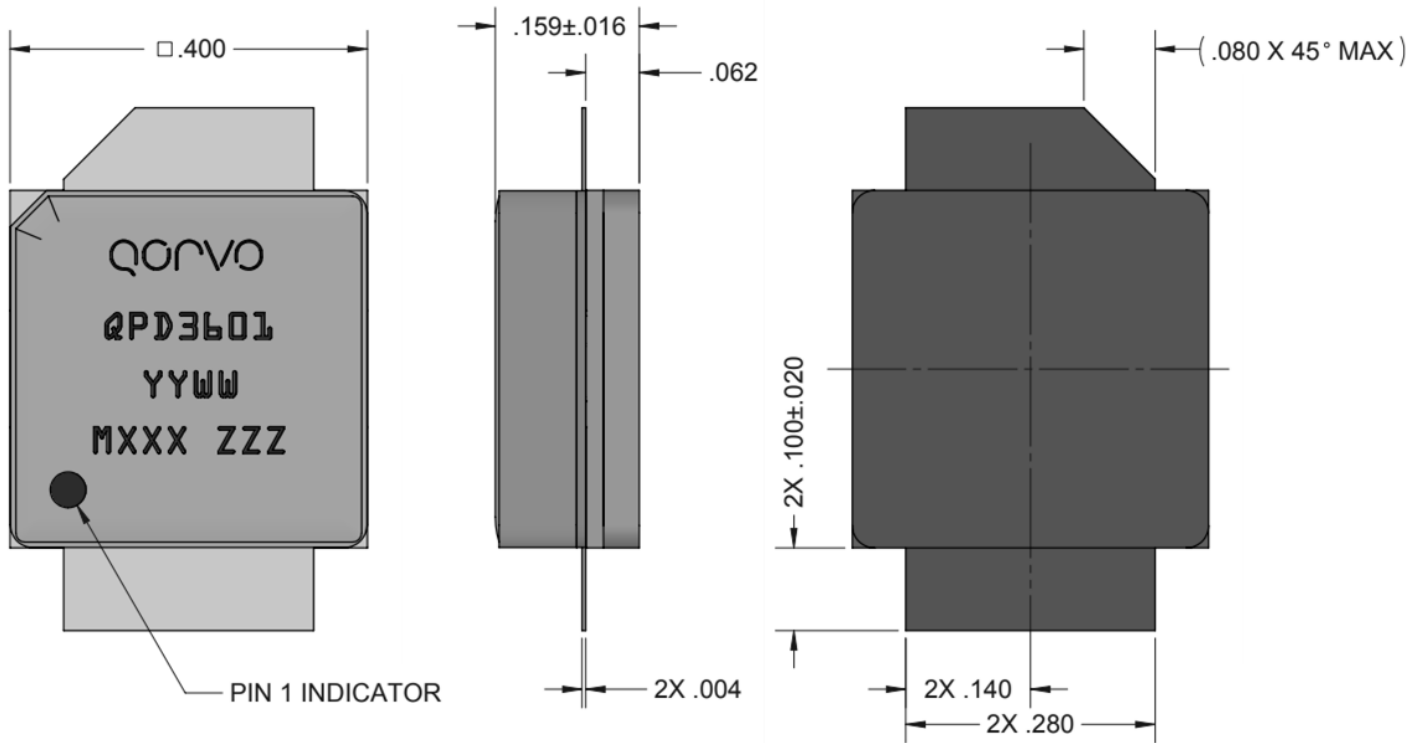

Notes: Unless Otherwise Specified;

1. Material:
  - Package Base: Ceramic/Metal
  - Package Lid: Ceramic
2. Package exposed metallization is NiAu plated. Au thickness is minimum 60  $\mu\text{m}$ .
3. Part is epoxy sealed.
4. Part meets industry NI400 footprint.
5. Body dimensions do not include lid shift or epoxy run out, which can be up to 0.020 per side.
6. Dimensions are in inches. General tolerance is  $\pm 0.005$ .

**Tape and Reel Information – Carrier and Cover Tape Dimensions**

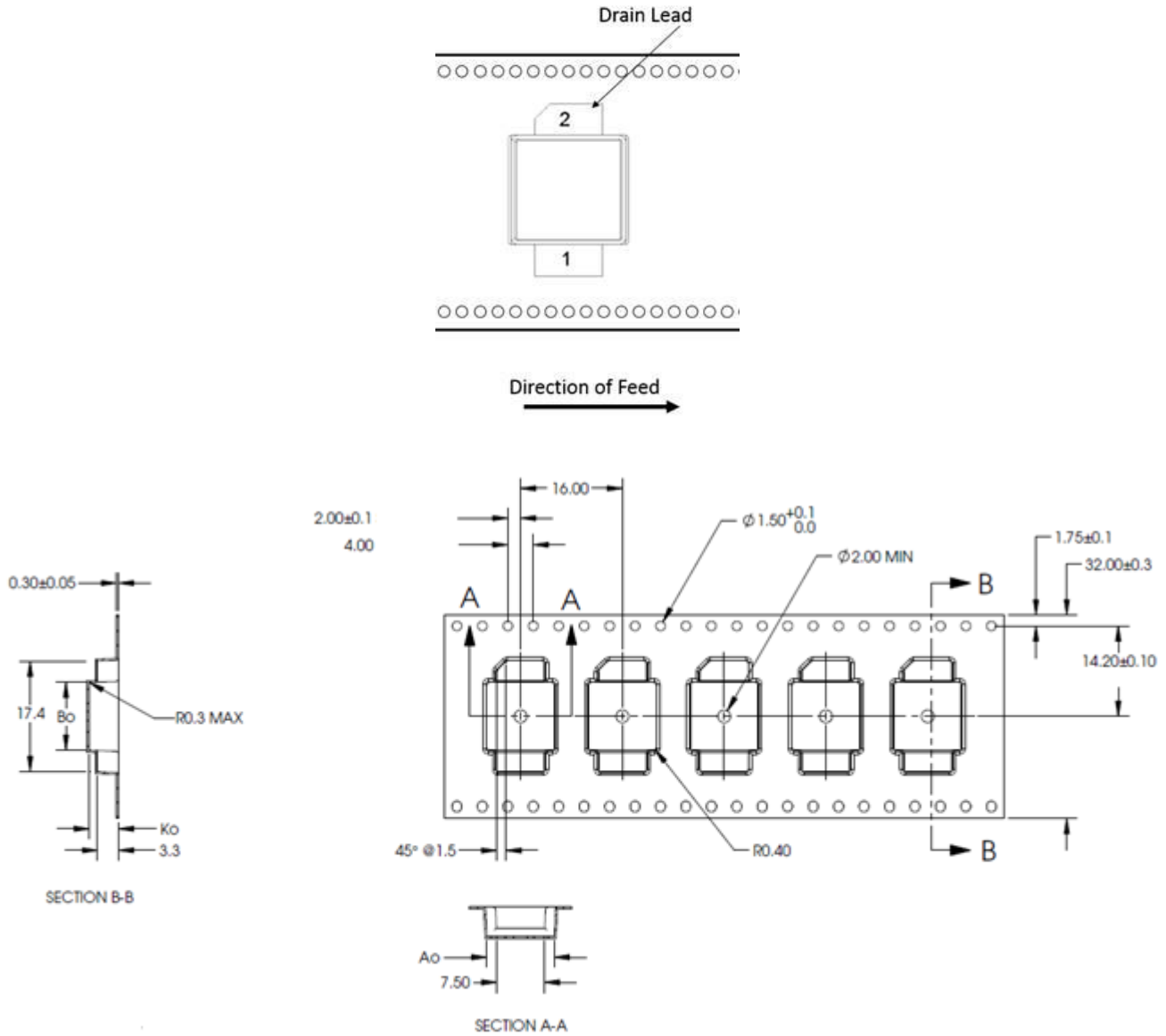

Feature	Measure	Symbol	Size (in)	Size (mm)
Cavity	Length	A0	0.417	10.60
	Width	B0	0.419	10.65
	Depth	K0	0.181	4.60
	Pitch	P1	0.630	16
Centerline Distance	Cavity to Perforation – Length Direction	P2	0.079	2.00
	Cavity to Perforation – Width Direction	F	0.559	14.20
Cover Tape	Width	C	1.004	25.50
Carrier Tape	Width	W	1.260	32

### Tape and Reel Information – Reel Dimensions

Standard T/R size = 250 pieces on a 13" reel.

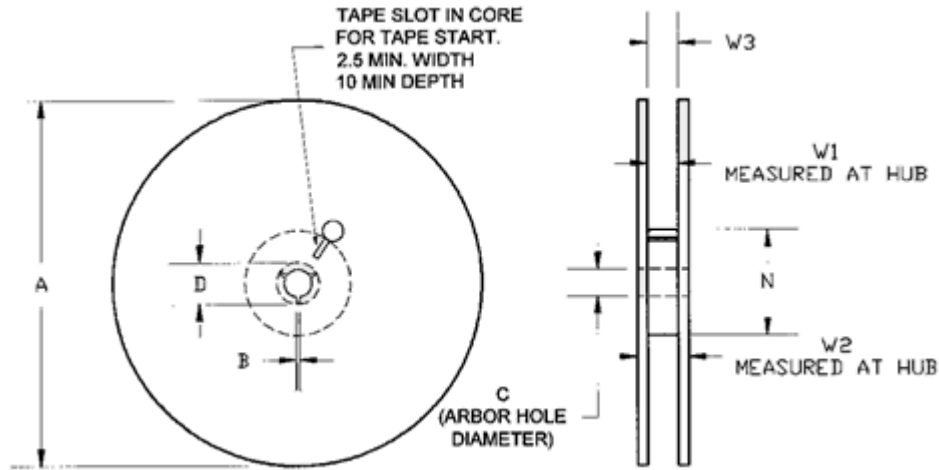

Feature	Measure	Symbol	Size (in)	Size (mm)
Flange	Diameter	A	12.992	330.0
	Thickness	W2	1.504	38.2
	Space Between Flange	W1	1.291	32.8
Hub	Outer Diameter	N	4.016	102.0
	Arbor Hole Diameter	C	0.512	13.0
	Key Slit Width	B	0.079	2.0
	Key Slit Diameter	D	0.787	20.0

### Tape and Reel Information – Tape Length and Label Placement

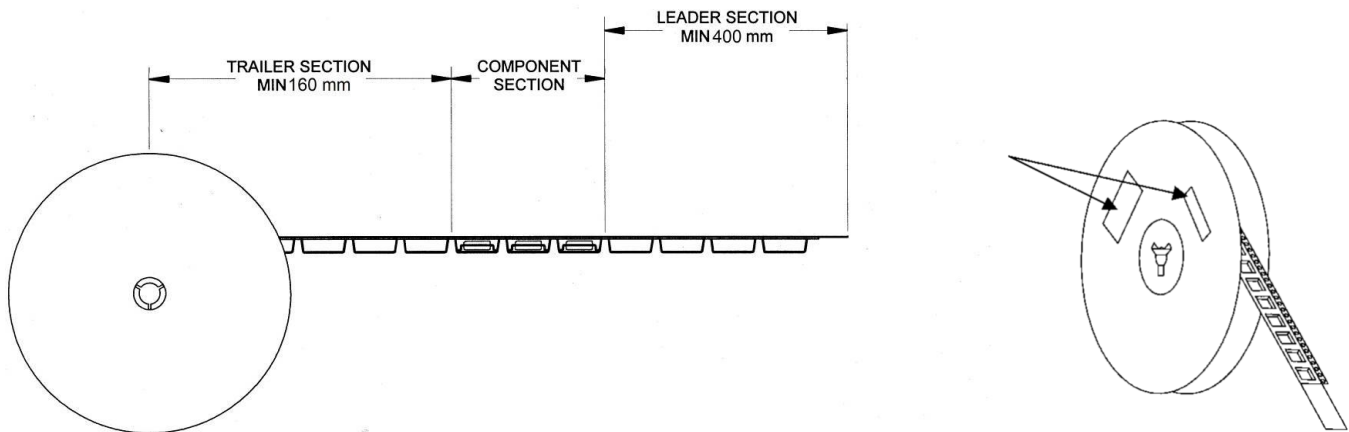

Notes:

1. Empty part cavities at the trailing and leading ends are sealed with cover tape. See EIA 481-1-A.
2. Labels are placed on the flange opposite the sprockets in the carrier tape.

### Handling Precautions

Parameter	Rating	Standard
ESD – Human Body Model (HBM)	Class 1B	ANSI/ESDA/JEDEC Standard JS-
ESD – Charged Device Model (CDM)	Class C3	ANSI/ESDA/JEDEC Standard JS-
MSL – 260°C Convection Reflow	MSL3	IPC/JEDEC Standard J-STD-020



### Solderability

Compatible with both lead-free (260°C maximum reflow temperature) soldering processes. The use of no-clean solder to avoid washing after soldering is recommended. Contact plating is NiAu. Au thickness is minimum 60 µin.

### RoHS Compliance

This product is compliant with the 2011/65/EU RoHS directive (Restrictions on the Use of Certain Hazardous Substances in Electrical and Electronic Equipment), as amended by Directive 2015/863/EU. This product also has the following attributes:

- Product uses RoHS Exemption 7c-II to meet RoHS Compliance requirements.
- Antimony Free
- TBBP-A (C<sub>15</sub>H<sub>12</sub>Br<sub>4</sub>O<sub>2</sub>) Free
- PFOS Free
- SVHC Free

### Contact Information

For the latest specifications, additional product information, worldwide sales and distribution locations, and information about Qorvo:

Web: [www.qorvo.com](http://www.qorvo.com)  
Email: [customer.support@qorvo.com](mailto:customer.support@qorvo.com)

Tel: +1-844-890-8163

For technical questions and application information:

Email: [BTSApplications@qorvo.com](mailto:BTSApplications@qorvo.com)

### Important Notice

The information contained herein is believed to be reliable; however, Qorvo makes no warranties regarding the information contained herein and assumes no responsibility or liability whatsoever for the use of the information contained herein. All information contained herein is subject to change without notice. Customers should obtain and verify the latest relevant information before placing orders for Qorvo products. The information contained herein or any use of such information does not grant, explicitly or implicitly, to any party any patent rights, licenses, or any other intellectual property rights, whether with regard to such information itself or anything described by such information. **THIS INFORMATION DOES NOT CONSTITUTE A WARRANTY WITH RESPECT TO THE PRODUCTS DESCRIBED HEREIN, AND QORVO HEREBY DISCLAIMS ANY AND ALL WARRANTIES WITH RESPECT TO SUCH PRODUCTS WHETHER EXPRESS OR IMPLIED BY LAW, COURSE OF DEALING, COURSE OF PERFORMANCE, USAGE OF TRADE OR OTHERWISE, INCLUDING THE IMPLIED WARRANTIES OF MERCHANTABILITY AND FITNESS FOR A PARTICULAR PURPOSE.**

Without limiting the generality of the foregoing, Qorvo products are not warranted or authorized for use as critical components in medical, life-saving, or life-sustaining applications, or other applications where a failure would reasonably be expected to cause severe personal injury or death.

Copyright 2018 © Qorvo, Inc. | Qorvo is a registered trademark of Qorvo, Inc.

## X-ON Electronics

Largest Supplier of Electrical and Electronic Components

*Click to view similar products for [RF JFET Transistors](#) category:*

*Click to view products by [Qorvo](#) manufacturer:*

Other Similar products are found below :

[CE3514M4](#) [CE3514M4-C2](#) [CE3520K3-C1](#) [CE3521M4](#) [CE3521M4-C2](#) [CE3512K2-C1](#) [CE3520K3](#) [CG2H80030D-GP4](#) [TGF2023-2-02](#)  
[NPT1004D](#) [MAGX-011086](#) [NPT25015D](#) [JANTXV2N4858](#) [MMBFJ211](#) [NPT2021](#) [NPTB00025B](#) [2SK3557-6-TB-E](#) [J211\\_D74Z](#)  
[NPTB00004A](#) [QPD0020](#) [QPD1006](#) [QPD1016](#) [QPD1025L](#) [QPD1029L](#) [QPD1881L](#) [T2G6001528-Q3](#) [SKY65050-372LF](#) [TGF2965-SM](#)  
[QPD1009](#) [QPD1010](#) [J304](#) [CGH27015F](#) [CGH55015F1](#) [CMPA801B030F](#) [GTVA262711FA-V2-R0](#) [GTVA262701FA-V2-R0](#) [CGH40006S](#)  
[CGH40010F](#) [CGH40025F](#) [CGH40045F](#) [CGH40120F](#) [CGH55015F2](#) [CGH60008D](#) [CGH60030D](#) [CGHV14500F](#) [CGHV1F006S](#)  
[CGHV1J006D](#) [CGHV27030S](#) [CGHV27060MP](#) [CGHV40030F](#)