

Product Overview

The QPL7433 is a low noise, high gain, wide bandwidth MMIC pHEMT single ended RF amplifier IC featuring 17.5dB of flat gain. This IC is designed to support CPE Front End, Cable, Satellite and Terrestrial TV, Home Gateways, and Cable Modems from 50 to 3300MHz using a single 5V supply. QPL7433 offers low noise and distortion plus high gain in a 2x2 8pin DFN package.



2X2 DFN 8pin Package

Functional Block Diagram

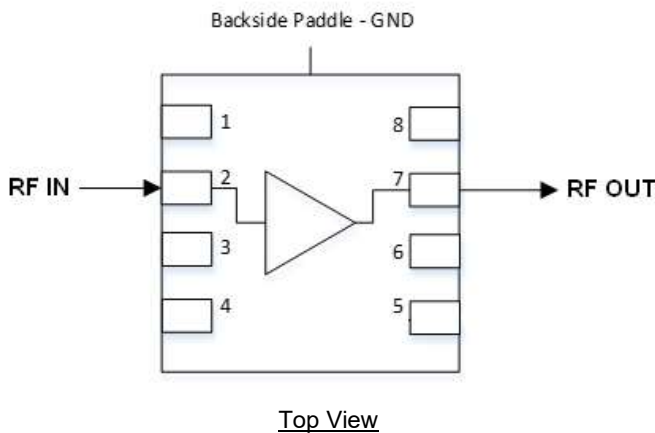

Key Features

- 50 MHz to 3300 MHz Operation
- Low Power Consumption 5 V, 90mA
- Gain: 17.5 dB over the entire BW
- Noise Figure: 1.5 dB Typical
- P1dB: 20dBm
- OIP3: +34dBm
- Adjustable Bias Using External Resistors
- Convenient 2x2, 8pin, DFN Package
- RoHS Compliant

Applications

- Cable, Terrestrial and Satellite
- Extended Spectrum DOCSIS
- CATV Node & Amplifiers
- Optical Node
- Satellite Low Noise Amplifier
- Cable Modem and Set Top Box
- Single Ended Gain Block

Ordering Information

Part Number	Description
QPL7433SB	Sample bag with 5 pieces
QPL7433SR	7" Reel with 100 pieces
QPL7433TR7	7" Reel with 2500 pieces
QPL7433PCK-01	50 – 3300 MHz PCBA



Absolute Maximum Ratings

Parameter	Rating
Supply Voltage (V _{DD})	+10 V
Supply Current (I _{DD})	120 mA
Maximum Input Level	20 dBm
Operating Temperature Range	-40 to +85 °C
Storage Temperature Range	-65 to +150 °C
Maximum Junction Temperature	+150 °C

Exceeding any one or a combination of the Absolute Maximum Rating conditions may cause permanent damage to the device. Extended application of Absolute Maximum Rating conditions to the device may reduce device reliability.

Electrical Specifications – 5 V

Parameter	Condition ⁽¹⁾	Min	Typ	Max	Unit
Supply Voltage (V _{DD})			5		V
Supply Current (I _{DD})			90		mA
Frequency Range		50		3300	MHz
Gain			17.5		dB
Reverse Isolation			20		dB
Input Return Loss			15		dB
Output Return Loss			15		dB
Noise Figure			1.5		dB
OIP2L	5 dBm / tone output, 50-870 MHz		57		dBm
OIP2H	5 dBm / tone output, 1050 MHz		47		dBm
OIP2L	5 dBm / tone output, 2550 MHz		55		dBm
OIP3	5 dBm / tone output, 50-870 MHz		35		dBm
OIP3	5 dBm / tone output, 870-2000 MHz		33		dBm
OIP3	5 dBm / tone output, 2000-3000 MHz		29		dBm
OP1dB	50-2000 MHz		19.5		dBm
OP1dB	2000-3000 MHz		18.5		dBm
Thermal Resistance	Θ _{JC}		62		°C/W

Notes:

1. Typical performance at these conditions: Temp = +25 °C, V_{DD} = +5V, 50 Ω system, Full band unless otherwise noted

Evaluation Board Schematic 50 MHz – 3300 MHz

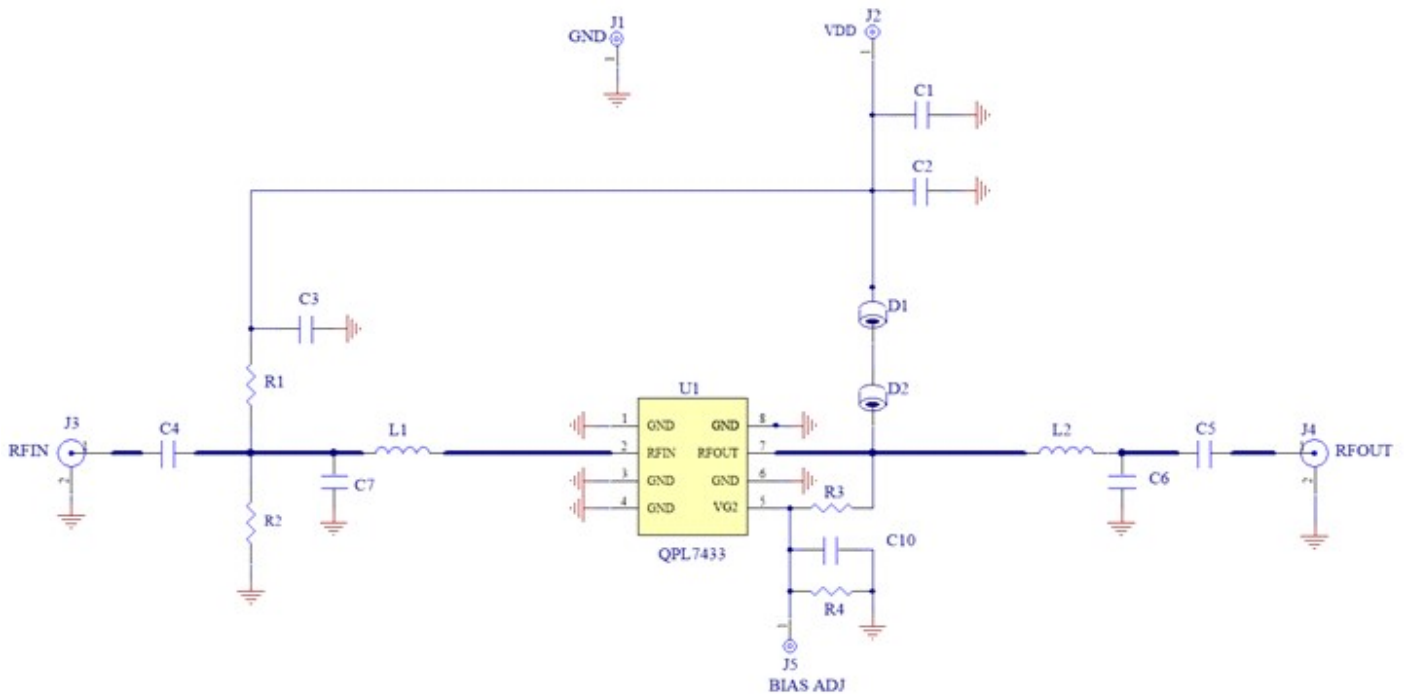

Notes:

1. L1, C7 tunes input return loss.
2. L2, C6 tune output return loss.
3. D1, D2 provide the bias path with RF isolation from the RF output path.
4. C4, C5 provide DC block.
5. R1, R2 and C3 are options that may be added from the input to VDD or to ground to increase linearity or shed power, trading off degraded noise figure and return loss. Device current can only be adjusted strictly through R1 and R2.
6. Pin5 is an internal gate voltage adjust and can be left floating at VDD=5V.

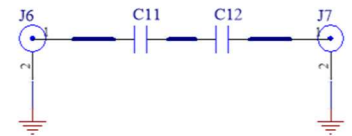

Typical Application Schematic, 50 MHz – 3300 MHz

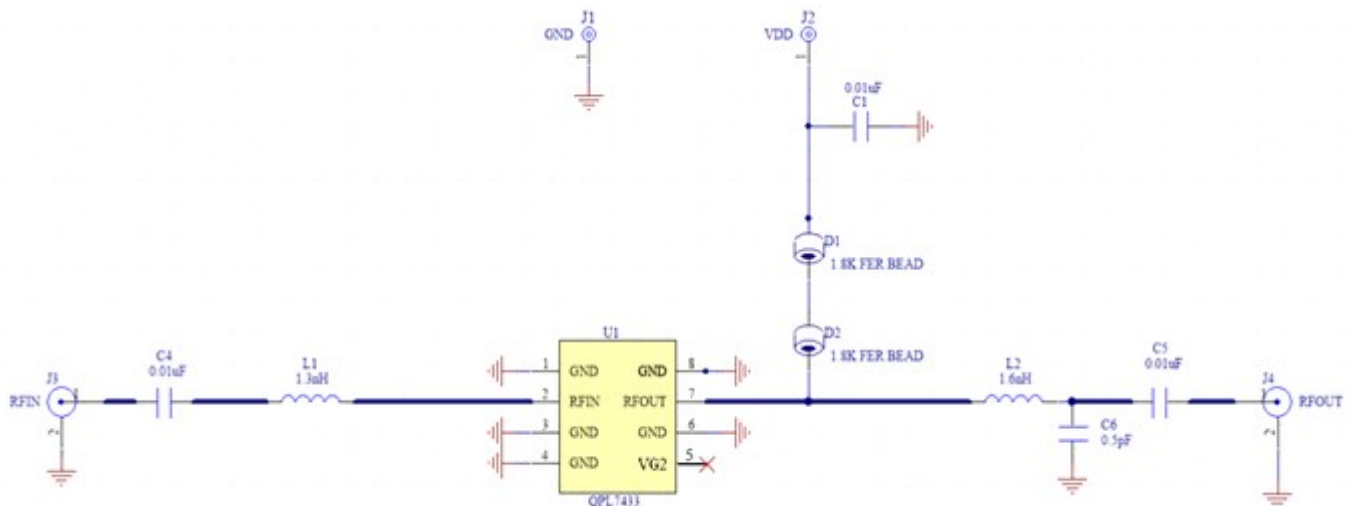

Evaluation Board Bill of Materials

Designator	Description	Manufacturer	Part Number
PCB	QPL7433-4000 EVB	TTM Technology INC	QPL7433-4000(A)
U1	QPL7433	Qorvo	QPL7433SB
D1, D2	FER, BEAD, 1.8K, 5%, 200mA, 0402	TDK	MMZ1005A182ET000
C6	CAP, 0.5pF, +/-0.1pF, 50V, 0402	Murata Electronics	GJM1555C1HR50BB01D
C1, C4, C5, C10	CAP, 0.01uF, 10%, 50V, X8L, 0402	Murata Electronics	GCM155L81E103KA37D
L1	IND, 1.3nH, +/-0.1nH, 0402	Murata Electronics	LQG15HS1N3B02
L2	IND, 1.6nH, +/-0.1nH, 0402	Murata Electronics	LQG15HS1N6B02
J3, J4, J6, J7	862000-422 CONN, SMA F, 50 Ohm	Cinch Connectivity Solutions	142-0701-851
J1, J2, J5	862000-055 TERM. SOLDER TURRET	Mouser Electronics, Inc	2533-0-00-44-00-00-07-0
C2, C3, C7, C11, C12, R1, R2, R3, R4	Not Populated		

Evaluation Board Assembly Drawing

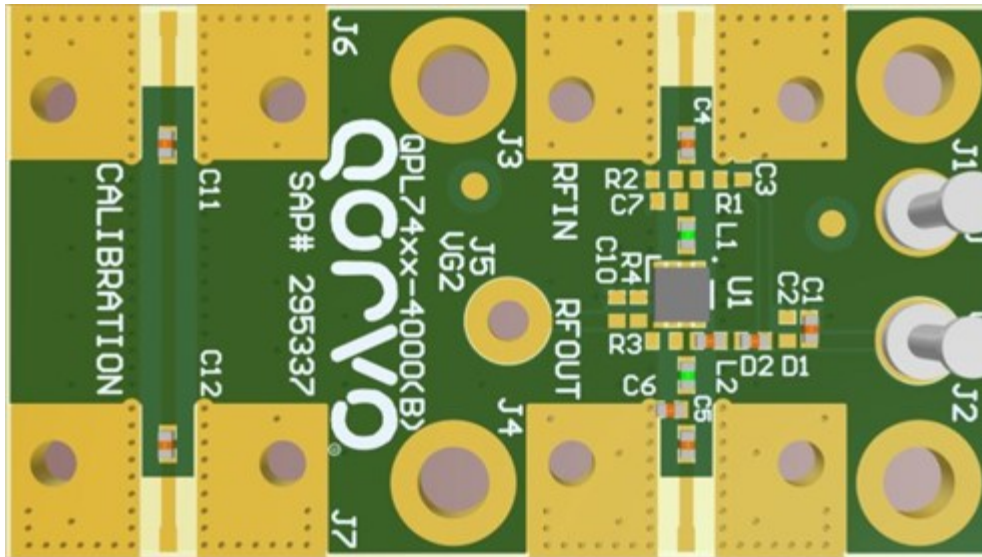

EVB PCB Material and Stack-up

Board Material: Rogers 4350B, 4450F, 62mil total thickness.

$\epsilon_r = 3.66$

Plating: 1.0 oz Copper

Board Dimension: 0.810" x 1.450"

Layer	Name	Material	Thickness	Constant
1	Top Overlay			
2	Top Solder	Solder Resist	0.40mil	3.5
3	Top Layer	Copper	1.40mil	
4	Dielectric1	Rogers 4350B	10.00mil	3.66
5	Signal Layer 1	Copper	1.40mil	
6	Dielectric 3	Rogers 4450F	42.00mil	3.52
7	Signal Layer 2	Copper	1.40mil	
8	Dielectric 2	Rogers 4350B	10.00mil	3.66
9	Bottom Layer	Copper	1.40mil	
10	Bottom Solder	Solder Resist	0.40mil	3.5
11	Bottom Overlay			

Total Thickness: 62 mil +/-10%

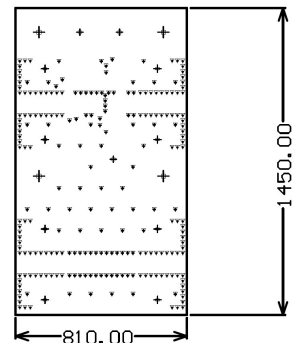

Performance Data at 5 V

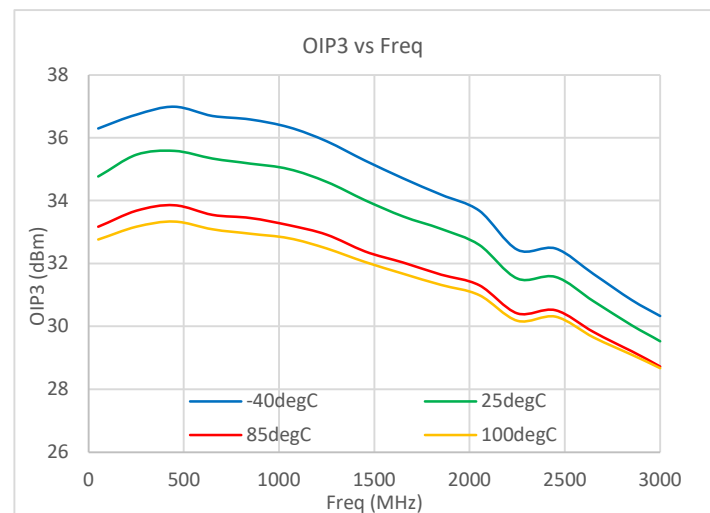
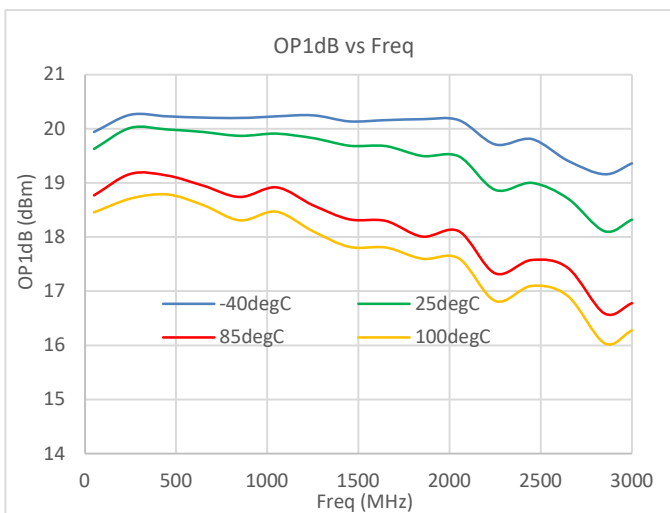
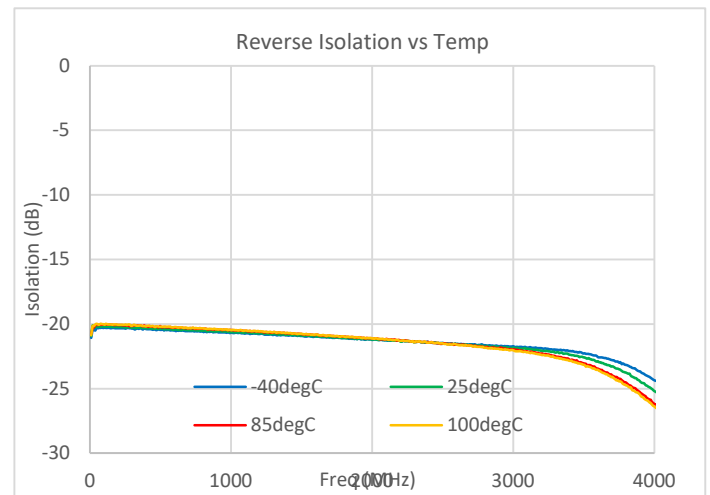
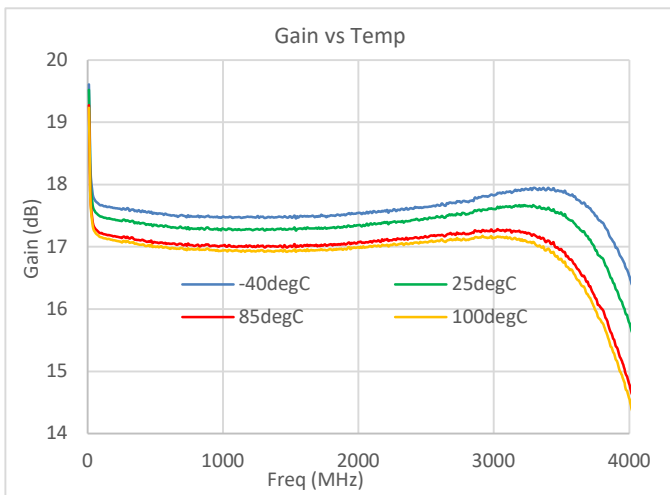
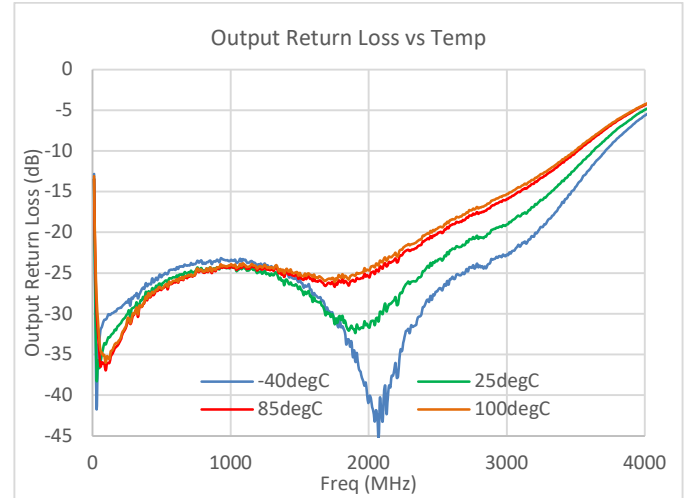
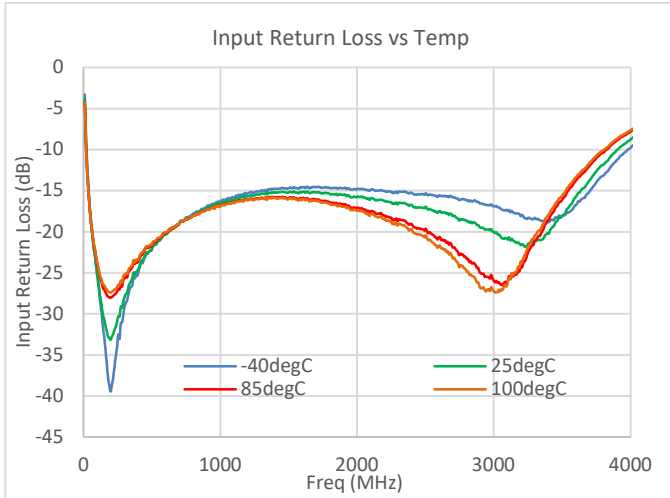

Performance Data at 5 V (cont'd)

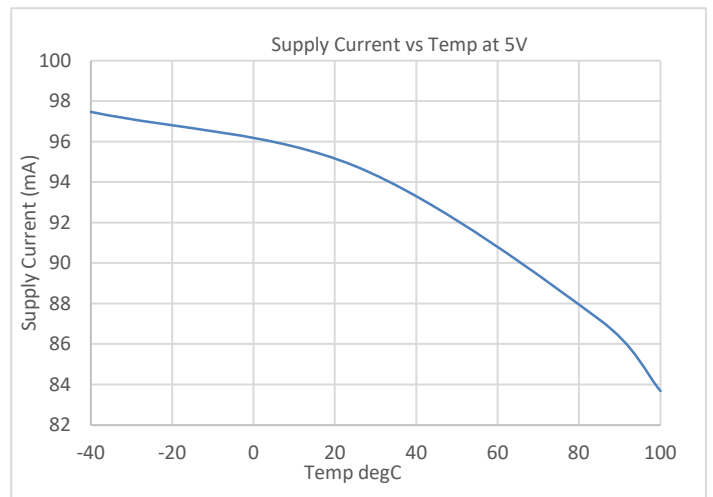
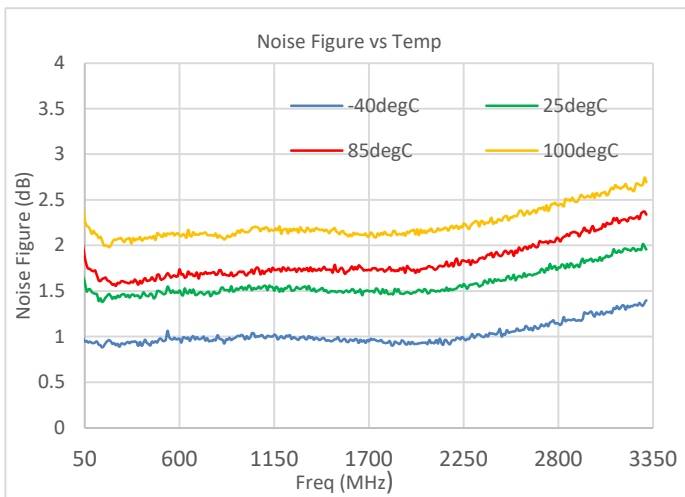
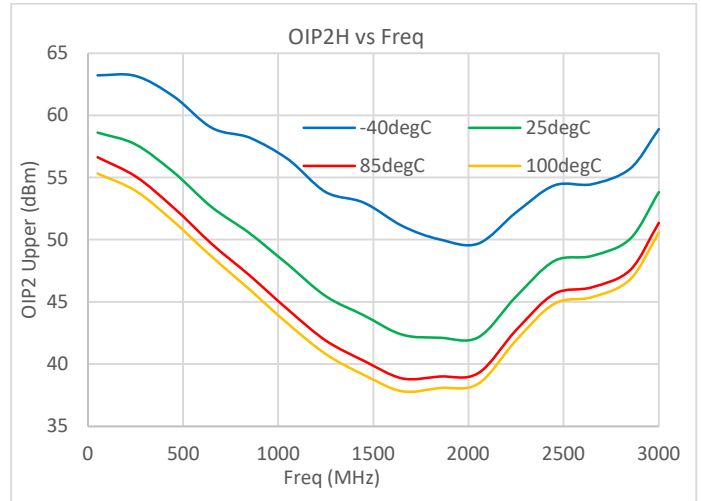
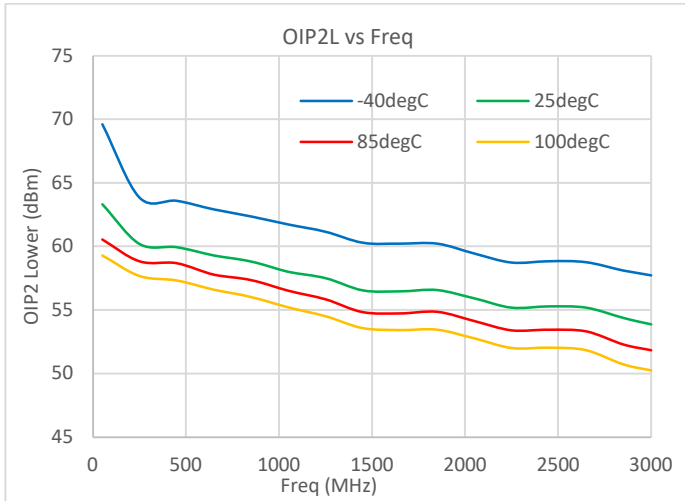

Notes:

1. $V_{DD} = +5V$, 50 Ω system
2. OIP3: +5 dBm / tone output, 5MHz spacing
3. OIP2: 5 dBm / tone output, 53MHz spacing

Additional Applications – Bias Resistor Options

Pullup or pulldown resistors may be used to change the bias current (IDD) for a given bias voltage (VDD). Refer to the EVB schematic on Page 3. IDD must not exceed 120mA and the junction temperature can not exceed 150 °C at the maximum ambient operating temperature. Note that for some cases, return loss may need to be reoptimized by adjusting L1, L2, C7 and C6.

IDD (mA)	4V		5V		6V		7V		8V	
	R1	R2	R1	R2	R1	R2	R1	R2	R1	R2
100	121.0K	DNP	390.0K	DNP	DNP	100K	DNP	36.5K	DNP	24.3K
90	220.0K	DNP	DNP	DNP	DNP	47.0K	DNP	24.3K	DNP	16.9K
80	590.0K	DNP	DNP	60.4K	DNP	28.0K	DNP	18.2K	DNP	13.7K
70	DNP	220.0K	DNP	40.2K	DNP	22.0K	DNP	15.0K	DNP	11.0K
60	DNP	68.0K	DNP	28.0K	DNP	16.2K	DNP	12.0K	DNP	9.90K
45	DNP	27.4K	DNP	16.9K	DNP	11.0K	DNP	8.66K	DNP	6.98K

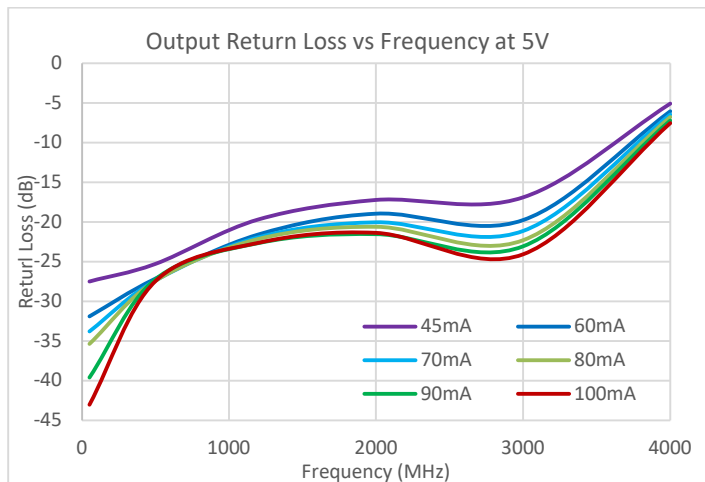
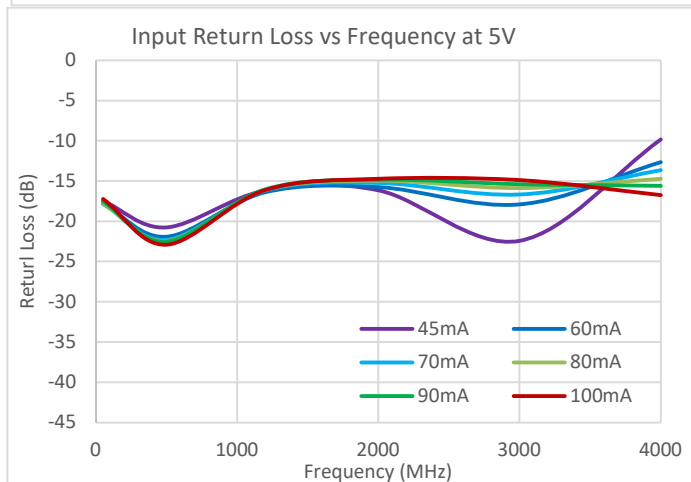
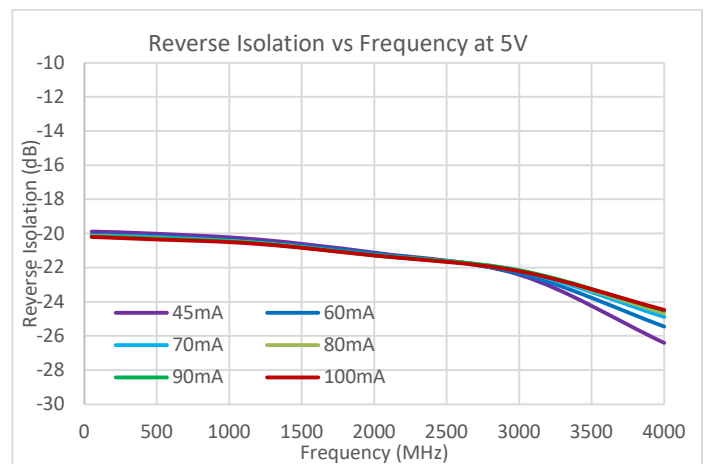
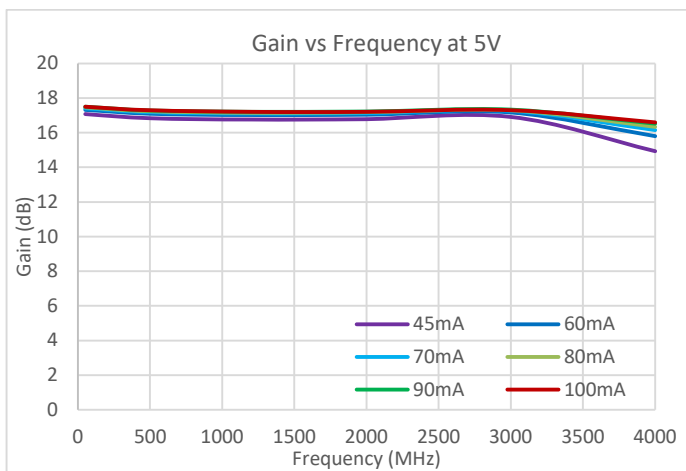

Notes:
 (1) V_{DD} = +5V, 50 Ω system

Additional Applications, cont'd – Bias Resistor Options

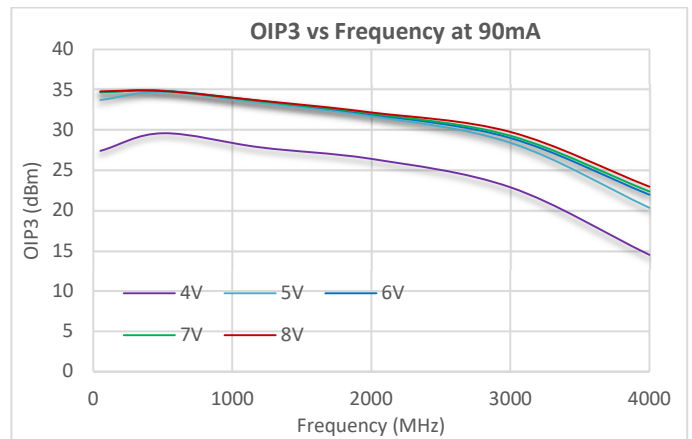
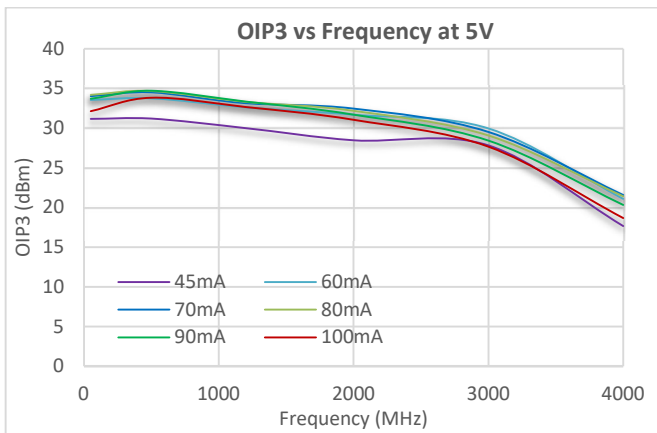
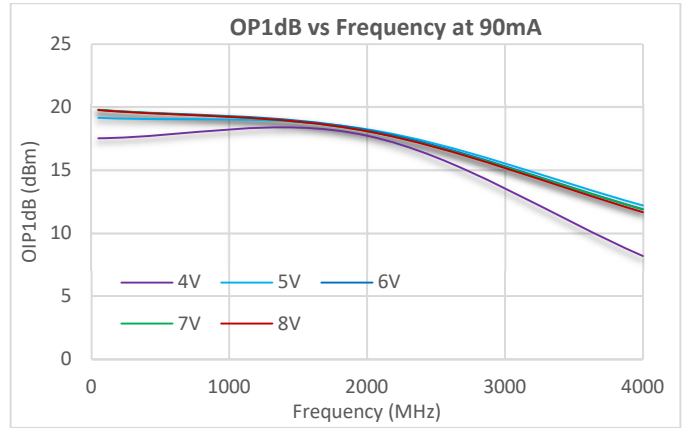
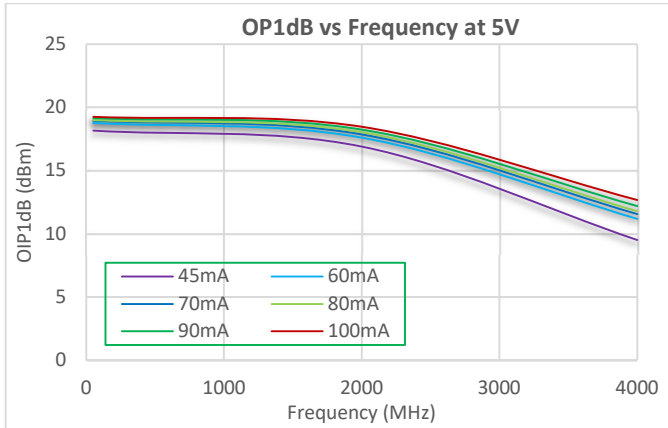

Notes:

- (1) $V_{DD} = +5V$, 50 Ω system
- (2) OIP3: +5 dBm / tone output, 5MHz spacing

Additional Applications, cont'd – Bias Resistor Options

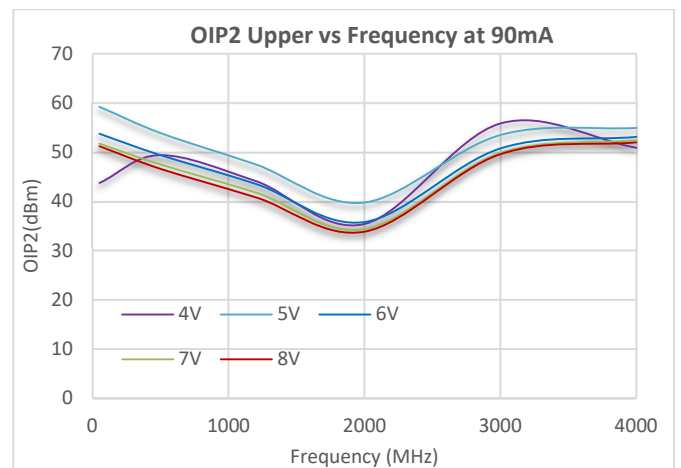
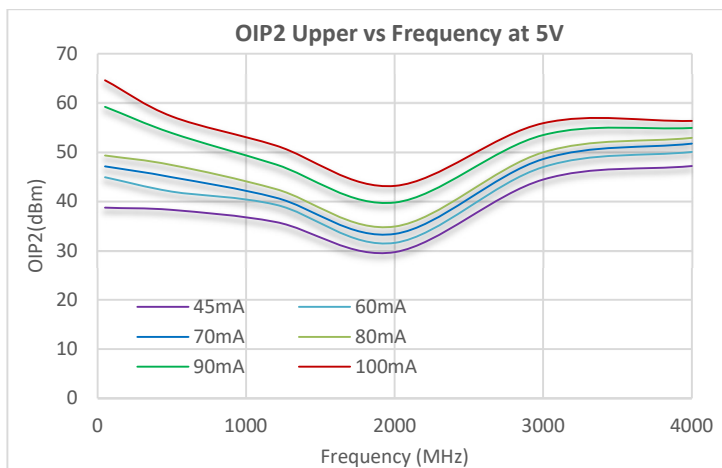
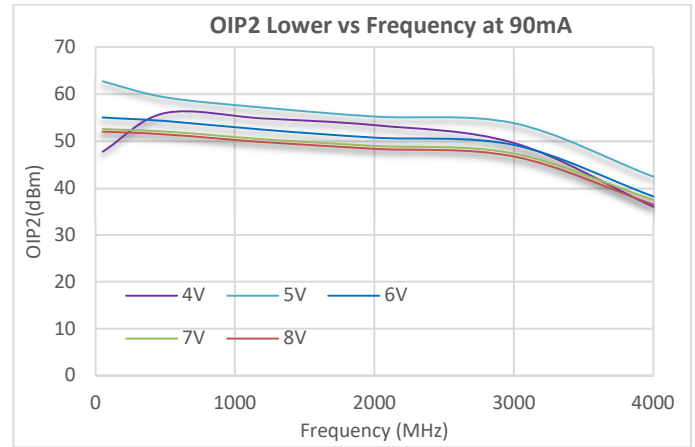
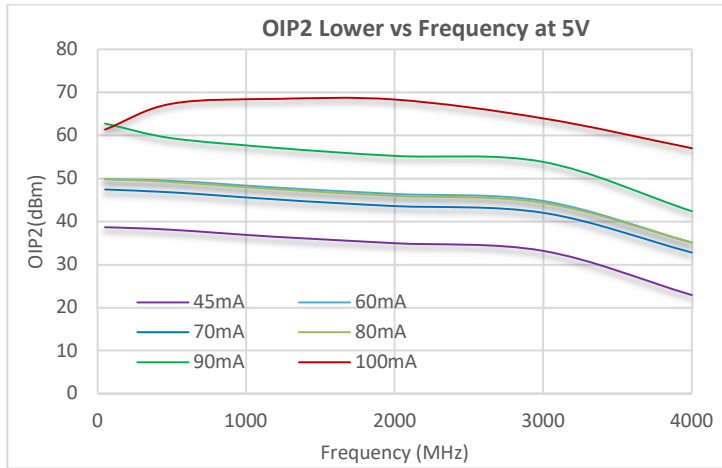

Notes:

- (1) $V_{DD} = +5V$, 50 Ω system
- (2) OIP2: +5 dBm / tone output, 53MHz spacing

Pin Configuration and Description

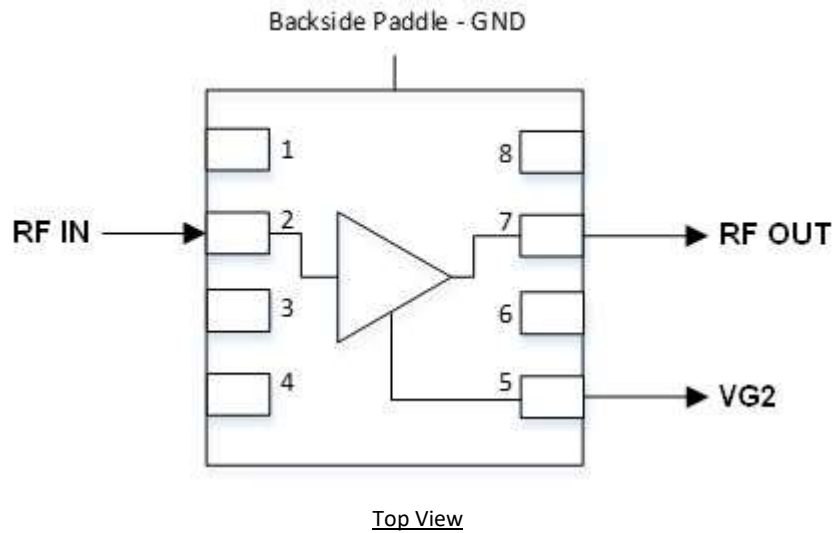

Pin Number	Label	Description
2	RF IN	RF Input, DC blocking capacitor required
1,3,4,6,8	GND	Internally Not Connected
7	RF OUT / VDD	RF Output – VDD bias Ferrite Bead required
5	VG2	Gate Voltage adjust. Leave as no connect.
Backside Paddle	GND	Ground. Use recommended via pattern to minimize inductance and thermal resistance. See PCB Mounting Pattern for suggested footprint.

Package Marking Dimensions

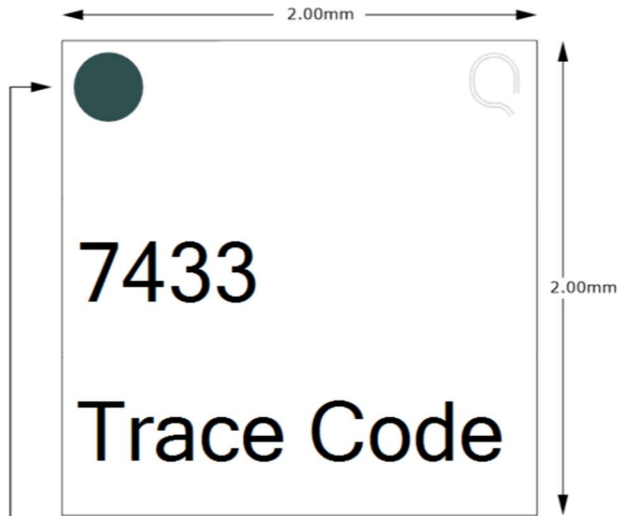

Pin 1 Indicator

Qorvo Logo - Use Q5D

Trace Code to be assigned by SubCon

Package Outline

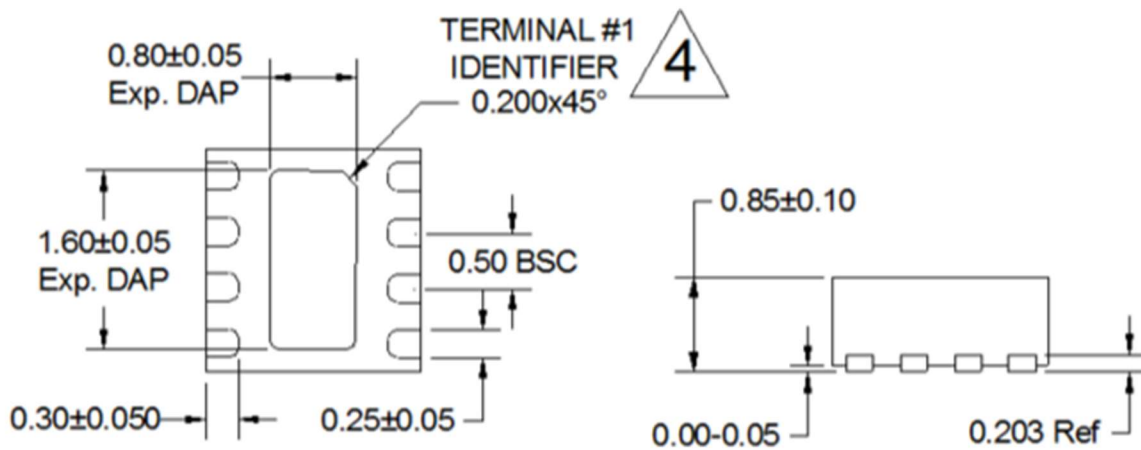

Notes:

1. All dimensions in millimeters. Angles are in degrees.
2. Except where noted, this part outline conforms to JEDEC standard MO-220, Isse E (Variation VGGC) for thermally enhanced Plastic very thin fine pitch dual flat no lead package (DFN)
3. Dimension and tolerance formats conform to ASME Y14.4M-1994.
4. The terminal #1 identifier and terminal numbering conforms to JESD 95-1 SPP-012.

Recommended Mounting Pattern

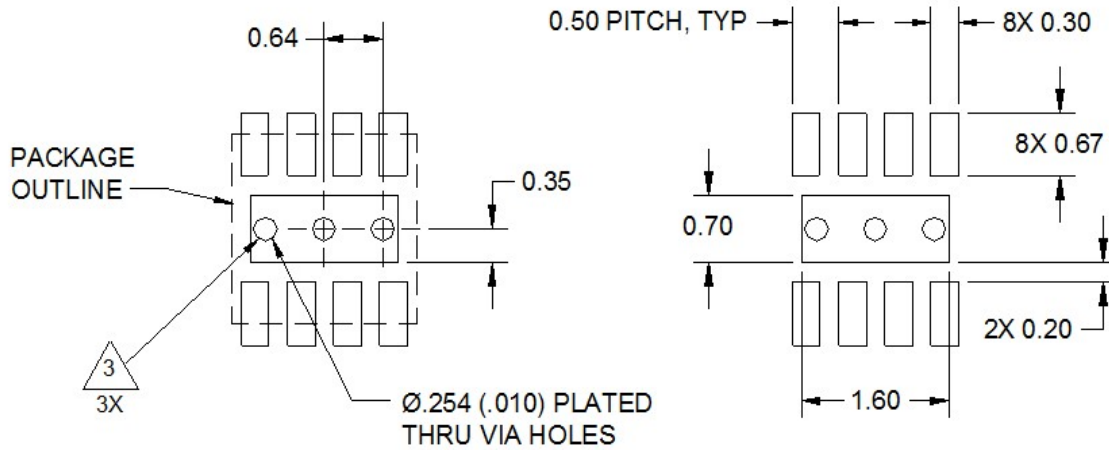

Notes:

1. All dimensions are in millimeters (inches). Angles are in degrees.
2. Use 1 oz copper minimum for top and bottom layer.
3. Via holes are required under the backside paddle of this device for proper RF/DC grounding and thermal dissipation. We recommend a 0.35mm diameter bit for drilling via holes and a final plated thru diameter of 0.25mm.
4. All dimensions are in millimeters (inches). Angles are in degrees.

Handling Precautions

Parameter	Rating	Standard
ESD – Human Body Model (HBM)	1B (500V)	ANSI / ESDA / JEDEC JS-001
ESD – Charged Device Model (CDM)	C3 (1000V)	ANSI / ESDA / JEDEC JS-002
MSL – Moisture Sensitivity Level	MSL3	IPC / JEDEC J-STD-020



Caution!
ESD-Sensitive Device

Solderability

Compatible with both lead-free (260 °C max. reflow temp.) and tin/lead (245 °C max. reflow temp.) soldering processes. Solder profiles available upon request.

Contact plating: NiPdAu

RoHS Compliance

This part is compliant with 2011/65/EU RoHS directive (Restrictions on the Use of Certain Hazardous Substances in Electrical and Electronic Equipment) as amended by Directive 2015/863/EU.

This product also has the following attributes:

- Lead Free
- Halogen Free (Chlorine, Bromine)
- Antimony Free
- TBBP-A (C₁₅H₁₂Br₄O₂) Free
- SVHC Free



Contact Information

For the latest specifications, additional product information, worldwide sales and distribution locations:

Tel: 1-844-890-8163

Web: www.qorvo.com

Email: customer.support@qorvo.com

Important Notice

The information contained herein is believed to be reliable; however, Qorvo makes no warranties regarding the information contained herein and assumes no responsibility or liability whatsoever for the use of the information contained herein. All information contained herein is subject to change without notice. Customers should obtain and verify the latest relevant information before placing orders for Qorvo products. The information contained herein or any use of such information does not grant, explicitly or implicitly, to any party any patent rights, licenses, or any other intellectual property rights, whether with regard to such information itself or anything described by such information. **THIS INFORMATION DOES NOT CONSTITUTE A WARRANTY WITH RESPECT TO THE PRODUCTS DESCRIBED HEREIN, AND QORVO HEREBY DISCLAIMS ANY AND ALL WARRANTIES WITH RESPECT TO SUCH PRODUCTS WHETHER EXPRESS OR IMPLIED BY LAW, COURSE OF DEALING, COURSE OF PERFORMANCE, USAGE OF TRADE OR OTHERWISE, INCLUDING THE IMPLIED WARRANTIES OF MERCHANTABILITY AND FITNESS FOR A PARTICULAR PURPOSE.**

Without limiting the generality of the foregoing, Qorvo products are not warranted or authorized for use as critical components in medical, life-saving, or life-sustaining applications, or other applications where a failure would reasonably be expected to cause severe personal injury or death.

Copyright 2020 © Qorvo, Inc. | Qorvo is a registered trademark of Qorvo, Inc.

X-ON Electronics

Largest Supplier of Electrical and Electronic Components

Click to view similar products for [RF Amplifier](#) category:

Click to view products by [Qorvo](#) manufacturer:

Other Similar products are found below :

[A82-1](#) [BGA622H6820XTSA1](#) [BGA 728L7 E6327](#) [BGB719N7ESDE6327XTMA1](#) [HMC397-SX](#) [HMC405](#) [HMC561-SX](#) [HMC8120-SX](#)
[HMC8121-SX](#) [HMC-ALH382-SX](#) [HMC-ALH476-SX](#) [SE2433T-R](#) [SMA3101-TL-E](#) [SMA39](#) [A66-1](#) [A66-3](#) [A67-1](#) [LX5535LQ](#) [LX5540LL](#)
[MAAM02350](#) [HMC3653LP3BETR](#) [HMC549MS8GETR](#) [HMC-ALH435-SX](#) [SMA101](#) [SMA32](#) [SMA411](#) [SMA531](#) [SST12LP19E-QX6E](#)
[WPM0510A](#) [HMC5929LS6TR](#) [HMC5879LS7TR](#) [HMC1126](#) [HMC1087F10](#) [HMC1086](#) [HMC1016](#) [SMA1212](#) [MAX2689EWS+T](#)
[MAAMSS0041TR](#) [MAAM37000-A1G](#) [LTC6430AIUF-15#PBF](#) [SMA70-2](#) [SMA4011](#) [A231](#) [HMC-AUH232](#) [LX5511LQ](#) [LX5511LQ-TR](#)
[HMC7441-SX](#) [HMC-ALH310](#) [XD1001-BD-000V](#) [A4011](#)