

Product Overview

Qorvo’s QPM2239 is a packaged, high-power Ku-band amplifier module, fabricated on Qorvo’s production 0.25 um GaN on SiC process (QGaN25). Covering 13– 15.5 GHz, the QPM2239 provides 80 W of saturated output power and 29 dB of small-signal gain while achieving > 25% power-added efficiency.

The QPM2239 is packaged in a 10-lead 19.05 x 19.05 mm bolt-down package with a Cu base for superior thermal management. It can support a variety of operating conditions to best support system requirements. With good thermal properties, it can support a range of bias voltages and will perform well under CW operation.

The QPM2239 has DC blocking capacitors on both RF ports, which are matched to 50 ohms.

The QPM2239 is ideal for supporting communications and radar applications in both commercial and military markets

RoHS compliant

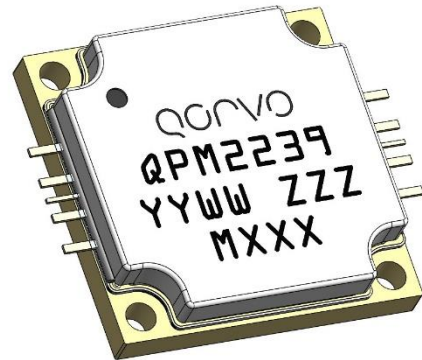

Key Features

- Frequency Range: 13 – 15.5 GHz
- P_{SAT} ($P_{IN} = 25$ dBm): 49 dBm
- PAE ($P_{IN} = 25$ dBm): > 25 %
- IM3 ($P_{OUT}/Tone = 38$ dBm): -22 dBc
- Small Signal Gain: 29 dB
- Bias: CW, $V_D = +28$ V, $I_{DQ} = 800$ mA, $V_G = -2.5$ V typ.
- Package Dimensions: 19.05 x 19.05 x 4.5 mm

Performance is typical across frequency. Please reference electrical specification table and data plots for more details.

Functional Block Diagram

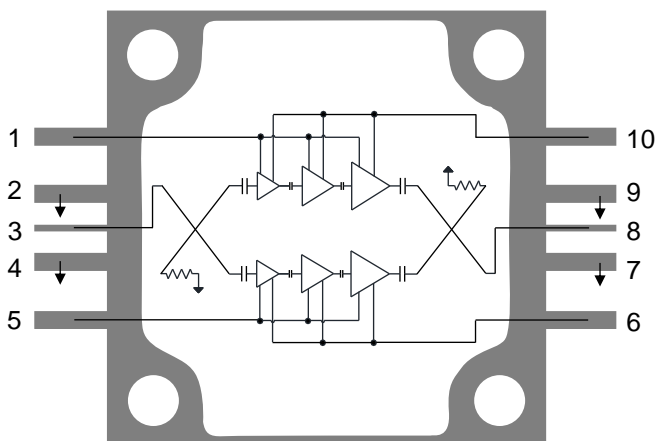

Applications

- Commercial VSAT
- Military Satcom
- Datalinks
- Radar

Ordering Information

Part No.	Description
QPM2239	13-15.5GHz 80W GaN Power Amplifier Module
QPM2239S2	Samples (2 pcs. pack)
QPM2239EVB1	Evaluation Board for QPM2239

Absolute Maximum Ratings

Parameter	Value / Range
Drain Voltage (V_D)	+29.5 V
Gate Voltage Range (V_G)	-6 to 0 V
Drain Current (I_D)	12.5 A
Gate Current (I_G)	See chart page 13
Power Dissipation (P_{DISS}), 85 °C	234 W
Input Power (P_{IN}), CW, 50 Ω , $V_D=28$ V, $I_{DQ}=800$ mA, $T_{BASE} = 85$ °C	28 dBm
Input Power (P_{IN}), CW, 3:1 VSWR, $V_D=28$ V, $I_{DQ}=800$ mA, $T_{BASE} = 85$ °C	27 dBm
Soldering Temperature (30 seconds)	260 °C
Storage Temperature	-55 to +150 °C

Operation of this device outside the parameter ranges given above may cause permanent damage. These are stress ratings only, and functional operation of the device at these conditions is not implied.

Recommended Operating Conditions

Parameter	Min	Typ	Max	Units
Drain Voltage (V_D)		+28		V
Drain Current, Quiescent (I_{DQ})		800	900	mA
Drain Current, RF (I_{D_Drive})	See chart page 3, 4, 6			mA
Gate Voltage Typ. Range (V_G)	-2 to -2.9			V
Gate Current, RF (I_{G_Drive})	See chart page 6			mA
T_{BASE} Range	-40		+85	°C

Electrical specifications are measured at specified test conditions. Specifications are not guaranteed over all recommended operating conditions.

Electrical Specifications

Parameter	Conditions ⁽¹⁾ ⁽²⁾	Min	Typ	Max	Units
Operational Frequency Range		13		15.5	GHz
Output Power at Saturation, P_{SAT}	$P_{IN} = +25$ dBm		49		dBm
Power Added Efficiency, PAE	$P_{IN} = +25$ dBm		25		%
3 RD Intermodulation Products, IM3	$P_{OUT}/Tone = +38$ dBm; $\Delta f = 10$ MHz		-22		dBc
5 TH Intermodulation Products, IM5	$P_{OUT}/Tone = +38$ dBm; $\Delta f = 10$ MHz		-30		dBc
Small Signal Gain, S_{21}			29		dB
Input Return Loss, IRL			15		dB
Output Return Loss, ORL			15		dB
P_{SAT} Temperature Coefficient	$T_{DIFF} = -40$ °C to +85°C ; $P_{IN} = +25$ dBm		-0.01		dBm/°C
S_{21} Temperature Coefficient	$T_{DIFF} = -40$ °C to +85°C		-0.11		dB/°C

Notes:

1. Test conditions unless otherwise noted: CW, $V_D = 28$ V, $I_{DQ} = 800$ mA, $V_G = -2.5$ V +/- typical , $T_{BASE} = +25$ °C, $Z_0 = 50$ Ω
2. T_{BASE} is back side of package

Performance Plots – Large Signal

Test conditions unless otherwise noted: CW, $V_D = 28\text{ V}$, $I_{DQ} = 800\text{ mA}$, $T_{BASE} = +25\text{ °C}$

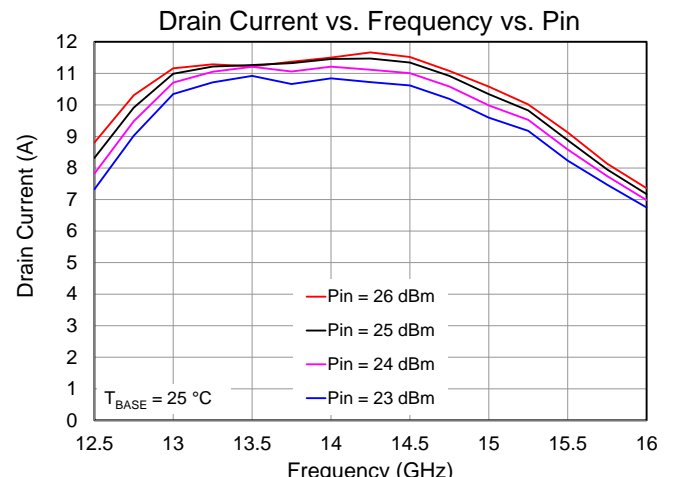
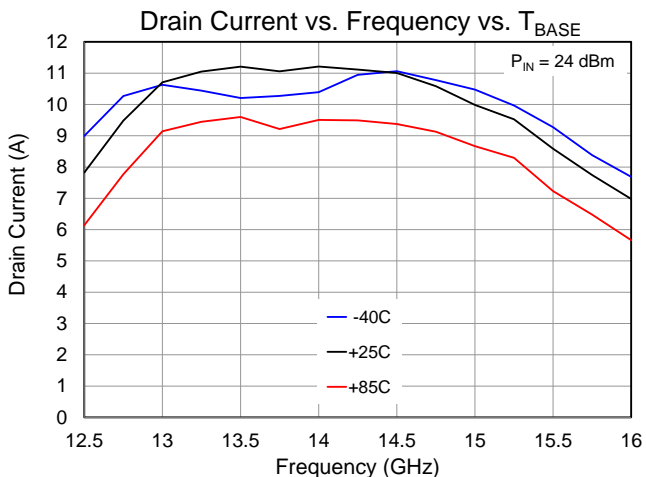
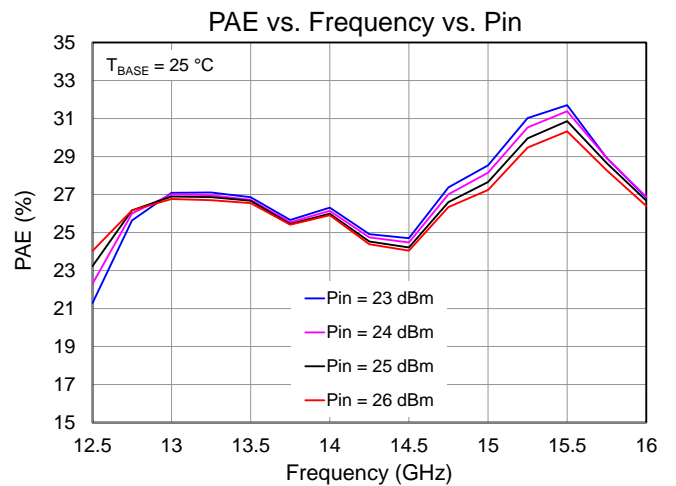
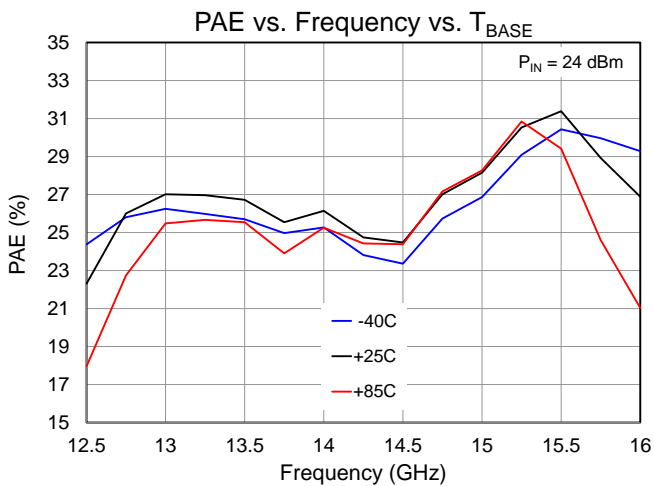
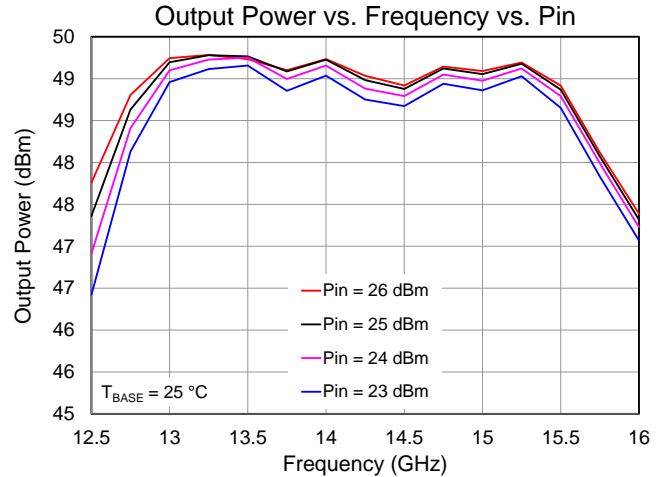
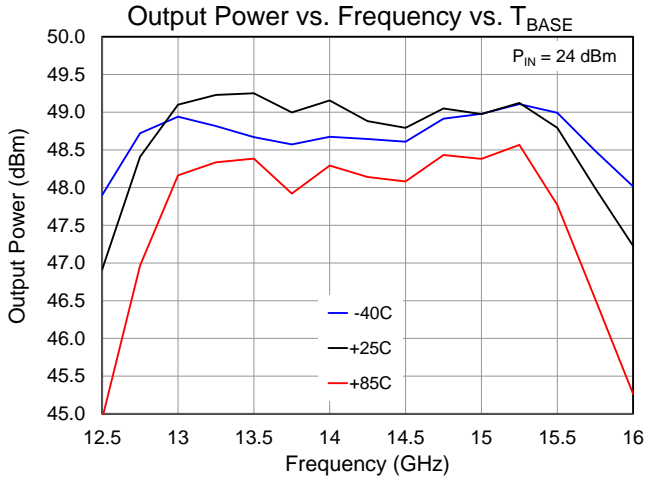

Performance Plots – Large Signal

Test conditions unless otherwise noted: CW, $V_D = 28\text{ V}$, $I_{DQ} = 800\text{ mA}$, $T_{BASE} = +25\text{ }^\circ\text{C}$

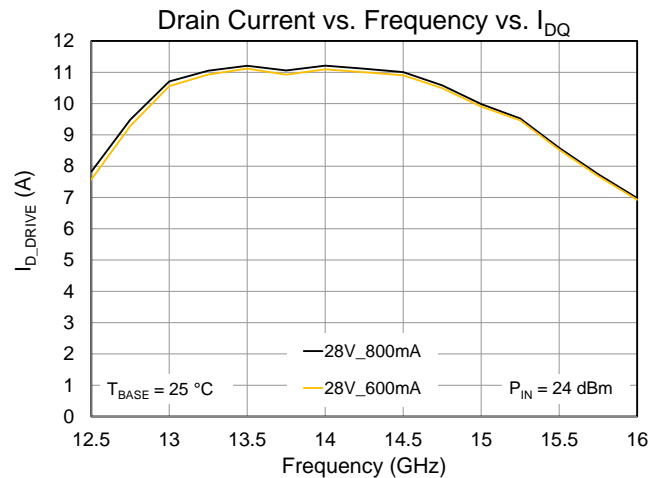
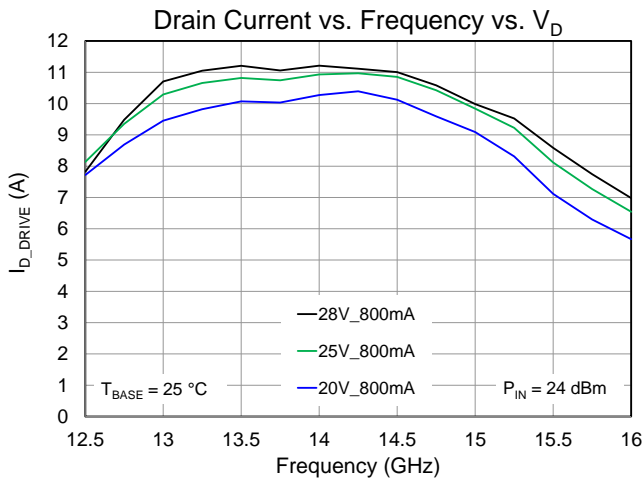
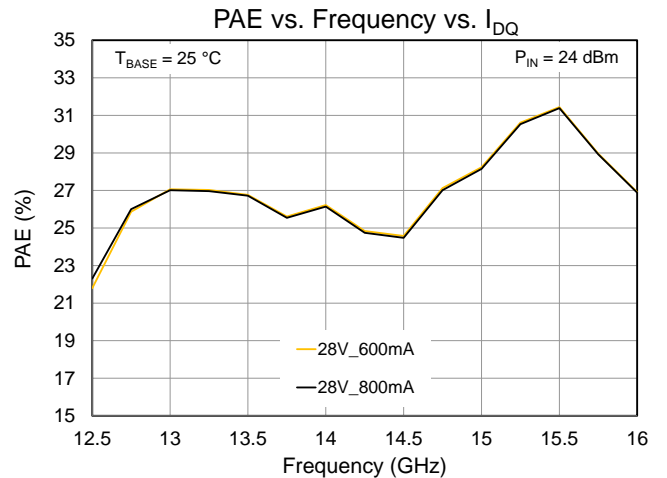
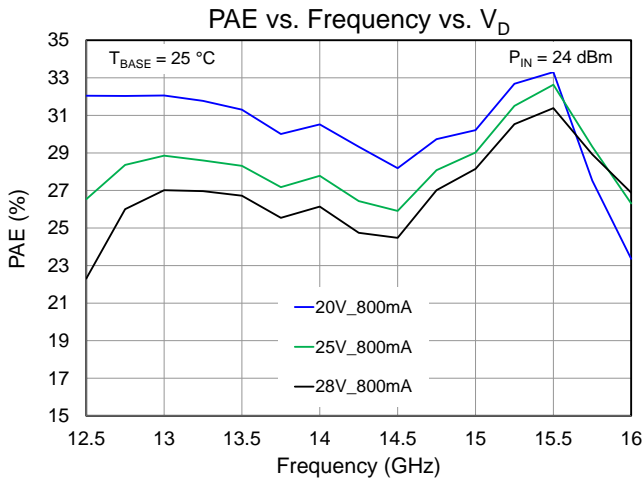
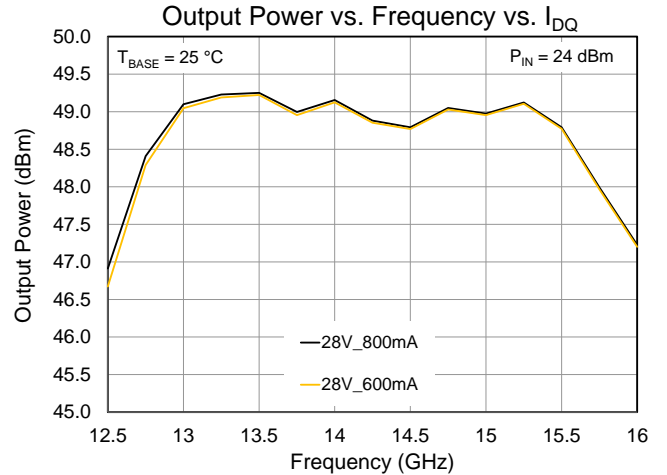
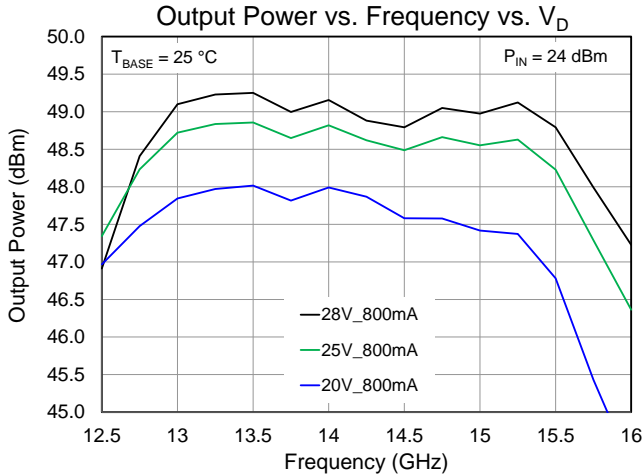

Performance Plots – Large Signal

Test conditions unless otherwise noted: CW, $V_D = 28\text{ V}$, $I_{DQ} = 800\text{ mA}$, $T_{BASE} = +25\text{ }^\circ\text{C}$

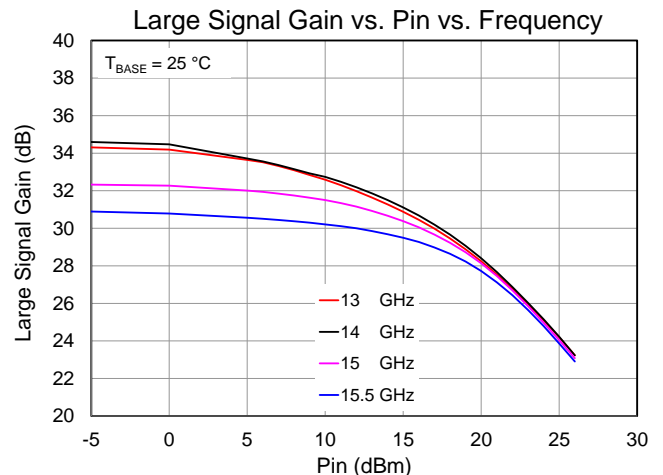
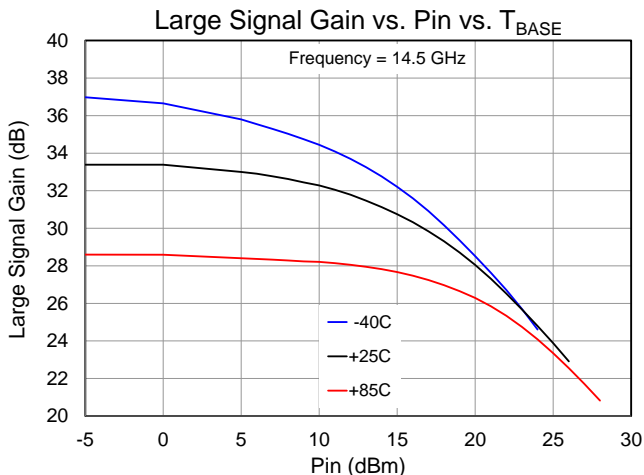
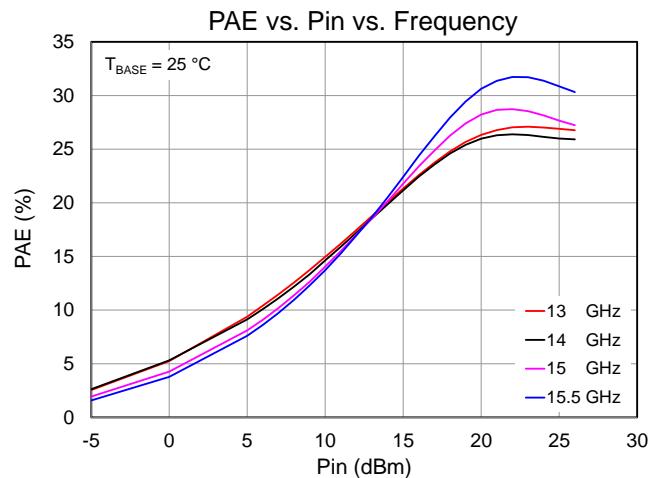
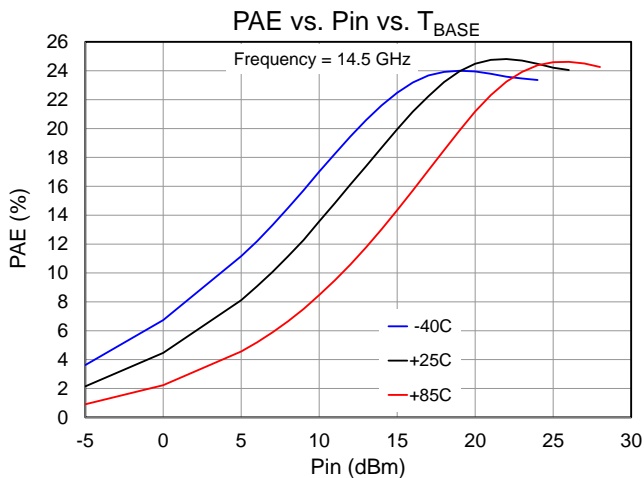
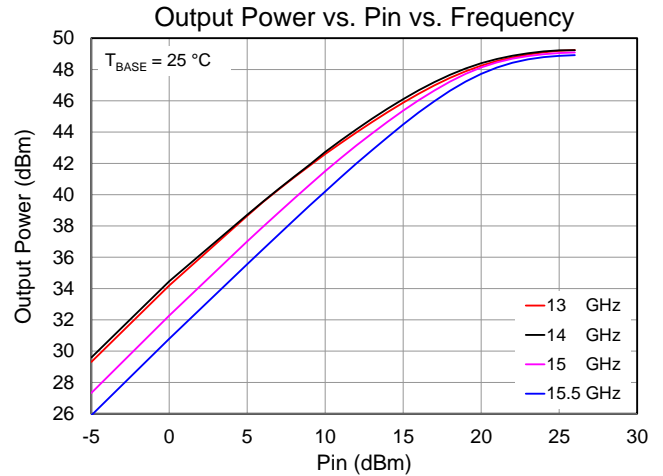
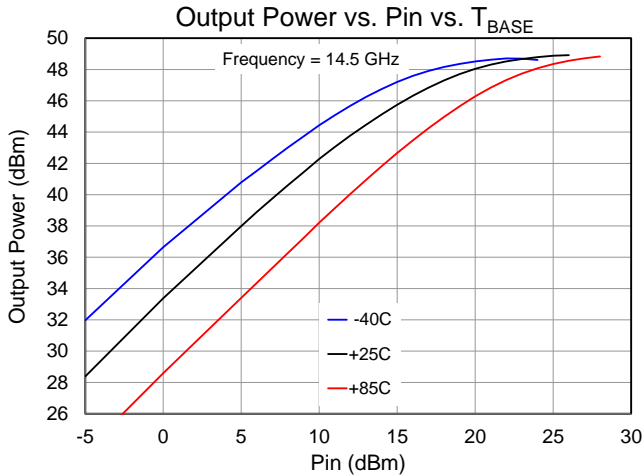

Performance Plots – Large Signal

Test conditions unless otherwise noted: CW, $V_D = 28\text{ V}$, $I_{DQ} = 800\text{ mA}$, $T_{BASE} = +25\text{ }^\circ\text{C}$

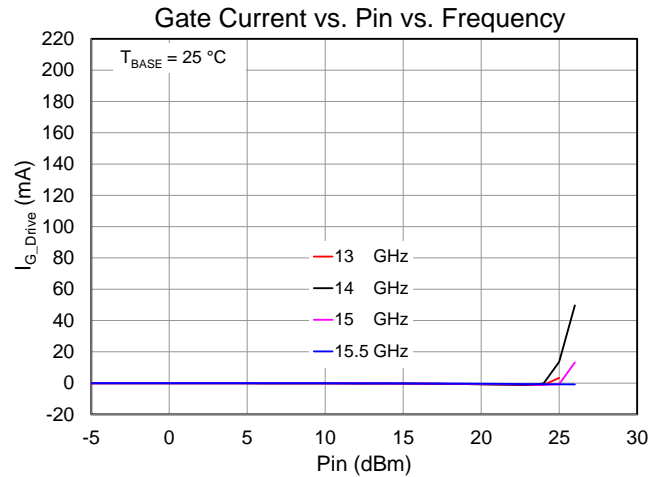
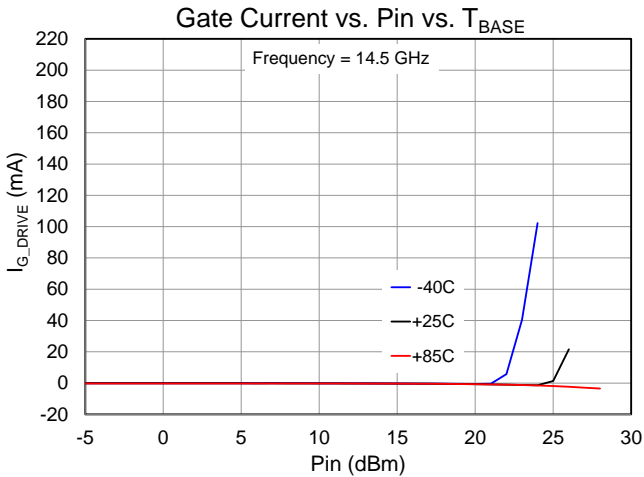
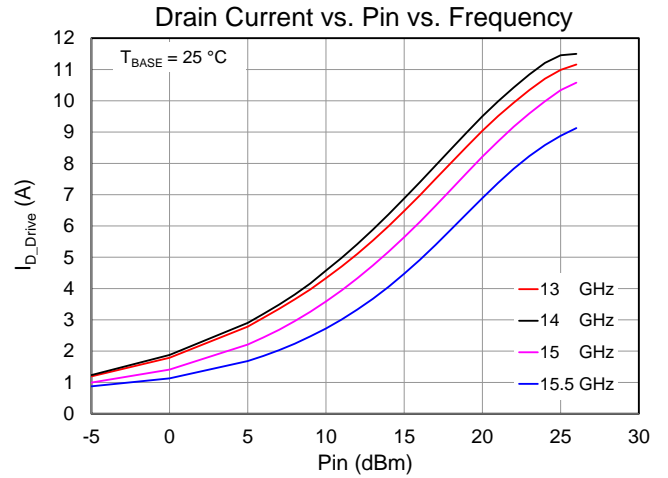
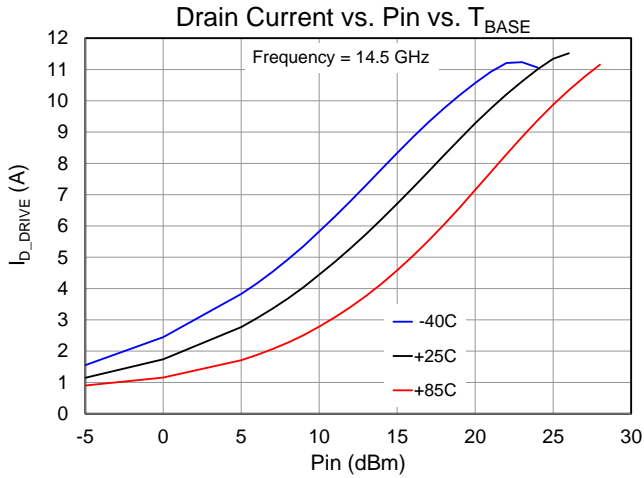

Performance Plots – Linearity

Test conditions unless otherwise noted: CW, $V_D = 28\text{ V}$, $I_{DQ} = 800\text{ mA}$, Tone Spacing = 10 MHz, $T_{BASE} = +25\text{ }^\circ\text{C}$

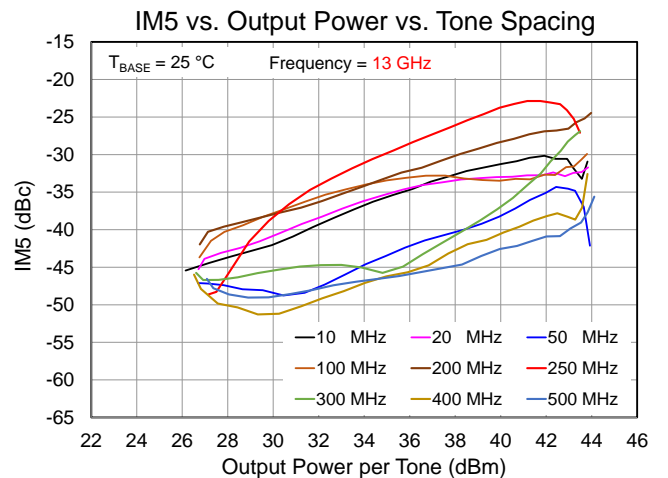
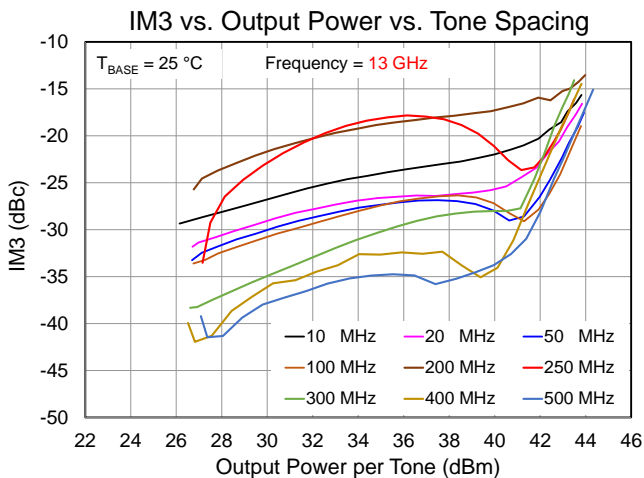
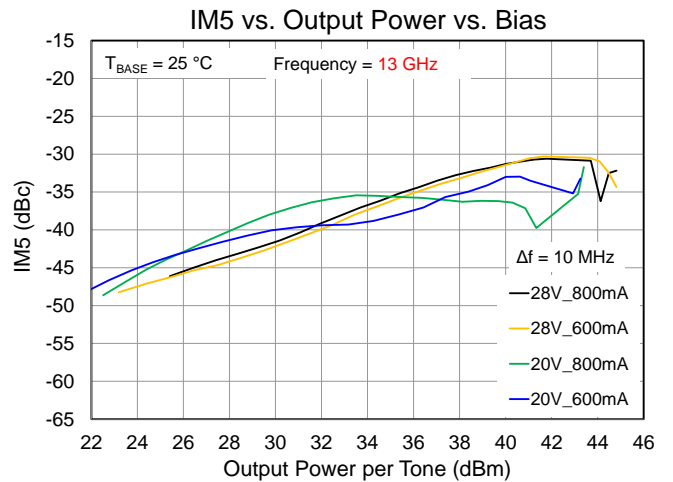
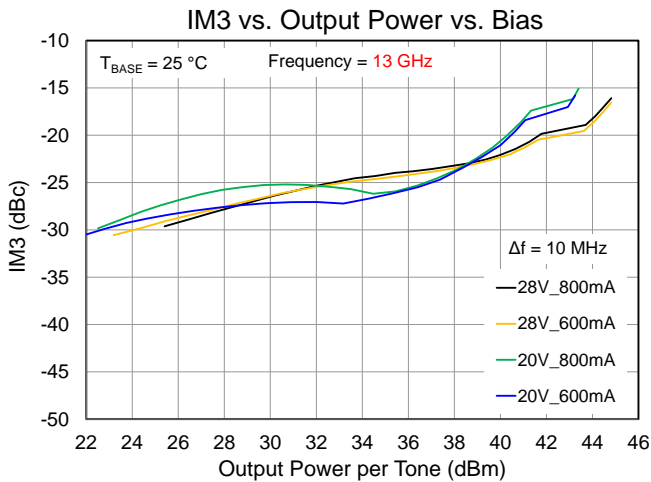
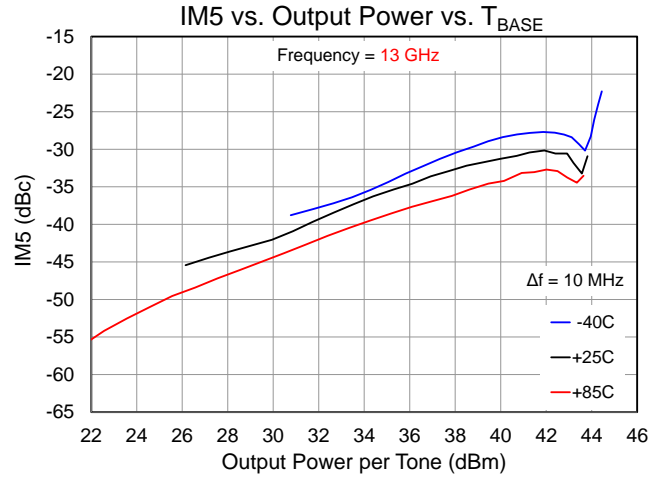
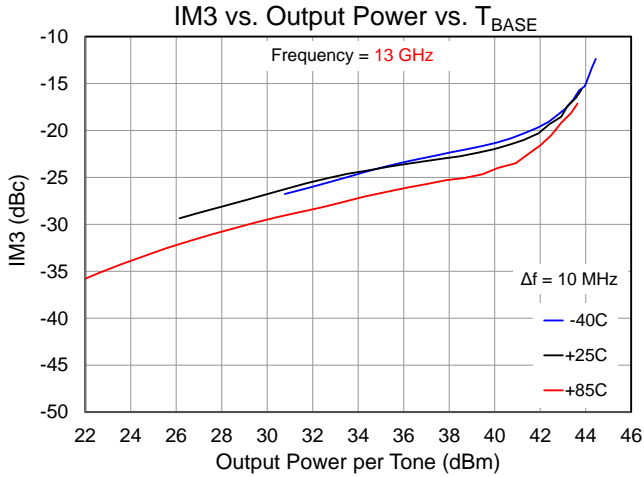

Performance Plots – Linearity

Test conditions unless otherwise noted: CW, $V_D = 28\text{ V}$, $I_{DQ} = 800\text{ mA}$, Tone Spacing = 10 MHz, $T_{BASE} = +25\text{ }^\circ\text{C}$

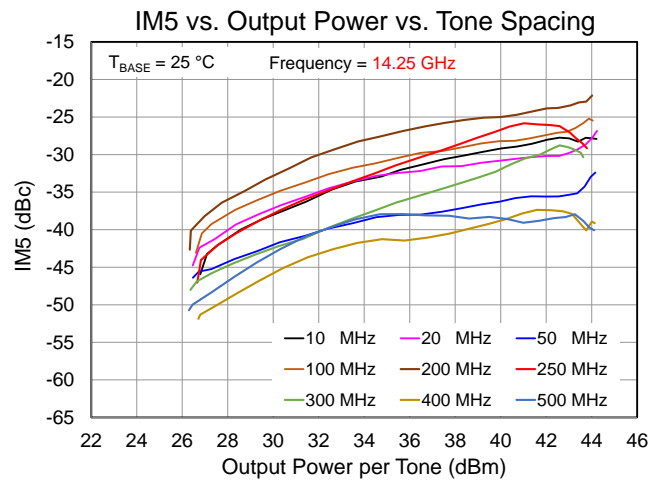
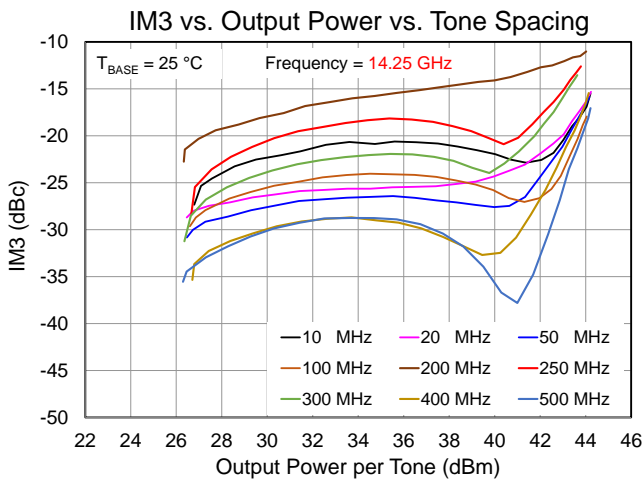
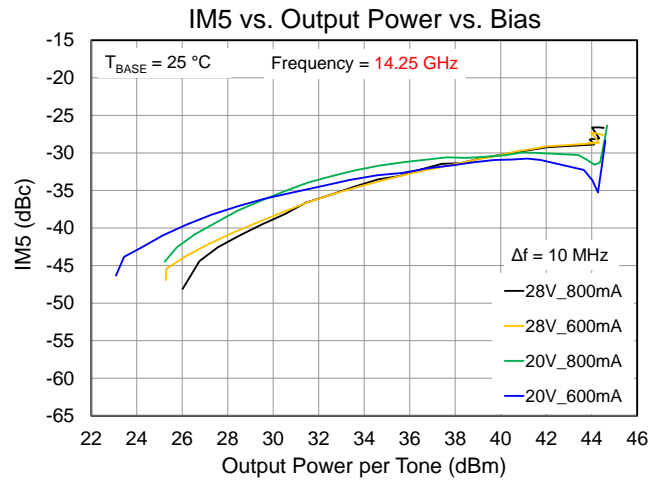
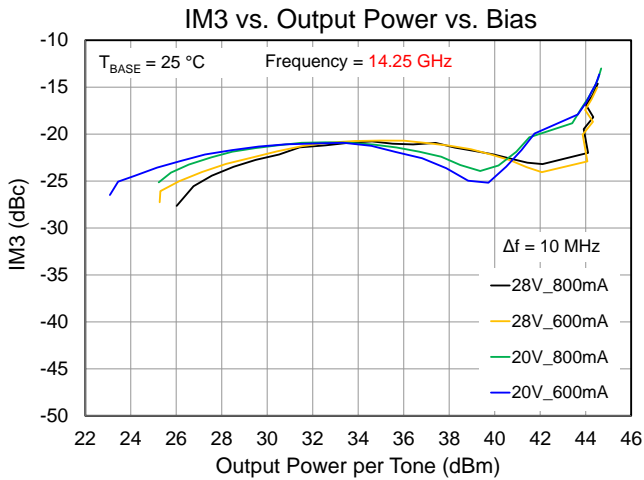
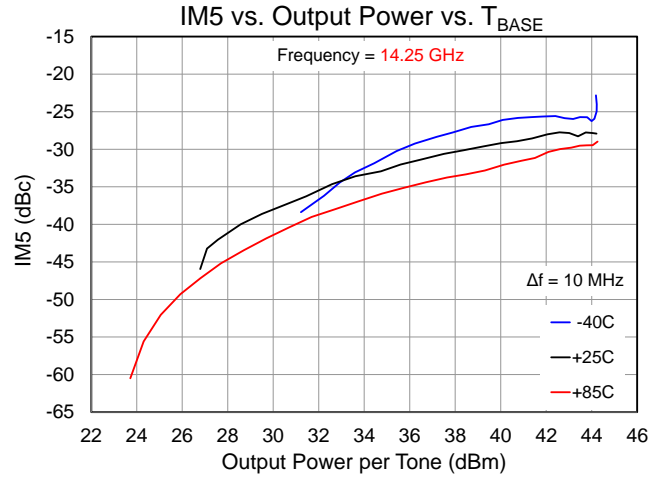
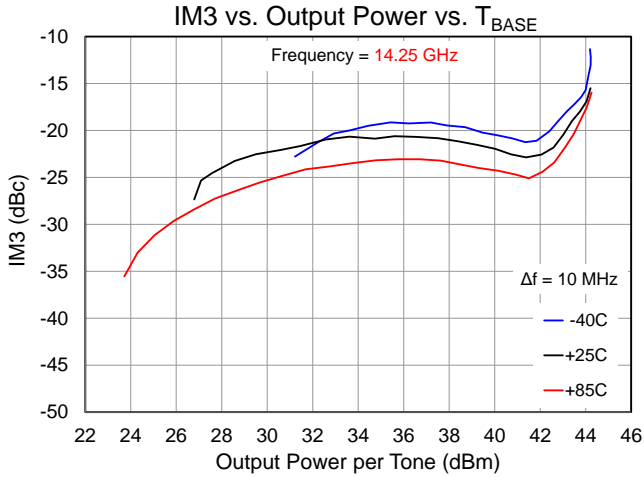

Performance Plots – Linearity

Test conditions unless otherwise noted: CW, $V_D = 28\text{ V}$, $I_{DQ} = 800\text{ mA}$, Tone Spacing = 10 MHz, $T_{BASE} = +25\text{ }^\circ\text{C}$

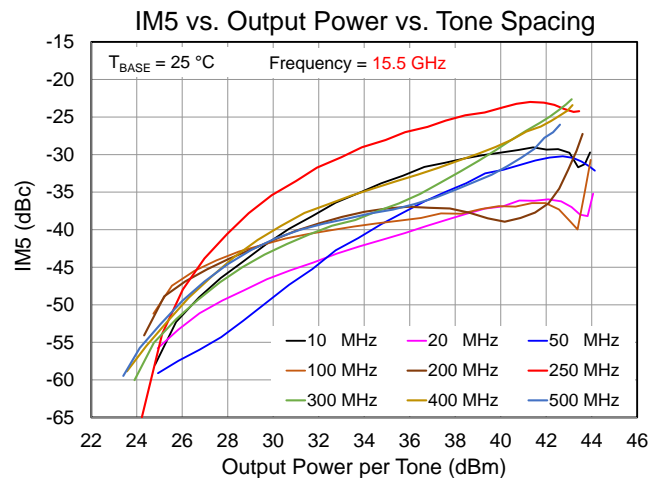
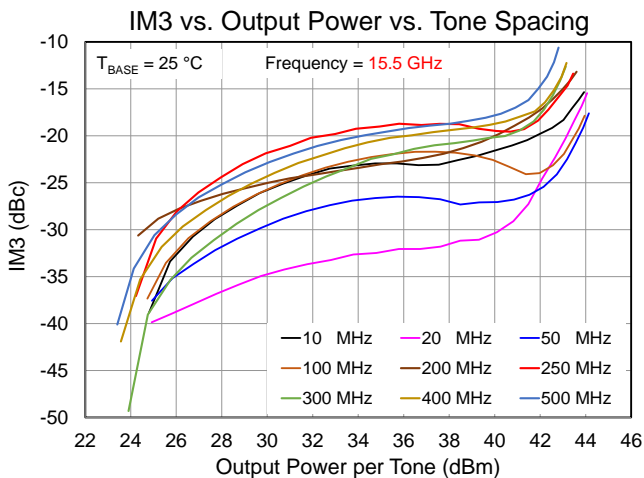
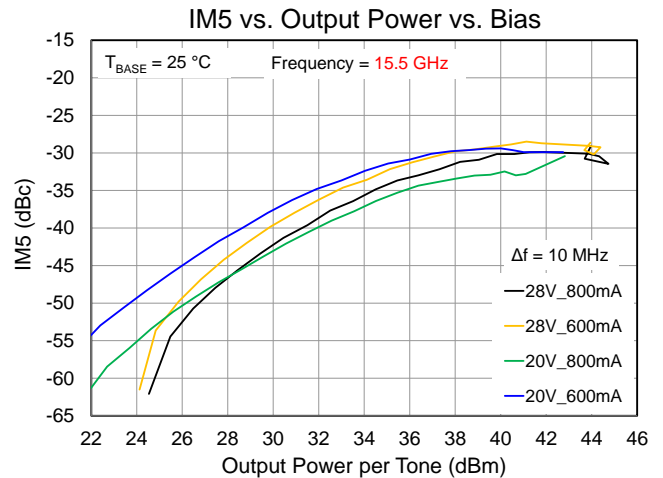
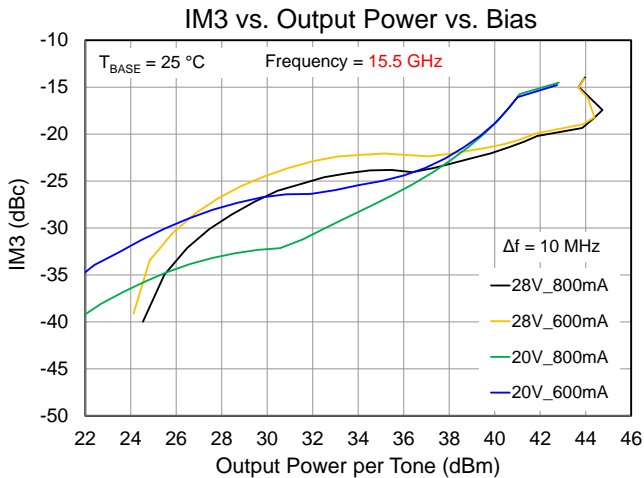
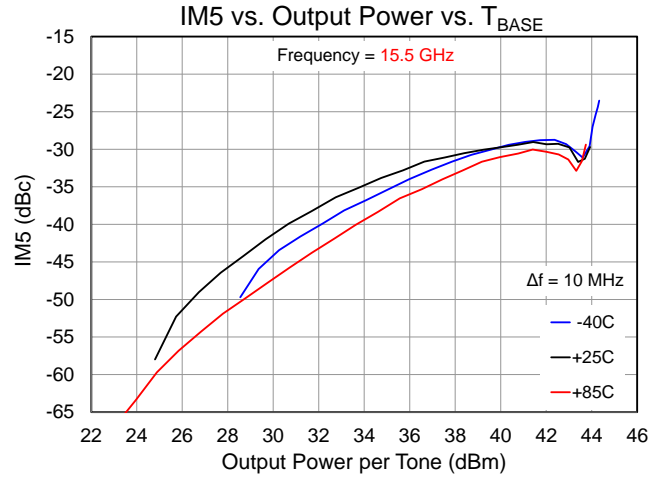
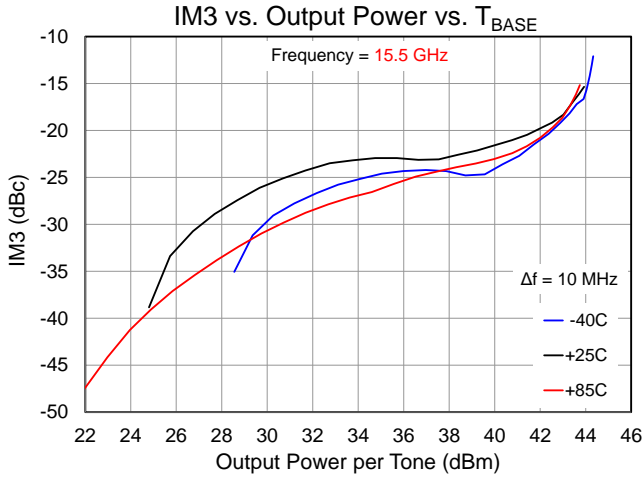

Performance Plots – Linearity

Test conditions unless otherwise noted: CW, $V_D = 28\text{ V}$, $I_{DQ} = 800\text{ mA}$, $T_{BASE} = +25\text{ }^\circ\text{C}$

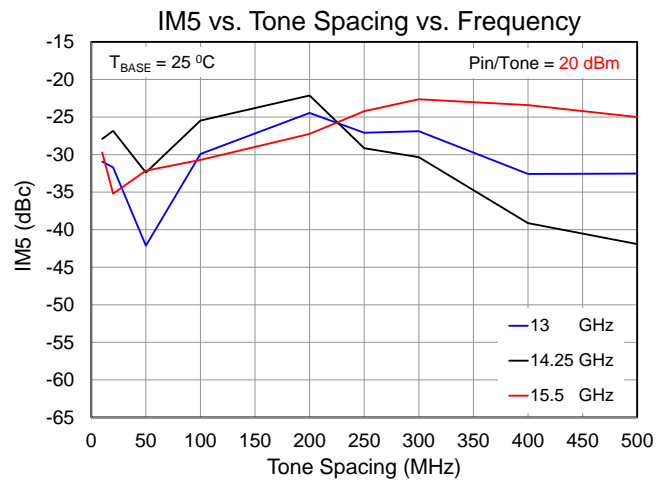
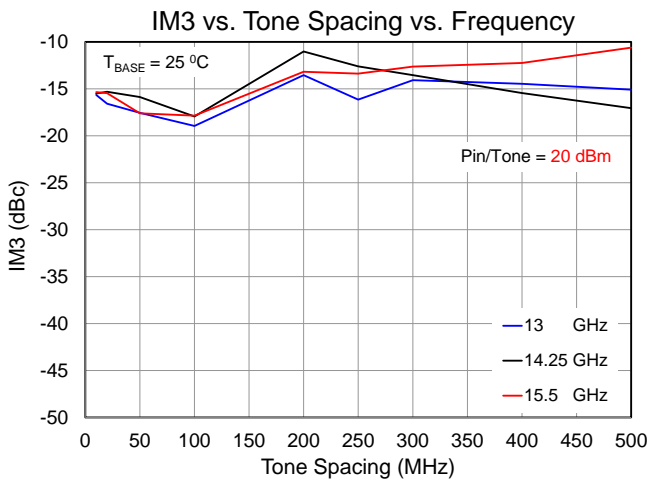
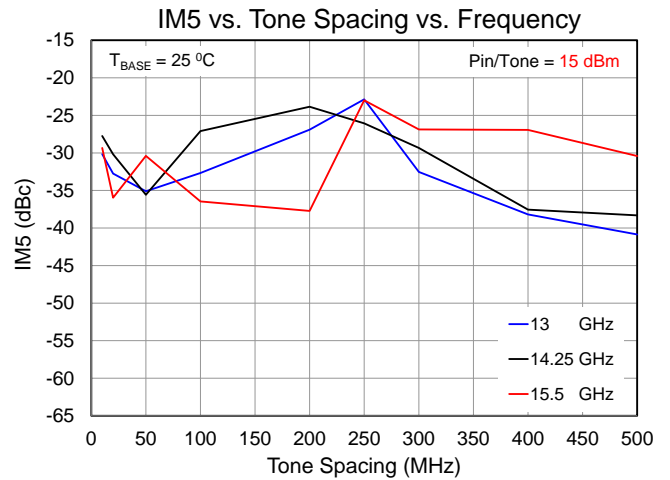
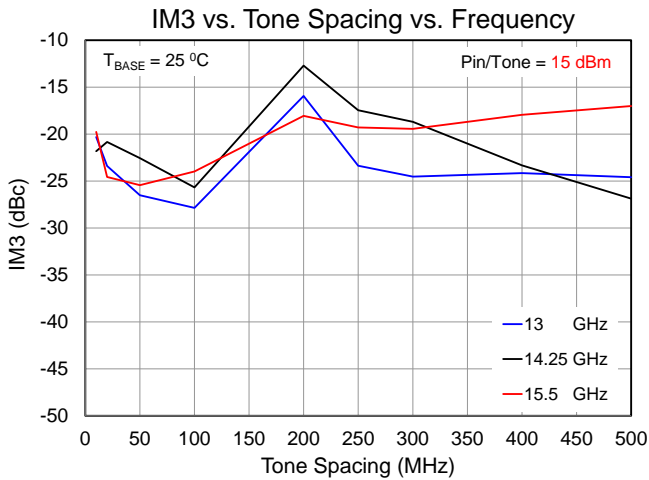
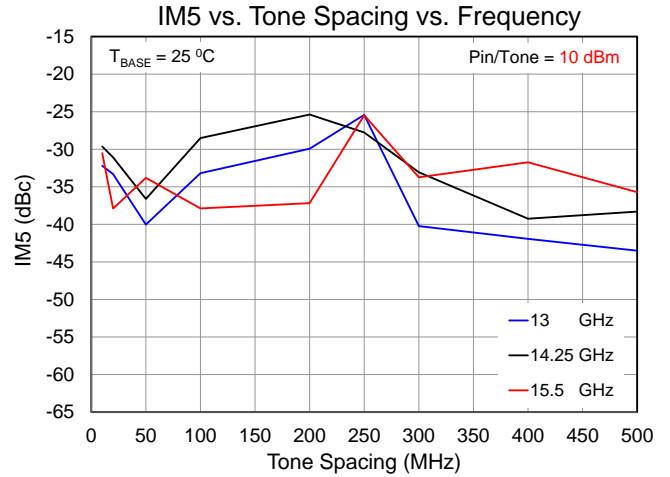
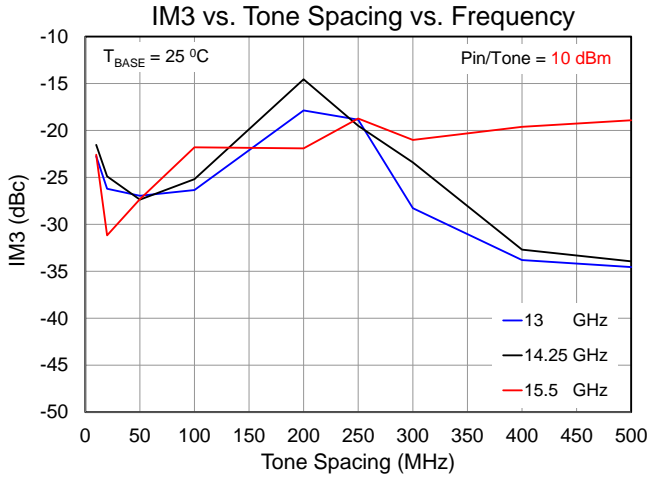

Performance Plots – Harmonic

Test conditions unless otherwise noted: CW, $V_D = 28\text{ V}$, $I_{DQ} = 800\text{ mA}$, $T_{BASE} = +25\text{ }^\circ\text{C}$

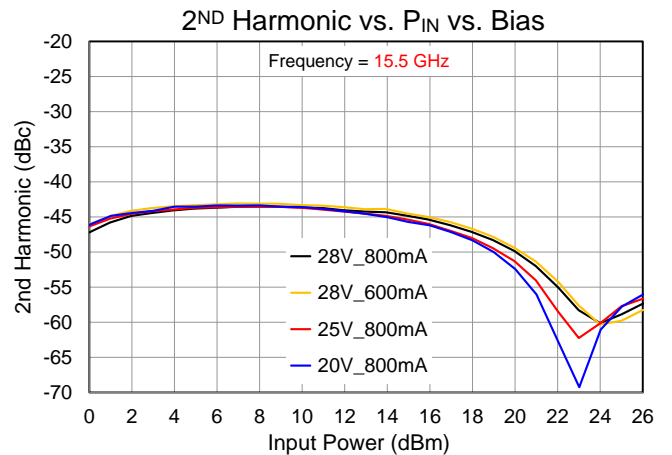
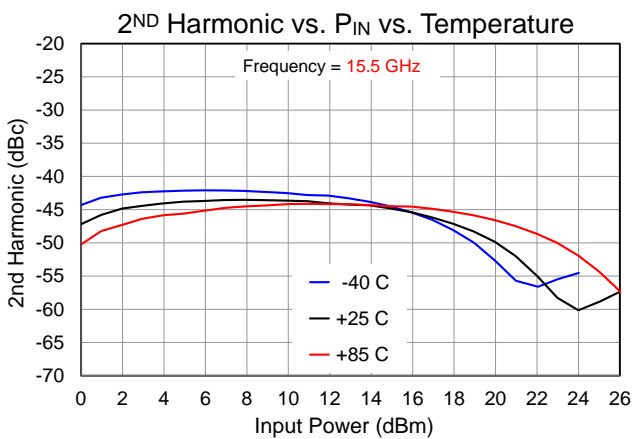
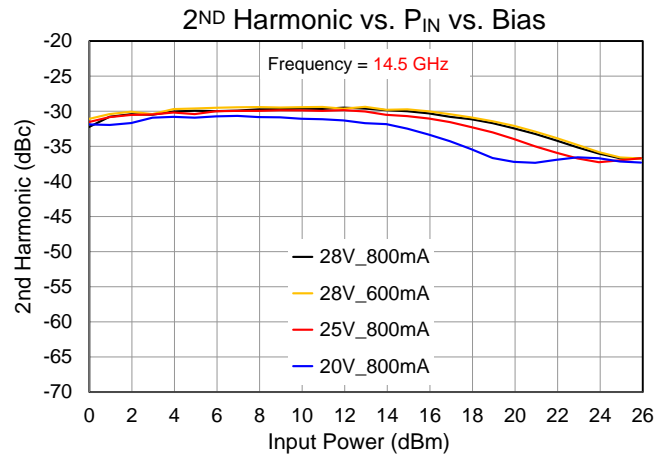
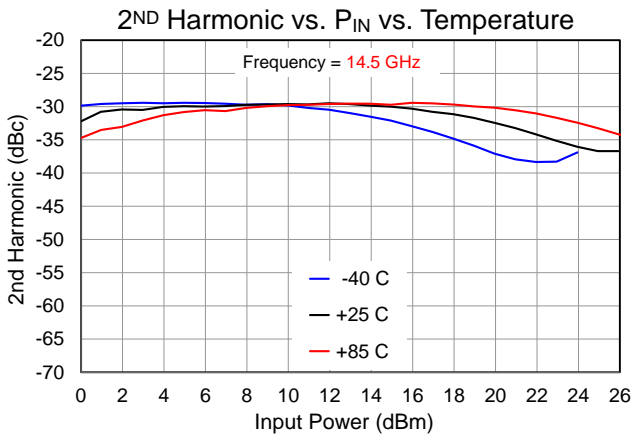
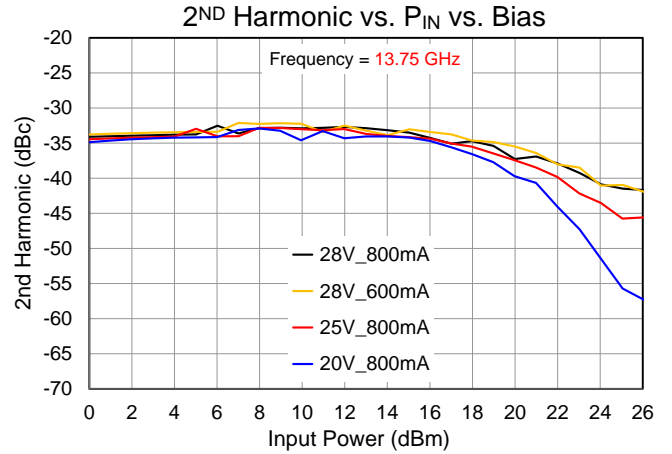
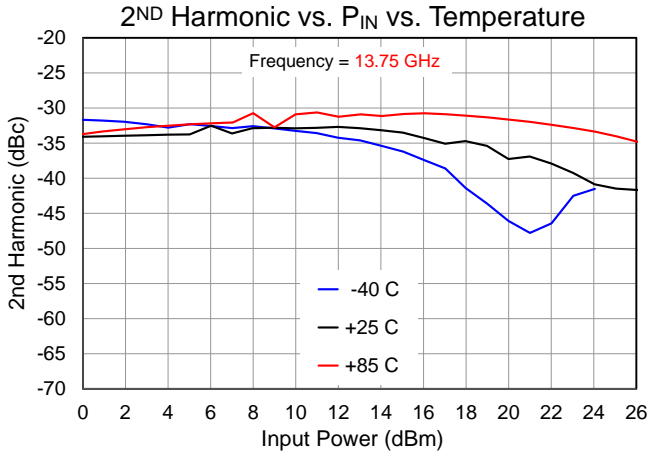

Performance Plots – Small Signal

Test conditions unless otherwise noted: CW, $V_D = 28\text{ V}$, $I_{DQ} = 800\text{ mA}$, $T_{BASE} = +25\text{ }^\circ\text{C}$

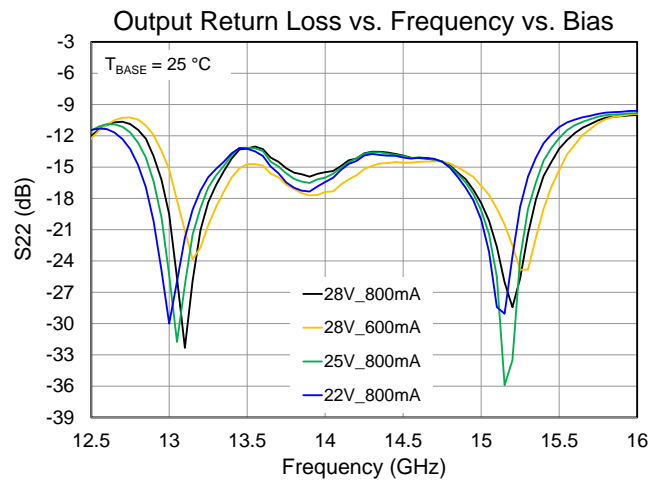
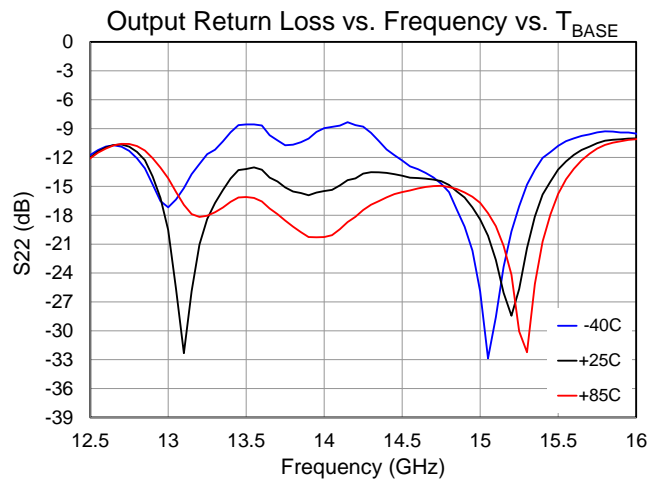
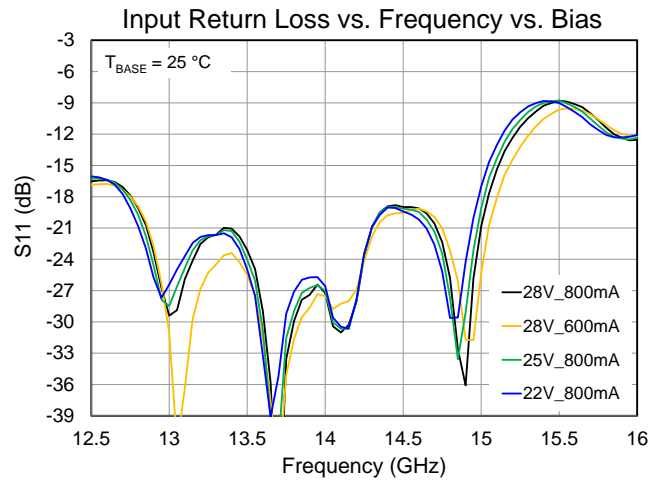
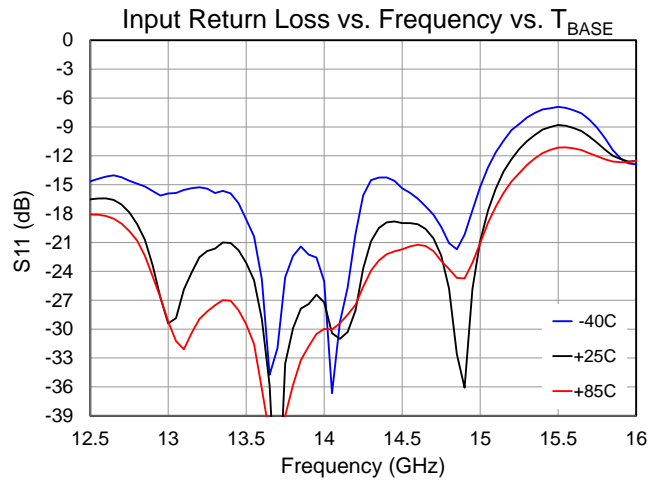
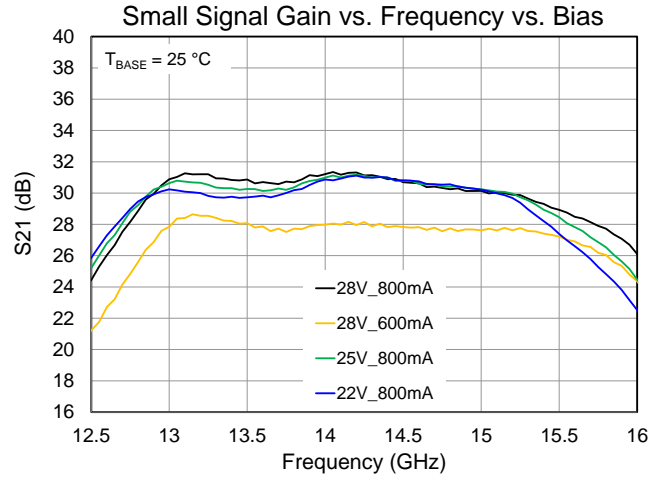
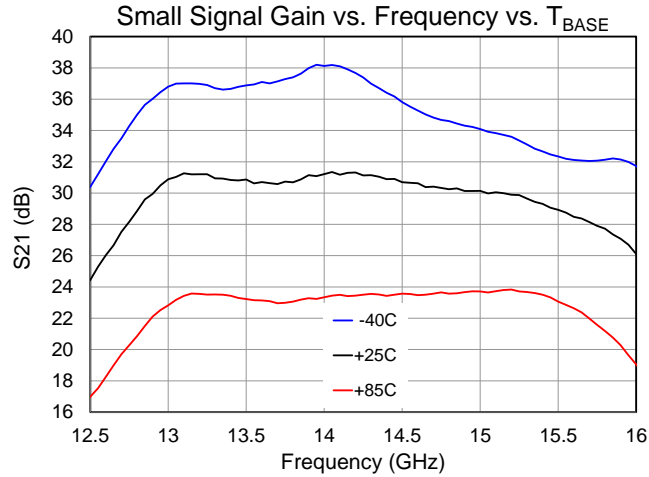

Thermal and Reliability Information

Parameter	Test Conditions	Value	Units
Thermal Resistance (θ_{JC}) ⁽¹⁾	$T_{BASE} = 85\text{ }^{\circ}\text{C}$	0.49	$^{\circ}\text{C/W}$
Channel Temperature, T_{CH} (Quiescent) ⁽²⁾	$V_D = 28\text{ V}$, $I_{DQ} = 800\text{ mA}$ $P_{DISS} = 22.4\text{ W}$	96	$^{\circ}\text{C}$
Thermal Resistance (θ_{JC}) ⁽¹⁾	$T_{BASE} = 85\text{ }^{\circ}\text{C}$, CW $V_D = 28\text{ V}$, $I_{DQ} = 800\text{ mA}$, Freq = 14.5 GHz, $I_{D_DRIVE} = 9.9\text{ A}$, $P_{IN} = 25\text{ dBm}$, $P_{OUT} = 48.5\text{ dBm}$	0.49	$^{\circ}\text{C/W}$
Channel Temperature, T_{CH} (Under RF) ⁽²⁾	$P_{DISS} = 207\text{ W}$	186	$^{\circ}\text{C}$

Notes:

1. Thermal resistance determined to the back of package (85 °C)
2. Channel temperature indicated is an IR scan equivalent temperature. Thermal resistance is calculated using this value. Additional information can be found in the Qorvo Applications Note “GaN Device TCHMAX Theta-JC and Reliability Estimates,” located here <https://www.qorvo.com/products/d/da006480>

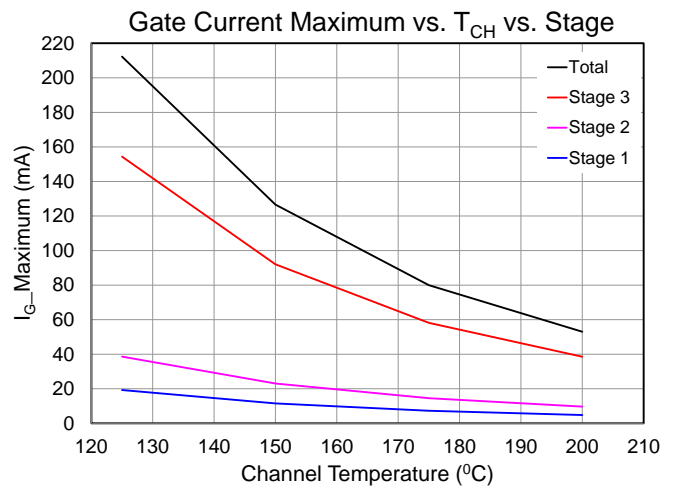
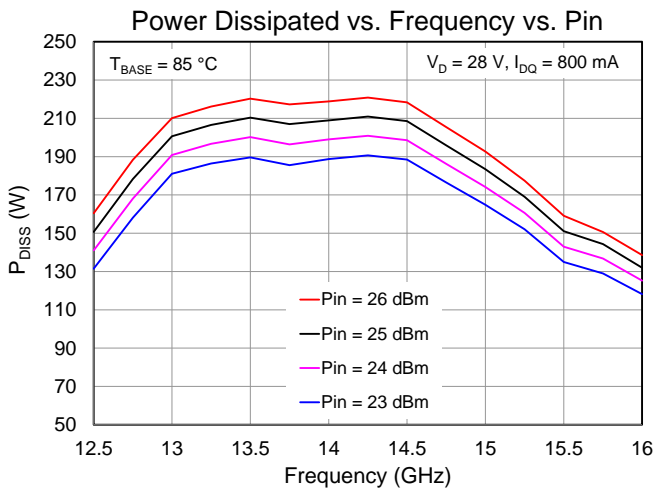

Applications Circuit

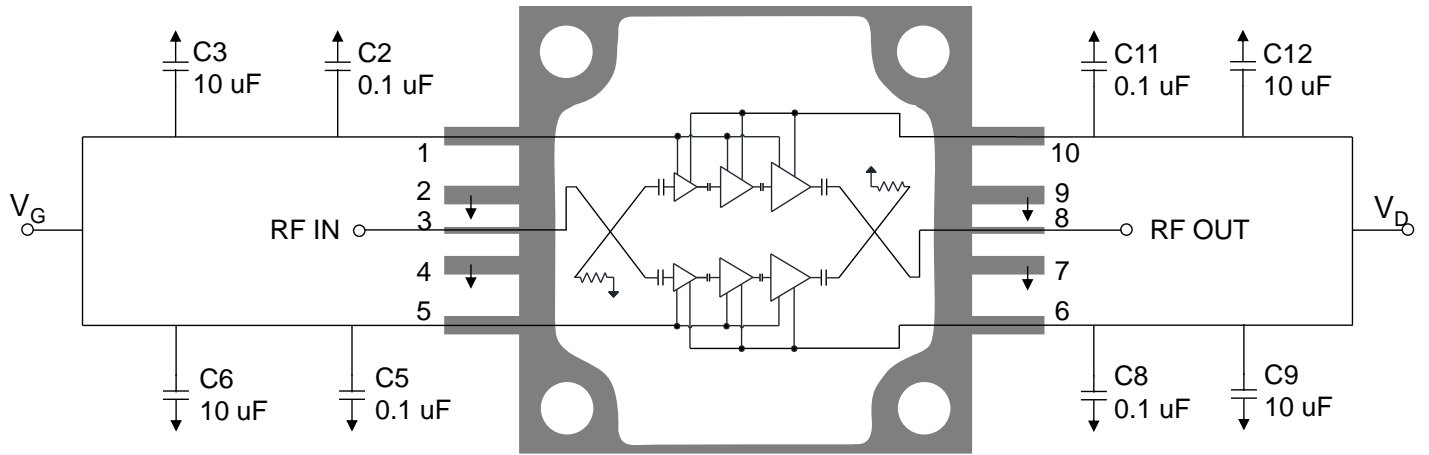

Notes:

1. V_G & V_D must be biased from both sides.

Bias-Up Procedure

1. Set I_D limit to 12.5A, I_G limit to 100 mA
2. Set V_G to -5.0 V. Ensure $I_{DQ} \sim 0mA$
3. Set V_D +28 V
4. Adjust V_G more positive until $I_{DQ} = 800$ mA, $V_G \sim -2.5$ V +/- typical
5. Apply RF signal

Bias-Down Procedure

1. Turn off RF signal
2. Reduce V_G to -5.0 V. Ensure $I_{DQ} \sim 0mA$
4. Set V_D to 0 V
5. Turn off V_D supply
6. Turn off V_G supply

Application Evaluation Board (EVB)

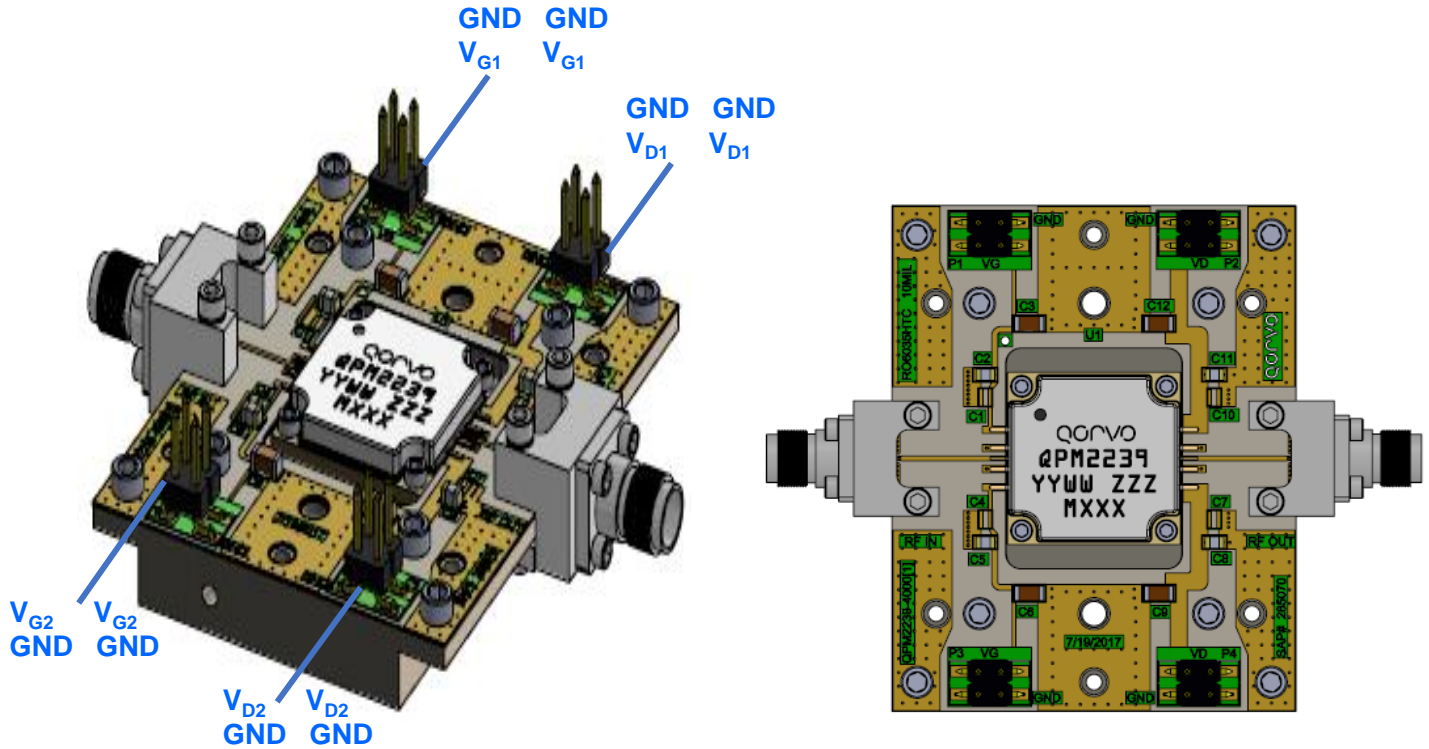

Bill of Materials

Reference Des.	Value	Description	Manuf.	Part Number
U1	-	QPM2239-SM	Qorvo	
C2, C5, C8, C11	0.1 uF	CAP, 0.1uF, 10%, 50V, X7R, 0805	Various	
C3, C6, C9, C12	10 uF	CAP, 10uF, 20%, 50V, X5R, 1206	Various	
H1, H2, H3, H4	-	Header, connector 2x2, SMD	Various	
S1 – S7	-	Screw, Cap, socket head, 2-56x1/8"	Various	
S9 – S12	-	Screw, Cap, socket head, 0-80x3/32'	Various	
J1, J2	SMA	Female End Launch Connector	Southwest Microwave	292-04A-5
PCB	-	Rogers 6035HTC, 10 mil dielectric, 0.5 oz. copper (gold plated), 2 layers	Rogers Corp.	
Carrier	-	T-Carrier, Copper C110, 1.744 x 2.201 x 0.275"		Custom, Qorvo
Solder	-	Paste, solder, syntech, Sn62/Pb36/Ag2	Inventec Performance Chemicals USA	Syntech, SN62, T3, 90.5, 250J
Epoxy	-	Epoxy, Ablebond 84-1LMI 3cc	Henkel Corporation	84-1LMI
Thermal Compound	-	Chem, thermal compound, Silver GR	Arctic Silver	Artic Silver 5 AS5-3.5G

Mechanical Information

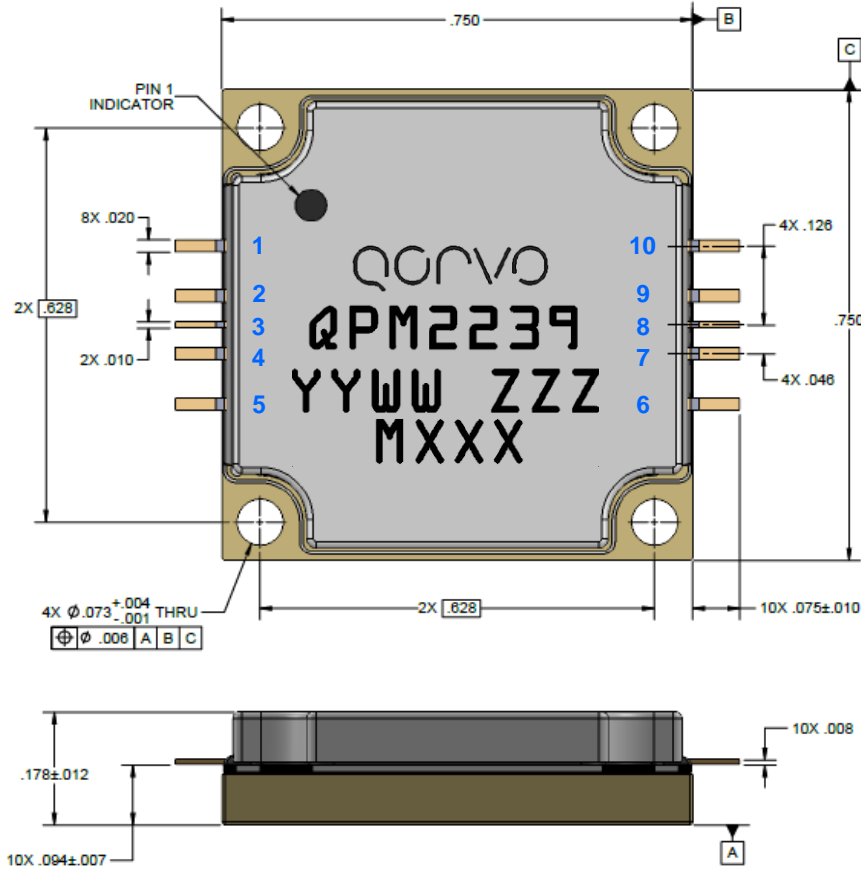

Notes:

- Materials:
 - Package base: Copper
 - Finish : Gold
 - Leads : Alloy 194
 - Finish : Gold
 - LID : LCP (Liquid Crystal Polymer)
- Part is epoxy sealed
- Part Marking:
 - QPM2239-CP: Part number
 - YY: Part assembly year
 - WW: Part assembly week
 - ZZZ: Serial number
 - MXXX: Batch ID
- Dimensions: inches
- Tolerances:
 - .XX: ± 0.01
 - .XXX: ± 0.005
 - .XXXX: ± 0.0010
 - Angles: ± 0.5°

Pin Description

Pin No.	Symbol	Description
1	V _{G1}	Gate voltage Amp 1. Bias network is required; see recommended Application Circuit on page 14
2, 4, 7, 9	Ground	Must be grounded to PCB
3	RF _{IN}	RF Input; matched to 50 Ω, DC blocked
5	V _{G2}	Gate voltage Amp 2. Bias network is required; see recommended Application Circuit on page 14
6	V _{D2}	Drain voltage Amp 2. Bias network is required; see recommended Application Circuit on page 14
8	RF _{OUT}	RF Output; matched to 50 Ω, DC blocked
10	V _{D1}	Drain voltage Amp 1. Bias network is required; see recommended Application Circuit on page 14

Assembly Notes

1. Carefully clean the PC board and package leads with alcohol. Allow it to dry fully.
2. To improve the thermal and RF performance, Qorvo recommends attaching a heat sink to the bottom of the PCB and apply thermal compound (Arctic Silver 5 recommended) or 4 mil indium shim between the heat sink and the package.
3. (The following is for *information only*. There are many variables in a second level assembly that Qorvo does not control, so Qorvo does not recommend an absolute torque value.) Use screws to attach the component to the heat sink. A suggested torque value is 16 in-oz. for a 0-80 screw. Start with screws finger tight, then torque to 8 in-oz., then torque to final value. Use the following tightening pattern:

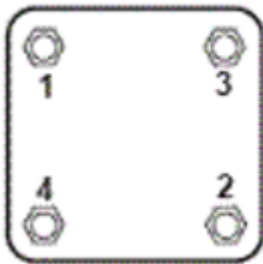

4. Apply no-flux solder to each pin of the QPA3055P. The component leads should be manually soldered, and the package should not be subjected to conventional reflow processes. The use of no-clean solder to avoid washing after soldering is recommended.

Solderability

- The component leads should be manually soldered, and the package cannot be subjected to conventional reflow processes.
- Soldering of the component leads is compatible with the latest version of J-STD-020, lead-free solder, 260 °C
- The use of no-clean solder to avoid washing after soldering is recommended

Handling Precautions

Parameter	Rating	Standard
ESD – Human Body Model (HBM)	0B	ANSI/ESD/JEDEC JS-001
ESD – Charged Device Model (CDM)	C2A	ANSI/ESD/JEDEC JS-002
MSL – Moisture Sensitivity Level	N/A	Blank, null, no content



Caution!
ESD-Sensitive Device

RoHS Compliance

This part is compliant with 2011/65/EU RoHS directive (Restrictions on the Use of Certain Hazardous Substances in Electrical and Electronic Equipment) as amended by Directive 2015/863/EU.

This product also has the following attributes:

- Product uses RoHS Exemption 7c-I to meet RoHS Compliance requirements.
- Halogen Free (Chlorine, Bromine)
- Antimony Free
- TBBP-A (C₁₅H₁₂Br₄O₂) Free
- PFOS Free
- SVHC Free

Contact Information

For the latest specifications, additional product information, worldwide sales and distribution locations:

Web: www.qorvo.com

Tel: 1-844-890-8163

Email: customer.support@qorvo.com

Important Notice

The information contained herein is believed to be reliable; however, Qorvo makes no warranties regarding the information contained herein and assumes no responsibility or liability whatsoever for the use of the information contained herein. All information contained herein is subject to change without notice. Customers should obtain and verify the latest relevant information before placing orders for Qorvo products. The information contained herein or any use of such information does not grant, explicitly or implicitly, to any party any patent rights, licenses, or any other intellectual property rights, whether with regard to such information itself or anything described by such information. **THIS INFORMATION DOES NOT CONSTITUTE A WARRANTY WITH RESPECT TO THE PRODUCTS DESCRIBED HEREIN, AND QORVO HEREBY DISCLAIMS ANY AND ALL WARRANTIES WITH RESPECT TO SUCH PRODUCTS WHETHER EXPRESS OR IMPLIED BY LAW, COURSE OF DEALING, COURSE OF PERFORMANCE, USAGE OF TRADE OR OTHERWISE, INCLUDING THE IMPLIED WARRANTIES OF MERCHANTABILITY AND FITNESS FOR A PARTICULAR PURPOSE.**

Without limiting the generality of the foregoing, Qorvo products are not warranted or authorized for use as critical components in medical, life-saving, or life-sustaining applications, or other applications where a failure would reasonably be expected to cause severe personal injury or death.

Copyright 2018 © Qorvo, Inc. | Qorvo is a registered trademark of Qorvo, Inc.

X-ON Electronics

Largest Supplier of Electrical and Electronic Components

Click to view similar products for [RF Amplifier](#) category:

Click to view products by [Qorvo](#) manufacturer:

Other Similar products are found below :

[A82-1](#) [BGA622H6820XTSA1](#) [BGA 728L7 E6327](#) [BGB719N7ESDE6327XTMA1](#) [HMC397-SX](#) [HMC405](#) [HMC561-SX](#) [HMC8120-SX](#)
[HMC8121-SX](#) [HMC-ALH382-SX](#) [HMC-ALH476-SX](#) [SE2433T-R](#) [SMA3101-TL-E](#) [SMA39](#) [A66-1](#) [A66-3](#) [A67-1](#) [A81-2](#) [LX5535LQ](#)
[LX5540LL](#) [MAAM02350](#) [HMC3653LP3BETR](#) [HMC549MS8GETR](#) [HMC-ALH435-SX](#) [SMA101](#) [SMA32](#) [SMA411](#) [SMA531](#)
[SST12LP19E-QX6E](#) [WPM0510A](#) [HMC5929LS6TR](#) [HMC5879LS7TR](#) [HMC1126](#) [HMC1087F10](#) [HMC1086](#) [HMC1016](#) [SMA1212](#)
[MAX2689EWS+T](#) [MAAMSS0041TR](#) [MAAM37000-A1G](#) [LTC6430AIUF-15#PBF](#) [SMA70-2](#) [SMA4011](#) [A231](#) [HMC-AUH232](#) [LX5511LQ](#)
[LX5511LQ-TR](#) [HMC7441-SX](#) [HMC-ALH310](#) [XD1001-BD-000V](#)