

Product Description

The QPM2637 is a Gallium Nitride MMIC front-end module (FEM) designed for X-Band radar applications within the 9-10.5 GHz range. The MMIC combines a T/R switch, low-noise amplifier, and a power amplifier. The receive path has dual-outputs which offer 21dB gain and 2.7dB noise figure. The transmit path delivers 4W of saturated power with 23dB large signal gain. The FEM is a high robustness device with up to 4W of input power into the ANT port eliminating the need for a limiter.

The QPM2637 is fabricated on Qorvo's QGaN25 0.25um GaN-on-SiC process. The air-cavity EHS (embedded copper heat slug) surface mount package, coupled with a low thermal resistance die-attach process, allows the QPM2637 to perform well at extreme case temperatures. Its compact size supports tight lattice spacing requirements needed for X-Band phased array radar applications.

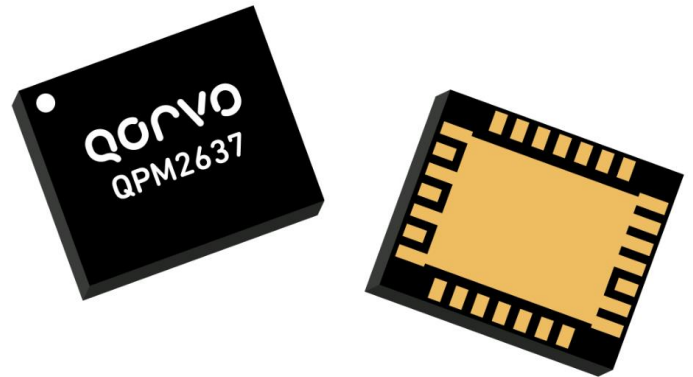

Functional Block Diagram

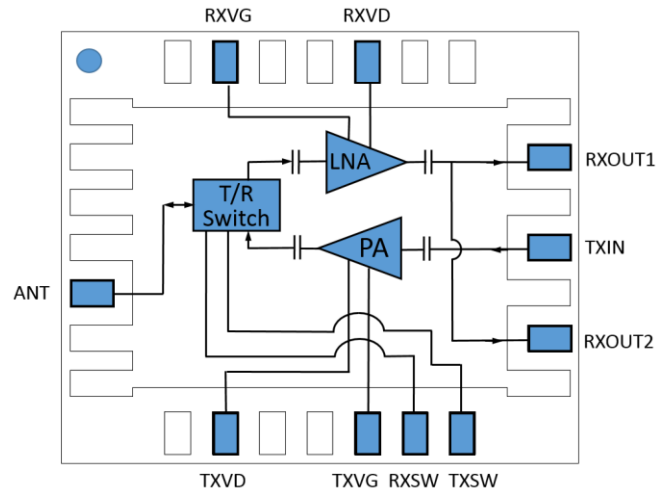

Product Features

- Frequency Range: 9 – 10.5 GHz
- RX Noise Figure: 2.7 dB
- RX Small Signal Gain: 21 dB
- RX OTOI : 21 dBm
- TX Large Signal Gain: 23 dB
- TX Saturated Power: 36 dBm, Pulsed
- TX PAE: 38% @ 36 dBm Pout, Pulsed
- Package Dimensions: 6 x 5 x 1.8 mm
- Switching Time: < 35 nS

*Performance is typical at room temperature.
Please reference electrical specification table and data plots for more details.*

Applications

- Electronics Warfare (EW)
- Commercial and Military Radar
- Communications

Ordering Information

Part No.	Description
QPM2637	QPM2637, Shipping Tray, Qty 10
QPM2637TR7	QPM2637, Tape and Reel, Qty 250
QPM2637EVB	QPM2637 Evaluation Board, Qty 1

Normal Operating Conditions

Parameter	Value	Units
RX Drain Voltage (RXVD)	10	V
RX Drain Quiescent Current (RXIDQ)	30	mA
RX Gate Control (RXVG)	-2.5	V
TX Drain Voltage (TXVD)	28	V
TX Drain Quiescent Current (TXIDQ)	50	mA
TX Gate Voltage (TXVG)	-2.5	V
TX Gate Current (TXIDQ, normal operation)	25	mA
Control Voltage (TXSW / RXSW)	0 or -28	V
Operating Temperature Range	-55 to 100	°C

Gate voltage shown are typical, can be adjusted to set required drain current. Electrical specifications are measured at specified test conditions. Specifications are not guaranteed over all recommended operating conditions.

Absolute Maximum Ratings

Parameter	Min Value	Max Value	Units
Drain Voltage (TXVD and RXVD)	-	32	V
Drain Current (TXID)	-	600	mA
Drain Current (RXID)	-	60	mA
Gate Voltage (RXVG, TXVG)	-5	0	V
Gate Current (RXIG)	-	20	mA
Gate Current (TXIG)	-	100	mA
Switch Control Voltage (TXSW, RXSW)	-50	0	V
Switch Control Current	-	20	mA
RF Input Power (All RF ports, 85 °C)	-	36	dBm
Channel Temperature, T _{CH}	-	225	°C
Mounting Temperature (30 seconds)	-	260	°C
Storage Temperature	-55	150	°C

Operation of this device outside the parameter ranges given above may cause permanent damage. These are stress ratings only, and functional operation of the device at these conditions is not implied. Extended application of Absolute Maximum Rating conditions to the device may reduce device reliability.

Electrical Specifications, Receive

Test conditions unless otherwise noted: 25 °C, RXVD = 10 V, RXIDQ = 30 mA, RXSW = -28 V, TXSW = 0 V, PA off.
Data de-embedded to device reference plane

Parameter	Min	Typical	Max	Units
Frequency	9		10.5	GHz
Small Signal Gain		21		dB
Noise Figure		2.7		dB
Input Return Loss		10		dB
Output Return Loss		23		dB
Output TOI		21		dBm
Gate Leakage Current (RXVG Leak) (RXVD = 10 V, RXVG = -3.7 V, RXSW = -28 V, TXSW = -28 V)	-0.55	-0.01		mA
Switch Settling Time, Rising Edge ¹		5		nS
Switch Settling Time, Falling Edge ²		35		nS
Gain Temperature Coefficient		-0.038		dB/°C

- 1 From 50% trigger signal to 90 % of RF on (Trigger signal to switch driver to DUT)
- 2 From 50% trigger signal to 10 % of RF off (Trigger signal to switch driver to DUT)

Electrical Specifications, Transmit

Test conditions unless otherwise noted: 25 °C, TXVD = 28 V, TXIDQ = 50 mA, RXSW = 0 V, TXSW = -28 V, LNA off.
Data de-embedded to device reference plane

Parameter	Min	Typical	Max	Units
Frequency	9		10.5	GHz
Large Signal Gain		23		dB
Input Return Loss		15		dB
Output Return Loss		8		dB
Saturated Output Power ¹		36		dBm
PAE at Saturated Power (@ 13 dBm Pin)		42		%
Harmonic Suppression up to Saturated Power		30		dBc
Gate Leakage Current (TXVG Leak) (TXVD = 10 V, RXVG = -3.7 V, RXSW = -28 V, TXSW = -28 V)	-2.2	-0.01		mA
Switch Settling Time, Rising Edge ²		30		nS
Switch Settling Time, Falling Edge ³		8		nS
Gain Temperature Coefficient		-0.045		dB/°C

1. Power and PAE measured with DC drain pulsed, PW = 200 uS, Duty Cycle = 10%
2. From 50% trigger signal to 90 % of RF on (Trigger signal to switch driver to DUT)
3. From 50% trigger signal to 10 % of RF off (Trigger signal to switch driver to DUT)

Performance Plots, Receive Channel

Test Conditions unless otherwise stated: RXVD = 10 V, RXIDQ = 30 mA, RXSW = - 28 V, TXSW = 0 V, PA off, 25C
Data de-embedded to device reference plane, Port 1: Common Port, Port 2: RXOUT1, Port 3: RXOUT2

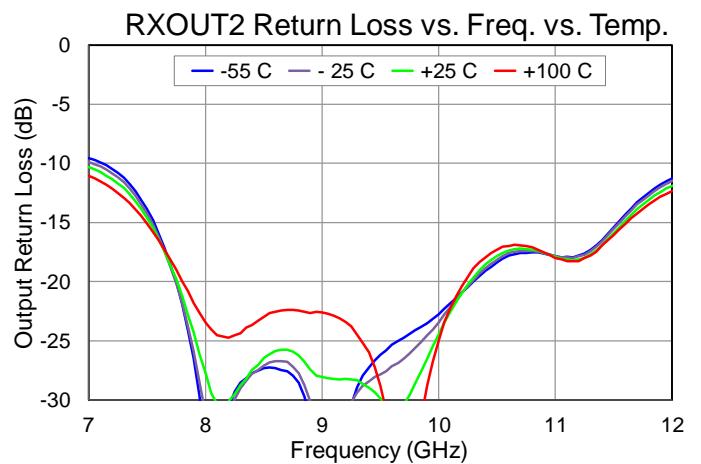
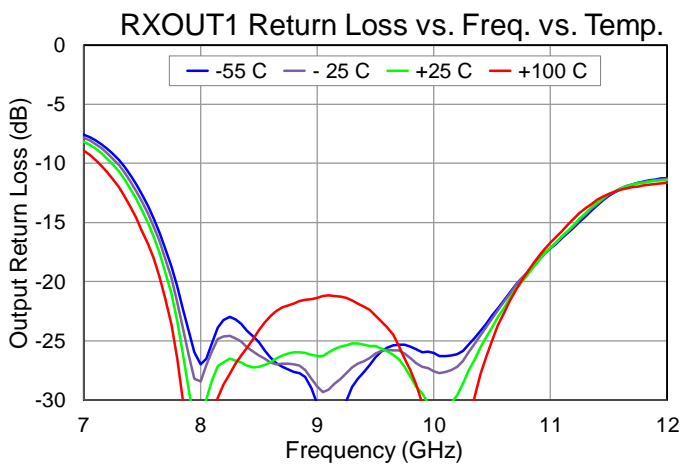
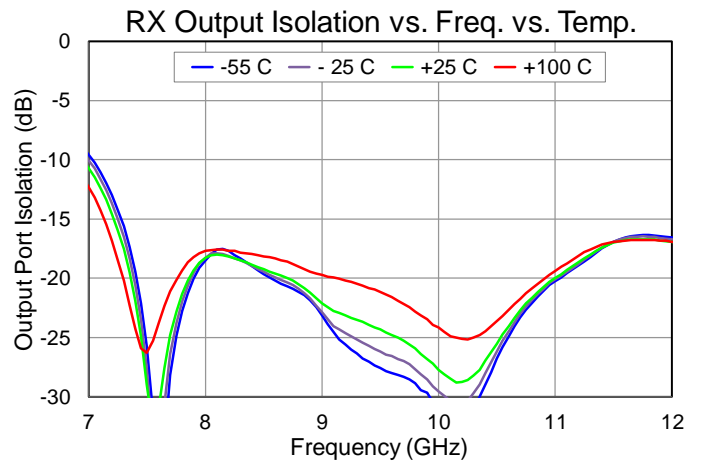
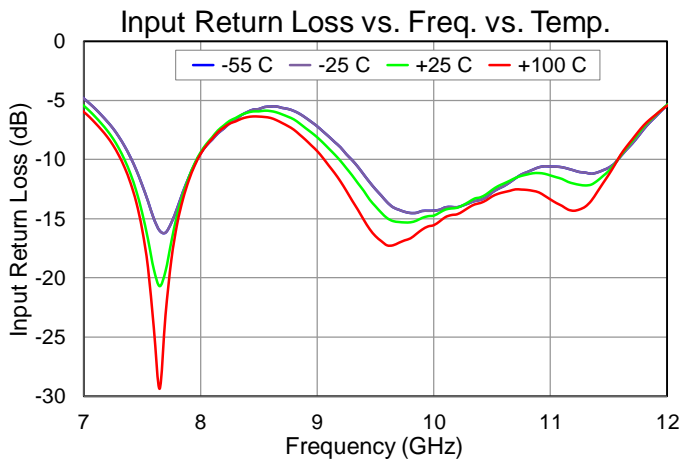
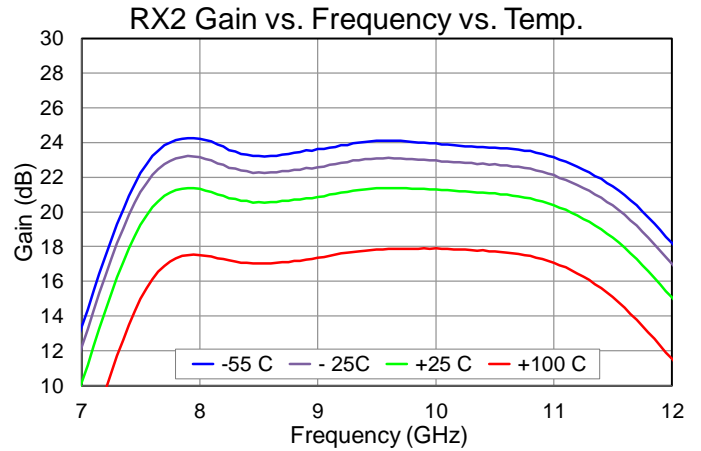
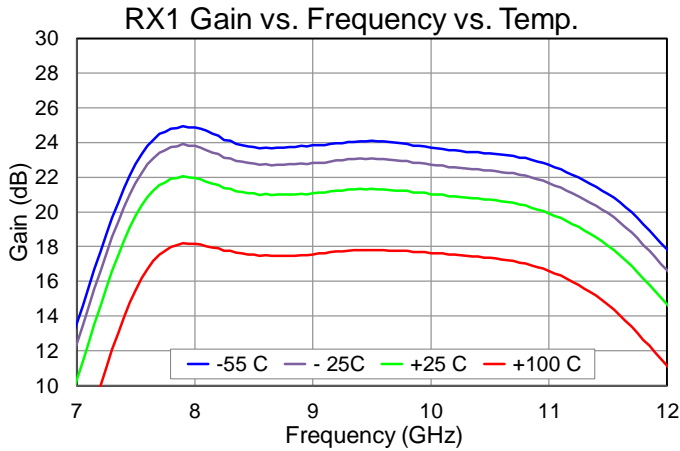

Performance Plots, Receive Channel

Test Conditions unless otherwise stated: RXVD = 10 V, RXIDQ = 30 mA, RXSW = -28 V, TXSW = 0 V, PA off, 25C
Data de-embedded to device reference plane, Port 1: Common Port, Port 2: RXOUT1, Port 3: RXOUT2

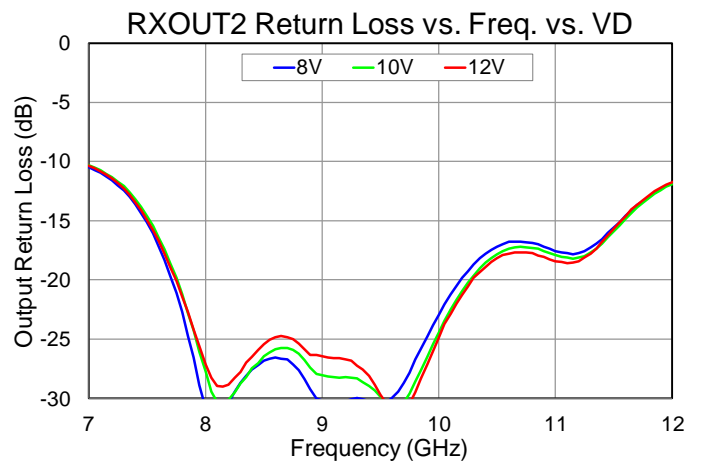
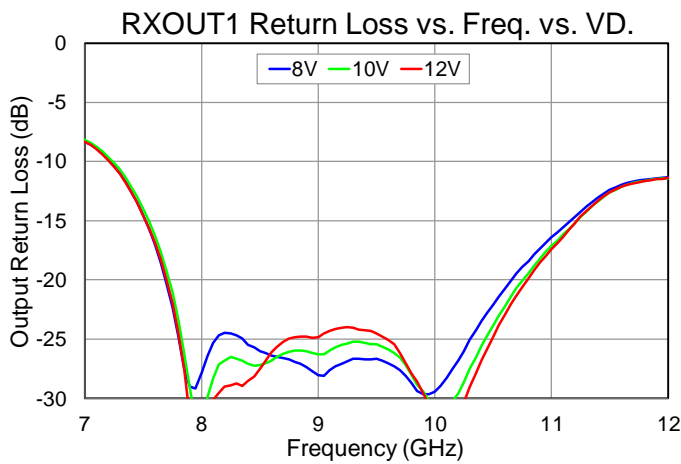
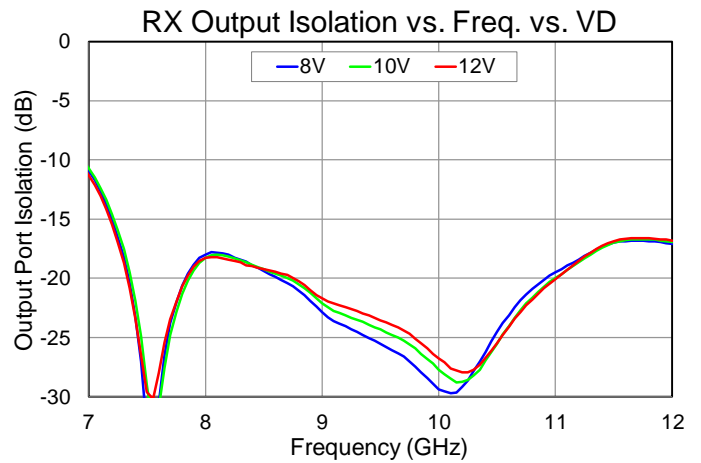
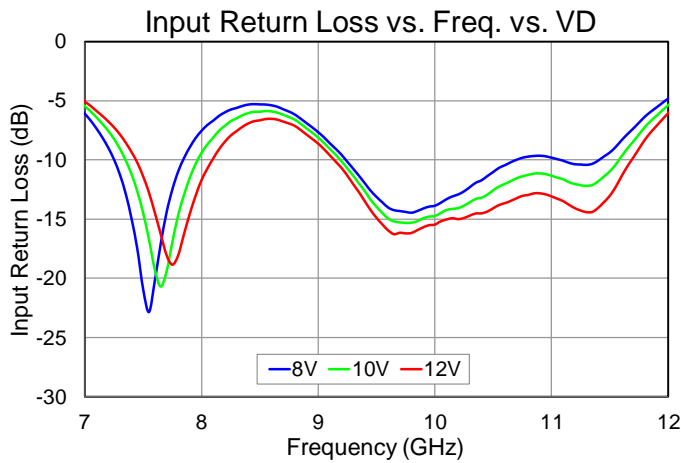
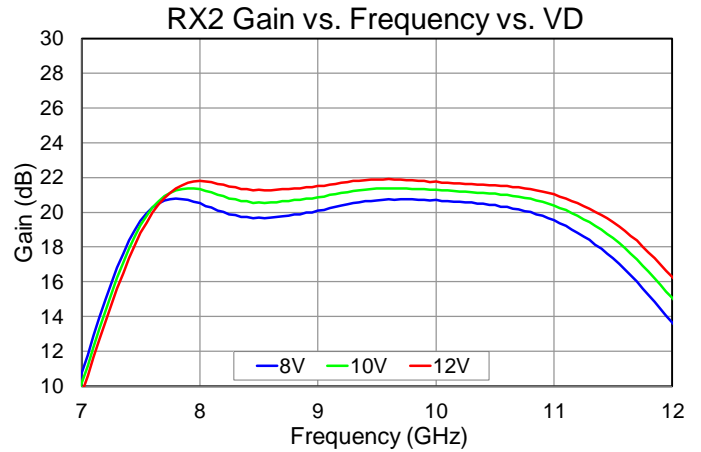
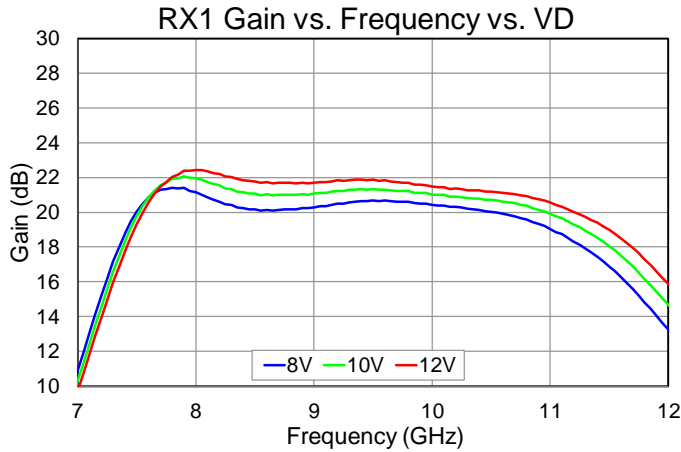

Performance Plots, Receive Channel

Test Conditions unless otherwise stated: VD = 10 V, RXIDQ = 30 mA, RXSW = -28 V, TXSW = 0 V, 10 MHz tone spacing, Pin = -20dBm, PA off. Data de-embedded to device reference plane, 25C

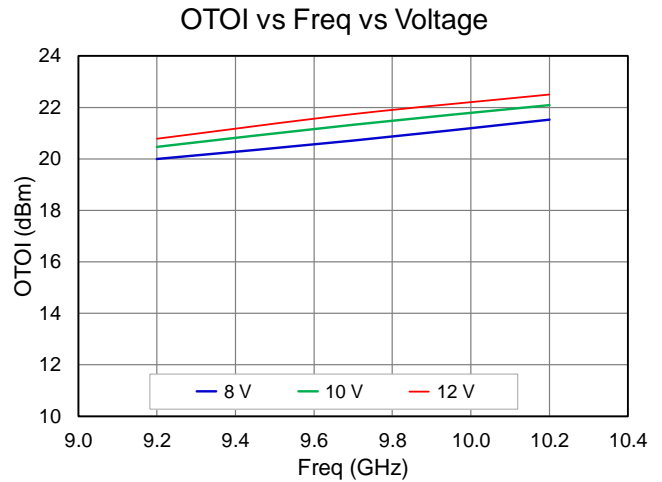
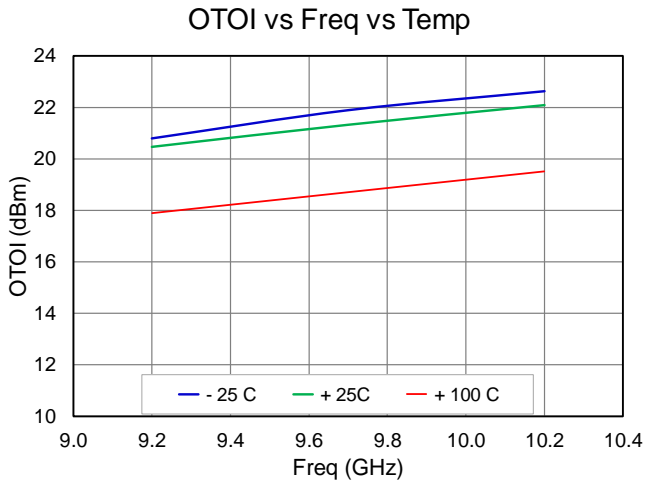
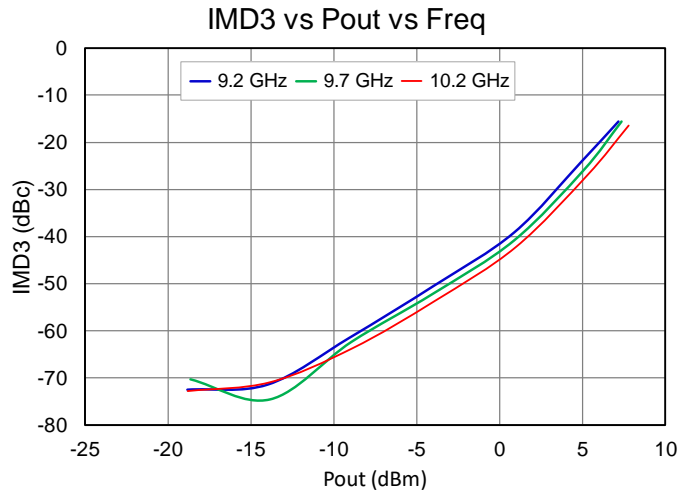
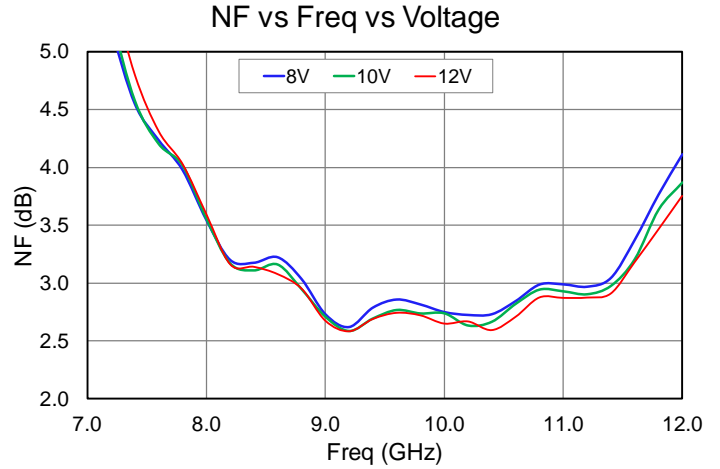
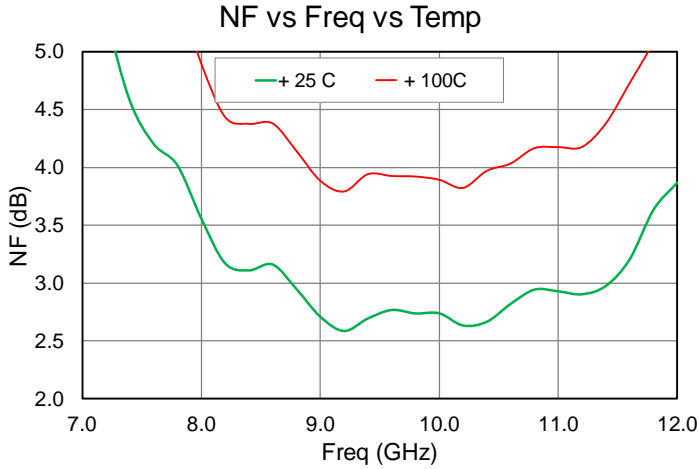

Performance Plots, Receive Channel

Test Conditions unless otherwise stated: $V_D = 10\text{ V}$, $R_{XIDQ} = 30\text{ mA}$, $P_{in} = 5\text{ dBm}$, $R_{XSW} = -28\text{ V}$, $T_{XSW} = 0\text{ V}$, PA off
Data de-embedded to device reference plane, 25C

RX Psat vs Freq vs Voltage

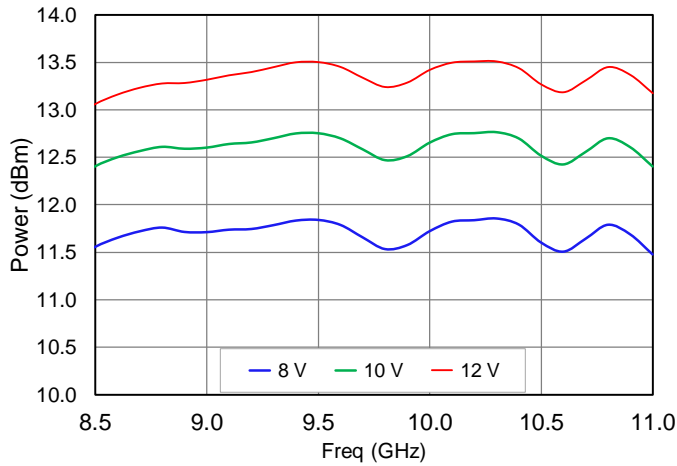

RX Psat vs Freq vs Temp

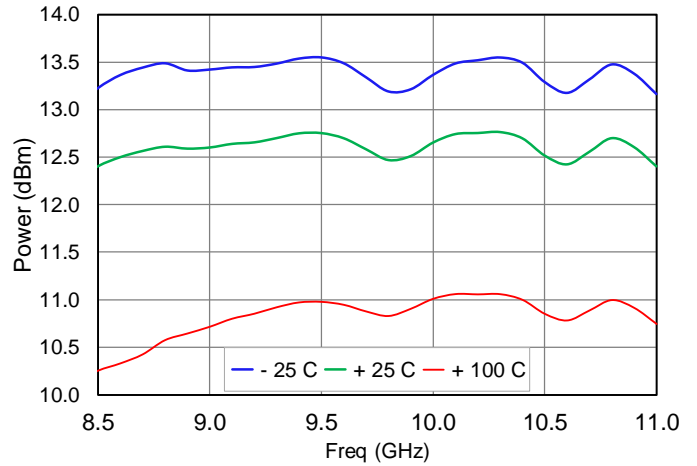

Output Power vs Pin vs Freq

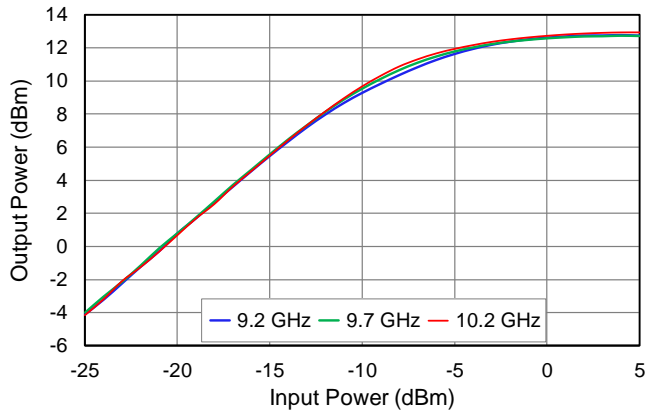

Power Gain vs Pin vs Freq

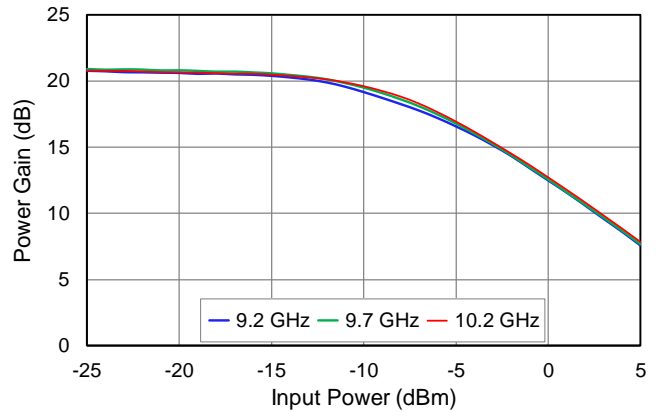

Drain Current vs Pin vs Freq

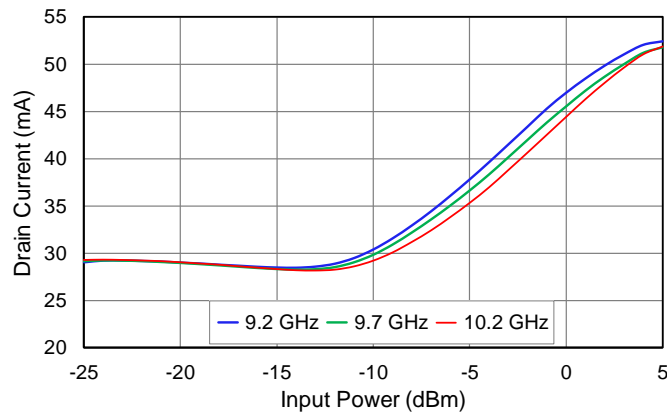

Performance Plots, Transmit Channel

Test Conditions unless otherwise stated: TXVD = 28 V, TXIDQ = 50 mA, TXVG fixed over temperature
RXSW = 0V, TXSW = -28 V, LNA off. Data de-embedded to device reference plane, 25C

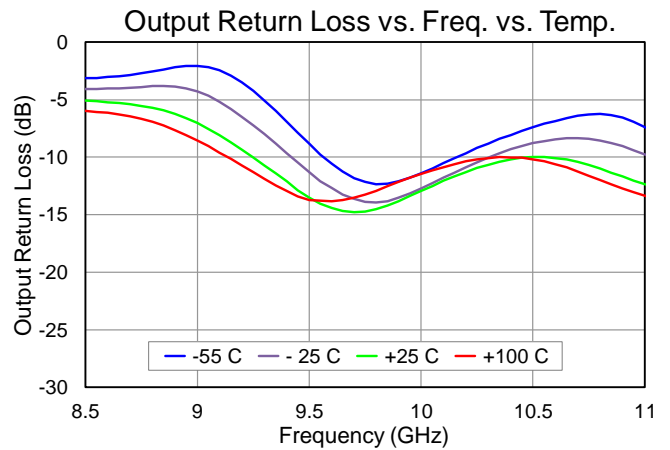
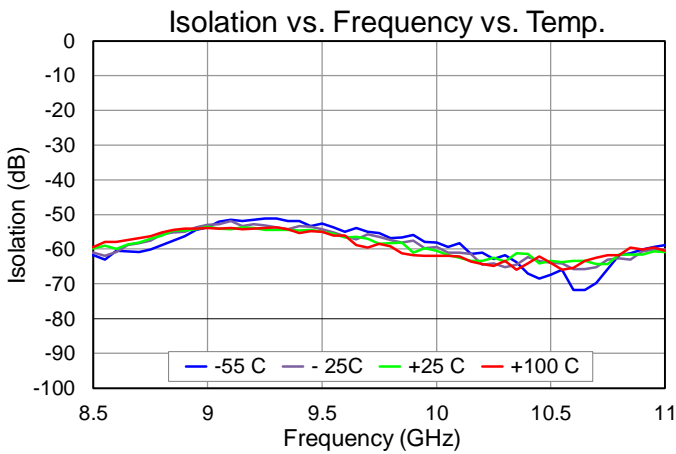
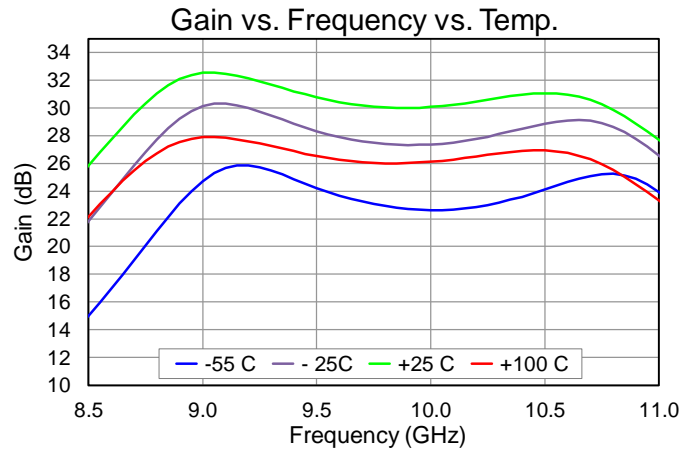
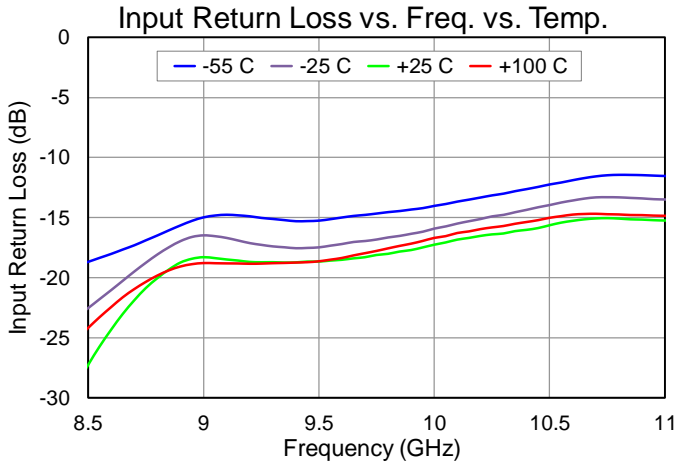

Performance Plots, Transmit Channel

Test Conditions unless otherwise stated: VD = 28 V, TXIDQ = 50 mA, TXVG fixed over temperature
RXSW = 0V, TXSW = -28 V, LNA off. Data de-embedded to device reference plane, 25C

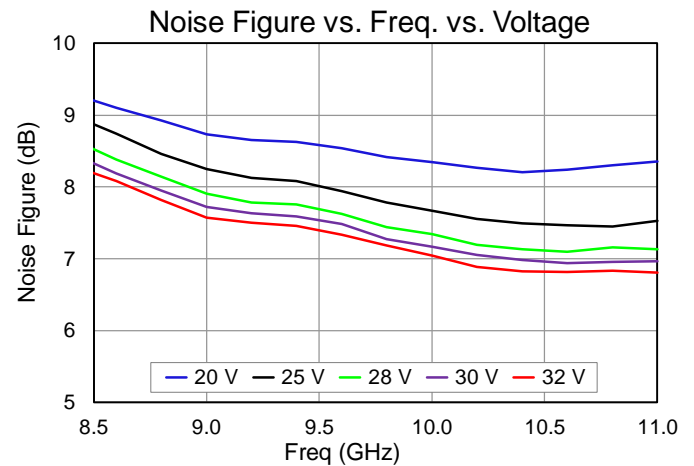
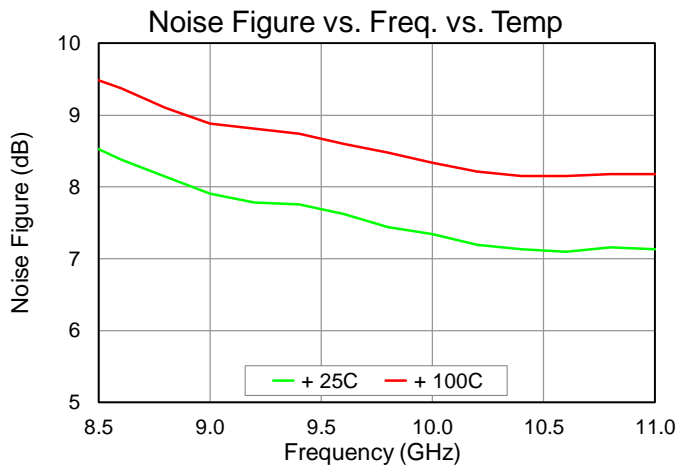
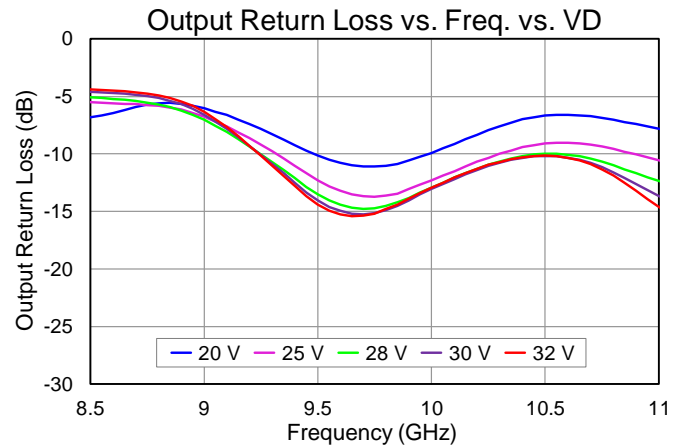
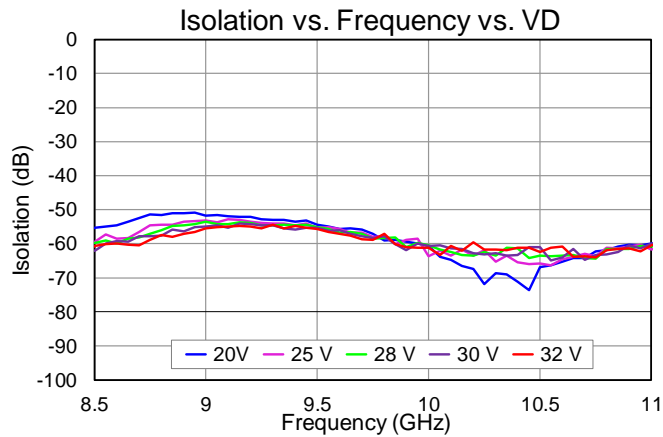
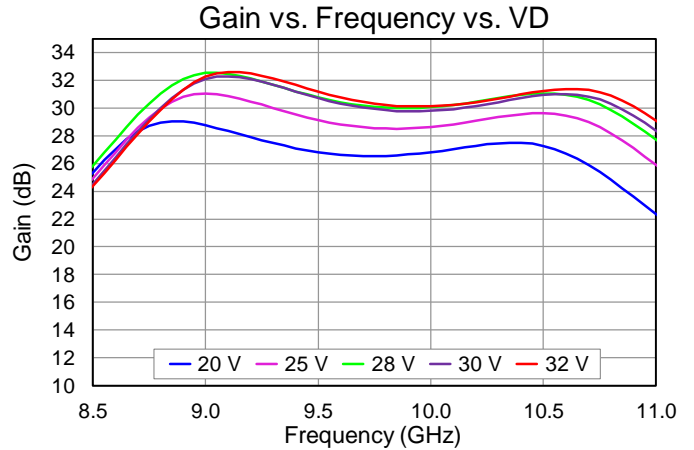
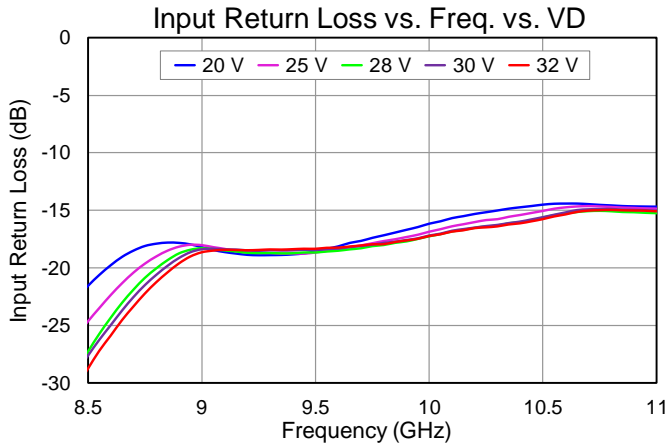

Performance Plots, Transmit Channel

Test Conditions unless otherwise stated: TXVD = 28 V, TXIDQ = 50 mA, TXVG fixed over temperature, RXSW = 0V
TXSW = -28 V, Pin = 13 dBm, PW = 200uS, DC = 10%, LNA off. Data de-embedded to device reference plane, 25C

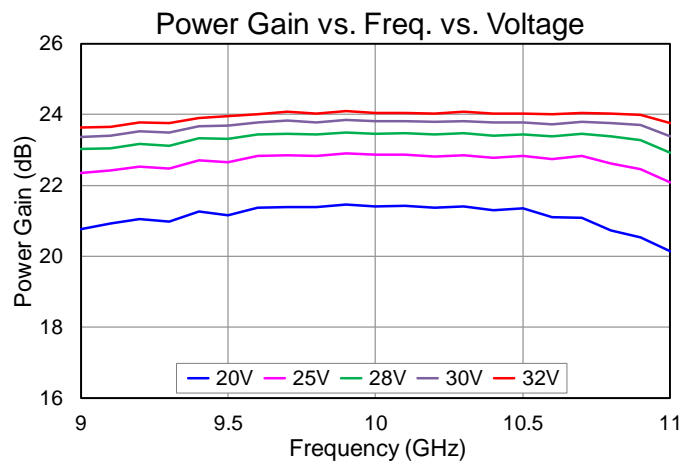
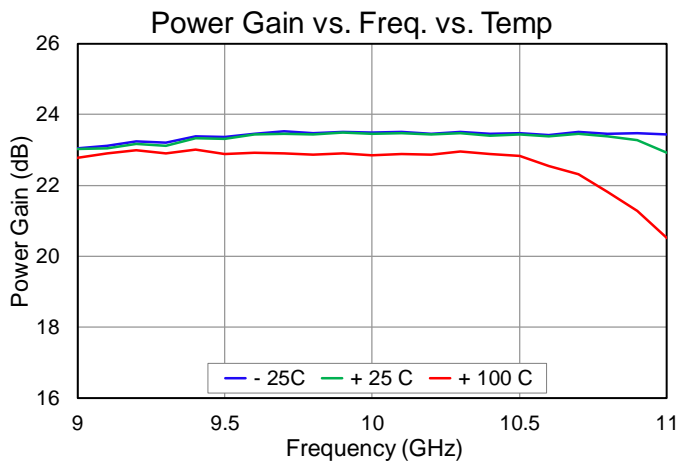
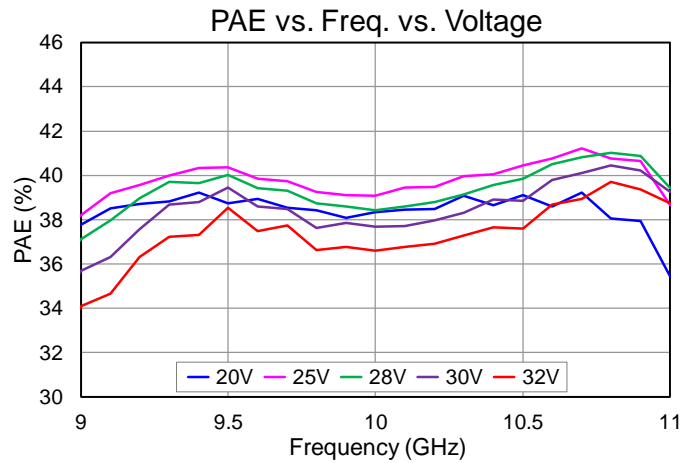
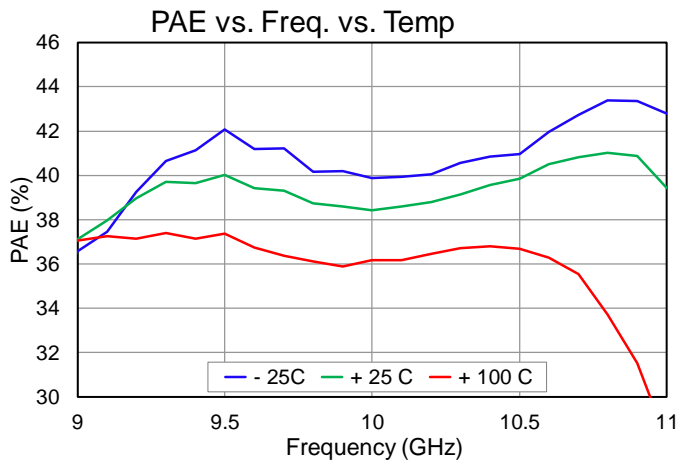
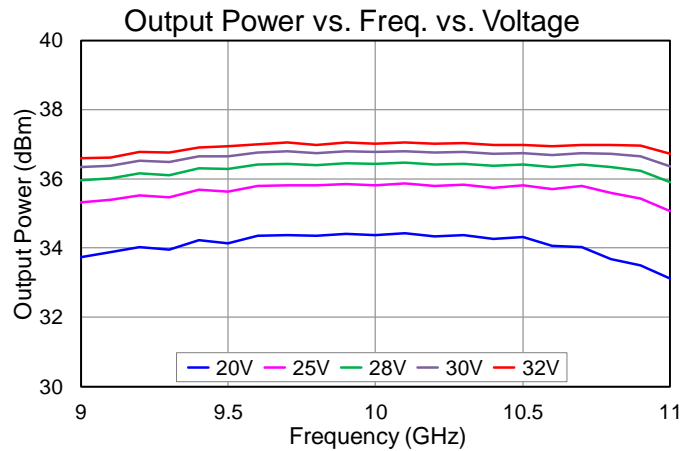
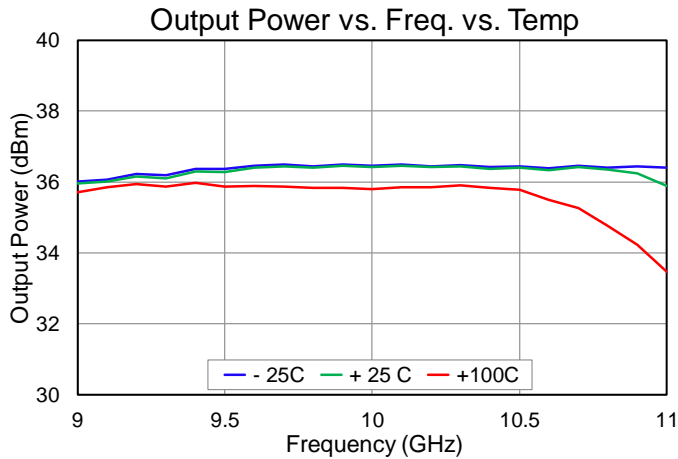

Performance Plots, Transmit Channel

Test Conditions unless otherwise stated: TXVD = 28 V, TXIDQ = 50 mA, RXSW = 0V, TXSW = -28 V
PW = 200 uS, DC = 10%, LNA off. Data de-embedded to device reference plane, 25C

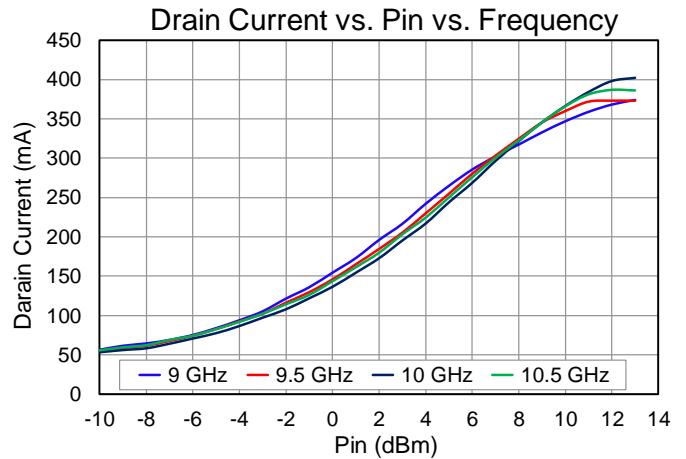
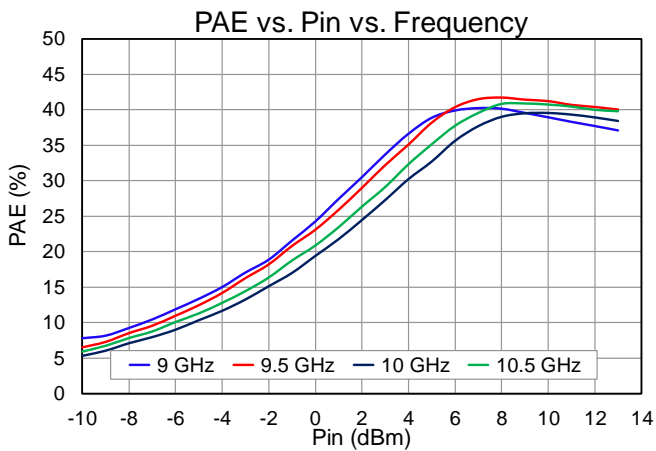
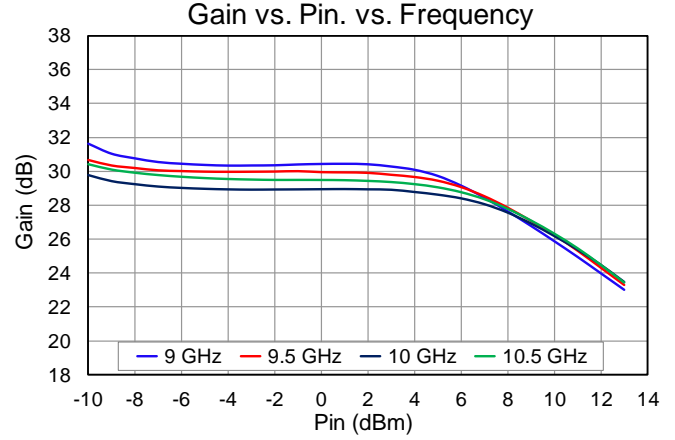
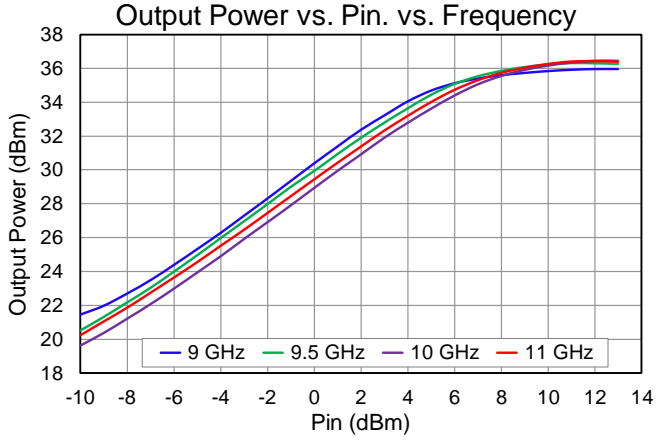

Performance Plots, Transmit Channel

Test Conditions unless otherwise stated: TXVD = 28 V, TXIDQ = 50 mA, TXVG fixed over temperature
RXSW = 0V, TXSW = -28 V, Freq: 10.2 GHz, LNA off. Data de-embedded to device reference plane, 25C

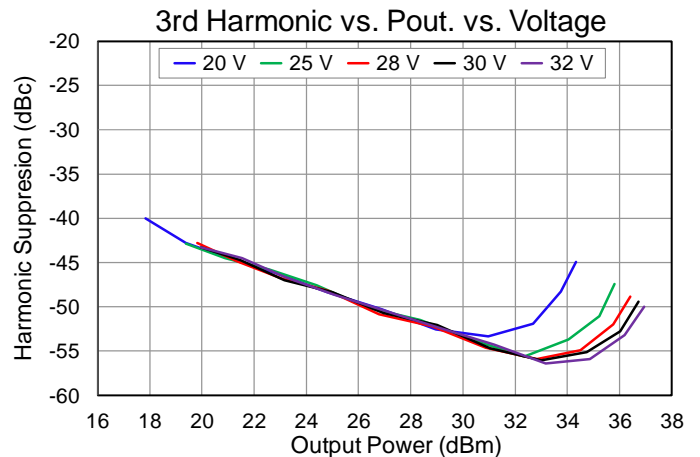
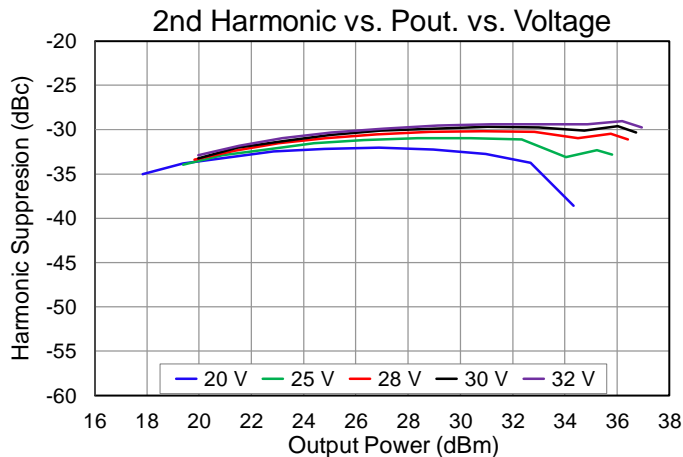
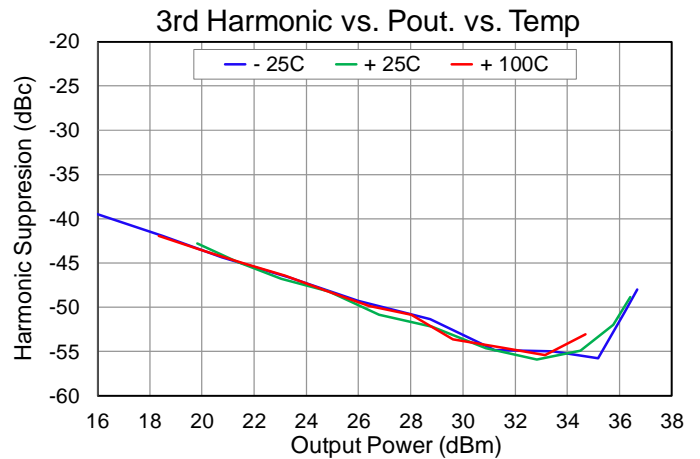
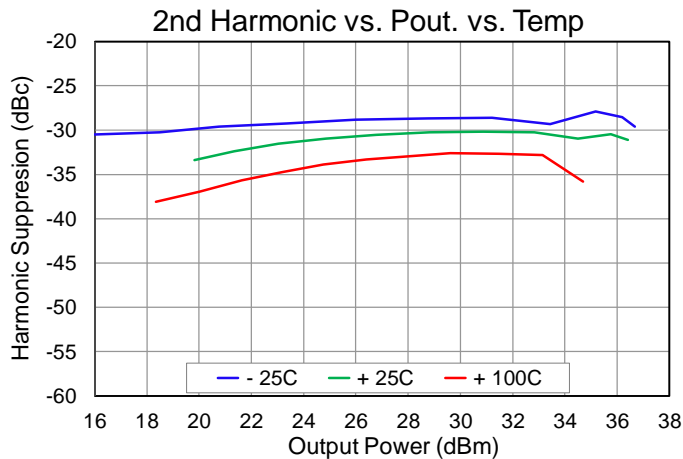
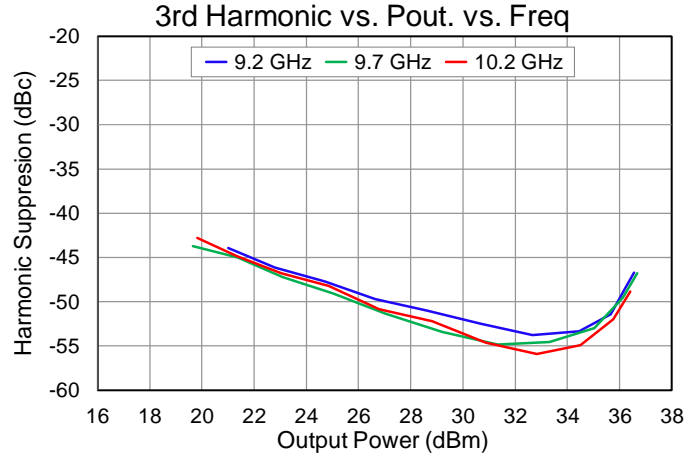
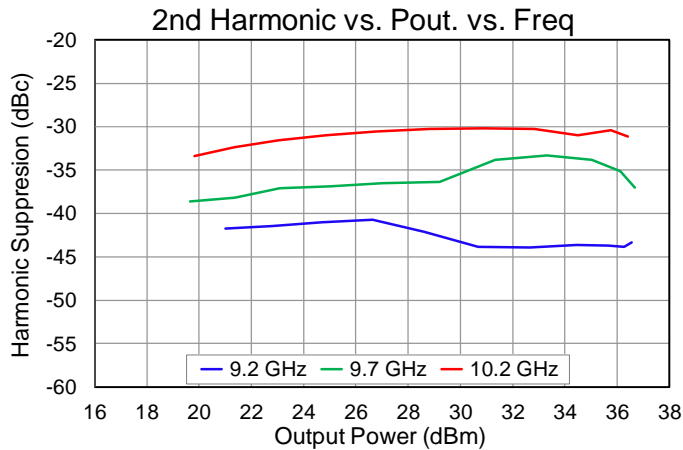

Application Circuit

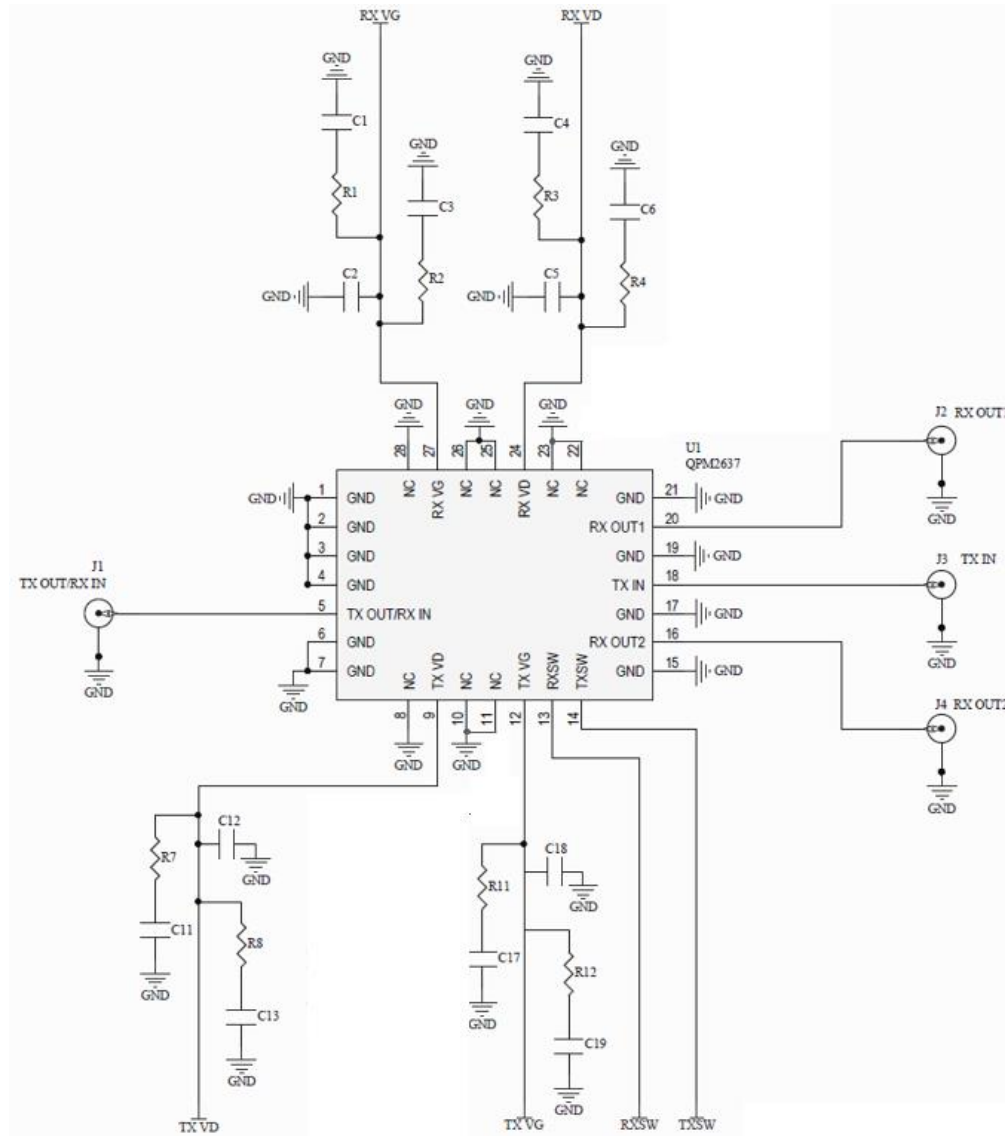

Bias-up Procedure

1. Set TXVD current limit to 600 mA, RXVD current limit to 60 mA, RXVG current limit to 10 mA, TXVG current limit to 100 mA, switch control current limit to 10 mA
2. Set RXVG and TXVG to -5 V (TXVG will draw ~50mA current)
3. Set TXSW = -28 V (or 0 V), RXSW = 0 V (or -28 V) for TX (RX) channel operation
4. Set RXVD = +10 V, TXVD = +28 V
5. Adjust TXVG, RXVG to achieve required drain current for TX and RX (-2.5 V Typical)
6. Apply RF signal

Bias-down Procedure

1. Turn off RF signal
2. Set RXVG, TXVG to -5 V
3. Set RXVD = 0 V, TXVD = 0 V
4. Turn off drain supply
5. Turn off TXSW, RXSW
6. Turn off gate supply

Mechanical Drawing & Pad Description

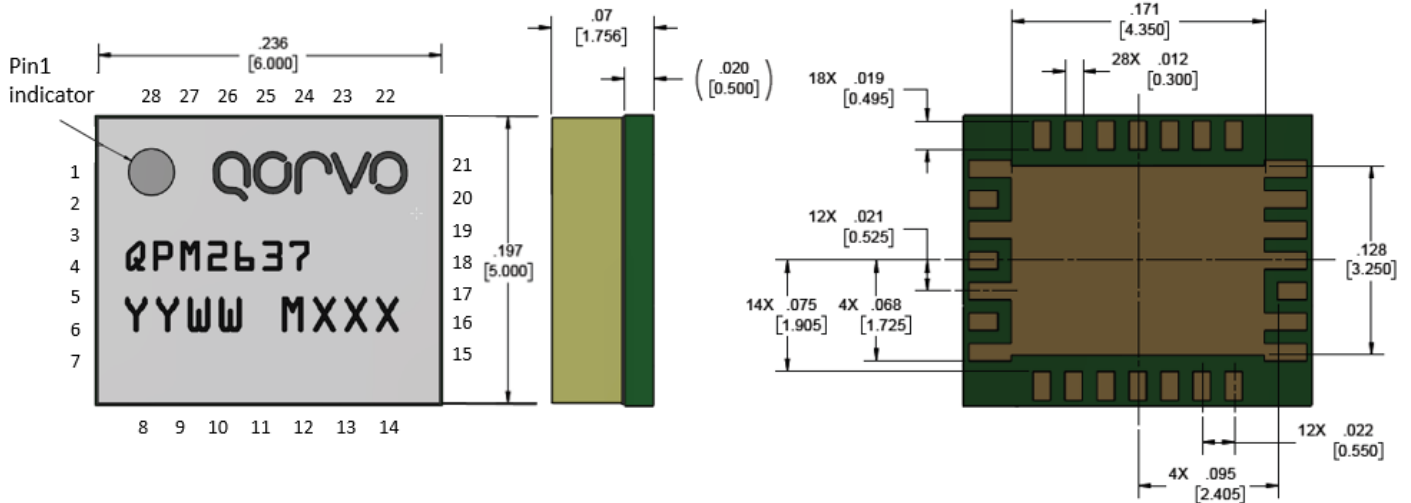

Dimensions in mm. Package lead finish: Ni / Au plating with minimum gold thickness of 0.1 um
 Part Marking: QPM2637: Part Number, YY = Part Assembly Year, WW = Part Assembly Week, MXXX = Batch ID

Pin Number	Label	Description
1, 2, 3, 4, 6, 7, 15, 17, 19, 21, Slug	GND	GROUND
5	ANT	Common Port to Antenna
9	TXVD	Transmit Drain Supply
12	TXVG	Transmit Gate Control
13	RXSW	Receive Switch Control
14	TXSW	Transmit Switch Control
16	RXOUT2	Receive Output 2
18	TXIN	Transmit Input
20	RXOUT1	Receive Output 1
24	RXVD	Receive Drain Supply
27	RXVG	Receive Gate Control
8, 10, 11, 22, 23, 25, 26, 28	N/C	No Internal Connections

Evaluation Board and Assembly

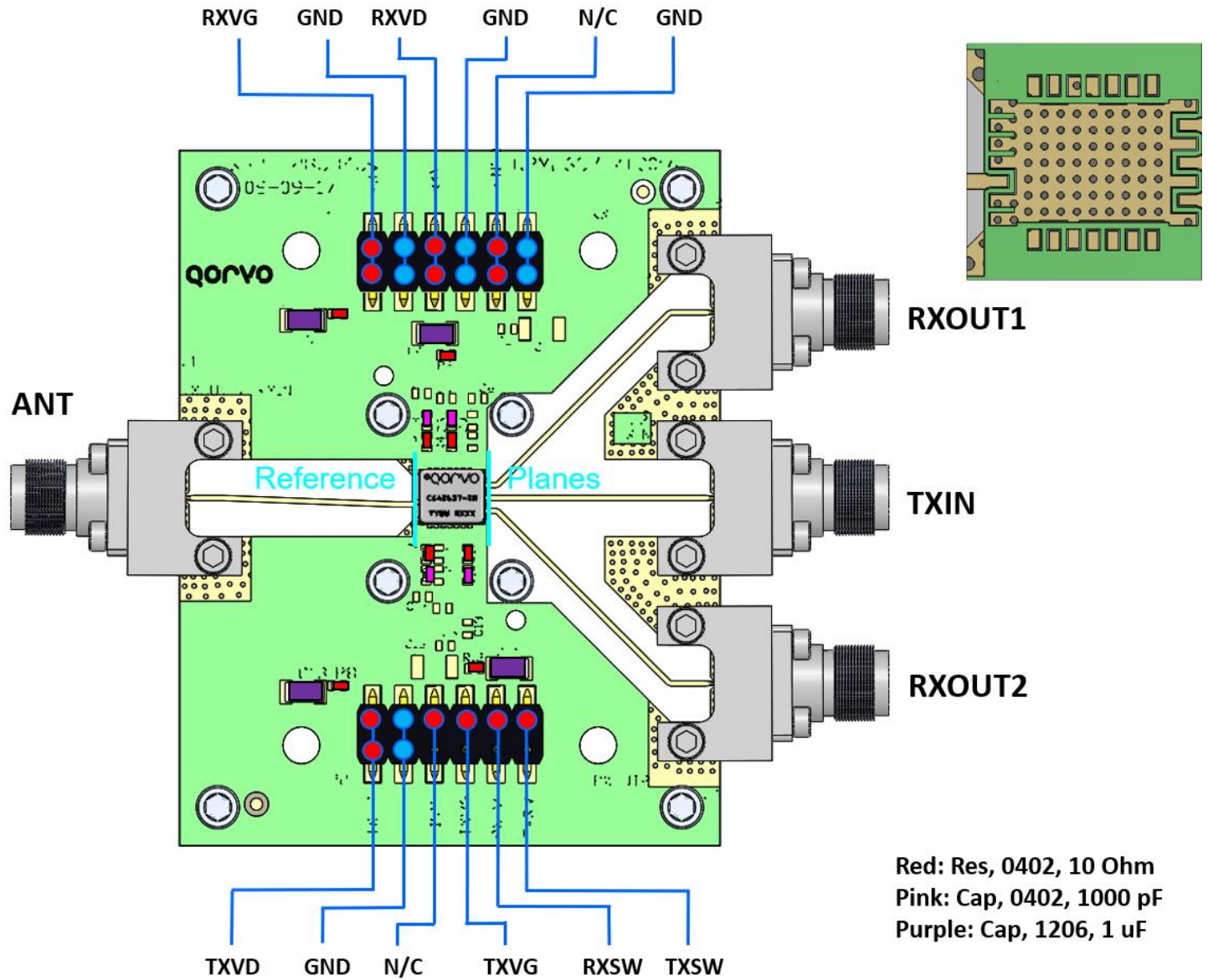

RF Layer is 0.008" thick Rogers Corp. RO4003C ($\epsilon_r = 3.35$). Metal layers are 0.5 oz. copper. The microstrip line at the connector interface is optimized for the Southwest Microwave end launch connector 1492-04A-5.

Ref. Des.	Component	Value	Manuf.	Part Number
C3, C6, C11, C17	SMT Cap.	CAP, 0402 1000pF +/-10% 50V 0402 X7R ROHS	Various	
C1, C4, C13, C19	SMT Cap.	CAP, 1206 1.0uF +/-10% 50V X7R ROHS	Various	
R1, R2, R3, R4, R7, R8, R11, R12	SMT Res.	RES, 0402 10 OHM, 5% 50V, ROHS	Various	

Thermal and Reliability Information

Parameter	Values	Units	Conditions
TX Channel, Thermal Resistance (θ_{JC}) ^(1,2)	6.92	°C/W	T _{BASE} = 100°C, TXVD = 28 V, TXIDQ =50 mA TXID_DRIVE = 376 mA, P _{IN} = 13 dBm, Freq = 10GHz, P _{DISS} = 6.60 W (PA only, LNA off)
Channel Temperature (T _{CH})	145.70	°C	
RX Channel, Thermal Resistance (θ_{JC}) ⁽¹⁾	12.37	°C/W	T _{BASE} = 100°C, RXVD = 10 V, RXIDQ =30 mA P _{DISS} = 0.3 W (LNA only, PA off)
Channel Temperature (T _{CH})	103.71	°C	

Notes:

- Thermal resistance is referenced to package backside.
- Transmit Channel, RF drive is under pulse drain supply condition, PW = 200 uS, DC = 10%, P_{DISS} and I_{D_DRIVE} are peak values.
- Refer to the following document: [GaN Device Channel Temperature, Thermal Resistance, and Reliability Estimates](#).

Assembly Notes

- Compatible with both lead-free (260°C peak reflow temp.) and tin/lead (245°C peak reflow temp.) soldering processes.
- This package is air-cavity and non-hermetic, and therefore cannot be subjected to aqueous washing. The use of no-clean solder to avoid washing after soldering is highly recommended.
- Solder rework not recommended.

Recommended Soldering Temperature Profile

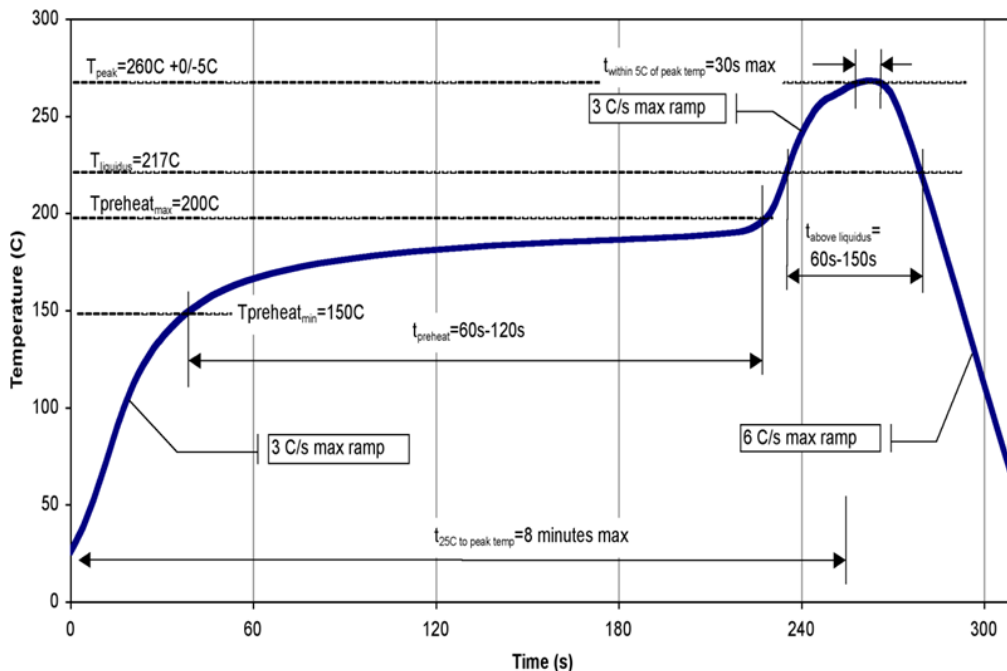

Tape and Reel Information

Standard T/R size = 250 pieces on a 7" reel.

Material		Cavity (mm)				Distance Between Centerline (mm)		Carrier Tape (mm)	Cover Carrier (mm)
Vendor	Vendor P/N	Length (A0)	Width (B0)	Depth (K0)	Pitch (P1)	Length direction (P2)	Width Direction (F)	Width (W)	Width (W)
Advantek	BCA389-A	5.30	6.30	2.1	8.0	2.00	5.50	12.0	9.20

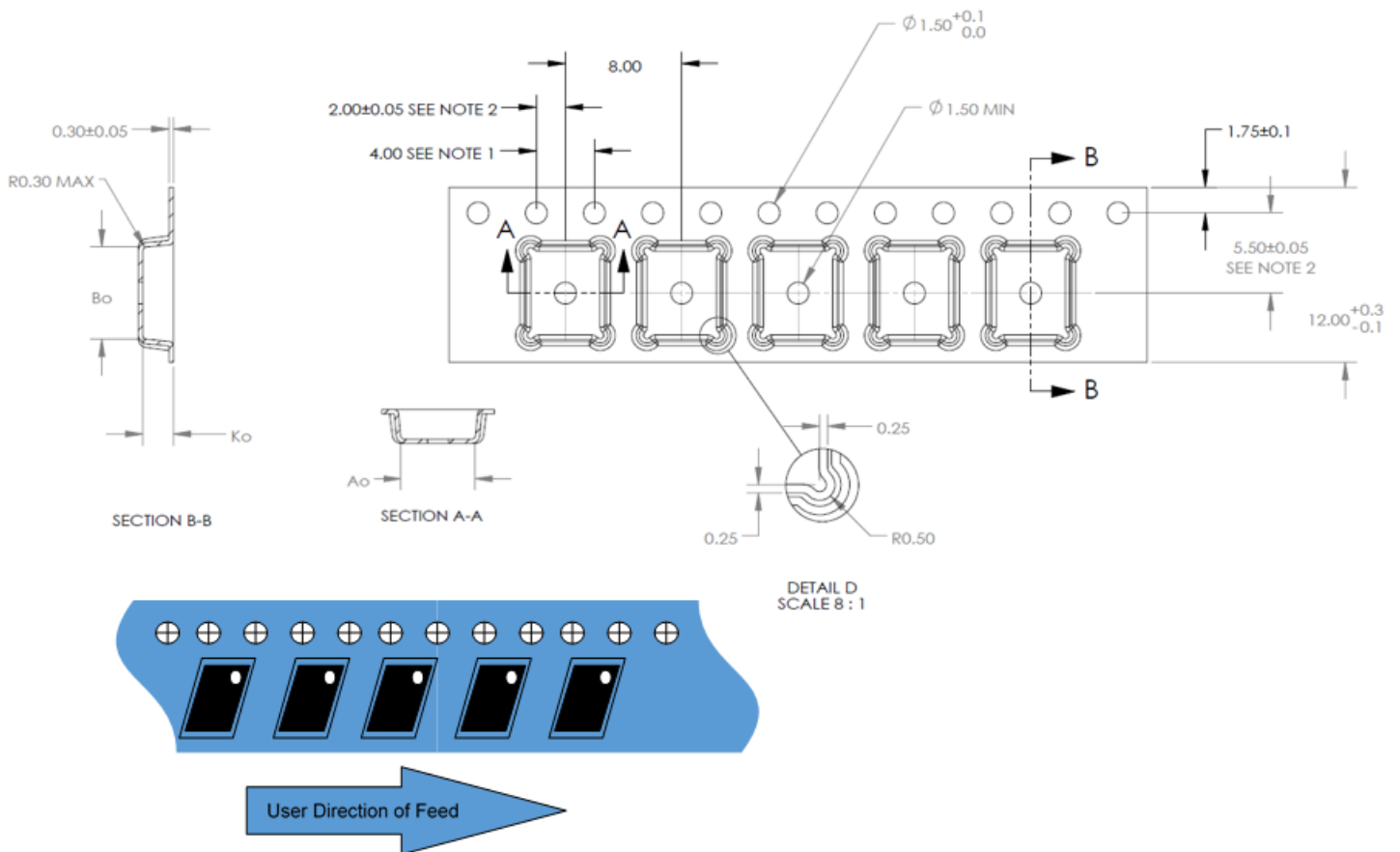

Handling Precautions

Parameter	Rating	Standard
ESD – Human Body Model (HBM)	TBD	ESDA / JEDEC JS-001-2012
ESD – Charged Device Model (CDM)	TBD	ESDA / JEDEC JS-002-2014
MSL – Convection Reflow 260 °C	TBD	JEDEC standard IPC/JEDEC J-STD-020



Caution!
ESD-Sensitive Device

RoHS Compliance

This product is compliant with the 2011/65/EU RoHS directive (Restrictions on the Use of Certain Hazardous Substances in Electrical and Electronic Equipment), as amended by Directive 2015/863/EU.

This product also has the following attributes:

- Lead Free
- Antimony Free
- TBBP-A (C₁₅H₁₂Br₄O₂) Free
- PFOS Free

Contact Information

For the latest specifications, additional product information, worldwide sales and distribution locations:

Tel: 1-844-890-8163

Web: www.qorvo.com

Email: customer.support@qorvo.com

Important Notice

The information contained in this Data Sheet and any associated documents (“Data Sheet Information”) is believed to be reliable; however, Qorvo makes no warranties regarding the Data Sheet Information and assumes no responsibility or liability whatsoever for the use of said information. All Data Sheet Information is subject to change without notice. Customers should obtain and verify the latest relevant Data Sheet Information before placing orders for Qorvo® products. Data Sheet Information or the use thereof does not grant, explicitly, implicitly or otherwise any rights or licenses to any third party with respect to patents or any other intellectual property whether with regard to such Data Sheet Information itself or anything described by such information.

DATA SHEET INFORMATION DOES NOT CONSTITUTE A WARRANTY WITH RESPECT TO THE PRODUCTS DESCRIBED HEREIN, AND QORVO HEREBY DISCLAIMS ANY AND ALL WARRANTIES WITH RESPECT TO SUCH PRODUCTS WHETHER EXPRESS OR IMPLIED BY LAW, COURSE OF DEALING, COURSE OF PERFORMANCE, USAGE OF TRADE OR OTHERWISE, INCLUDING THE IMPLIED WARRANTIES OF MERCHANTABILITY AND FITNESS FOR A PARTICULAR PURPOSE. Without limiting the generality of the foregoing, Qorvo® products are not warranted or authorized for use as critical components in medical, life-saving, or life-sustaining applications, or other applications where a failure would reasonably be expected to cause severe personal injury or death. Applications described in the Data Sheet Information are for illustrative purposes only. Customers are responsible for validating that a particular product described in the Data Sheet Information is suitable for use in a particular application.

© 2021 Qorvo US, Inc. All rights reserved. This document is subject to copyright laws in various jurisdictions worldwide and may not be reproduced or distributed, in whole or in part, without the express written consent of Qorvo US, Inc. | QORVO® is a registered trademark of Qorvo US, Inc.

X-ON Electronics

Largest Supplier of Electrical and Electronic Components

Click to view similar products for [RF Front End](#) category:

Click to view products by [Qorvo](#) manufacturer:

Other Similar products are found below :

[SE2622L-R](#) [BGM1032N7E6327XUSA1](#) [LX5586LL](#) [LX5586HLL](#) [LX5586ALL](#) [SKY66111-21](#) [SKY65728-11](#) [SKY68000-31](#) [SKY85308-11](#)
[SKY85302-11](#) [SKY85300-21](#) [ADTR1107ACCZ](#) [LMP91051MTX/NOPB](#) [SE5501L-R](#) [QPF4519SR](#) [SE5503A-R](#) [ADA8282WBCPZ](#)
[ADRF5545ABCPZN](#) [ADRF5545ABCPZN-R7](#) [AD8283WBCPZ](#) [AD8284WCSVZ](#) [ADRF5547BCPZN](#) [ADRF5547BCPZN-R7](#)
[ADRF5549BCPZN](#) [ADRF5549BCPZN-R7](#) [HV7350K6-G](#) [SE5516A-R](#) [MCP2030-I/SL](#) [MAX2009ETI+](#) [MAX2078CTK+](#) [MAX2335ETI+](#)
[MAX2678GTB/V+T](#) [MD2131K7-G](#) [MD2134K7-G](#) [RFFM4554SR](#) [RFFM4554TR7](#) [RFFM8504SR](#) [RFFM8511SR](#) [RFFM4552TR7](#)
[RFFM4503TR7](#) [RFFM6903TR13](#) [HV7351K6-G](#) [MCP2035-I/ST](#) [SE2614BT-R](#) [SE2438T-R](#) [SST12LF02-QXCE](#) [SST12LF09-Q3CE](#)
[RFX2401C](#) [RFX2402E](#) [SKY85201-11](#)