

Product Overview

QPQ1029 is a high performance, Bulk Acoustic Wave (BAW) dual band filter module designed for Band 1 Uplink & Band 3 Uplink

The QPQ1029 provides low insertion loss and very high rejection, making it an ideal choice for small cell. This diplexer is housed in a compact ROHS compliant 3x3 mm surface mount package.

The QPQ1029 is part of Qorvo's extensive portfolio of RF BAW and SAW filters.

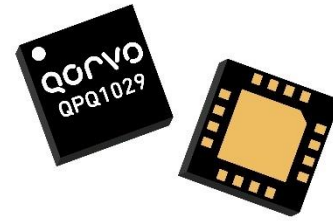

16 Pad 3 x 3 mm SMT Package

Functional Block Diagram

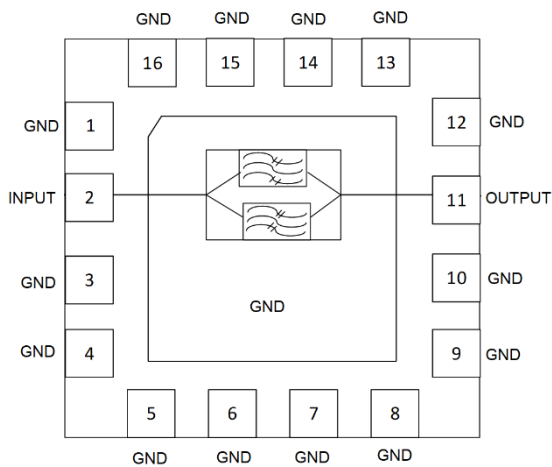

Top View

Pin Configuration

Pin No.	Label
2	INPUT
11	OUTPUT
1,3,4,5,6,7,8,9,10,12,13,14,15,16, Back Side Center Pad	GND

Key Features

- 60 MHz Bandwidth for Band 1 Uplink
- 75 MHz Bandwidth for Band 3 Uplink
- Low Loss and High Attenuation
- +29dBm Power Handling for Small Cell Application
- Single Ended Operation to 50 Ω
- No External Matching Required
- RoHS Compliant, Pb-Free



Applications

- B3 Uplink and B1 Uplink
- Base Station Infrastructure
- Small Cells
- Repeaters
- LTE Dongles
- General Purpose Wireless

Ordering Information

Part No.	Description
QPQ1029TR7	2,500 pieces on a 7" reel (standard)
QPQ1029EVB	Evaluation Board

Absolute Maximum Ratings ⁽¹⁾

Parameter	Rating
Storage Temperature	-40 to +125 °C
Operating Temperature ⁽²⁾	-40 to +95 °C

Notes:

1. Operation of this device outside of the parameter ranges may cause permanent damage.
2. Device will be functional, but is not guaranteed to meet electrical specifications

Minimum Lifetime Rating

Conditions	Rating
+29dBm Apply to Pin 2 Input, +95°C, LTE 5 MHz, 16 QAM, PAR 8dB, Frequency 1785MHz or 1980 MHz	>87,600 hours

Electrical Specifications ^{(1) (2) (3)}

Test Conditions unless otherwise noted= -20°C to +85°C

Parameter	Conditions	Min	Typ ⁽⁴⁾	Max	Units
Passband Frequency, B3UL		1710	-	1785	MHz
Passband Frequency, B1UL		1920	-	1980	MHz
Integrated Insertion Loss ⁽⁵⁾ B3UL	1710 MHz – 1785 MHz	-	2.5	3.5	dB
Integrated Insertion Loss ⁽⁵⁾ B1UL	1920 MHz – 1980 MHz	-	2.1	2.7	dB
Amplitude Ripple ⁽⁶⁾ B3UL	1710 MHz – 1785 MHz	-	0.8	2.4	dB
Amplitude Ripple ⁽⁶⁾ B1UL	1920 MHz – 1980 MHz	-	0.6	1.6	dB
Input VSWR B3UL	1710 MHz – 1785 MHz	-	1.6:1	2.0:1	ratio
Input VSWR B1UL	1920 MHz – 1980 MHz	-	1.4:1	2.0:1	ratio
Output VSWR B3UL	1710 MHz – 1785 MHz	-	1.6:1	2.0:1	ratio
Output VSWR B1UL	1920 MHz – 1980 MHz	-	1.5:1	2.0:1	ratio
Input Return Loss B3UL ⁽⁸⁾	1710 MHz – 1785 MHz	9.5	13	-	dB
Input Return Loss B1UL ⁽⁸⁾	1920 MHz – 1980 MHz	9.5	16	-	dB
Output Return Loss B3UL ⁽⁸⁾	1710 MHz – 1785 MHz	9.5	12	-	dB
Output Return Loss B1UL ⁽⁸⁾	1920 MHz – 1980 MHz	9.5	14	-	dB
Group Delay Variation B3UL ⁽⁷⁾	1710 MHz – 1785 MHz	-	8	24	ns
Group Delay Variation B1UL ⁽⁷⁾	1920 MHz – 1980 MHz	-	5	20	ns

Notes:

1. All specifications are based on the Qorvo test circuit shown on page 11
2. In production, devices are tested at room temperature with guard-banded specifications to ensure electrical compliance over temperature
3. Electrical margin has been designed into account for the variations due to temperature drift and manufacturing tolerances
4. Typical values are based on average measurements at room temperature of 25°C
5. Insertion Loss is Integrated over any 5MHz bandwidth within the defined frequency band
6. This is defined as the worst difference between a peak and adjacent valley over any 5 MHz window within the frequency band
7. Measured over any 5 MHz window within the frequency band
8. This Parameter is guaranteed by design, and will not be tested in production

Electrical Specifications ⁽¹⁾ ⁽²⁾ ⁽³⁾

Test Conditions unless otherwise noted= -20°C to +85°C

Parameter	Conditions	Min	Typ ⁽⁴⁾	Max	Units
Attenuation ⁽⁶⁾	0-729 MHz	31	50	-	dB
	729-960 MHz	42	45	-	
	960-1475 MHz	31	40	-	
	1475-1559 MHz	33	35	-	
	1559-1690 MHz ⁽⁵⁾	10	30	-	
	1805-1880 MHz ⁽⁵⁾	45	49	-	
	2025-2110 MHz	26	26	-	
	2110-2170 MHz ⁽⁵⁾	45	53	-	
	2170-2288 MHz	26	52	-	
	2300-2400 MHz	45	49	-	
	2400-2690 MHz	35	45	-	
	2690-3400 MHz	21	44	-	
	3400-3800 MHz	47	56	-	
	3800-4600 MHz	26	36	-	
	4600-5000 MHz	30	39	-	
5000-8000 MHz	11	27	-		
8000-12750 MHz ⁽¹¹⁾	11	26	-		
Load/Source Impedance ⁽⁷⁾		-	50	-	Ω
PIM5 ⁽⁸⁾	IMD5-H ⁽⁹⁾ at Output P2 (B1UL)	-	-117	-	dBm
	IMD5-L ⁽¹⁰⁾ at Output P2 (B3UL)	-	-112	-	dBm

- Notes:
1. All specifications are based on the Qorvo test circuit shown on page 11
 2. In production, devices are tested at room temperature with guard-banded specifications to ensure electrical compliance over temperature.
 3. Electrical margin has been designed into account for the variations due to temperature drift and manufacturing tolerances
 4. Typical values are based on average measurements at room temperature of 25°C
 5. Integrated attenuation over any 5 MHz bandwidth within the specified frequency range
 6. Relative to zero dB
 7. This is the optimum impedance in order to achieve the performance shown.
 8. With 2 tones, F1 and F2, +23dBm/tone applied to INPUT P1. The F1 and F2 are selected from 1805 to 1880 MHz to have the IMD5 in B1 UL or B3 UL frequency range. The noise floor of the measurement system is -140 dBm. The PIM is guaranteed by design and not tested in production.
 9. IMD5-H (3*F2-2*F1) at Band 1 UL frequency range
 10. IMD5-L (3*F1-2*F2) at Band 3 UL frequency range
 11. This attenuation is guaranteed by design, and will not be tested in production

Electrical Specifications ^{(1) (2) (3)}

Test Conditions unless otherwise noted= -40°C to +95°C

Parameter	Conditions	Min	Typ ⁽⁴⁾	Max	Units
Passband Frequency, B3UL		1710	-	1785	MHz
Passband Frequency, B1UL		1920	-	1980	MHz
Integrated Insertion Loss ⁽⁵⁾ B3UL	1710 MHz – 1785 MHz	-	2.5	3.8	dB
Integrated Insertion Loss ⁽⁵⁾ B1UL	1920 MHz – 1980 MHz	-	2.1	2.9	dB
Amplitude Ripple ⁽⁶⁾ B3UL	1710 MHz – 1785 MHz	-	0.8	2.5	dB
Amplitude Ripple ⁽⁶⁾ B1UL	1920 MHz – 1980 MHz	-	0.6	1.8	dB
Input VSWR B3UL	1710 MHz – 1785 MHz	-	1.6:1	2.1:1	ratio
Input VSWR B1UL	1920 MHz – 1980 MHz	-	1.4:1	2.1:1	ratio
Output VSWR B3UL	1710 MHz – 1785 MHz	-	1.6:1	2.1:1	ratio
Output VSWR B1UL	1920 MHz – 1980 MHz	-	1.5:1	2.1:1	ratio
Input Return Loss B3UL ⁽⁸⁾	1710 MHz – 1785 MHz	9.0	13	-	dB
Input Return Loss B1UL ⁽⁸⁾	1920 MHz – 1980 MHz	9.0	16	-	dB
Output Return Loss B3UL ⁽⁸⁾	1710 MHz – 1785 MHz	9.0	12	-	dB
Output Return Loss B1UL ⁽⁸⁾	1920 MHz – 1980 MHz	9.0	14	-	dB
Group Delay Variation B3UL ⁽⁷⁾	1710 MHz – 1785 MHz		8	26	ns
Group Delay Variation B1UL ⁽⁷⁾	1920 MHz – 1980 MHz		5	22	ns

Notes:

1. All specifications are based on the Qorvo test circuit shown on page 11.
2. In production, devices will be tested at room temperature with guard-banded specifications to ensure electrical compliance over temperature.
3. Electrical margin has been designed into account for the variations due to temperature drift and manufacturing tolerances
4. Typical values are based on average measurements at room temperature of 25°C
5. Insertion Loss is Integrated over any 5MHz bandwidth within defined frequency band
6. This is defined as the worst difference between a peak and adjacent valley within any 5 MHz window within the frequency band
7. Measured over any 5 MHz window within the frequency band
8. This Parameter is guaranteed by design, and will not be tested in production

De-Embedded Electrical Specifications ⁽¹⁾ ⁽²⁾ ⁽³⁾

Test Conditions unless otherwise noted= -40°C to +95°C

Parameter	Conditions	Min	Typ. ⁽⁴⁾	Max	Units
Attenuation ⁽⁶⁾	0-729 MHz	31	50	-	dB
	729-960 MHz	42	45	-	
	960-1475 MHz	31	40	-	
	1475-1559 MHz	33	35	-	
	1559-1690 MHz ⁽⁵⁾	7	30	-	
	1805-1880 MHz ⁽⁵⁾	43	49	-	
	2025-2110 MHz	26	26	-	
	2110-2170 MHz ⁽⁵⁾⁽¹¹⁾	45	53	-	
	2170-2288 MHz	26	52	-	
	2300-2400 MHz	45	49	-	
	2400-2690 MHz	35	45	-	
	2690-3400 MHz	21	44	-	
	3400-3800 MHz	47	56	-	
	3800-4600 MHz	26	36	-	
	4600-5000 MHz	30	39	-	
5000-8000 MHz	11	27	-		
8000-12750 MHz ⁽¹¹⁾	11	26	-		
Load/Source Impedance ⁽⁶⁾		-	50	-	Ω
PIM5 ⁽⁸⁾	IMD5-H ⁽⁹⁾ at Output P2 (B1UL)	-	-117	-	dBm
	IMD5-L ⁽¹⁰⁾ at Output P2 (B3UL)	-	-112	-	dBm

Notes:

1. All specifications are based on the Qorvo test circuit shown on page 11.
2. In production, devices will be tested at room temperature with guard-banded specifications to ensure electrical compliance over temperature.
3. Electrical margin has been built into the design to account for the variations due to temperature drift and manufacturing tolerances
4. Typical values are based on average measurements at room temperature of 25°C
5. Integrated Rejection over 5 MHz bandwidth.
6. Relative to zero dB.
7. This is the optimum impedance in order to achieve the performance shown.
8. With 2 Tones, F1 and F2, +23dBm/tone applied to INPUT P1. F1 and F2 are selected from 1805 to 1880 MHz to have IMD5 in B1 UL or B3 UL frequency range. The noise floor of the measurement system is -140 dBm. PIM is guaranteed by design, and not tested in production.
9. IMD5-H (3*F2-2*F1) in Band 1 UL frequency range
10. IMD5-L (3*F1-2*F2) in Band 3 UL frequency range
11. This attenuation is guaranteed by design, and will not be tested in production

De-embedded Performance Plots – Band 3

Test conditions unless otherwise noted: Temp.=+25 °C

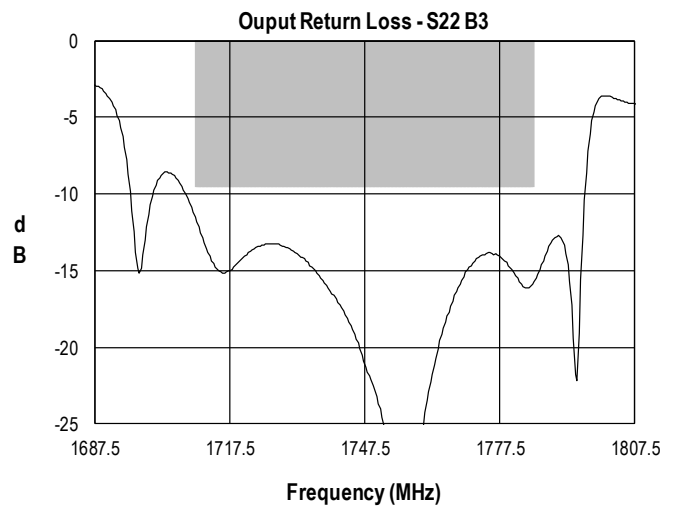
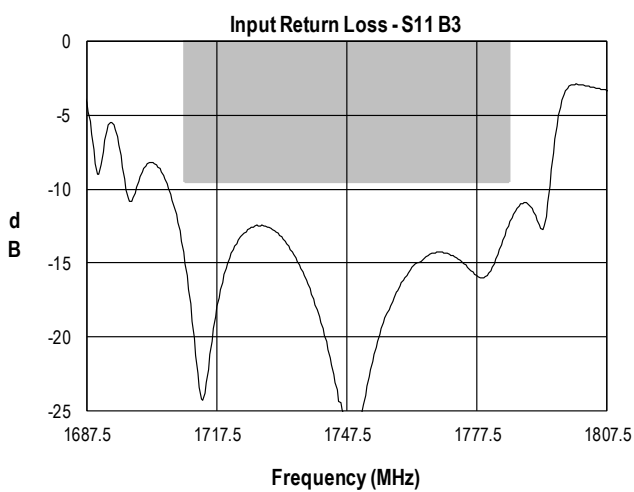
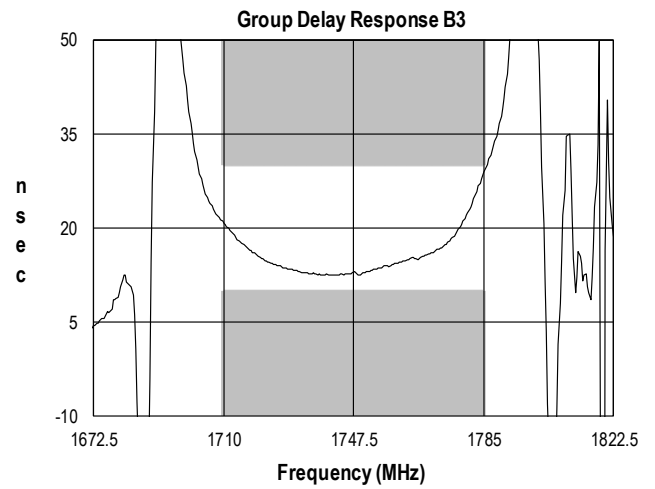
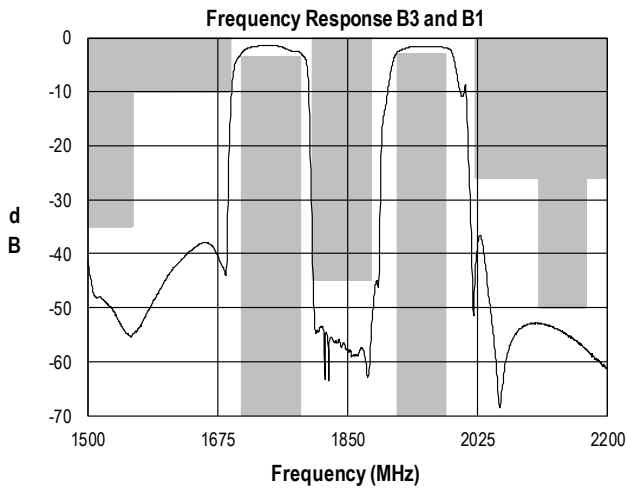
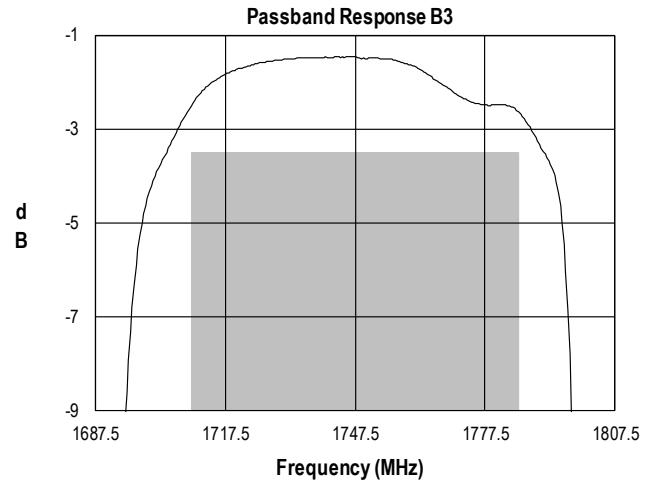
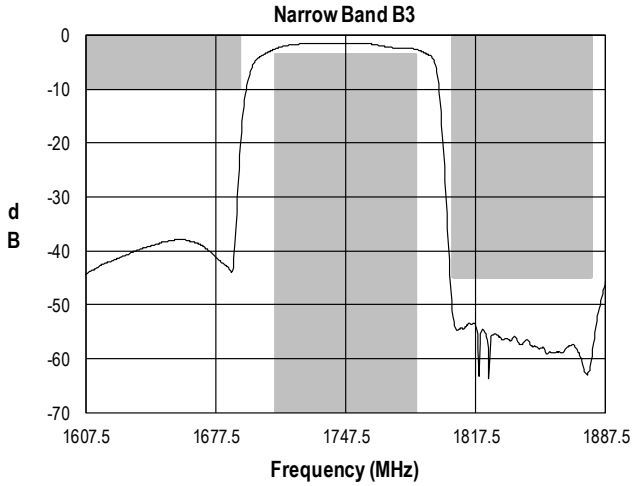

De-embedded Performance Plots – Band 3

Test conditions unless otherwise noted: Temp.=+25 °C

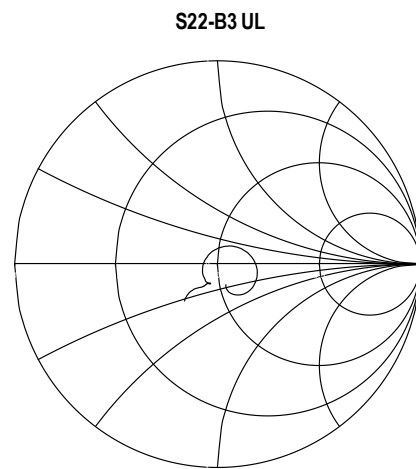
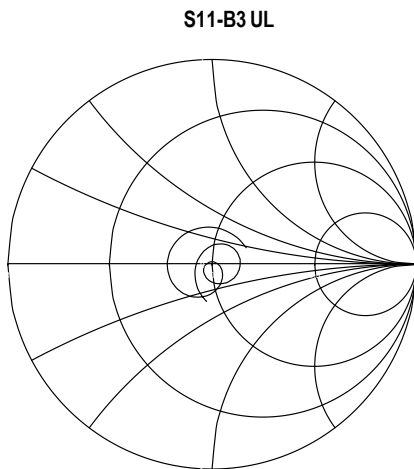
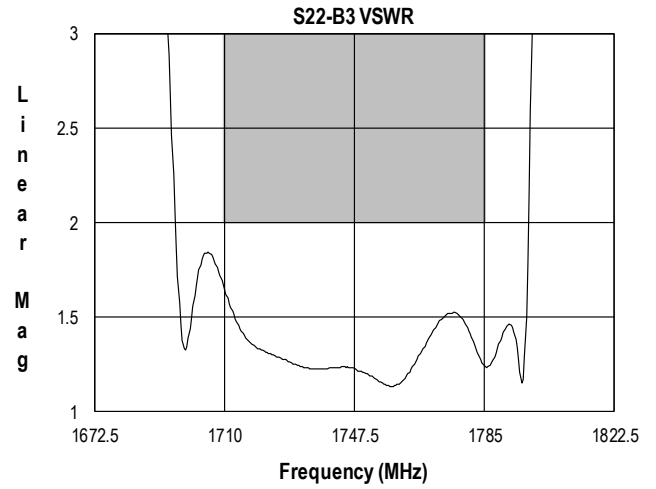
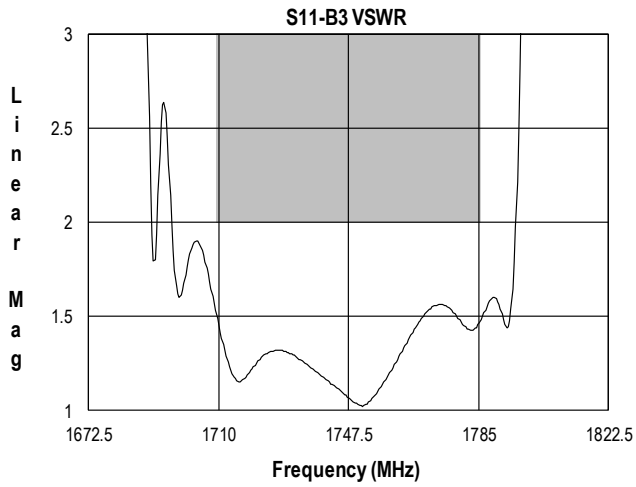

De-embedded Performance Plots – Band 1

Test conditions unless otherwise noted: Temp.=+25 °C

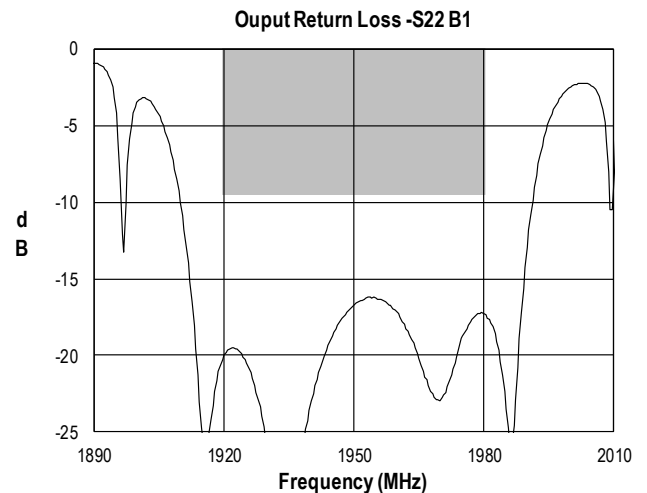
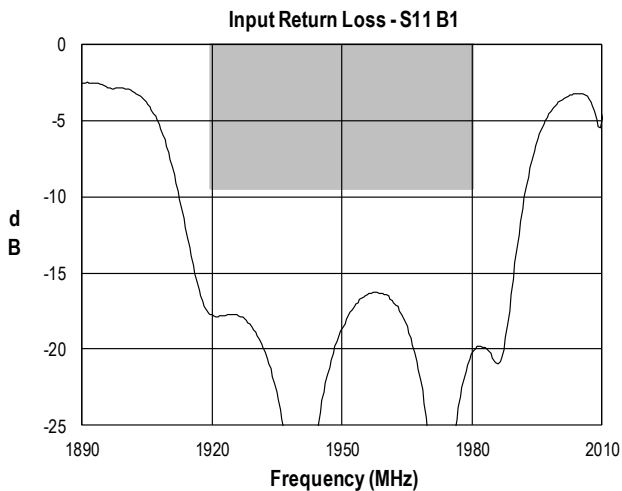
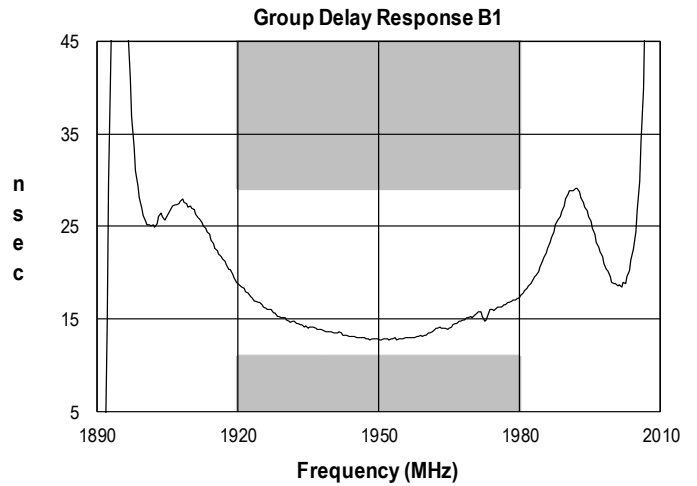
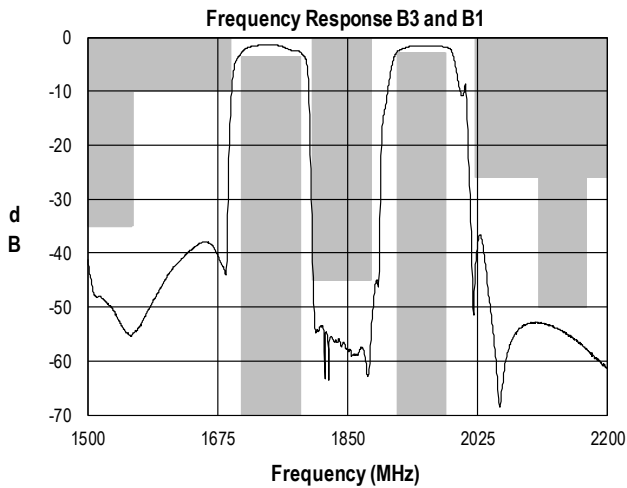
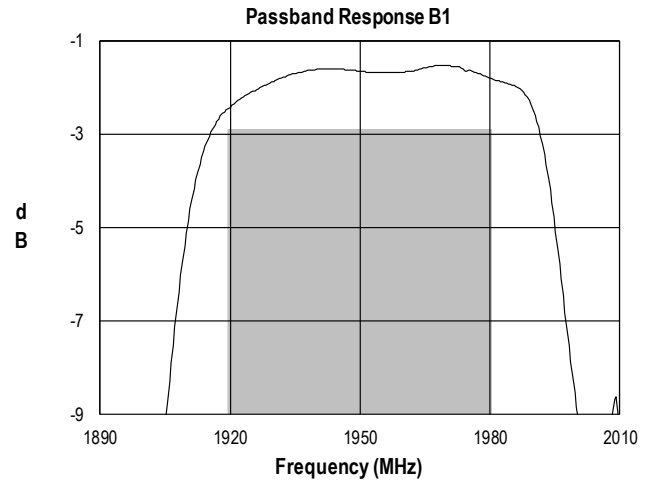
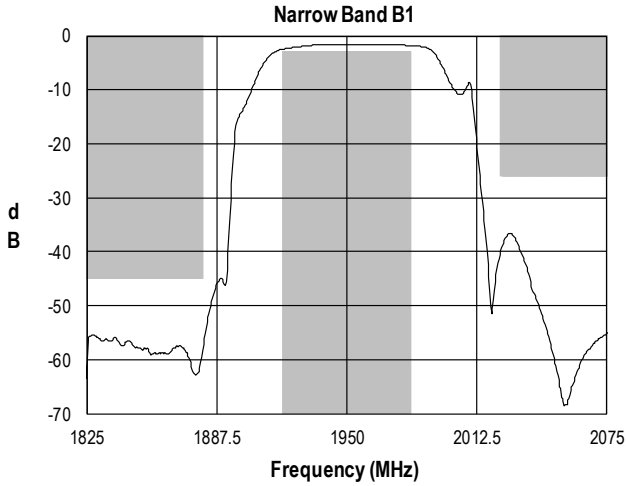

De-embedded Performance Plots – Band 1

Test conditions unless otherwise noted: Temp.=+25 °C

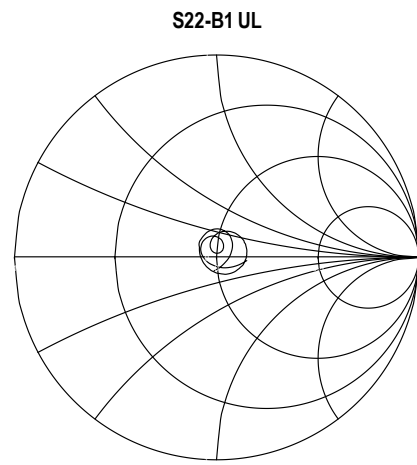
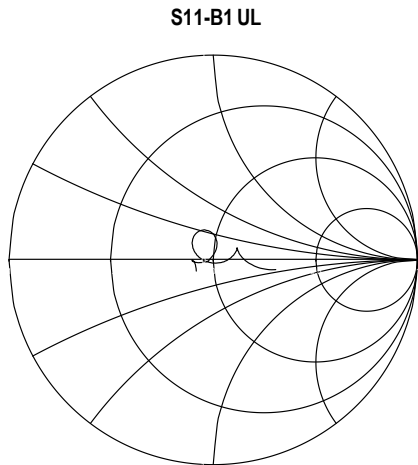
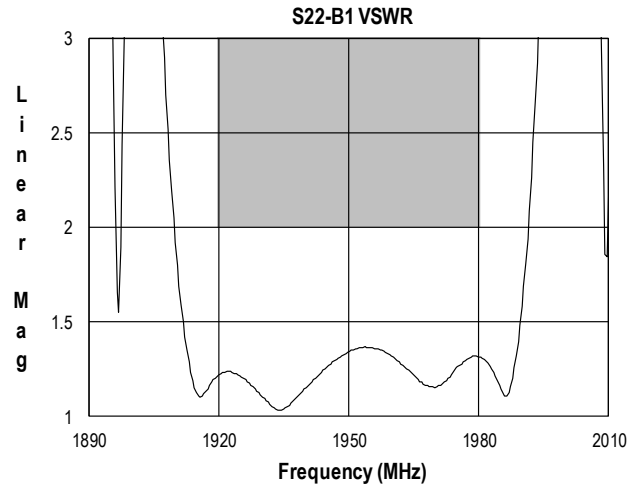
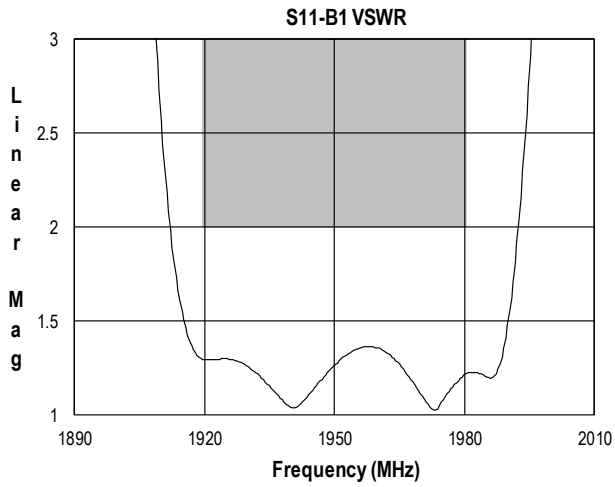

De-embedded Performance Plots – Band 1 and Band 3, Wideband

Test conditions unless otherwise noted: Temp.=+25 °C

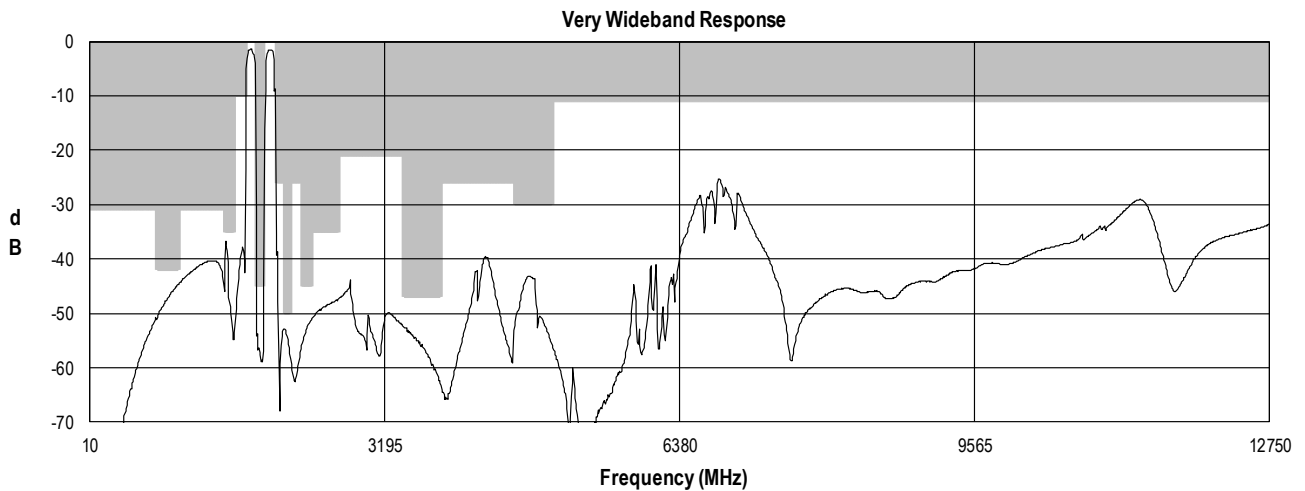
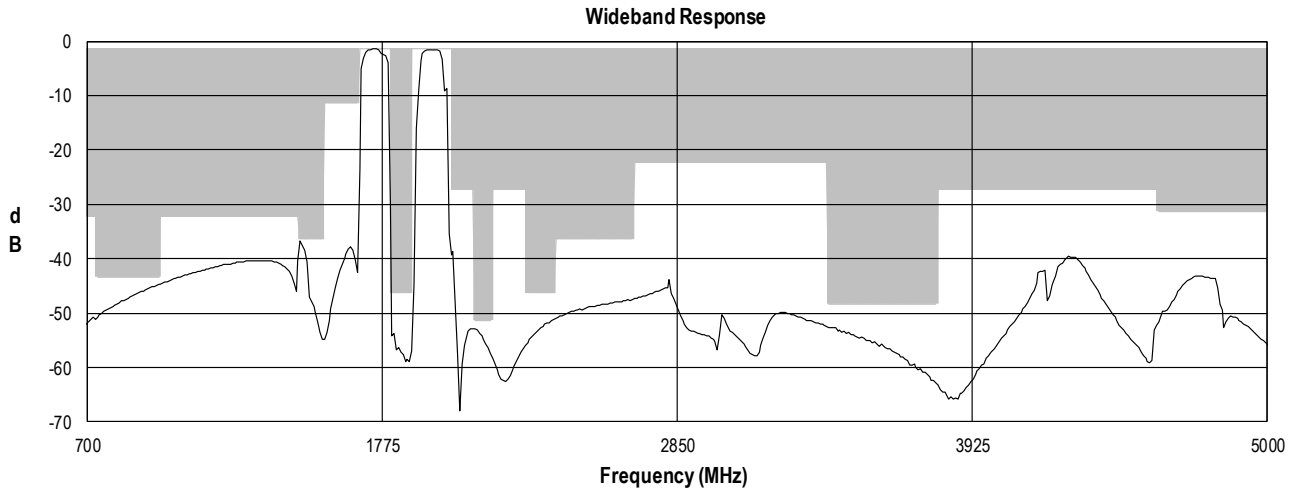

Evaluation Board and Circuit

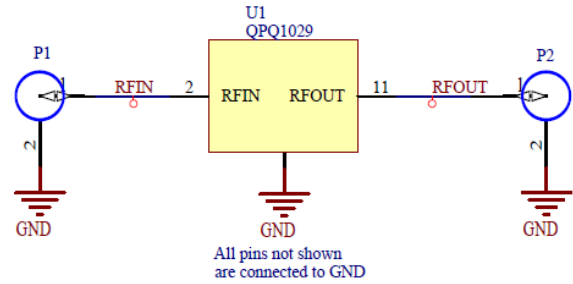
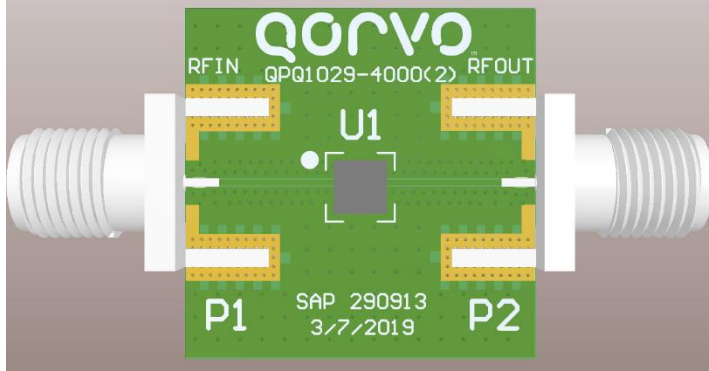

Bill of Material – QPQ1029EVB

Ref. Des.	Value	Description	Manuf.	Part Number
U1	-	Filter, Band 1 and Band 3 Dual Band	Qorvo	QPQ1029
-	-	PCB, Printed Circuit Board	Qorvo	290913
-	-	Connector, SMA Edge Mount	Cinch	142-0701-851

Evaluation Board PCB Information

PC Board Layout

PCB 290913 Material (stack up)

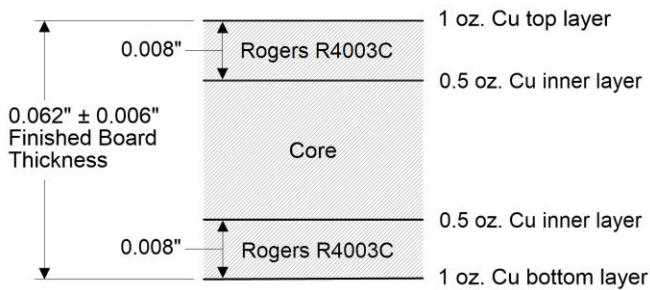

50 Ω line dimensions: width = 0.012", spacing = 0.004"

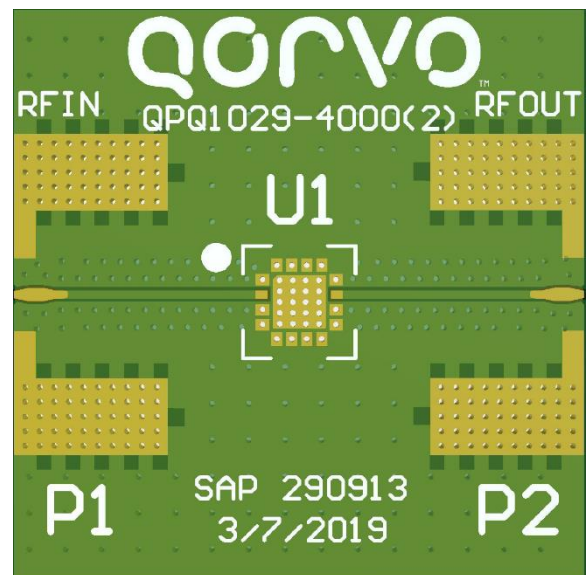

Package Marking and Dimensions

Marking: Qorvo Logo
Part Number – 1029
Trace Code – Assigned by subcontractor

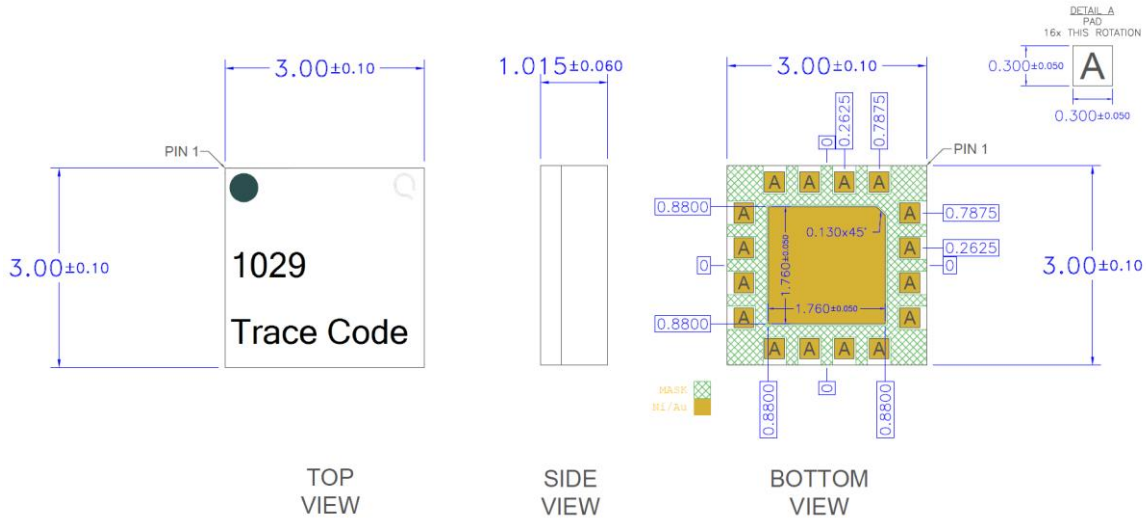

- Notes:
1. All dimensions are in millimeters. Angles are in degrees.
 2. The terminal #1 identifier and terminal numbering conform to JESD 95-1 SPP-012.
 3. Contact plating: Electroless NiPdAu

PCB Mounting Pattern

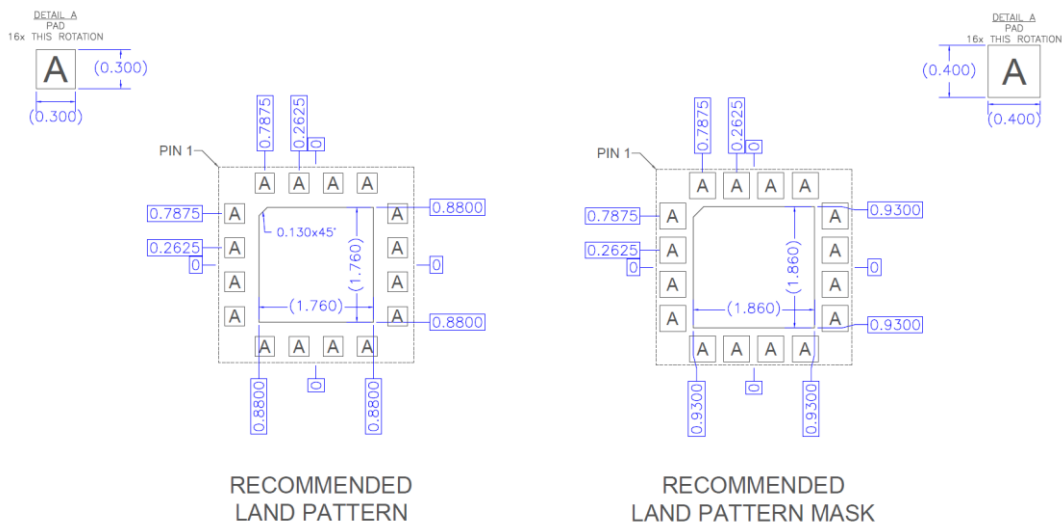

- Notes:
1. All dimensions are in millimeters. Angles are in degrees.

Tape and Reel Information – Carrier and Cover Tape Dimensions

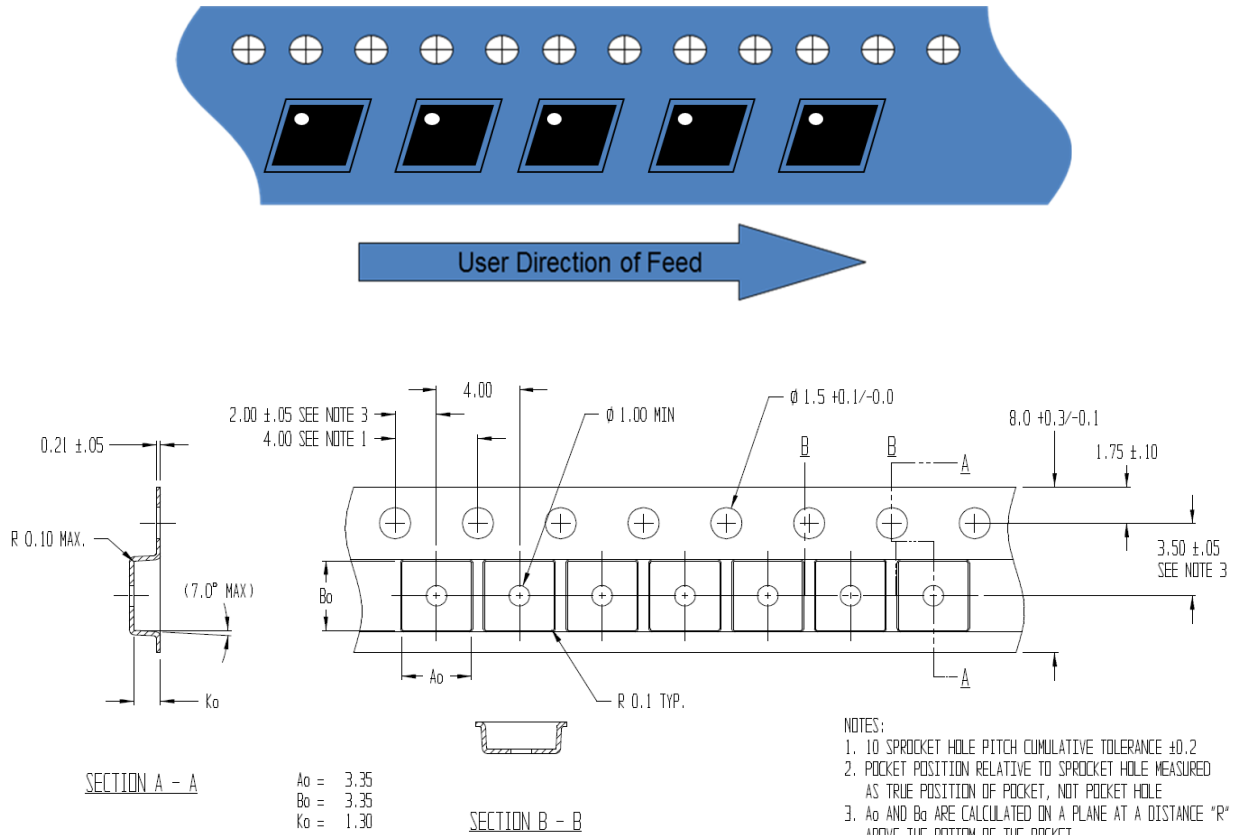

Feature	Measure	Symbol	Size (in)	Size (mm)
Cavity	Length	A0	0.132	3.35
	Width	B0	0.132	3.35
	Depth	K0	0.051	1.30
	Pitch	P1	0.315	4.00
Centerline Distance	Cavity to Perforation - Length Direction	P2	0.079	2.00
	Cavity to Perforation - Width Direction	F	0.138	3.50
Cover Tape	Width	C	0.362	5.40
Carrier Tape	Width	W	0.315	8.00

Tape and Reel Information – Reel Dimensions

Standard T/R size = 2500 pieces on a 7" reel.

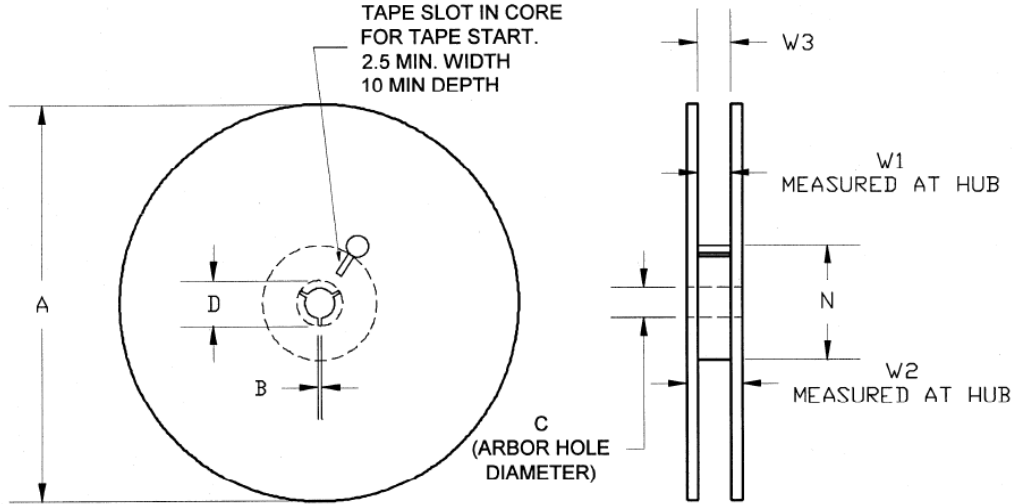

Feature	Measure	Symbol	Size (in)	Size (mm)
Flange	Diameter	A	6.969	177.0
	Thickness	W2	0.559	14.2
	Space Between Flange	W1	0.346	8.8
Hub	Outer Diameter	N	2.283	58.0
	Arbor Hole Diameter	C	0.512	13.0
	Key Slit Width	B	0.079	2.0
	Key Slit Diameter	D	0.787	20.0

Tape and Reel Information – Tape Length and Label Placement

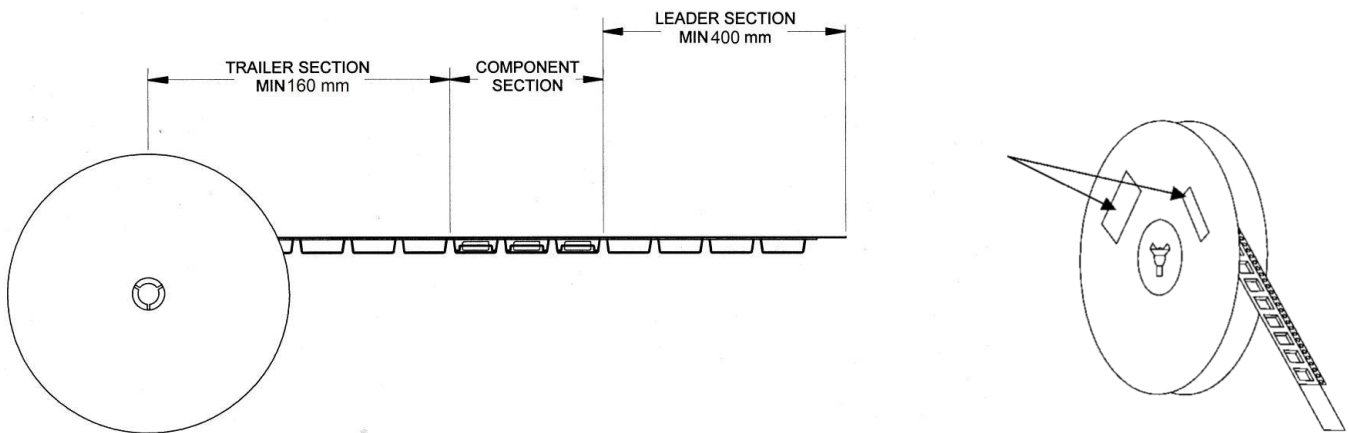

Notes:

1. Empty part cavities at the trailing and leading ends are sealed with cover tape. See EIA 481-1-A.
2. Labels are placed on the flange opposite the sprockets in the carrier tape.

Assembly Notes

Compatible with both lead-free (260°C peak. reflow temp.) and tin/lead (245°C peak. reflow temp.) soldering processes. The use of no-clean solder to avoid washing after soldering is recommended.

Contact plating: Electroless NiPdAu (*Plating thickness: Ni 0.4±0.10µm, Pd 0.145±0.035µm, Au 0.095±0.025µm*)

Recommended Soldering Temperature Profile

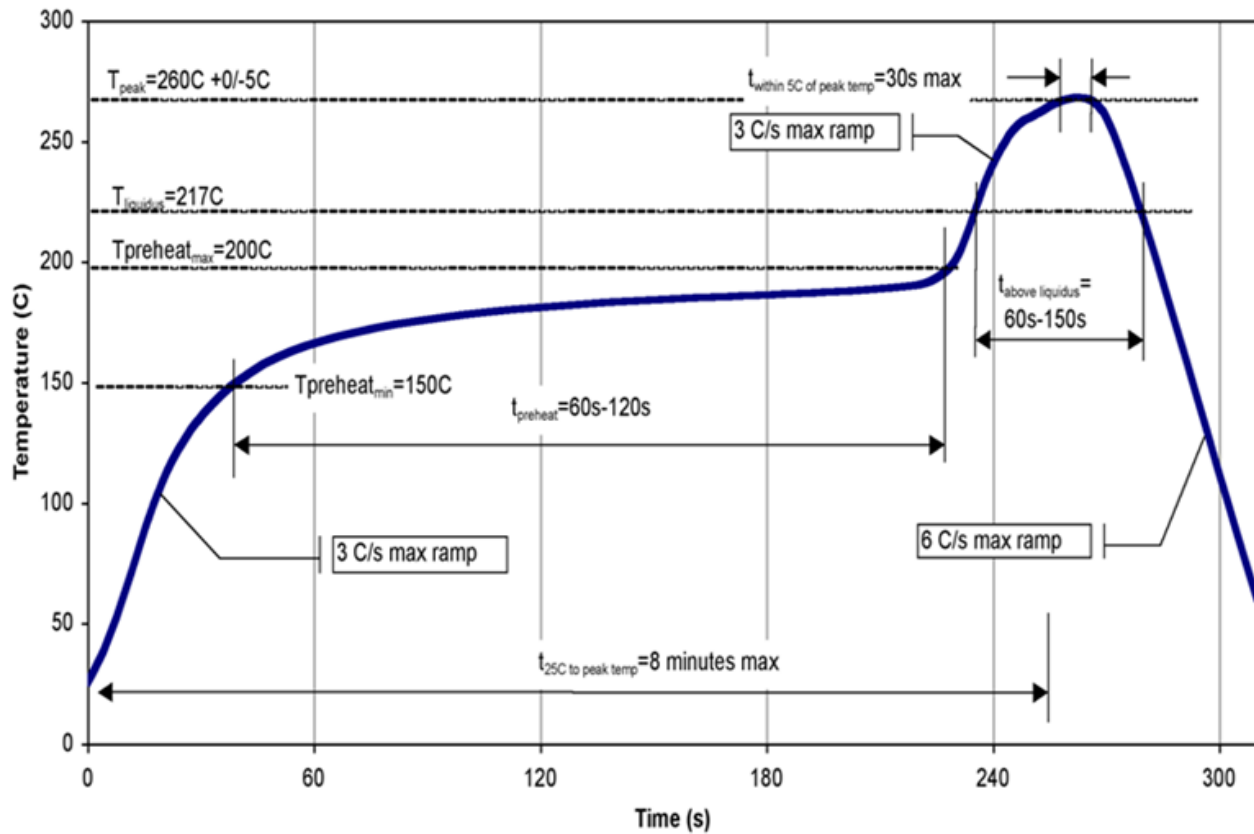

Handling Precautions

Parameter	Rating	Standard
ESD – Human Body Model (HBM)	Class 1C	ESDA / JEDEC JS-001-2012
ESD – Charged Device Model (CDM)	Class C3	JEDEC JESD22-C101F
MSL – Moisture Sensitivity Level	Level 3	IPC/JEDEC J-STD-020



Caution!
ESD-Sensitive Device

RoHS Compliance

This part is compliant with 2011/65/EU RoHS directive (Restrictions on the Use of Certain Hazardous Substances in Electrical and Electronic Equipment) as amended by Directive 2015/863/EU.

This product also has the following attributes:

- Lead Free
- Halogen Free (Chlorine, Bromine)
- Antimony Free
- TBBP-A (C₁₅H₁₂Br₄O₂) Free
- PFOS Free
- SVHC Free



Contact Information

For the latest specifications, additional product information, worldwide sales and distribution locations:

Web: www.qorvo.com

Tel: 1-844-890-8163

Email: customer.support@qorvo.com

Important Notice

The information contained herein is believed to be reliable; however, Qorvo makes no warranties regarding the information contained herein and assumes no responsibility or liability whatsoever for the use of the information contained herein. All information contained herein is subject to change without notice. Customers should obtain and verify the latest relevant information before placing orders for Qorvo products. The information contained herein, or any use of such information does not grant, explicitly or implicitly, to any party any patent rights, licenses, or any other intellectual property rights, whether with regard to such information itself or anything described by such information. **THIS INFORMATION DOES NOT CONSTITUTE A WARRANTY WITH RESPECT TO THE PRODUCTS DESCRIBED HEREIN, AND QORVO HEREBY DISCLAIMS ANY AND ALL WARRANTIES WITH RESPECT TO SUCH PRODUCTS WHETHER EXPRESS OR IMPLIED BY LAW, COURSE OF DEALING, COURSE OF PERFORMANCE, USAGE OF TRADE OR OTHERWISE, INCLUDING THE IMPLIED WARRANTIES OF MERCHANTABILITY AND FITNESS FOR A PARTICULAR PURPOSE.**

Without limiting the generality of the foregoing, Qorvo products are not warranted or authorized for use as critical components in medical, lifesaving, or life-sustaining applications, or other applications where a failure would reasonably be expected to cause severe personal injury or death.

Copyright 2019 © Qorvo, Inc. | Qorvo is a registered trademark of Qorvo, Inc.

X-ON Electronics

Largest Supplier of Electrical and Electronic Components

Click to view similar products for [Signal Conditioning](#) category:

Click to view products by [Qorvo](#) manufacturer:

Other Similar products are found below :

[MAPDCC0001](#) [MAPDCC0004](#) [PD0409J5050S2HF](#) [880157](#) [HHS-109-PIN](#) [DC1417J5005AHF](#) [AFS14A30-2185.00-T3](#) [AFS14A35-1591.50-T3](#) [DS-323-PIN](#) [B39321R801H210](#) [1A0220-3](#) [JP510S](#) [LFB212G45SG8C341](#) [LFB322G45SN1A504](#) [LFL182G45TC3B746](#) [SF2159E](#) [30057](#) [FM-104-PIN](#) [CER0813B](#) [MAPDCC0005](#) [3A325](#) [40287](#) [41180](#) [ATB3225-75032NCT](#) [BD0810N50100AHF](#) [BD2425J50200AHF](#) [C5060J5003AHF](#) [JHS-115-PIN](#) [JP503AS](#) [DC0710J5005AHF](#) [DC2327J5005AHF](#) [DC3338J5005AHF](#) [43020](#) [LFB2H2G60BB1C106](#) [LFL15869MTC1B787](#) [X3C19F1-20S](#) [XC3500P-20S](#) [10013-20](#) [SF2194E](#) [CDBLB455KCAX39-B0](#) [TGL2208-SM, EVAL](#) [RF1353C](#) [1E1305-3](#) [1F1304-3S](#) [1G1304-30](#) [B0922J7575AHF](#) [2020-6622-20](#) [10017-3](#) [TP-103-PIN](#) [BD1222J50200AHF](#)