

3.0 V TO 4.2V, ISM BAND TRANSMIT/RECEIVE MODULE WITH DIVERSITY TRANSFER SWITCH

RFMD
RF3858

KL3828
KLMD

Package: LGA, 32-pin, 8mm x 8mm x 1.2mm



Features

- Integrated LNA, PA and Transfer Switch
- Small Form Factor 8.0mm x 8.0mm x 1.2mm
- 50Ω Inputs and Outputs
- Low Insertion Loss, High Isolation Transfer Switch
- 31.5dBm PA Output Power
- Low PA Harmonic Content

Applications

- 868MHz/900MHz ISM Band Application
- Single Chip RF Front End Module
- Portable Battery Powered Equipment
- Wireless Automatic Metering Applications

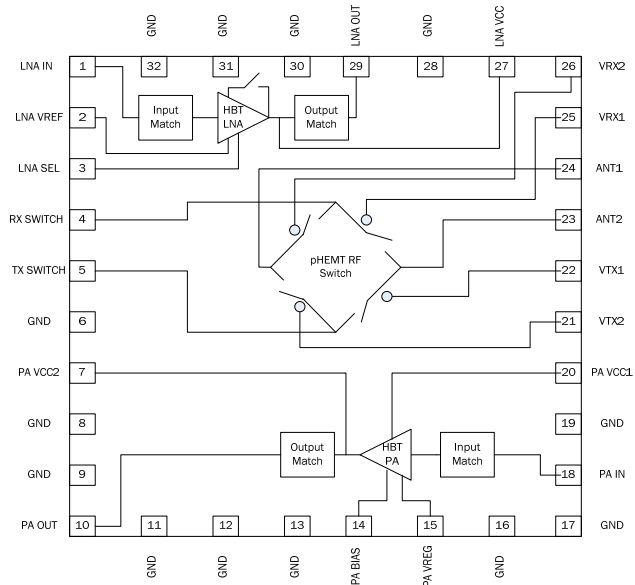

Functional Block Diagram

Product Description

The RF3858 is a single-chip front-end module (FEM) for applications in the 868MHz/900MHz Band. The RF3858 addresses the need for aggressive size reduction for typical portable equipment RF front-end design and greatly reduces the number of components outside of the core chipset thus minimizing the footprint and assembly cost of the overall solution. The RF 3858 contains an integrated 1 Watt PA, TX/RX transfer switch, LNA with bypass mode, and matching components. The RF3858 is packaged in a 32-pin, 8.0mm x 8.0mm x 1.2mm over molded laminated package with backside ground which greatly minimizes next level board space and allow for simplified integration .

Optimum Technology Matching® Applied

- | | | | |
|--|--------------------------------------|--|-----------------------------------|
| <input checked="" type="checkbox"/> GaAs HBT | <input type="checkbox"/> SiGe BiCMOS | <input checked="" type="checkbox"/> GaAs pHEMT | <input type="checkbox"/> GaN HEMT |
| <input type="checkbox"/> GaAs MESFET | <input type="checkbox"/> Si BiCMOS | <input type="checkbox"/> Si CMOS | <input type="checkbox"/> RF MEMS |
| <input type="checkbox"/> InGaP HBT | <input type="checkbox"/> SiGe HBT | <input type="checkbox"/> Si BJT | <input type="checkbox"/> LDMOS |

RF MICRO DEVICES®, RFMD®, Optimum Technology Matching®, Enabling Wireless Connectivity™, PowerStar®, POLARIS™ TOTAL RADIO™ and UltimateBlue™ are trademarks of RFMD, LLC. BLUETOOTH is a trademark owned by Bluetooth SIG, Inc., U.S.A. and licensed for use by RFMD. All other trade names, trademarks and registered trademarks are the property of their respective owners. ©2008, RF Micro Devices, Inc.

3.0 V TO 4.2V, ISM BAND TRANSMIT/RECEIVE MODULE WITH DIVERSITY TRANSFER SWITCH

Absolute Maximum Ratings

Parameter	Rating	Unit
Overall		
DC Supply Voltage	+5.0	V
Operating Ambient Temperature	-40 to +85	°C
Storage Temperature	-40 to +150	°C
Low Noise Amplifier		
DC Supply Current	32	mA
Input RF Power	5	dBm
Power Amplifier		
DC Supply Current	1200	mA
Input RF Power	10	dBm
Transmit/Receive Switch		
Input RF Power	33	dBm



Caution! ESD sensitive device.

Exceeding any one or a combination of the Absolute Maximum Rating conditions may cause permanent damage to the device. Extended application of Absolute Maximum Rating conditions to the device may reduce device reliability. Specified typical performance or functional operation of the device under Absolute Maximum Rating conditions is not implied.

RoHS status based on EUDirective2002/95/EC (at time of this document revision).

The information in this publication is believed to be accurate and reliable. However, no responsibility is assumed by RF Micro Devices, Inc. ("RFMD") for its use, nor for any infringement of patents, or other rights of third parties, resulting from its use. No license is granted by implication or otherwise under any patent or patent rights of RFMD. RFMD reserves the right to change component circuitry, recommended application circuitry and specifications at any time without prior notice.

Parameter	Specification			Unit	Condition
	Min.	Typ.	Max.		
Low Noise Amplifier					
Frequency Range	868	902 to 928		MHz	
High Gain Mode					
Gain	17	21	23.5	dB	Over LNA V _{CC} , LNA V _{REF} , Temperature, and Frequency
Noise Figure		1.3	1.5	dB	LNA V _{REF} = LNA V _{CC} = 3.3V
Input IP3	-4.5	-1		dBm	T _{AMB} = +25 °C, LNA V _{CC} = 3.3V
Input Gain Compression	-15			dBm	
Input Return Loss		-8	-5	dB	
Output Return Loss		-8	-6	dB	
LNA Operating Current			15	mA	LNA V _{REF} = LNA V _{CC} = 3.3V
LNA Enable			1	mA	
Stability, Input VSWR	10:1				All phase angles
Output Spurious			-70	dBc	
Low Gain Mode					
Gain	-7	-6		dB	Gain Select>1.8V
Input IP3	15.5	17		dBm	T _{AMB} = +25 °C, LNA V _{CC} = 3.3V
Current Drain		1.5	3	mA	
Power Amplifier					
Frequency Range	868	902 to 928		MHz	
PA V _{CC1} = PA V _{CC2} = PA BIAS	3.0	4.0		V	
PA V _{REG}	2.75	2.85	2.95	V	
P _{OUT}		31.5		dBm	Saturated power output
Gain	27	30		dB	PA V _{CC1} = PA V _{CC2} = PA BIAS= 4V, over temperature and frequency
Output Harmonic Levels					
2 nd			-40	dBc	
3 rd through 10 th			-70	dBc	PA V _{CC1} = PA V _{CC2} = PA BIAS= 4V, over temperature and frequency
Efficiency	40			%	31.5dBm output, PA V _{CC1} = PA V _{CC2} = PA BIAS, 2.85V V _{REG}
Input Return Loss	9			dB	
Output Spurious			-70	dBc	
Stability					
		10:1			All phase angles
		7:1			All phase angles, -40 °C
Current					
Operating		0.7	1.0	A	31.5dBm output, PA V _{CC1} = PA V _{CC2} = PA BIAS, 2.85V V _{REG}
Bias Only			200	mA	Idle current, no RF at input
I _{REG}		2	5	mA	
Leakage Current		0.1	0.9	µA	Over V _{CC} , Frequency, and Temperature

3.0 V TO 4.2V, ISM BAND TRANSMIT/RECEIVE MODULE WITH DIVERSITY TRANSFER SWITCH

Transmit/receive Switch					
Frequency Range	868	902 to 928		MHz	
Insertion Loss					
TX to ANT1 or ANT2		0.85	1.4	dB	
RX to ANT1 or ANT2		.95	1.4	dB	
Any Path (1800MHz to 1860MHz)	2			dB	
Any Path (2700MHz to 2790MHz)	2			dB	
Any Path (>3600MHz)	15			dB	
Isolation (All Paths)	18			dB	
Input IP3	55			dBm	
Thermal Resistance		47.8		°C/W	4V V _{CC} , 2.85V V _{REG} , 31dBm P _{OUT} , T _{REF} = 85°C
Output Harmonic Levels					
2 nd			-60	dBc	
3 rd through 10 th			-80	dBc	
Input 1dB Gain Compression	30	32		dBm	
Return Loss (All Ports)	18			dB	Active ports only
Switch Control Logic HIGH	2.6		3.5	V	
Switch Control Logic LOW	0		0.2	V	
Switch Control Current			5	µA	VTX2, VRX1, and VRX2
			40	µA	VTX1
Transition Time			2	µs	Settle to 0.25dB of final value

Connected Path	RX SW to ANT1	RX SW to ANT2	TX SW to ANT1	TX SW to ANT2
VRX1	High	Low	Low	Low
VRX2	Low	High	Low	Low
VTX1	Low	Low	High	Low
VTX2	Low	Low	Low	High

*Switch Control Logic High=Min 2.6V to Max 3.5V

*Switch Control Logic Low=Min 0.0V to Max 0.2V

3.0 V TO 4.2V, ISM BAND TRANSMIT/RECEIVE MODULE WITH DIVERSITY TRANSFER SWITCH

Pin	Function	Description
1	LNA IN	RF Input to the low noise amplifier, 50Ω nominal impedance.
2	LNA VREF	Voltage to set the bias level to the LNA, 3.0V nominal, can be used to shut the LNA off or to adjust the quiescent current.
3	LNA SELECT	A logic low selects the high gain mode of the LNA, logic high selects the low gain mode.
4	RX SWITCH INPUT	RF port from the Switch going to the LNA input, 50Ω nominal impedance.
5	TX SWITCH INPUT	RF port from the Switch going to the PA input, 50Ω nominal impedance.
6	GND	Ground.
7	PA VCC2	Voltage supply for the Power Amplifier, nominal voltage is 3.6V.
8	GND	Ground.
9	GND	Ground.
10	PA OUT	RF output from the Power Amplifier, 50Ω nominal impedance.
11	GND	Ground.
12	GND	Ground.
13	GND	Ground.
14	PA BIAS	Voltage supply for the Power Amplifier bias network, nominal voltage is 3.6V.
15	PA VREG	Voltage to set the bias level of the Power Amplifier, nominal voltage is 2.85V.
16	GND	Ground.
17	GND	Ground.
18	PA IN	RF Input to the Power Amplifier, 50Ω nominal impedance.
19	GND	Ground.
20	PA VCC1	Voltage supply for the Power Amplifier, nominal voltage is 3.6V
21	VTX2	Logic input to the Switch, see Logic Table below.
22	VTX1	Logic input to the Switch, see Logic Table below.
23	ANT2	RF port from the Switch going to Antenna 1, 50Ω nominal impedance.
24	ANT1	RF port from the Switch going to Antenna 2, 50Ω nominal impedance.
25	VRX1	Logic input to the Switch, see Logic Table below.
26	VRX2	Logic input to the Switch, see Logic Table below.
27	LNA VCC	LNA Collector Voltage, nominal voltage is 3.0V.
28	GND	Ground.
29	LNA OUT	RF Output from the low noise amplifier, 50Ω nominal impedance.
30	GND	Ground.
31	GND	Ground.
32	GND	Ground.
Pkg Base	GND	The central metal base of package provides DC and RF GND as well as heat sink for the amplifier.

Package Drawing

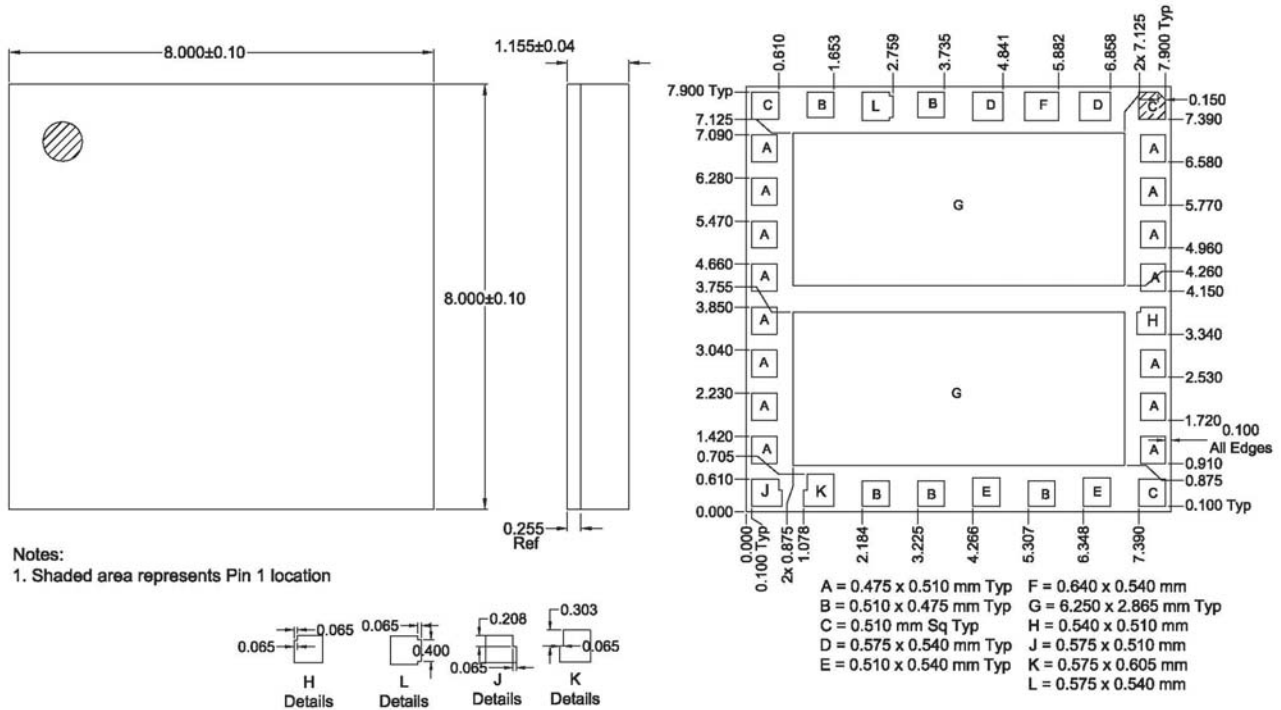

All units in μm .
 Pin A= 510 x 475
 Pin B= 510 x 510
 Pin C= 475 x 510

PCB Patterns

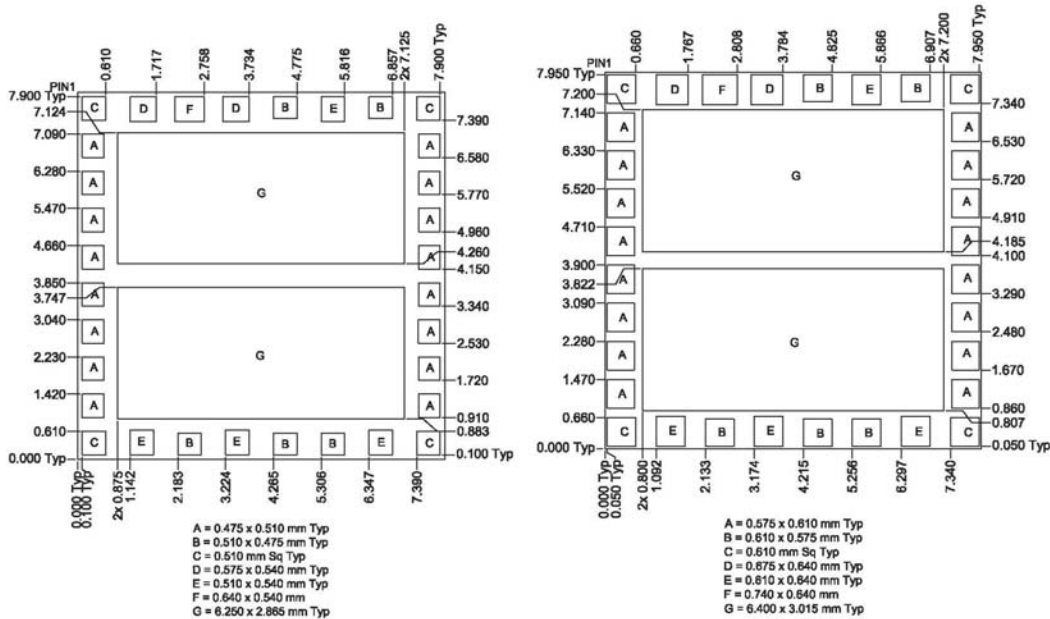

PCB METAL LAND PATTERN

PCB SOLDER MASK PATTERN

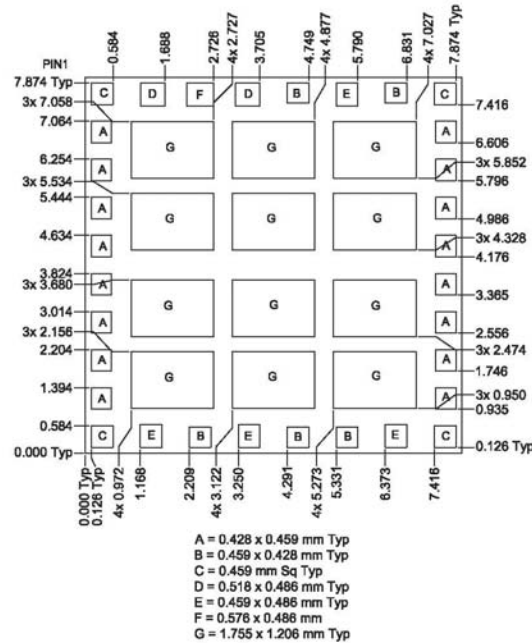

PCB STENCIL PATTERN

Thermal vias for center slug “G” should be incorporated into the PCB design. The number and size of thermal vias will depend on the application. Example of the number and size of vias can be found on the RFMD Evaluation board layout.

RF MICRO DEVICES®, RFMD®, Optimum Technology Matching®, Enabling Wireless Connectivity™, PowerStar®, POLARIS™ TOTAL RADIO™ and UltimateBlue™ are trademarks of RFMD, LLC. BLUETOOTH is a trademark owned by Bluetooth SIG, Inc., U.S.A. and licensed for use by RFMD. All other trade names, trademarks and registered trademarks are the property of their respective owners. ©2009, RF Micro Devices, Inc.

Pin Out

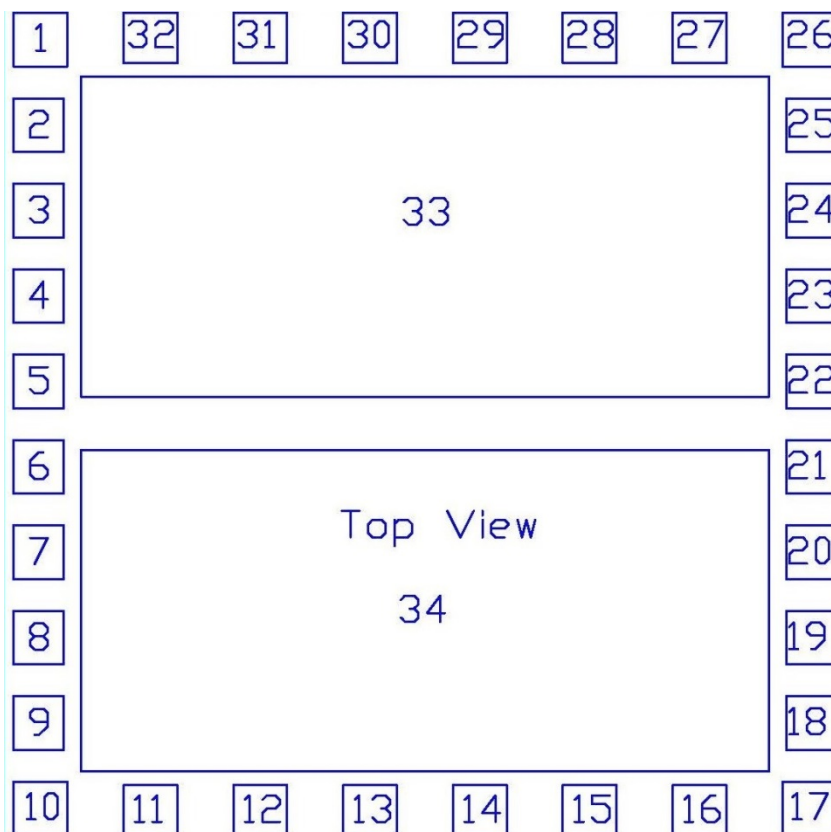

Application Schematic

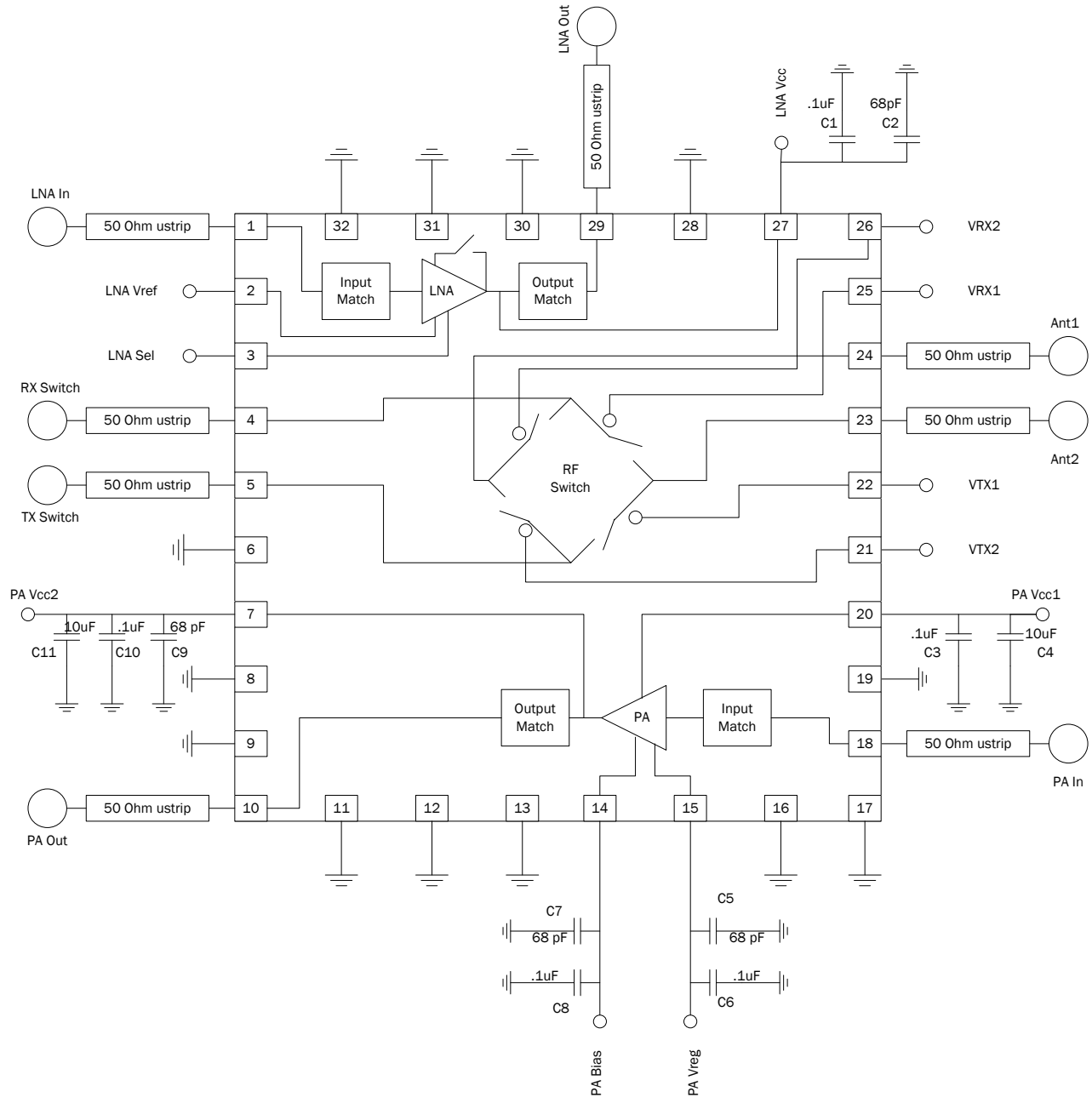

3.0 V TO 4.2V, ISM BAND TRANSMIT/RECEIVE MODULE WITH DIVERSITY TRANSFER SWITCH

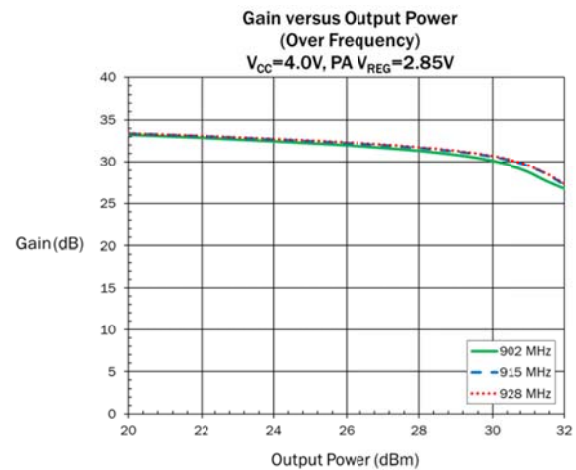
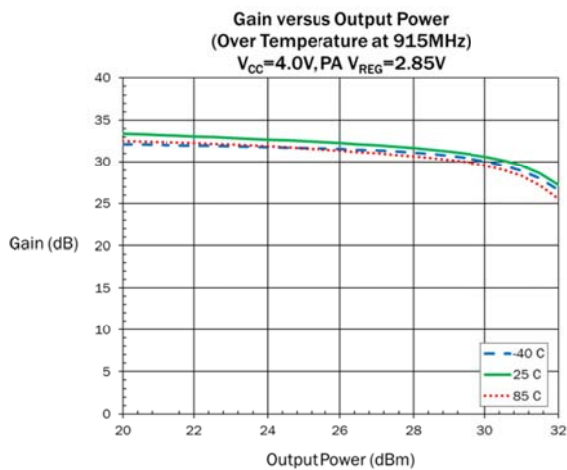
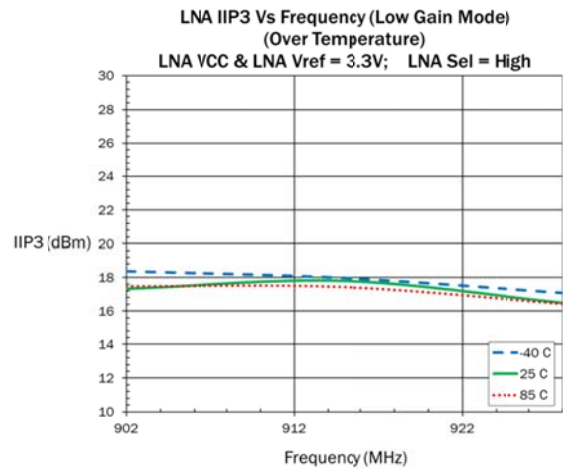
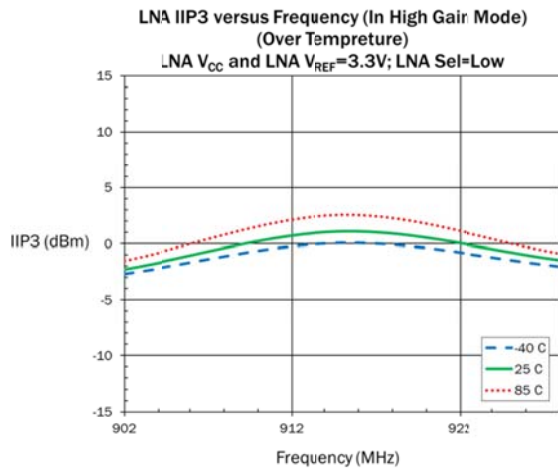
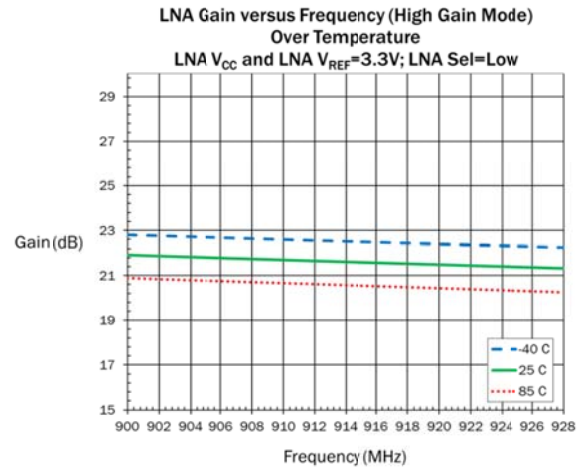
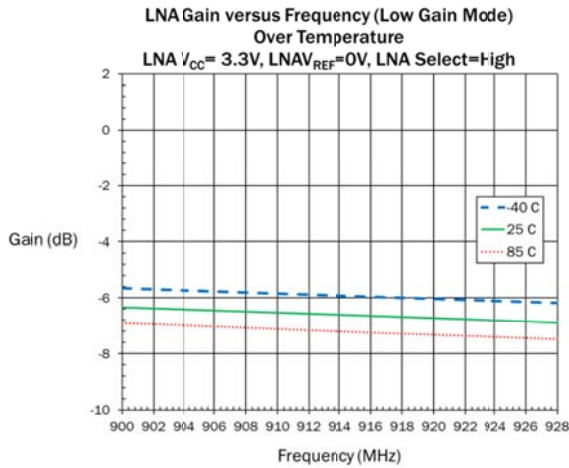

RF MICRO DEVICES®, RFMD®, Optimum Technology Matching®, Enabling Wireless Connectivity™, PowerStar®, POLARIS™ TOTAL RADIO™ and UltimateBlue™ are trademarks of RFMD, LLC. BLUETOOTH is a trademark owned by Bluetooth SIG, Inc., U.S.A. and licensed for use by RFMD. All other trade names, trademarks and registered trademarks are the property of their respective owners. ©2009, RF Micro Devices, Inc.

3.0 V TO 4.2V, ISM BAND TRANSMIT/RECEIVE MODULE WITH DIVERSITY TRANSFER SWITCH

Gain versus Output Power
(Over PA V_{REG} at 915MHz)
 $V_{CC}=4.0V$

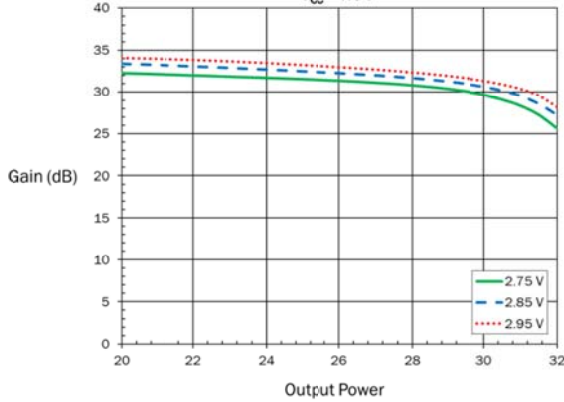

Power Amplifier Operating Current versus Output Power
(Over Temperature at 915MHz)
 $V_{CC}=4.0V, PA V_{REG}=2.85V$

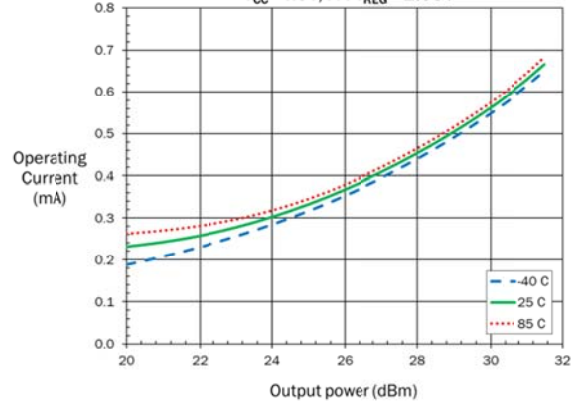

Power Amplifier Operating Current versus Output Power
(Over V_{CC} at 915MHz)
 $V_{REG}=2.85V$

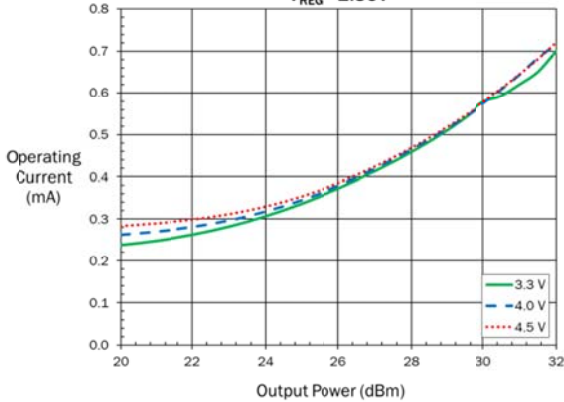

Power Amplifier Operating Current versus Output Power
(Over Frequency)
 $V_{CC}=4.0V, PA V_{REG}=2.85V$

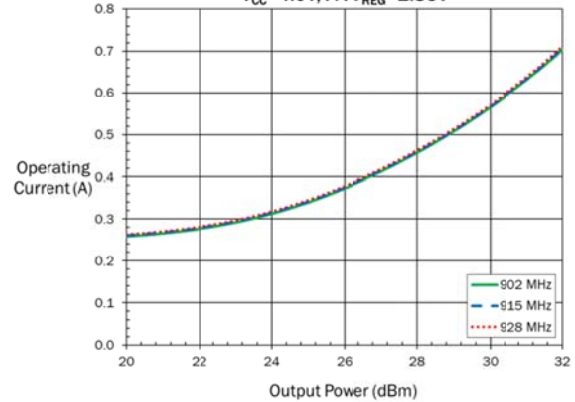

Input Power versus Output Power
(Over Temperature)
 $V_{CC}=4.0V, PA V_{REG}=2.85V$

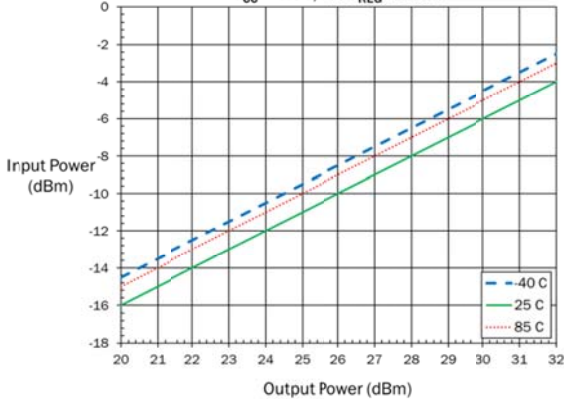

Input Power versus Output Power
 $V_{CC}=4.0V, PA V_{REG}=2.85V$

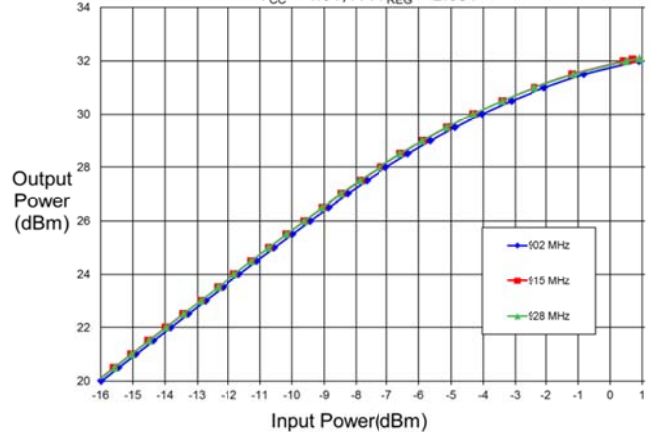

RF MICRO DEVICES®, RFMD®, Optimum Technology Matching®, Enabling Wireless Connectivity™, PowerStar®, POLARIS™ TOTAL RADIO™ and UltimateBlue™ are trademarks of RFMD, LLC. BLUETOOTH is a trademark owned by Bluetooth SIG, Inc., U.S.A. and licensed for use by RFMD. All other trade names, trademarks and registered trademarks are the property of their respective owners. ©2009, RF Micro Devices, Inc.

Ordering Information

Ordering Code	Description
RF3858	Standard 25 piece bag
RF3858SR	Standard 100 piece reel
RF3858TR13	Standard 25 piece reel
RF3858PCK-410	Fully Assembled Evaluation board and 5 loose sample pieces

X-ON Electronics

Largest Supplier of Electrical and Electronic Components

Click to view similar products for [RF Front End](#) category:

Click to view products by [Qorvo](#) manufacturer:

Other Similar products are found below :

[SE2622L-R](#) [BGM1032N7E6327XUSA1](#) [LX5586LL](#) [LX5586HLL](#) [LX5586ALL](#) [SKY66111-21](#) [SKY65728-11](#) [SKY68000-31](#) [SKY85308-11](#)
[SKY85302-11](#) [SKY65724-11](#) [ADTR1107ACCZ](#) [LMP91051MTX/NOPB](#) [SE5501L-R](#) [QPF4519SR](#) [SE5503A-R](#) [ADA8282WBCPZ](#)
[ADRF5545ABCPZN](#) [ADRF5545ABCPZN-R7](#) [AD8283WBCPZ](#) [AD8284WCSVZ](#) [ADRF5547BCPZN](#) [ADRF5547BCPZN-R7](#)
[ADRF5549BCPZN](#) [ADRF5549BCPZN-R7](#) [HV7350K6-G](#) [SE5516A-R](#) [MCP2030-I/SL](#) [MAX2009ETI+](#) [MAX2078CTK+](#) [MAX2335ETI+](#)
[MAX2678GTB/V+T](#) [MD2131K7-G](#) [MD2134K7-G](#) [RFFM6903TR13](#) [HV7351K6-G](#) [MCP2035-I/ST](#) [SE2614BT-R](#) [SE2438T-R](#) [SST12LF02-](#)
[QXCE](#) [SST12LF09-Q3CE](#) [RFX2401C](#) [RFX2402E](#) [SKY85201-11](#) [RFFM4591FTR7](#) [RFFM8211TR7](#) [RFFM4293TR7](#) [RFFM4203TR7](#)
[RFFM5765QTR7](#) [RFFM8200TR7](#)