



Features

- 8.5V Single Supply
- 5MHz to 2500MHz Operation
- Gain: 14.5dB at 500MHz
- OIP3: 42dBm at 500MHz
- Noise Figure: 3.7dB at 500MHz
- SOT-89 Package

Applications

- CATV Distribution Amplifiers
- Cable Modems
- Broadband Cable Blocks
- Laser Diode Driver
- Return Channel Amplifier

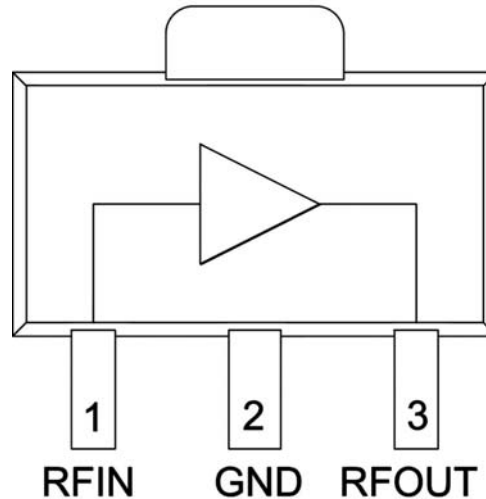

Functional Block Diagram

Product Description

RFMD's RFCA3310 is a low-cost 75Ω cascadable gain block MMIC amplifier. Its gain flatness and high linearity make it ideal for cable TV applications. The RFCA3310 is manufactured on a proven RFMD GaAs HBT process.

Ordering Information

RFCA3310SQ	25 piece sample bag
RFCA3310SR	7" Sample reel with 100 pieces
RFCA3310TR13	13" Reel with 2500 pieces
RFCA3310PCK-410	5MHz to 2500MHz, PCBA with 5-piece sample bag

Optimum Technology Matching® Applied

- | | | | |
|--|--------------------------------------|-------------------------------------|------------------------------------|
| <input checked="" type="checkbox"/> GaAs HBT | <input type="checkbox"/> SiGe BiCMOS | <input type="checkbox"/> GaAs pHEMT | <input type="checkbox"/> GaN HEMT |
| <input type="checkbox"/> GaAs MESFET | <input type="checkbox"/> Si BiCMOS | <input type="checkbox"/> Si CMOS | <input type="checkbox"/> BiFET HBT |
| <input type="checkbox"/> InGaP HBT | <input type="checkbox"/> SiGe HBT | <input type="checkbox"/> Si BJT | <input type="checkbox"/> SOI |

RF MICRO DEVICES®, RFMD®, Optimum Technology Matching®, Enabling Wireless Connectivity™, PowerStar®, POLARIS™ TOTAL RADIO™ and UltimateBlue™ are trademarks of RFMD, LLC. BLUETOOTH is a trademark owned by Bluetooth SIG, Inc., U.S.A. and licensed for use by RFMD. All other trade names, trademarks and registered trademarks are the property of their respective owners. ©2012, RF Micro Devices, Inc.

Absolute Maximum Ratings

Parameter	Rating	Unit
Max Device Current (I_D)	170	mA
Max Device Voltage (V_D)	9	V
CW RF Input Power, 50 output VSWR	18	dBm
Max Operating Junction Temp (T_J)	165	°C
Operating Temperature Range (T_L)	-40 to +85	°C
Storage Temperature	-40 to +150	°C
ESD Rating - Human Body Model	Class 0	
Moisture Sensitivity Level	MSL2	



Caution! ESD sensitive device.

Exceeding any one or a combination of the Absolute Maximum Rating conditions may cause permanent damage to the device. Extended application of Absolute Maximum Rating conditions to the device may reduce device reliability. Specified typical performance or functional operation of the device under Absolute Maximum Rating conditions is not implied.

The information in this publication is believed to be accurate and reliable. However, no responsibility is assumed by RF Micro Devices, Inc. ("RFMD") for its use, nor for any infringement of patents, or other rights of third parties, resulting from its use. No license is granted by implication or otherwise under any patent or patent rights of RFMD. RFMD reserves the right to change component circuitry, recommended application circuitry and specifications at any time without prior notice.



RFMD Green: RoHS compliant per EU Directive 2002/95/EC, halogen free per IEC 61249-2-21, < 1000ppm each of antimony trioxide in polymeric materials and red phosphorus as a flame retardant, and <2% antimony in solder.

Notes:

1. The maximum ratings must all be met simultaneously.
2. $P_{DISS} = P_{DC} + R_{RFIN} - R_{RFOUT}$
3. $T_J = T_L + P_{DISS} * R_{TH}$

Parameter	Specification			Unit	Condition
	Min.	Typ.	Max.		
Downstream Performance Overall (75Ω)					50MHz to 1000MHz Application, $V_D = 8.5V$, $I_D = 147mA$, $T_L = 25°C$, $Z_S = Z_L = 75Ω$
Frequency Range	50		1000	MHz	
Small Signal Gain at 50MHz	14.3	14.9	15.7	dB	
Small Signal Gain at 500MHz	14	14.5	15.4	dB	
Small Signal Gain at 1000MHz	13.6	14	15	dB	
Gain Flatness	-0.9	-0.7	-0.3	dB	
P1dB		22		dBm	
Noise Figure		3.6		dB	
Input Return Loss		20		dB	50MHz
		7.7		dB	1000MHz
Output Return Loss		16		dB	50MHz
		9		dB	1000MHz
Stability Factor	Conditional Stability (see plot for details)				50Ω EVB and S-parameter calibration
Output IP3	41.5	45		dBm	50MHz, Tone spacing = 6MHz, P_{OUT} per Tone = +5dBm
	30	33.5		dBm	1000MHz, Tone spacing = 6MHz, P_{OUT} per Tone = +5dBm
Output IP2		66		dBm	50MHz, Tone spacing = 30MHz, P_{OUT} per Tone = +0dBm
		46.5		dBm	1000MHz, Tone spacing = 30MHz, P_{OUT} per Tone = +0dBm
CSO		63		dBc	79 Channels to 550MHz, +29dBmV out
CTB		92		dBc	
XMOD		89		dBc	

Parameter	Specification			Unit	Condition
	Min.	Typ.	Max.		
Upstream Performance (75Ω)					5MHz to 200MHz Application, $V_D=8.5V$, $I_D=142mA$, $T_L = 25^\circ C$, $Z_S = Z_L = 75\Omega$
Frequency Range	5		200	MHz	
Small Signal Gain at 5MHz	14.5	14.6	15.5	dB	
Small Signal Gain at 50MHz	14.2	14.9	15.2	dB	
Small Signal Gain at 200MHz	14	14.6	15	dB	
Gain Flatness		0		dB	
P1dB		23.5		dBm	
Noise Figure		3.7		dB	
Input Return Loss		26		dB	50MHz
Output Return Loss		18		dB	50MHz
Stability Factor	Conditional Stability (see plot for details)				50Ω EVB and S-parameter calibration
Output IP3		47		dBm	13MHz, Tone Spacing=6MHz, P_{OUT} per Tone = +6.25dBm
Output IP2		68		dBm	
CSO		61		dBc	7 Channel to 50MHz, +49.5dBmV out
CTB		84		dBc	
XMOD		80		dBc	
Power Supply					
Device Operating Voltage (V_D)		8.5	8.75	V	
Device Operating Current (I_D)		147	168	mA	Quiescent, $V_D=8.5V$
Thermal Resistance (R_{TH})		49		$^\circ C/W$	Junction-to-Pin4, at Quiescent current, $V_D=8.5V$

Performance Downstream Application Circuit $V_{CC} = 8.5V$, $I_{CC} = 147mA$

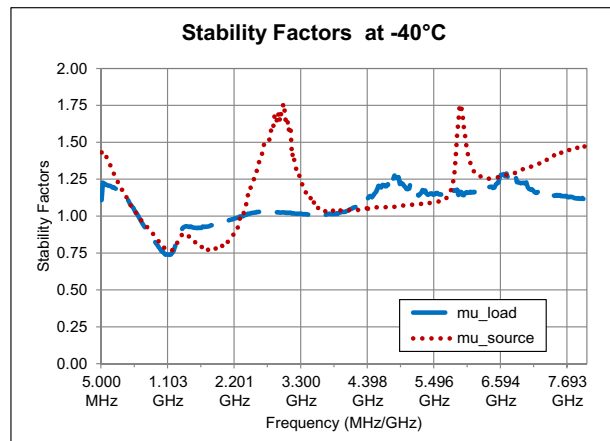
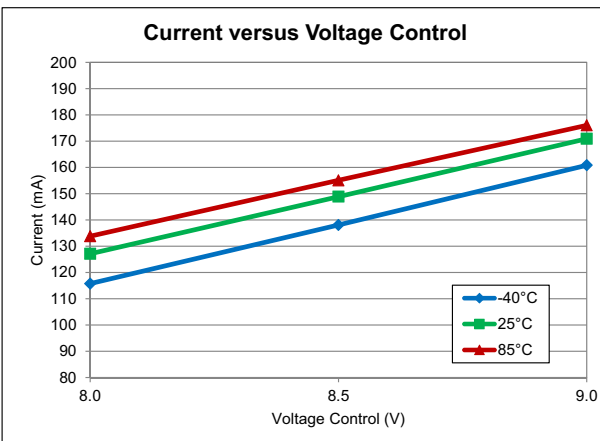
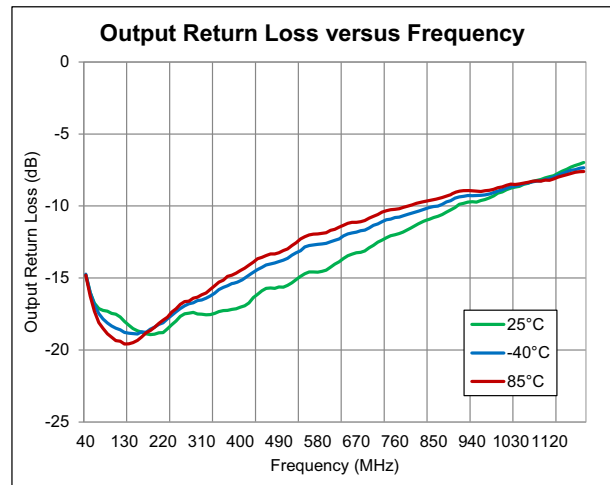
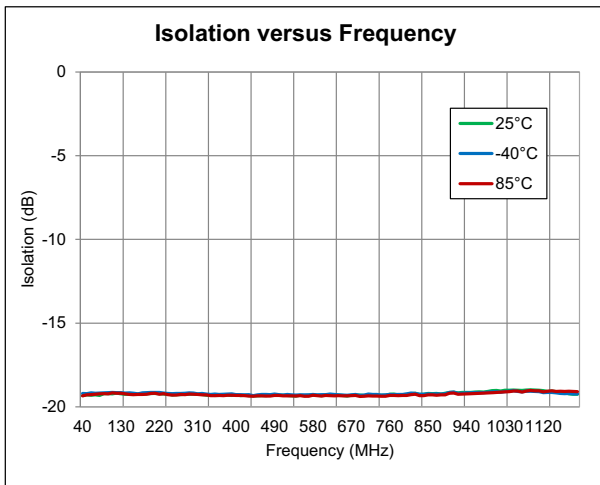
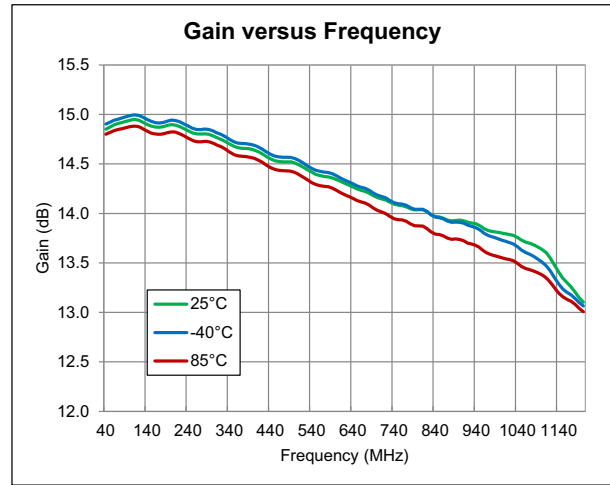
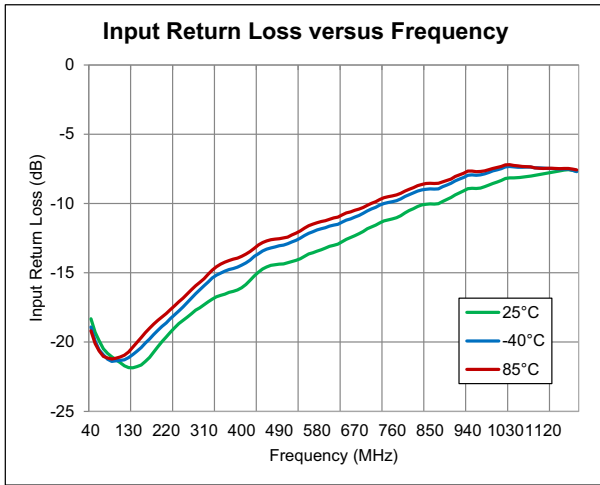

Performance Downstream Application Circuit $V_{CC} = 8.5V$, $I_{CC} = 147mA$

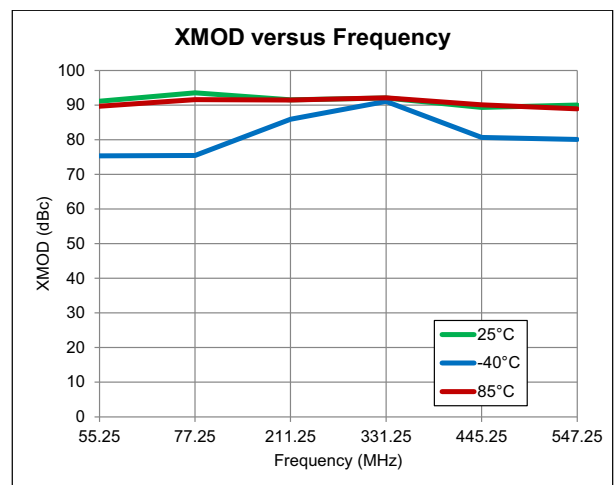
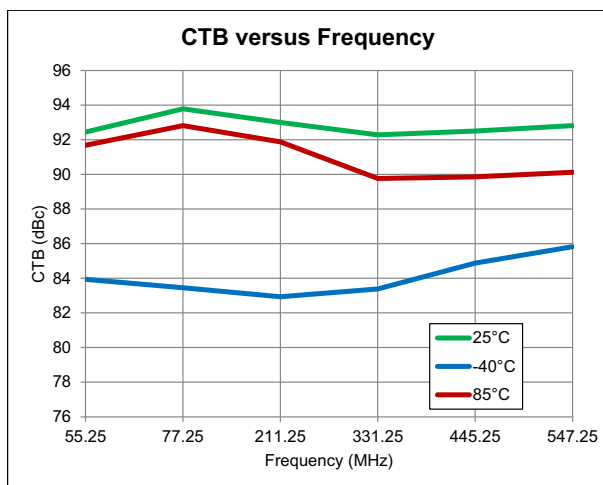
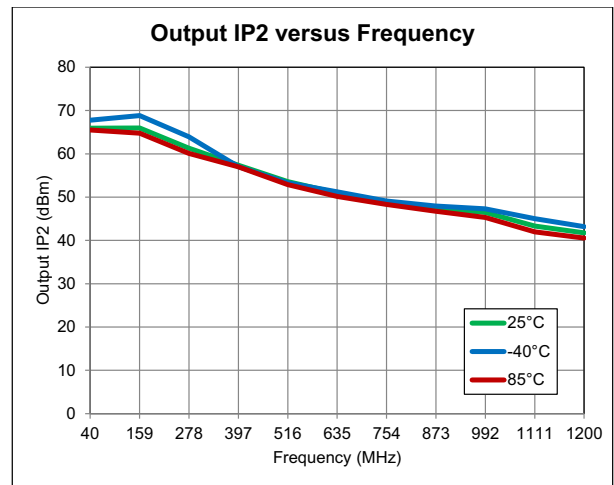
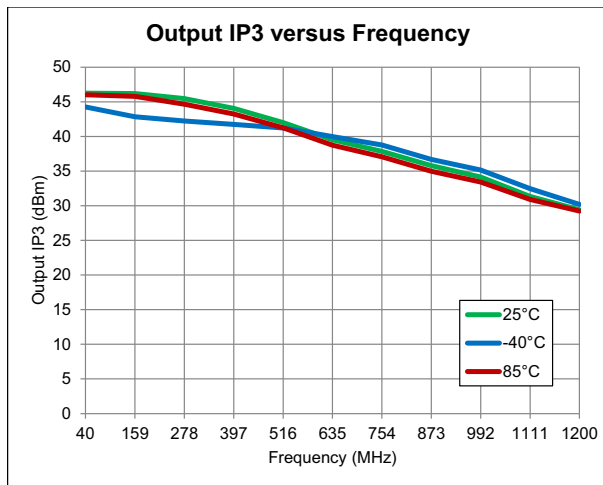
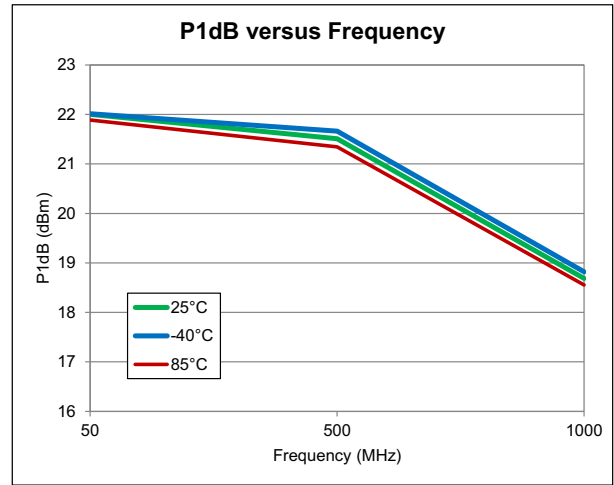
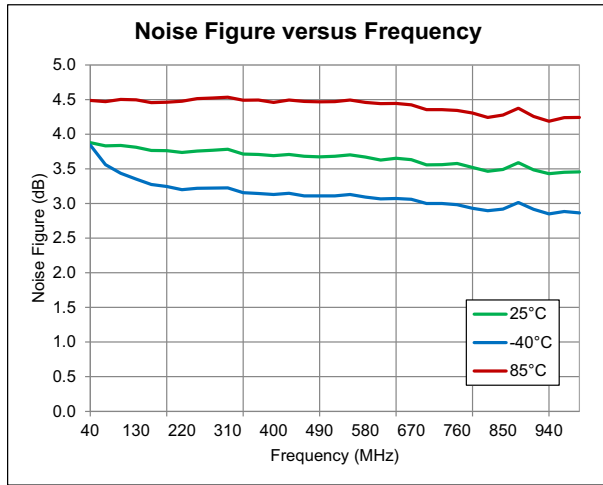

Performance Downstream Application Circuit $V_{CC} = 8.5V$, $I_{CC} = 147mA$

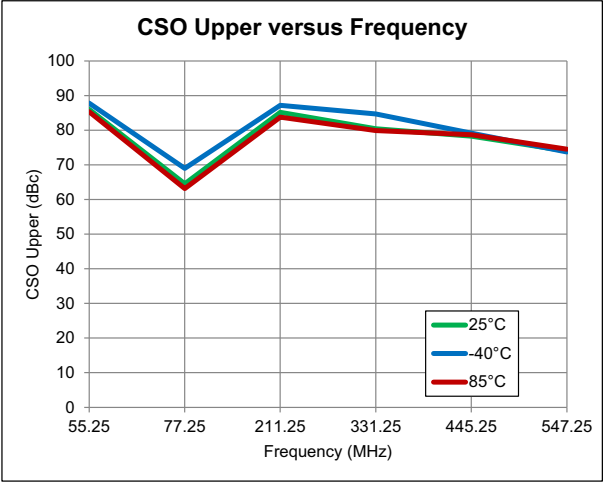
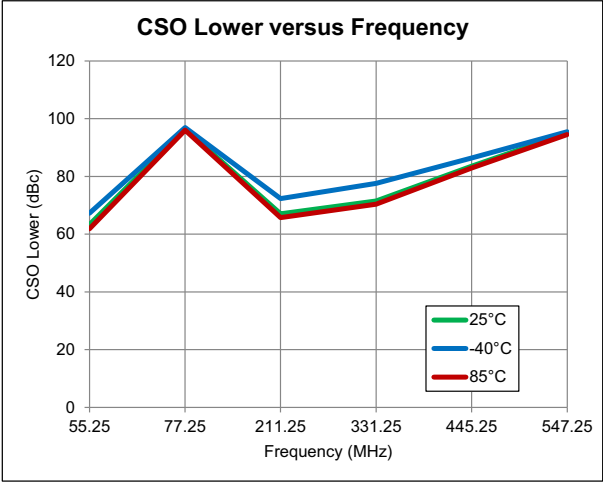

Performance Upstream Application Circuit $V_{CC} = 8.5V$, $I_{CC} = 147mA$

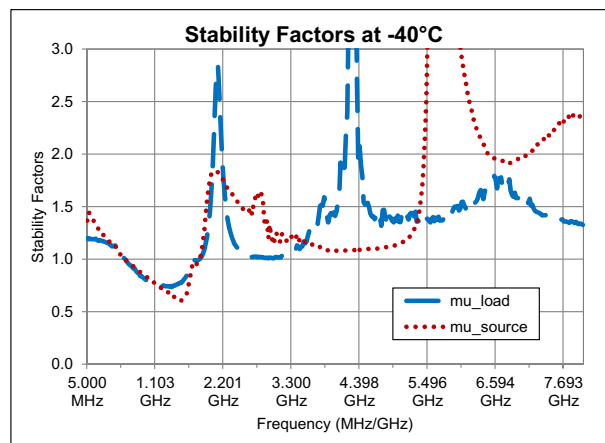
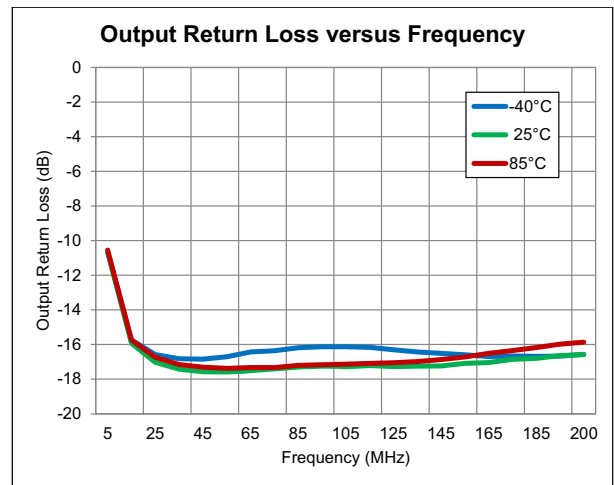
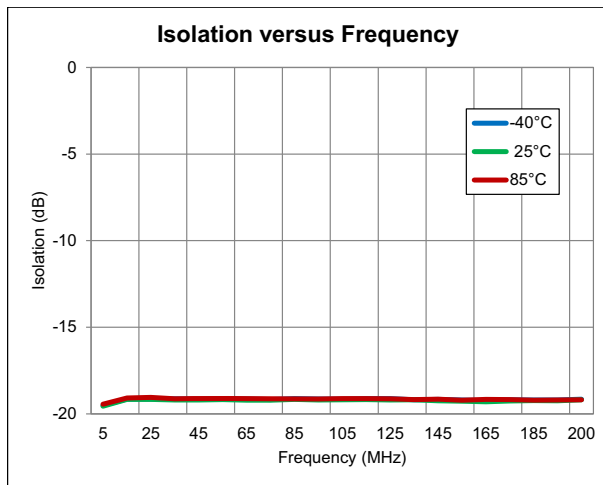
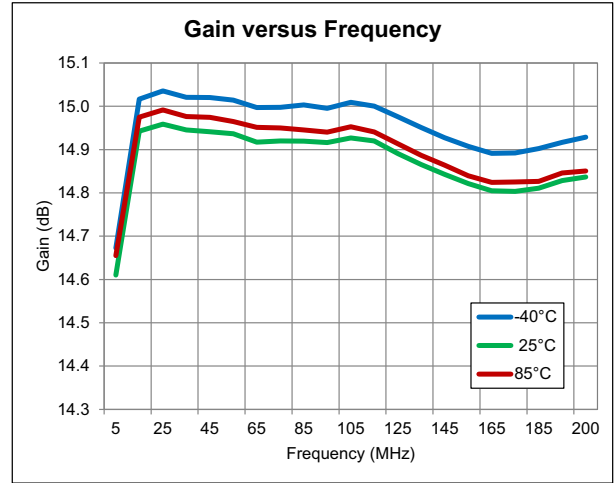
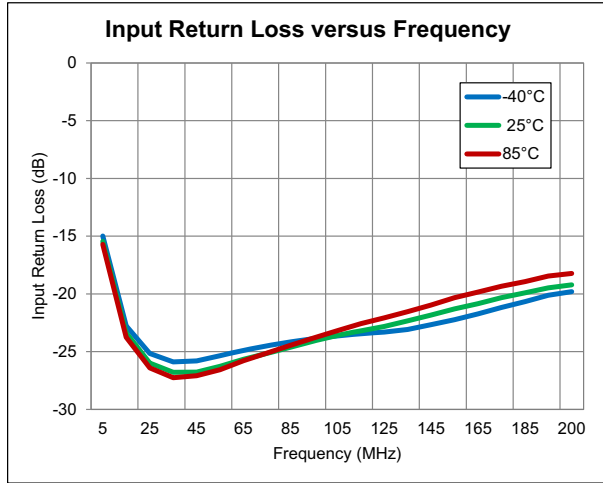

Performance Upstream Application Circuit $V_{CC} = 8.5V$, $I_{CC} = 147mA$

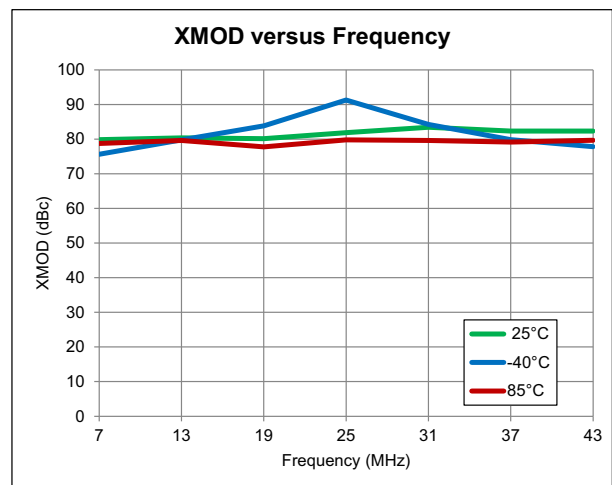
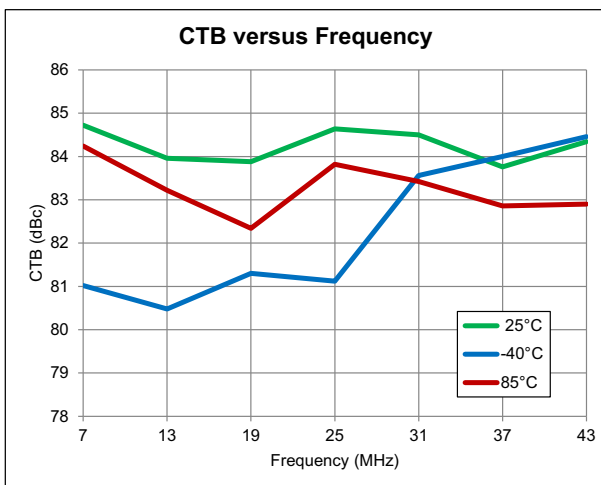
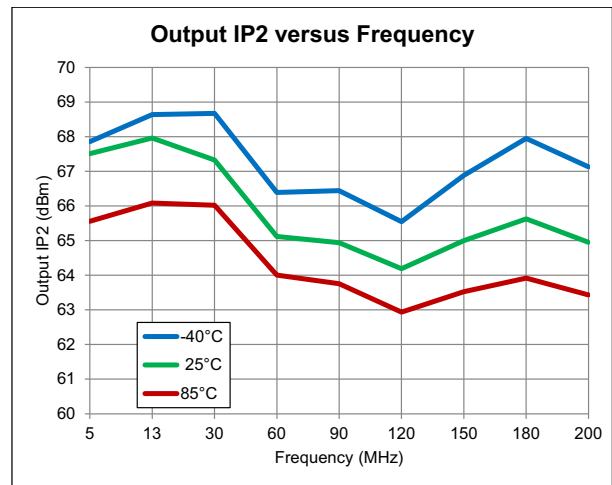
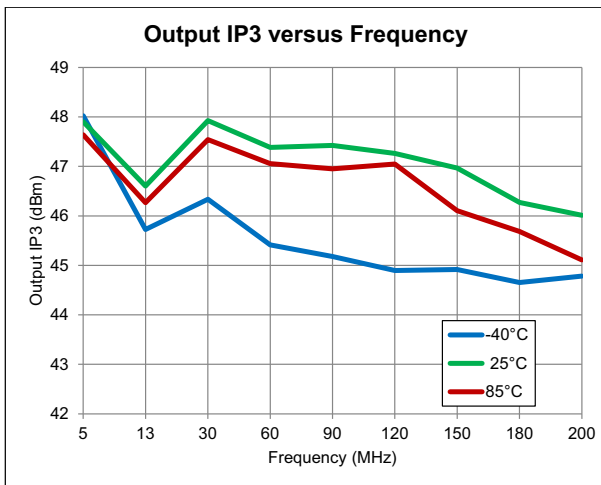
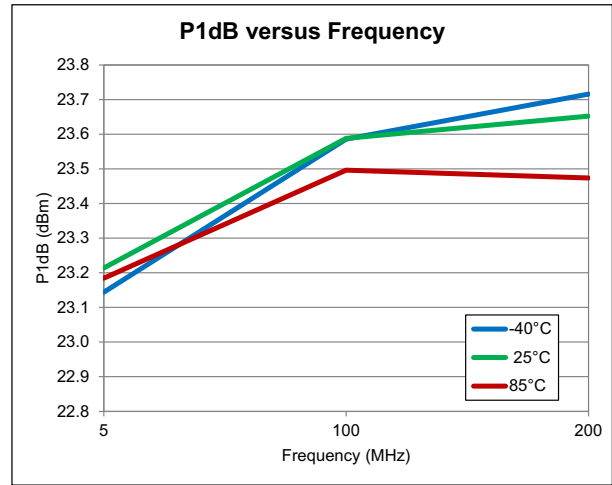
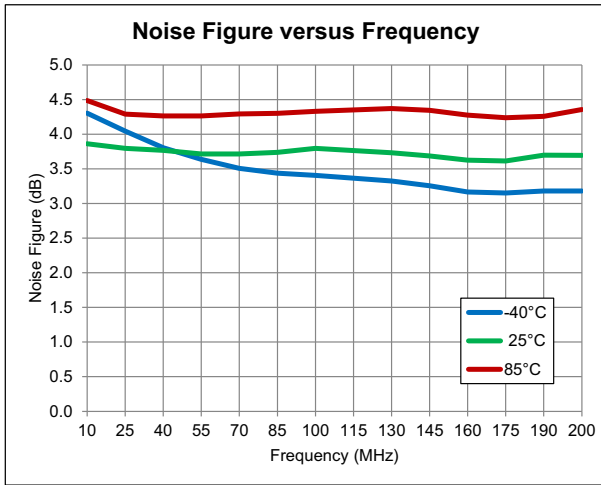

Performance Upstream Application Circuit $V_{CC} = 8.5V$, $I_{CC} = 147mA$

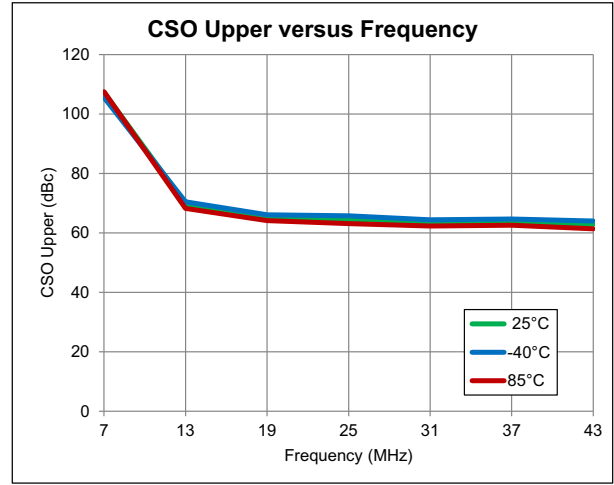
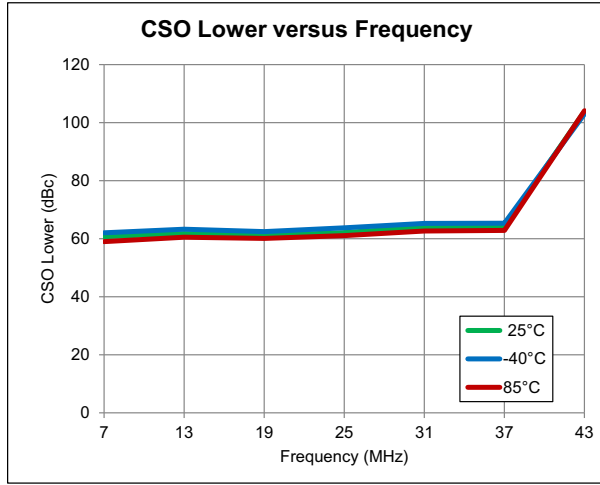

Evaluation Board Bill of Materials (BOM) Downstream Application Circuit (50MHz to 1000MHz)

Description	Reference Designator	Manufacturer	Manufacturer's P/N
Evaluation Board			RFCA3310410(A)
CONN, HDR, ST, PLRZD, 2-PIN, 0.100"	P1	ITW Panon	MPSS100-2-C
CONN, F FEM EDGE MOUNT, 75Ω, 0.068"	J1-J2	Millimeter Wave Technologies	MW-846-C-DD-75
IND, 1000nH, 5%, W/W, 0603	L1	Coilcraft	0603LS-102XJLC
RES, 0Ω, 0402	L2	Kamaya, Inc	RMC1/16SJPTH
IND, 6.8nH, 5%, M/L, 0402	L3	Toko America, Inc.	LL1005-FH6N8J
CAP, 1μF, 10%, 16V, X7R, 1206	C1	Panasonic Industrial Co	ECJ-3YB1C105K
CAP, 10000pF, 10%, 25V, X7R, 0402	C4-C5	Murata Electronics	GRM155R71E103KA01D
0.3pF, 0.1pF, 50, NPO, 0402, LF LEAD FREE	C6	Murata Electronics	GRM1555C1HR30BZ01D
CAP, 0.5pF, +/-0.1pF, 50V, HI-Q, 0402	C8	Murata Electronics	GJM1555C1HR50BB01D
CAP, 1200pF, 10%, 25V, X7R, 0402	C3	Panasonic Industrial Co	ECJ-0EB1E122K
RES, 1Ω, 5%, 1/16W, 0402	R1	Kamaya, Inc	RMC1/16S-1R0JTH
General Purpose Amplifier	U1	RFMD	RFCA3310

Downstream Evaluation Board Schematic

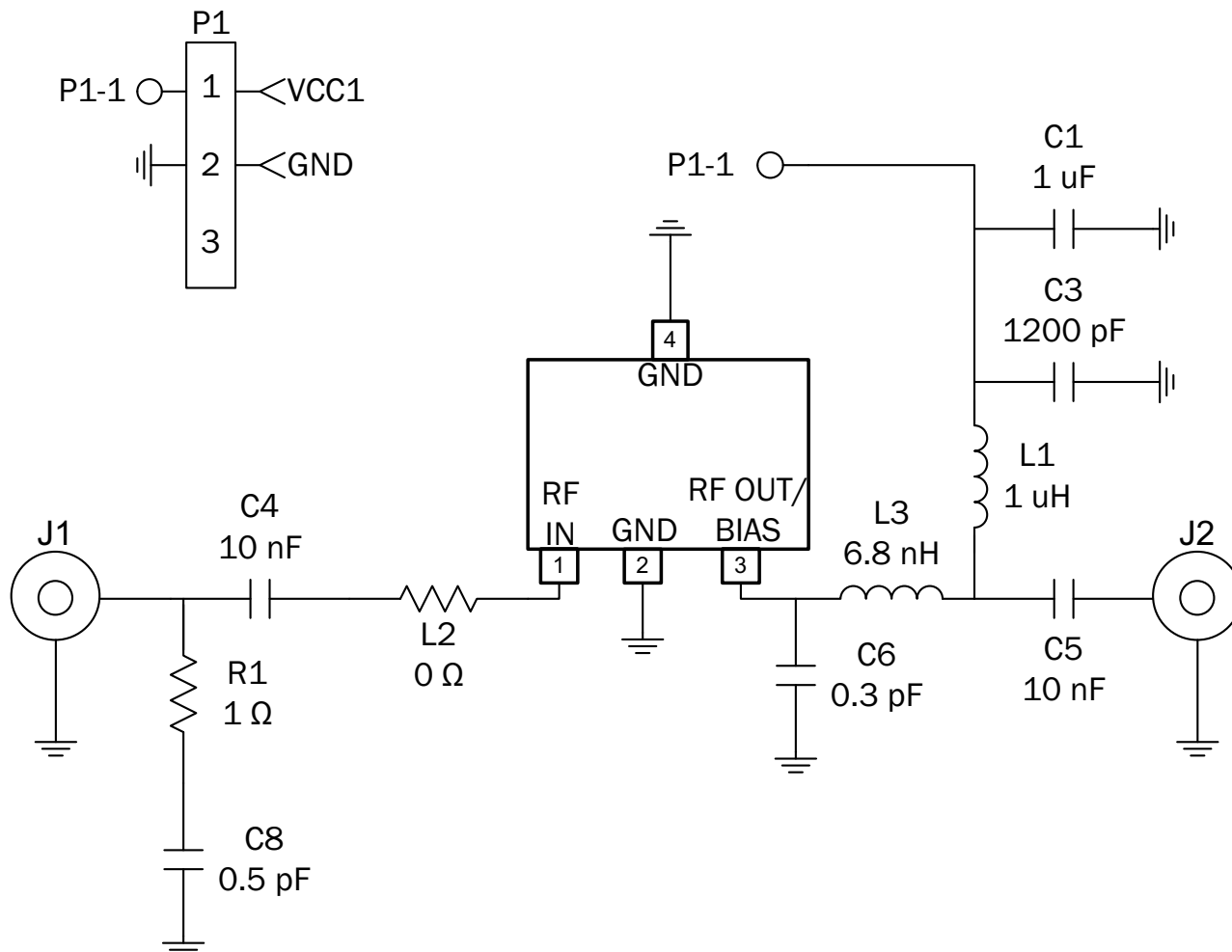

Evaluation Board Bill of Materials (BOM)

Upstream Application Circuit (5MHz to 200MHz)

Description	Reference Designator	Manufacturer	Manufacturer's P/N
Evaluation Board			RFCA3310410(A)
CONN, HDR, ST, PLRZD, 2-PIN, 0.100"	P1	ITW Panon	MPSS100-2-C
CONN, F FEM EDGE MOUNT, 75Ω, 0.068"	J1-J2	Millimeter Wave Technologies	MW-846-C-DD-75
IND, 3.9uH, 5%, 420mA, W/W, 1008	L1	Coilcraft	1008LS-392XJLB
RES, 0Ω, 0402	L2	Kamaya, Inc	RMC1/16SJPTH
IND, 6.8nH, 5%, M/L, 0402	L3	Toko America, Inc.	LL1005-FH6N8J
CAP, 1μF, 10%, 16V, X7R, 1206	C1	Panasonic Industrial Co	ECJ-3YB1C105K
0.3pF, 0.1pF, 50, NPO, 0402, LF LEAD FREE	C6	Murata Electronics	GRM1555C1HR30BZ01D
CAP, 1pF, +/-0.1pF, 50V, COG, 0402	C8	Murata Electronics	GRM1555C1H1R0BZ01D
CAP, 15000pF, 10%, 16V, X7R, 0402	C4-C5	Murata Electronics	GRM155R71C153KA01E
CAP, 1200pF, 10%, 25V, X7R, 0402	C3	Panasonic Industrial Co	ECJ-0EB1E122K
RES, 1Ω, 5%, 1/16W, 0402	R1	Kamaya, Inc	RMC1/16S-1R0JTH
General Purpose Amplifier	U1	RFMD	RFCA3310

Upstream Evaluation Board Schematic

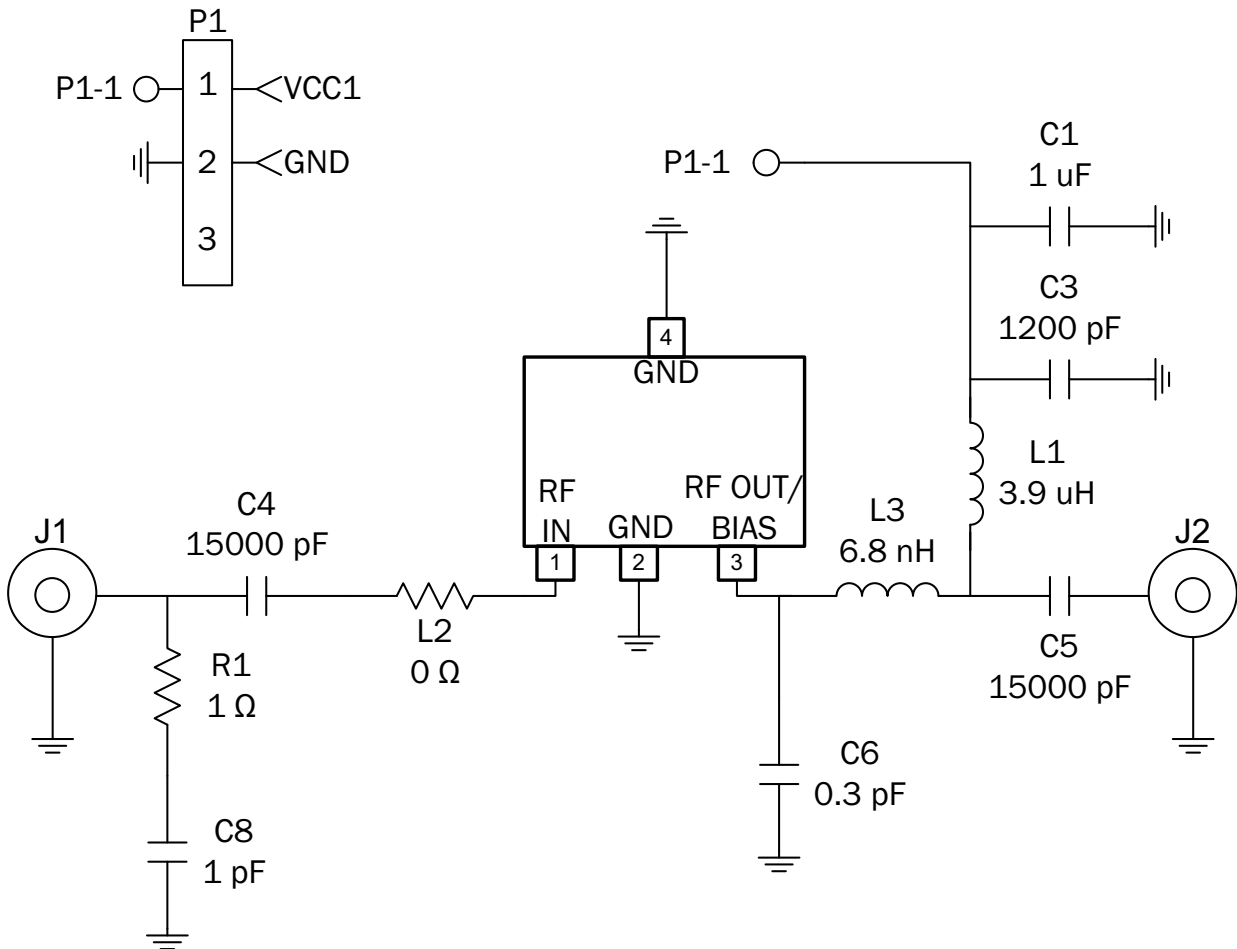

Pin Names and Descriptions

Pin	Name	Description
1	RF IN	RF Input, External DC-blocking Capacitor is Required
2	GND	DC and RF Ground
3	RF OUT / VCC	RF Output, Device Collector
4	GND	DC and RF Ground. Must be soldered to EVB ground plane over a bed of vias for thermal and RF performance.

Evaluation Board Assembly Drawing

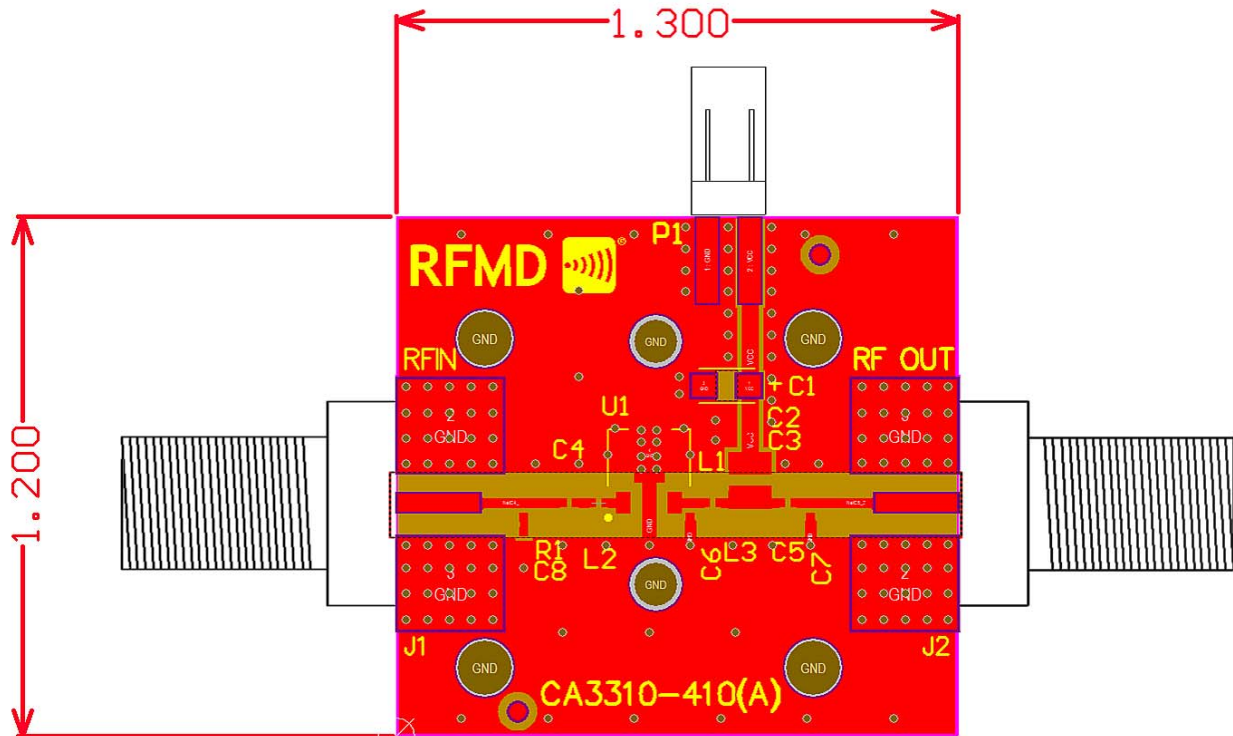

Package Drawing
Dimensions in Inches [Millimeters]

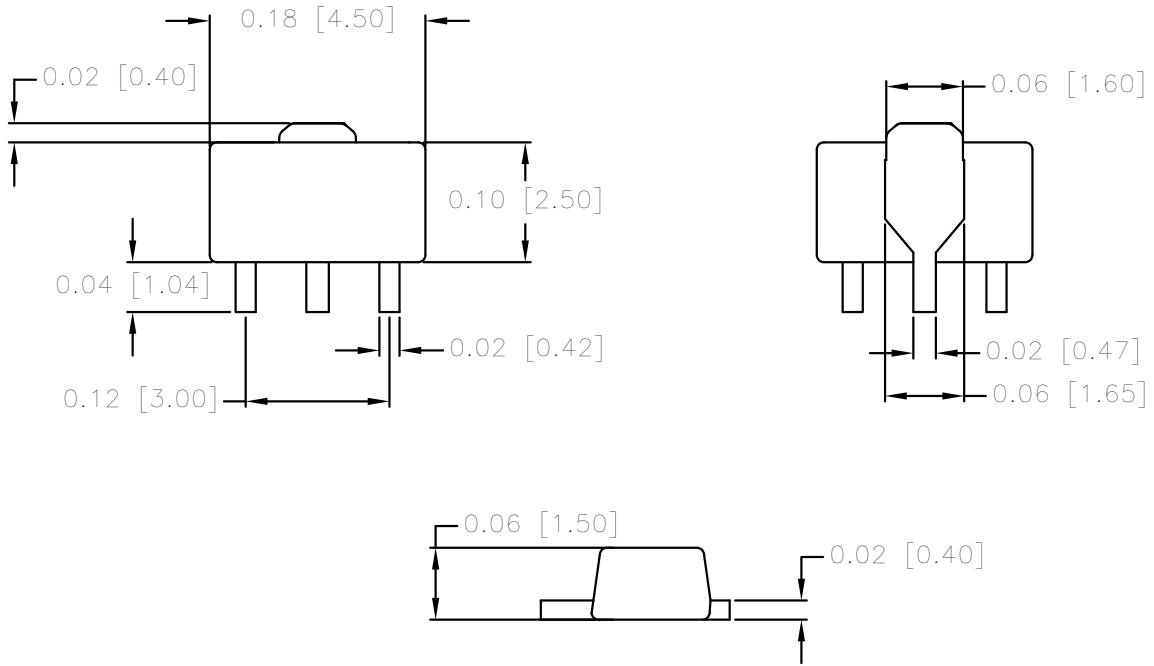

Branding Diagram

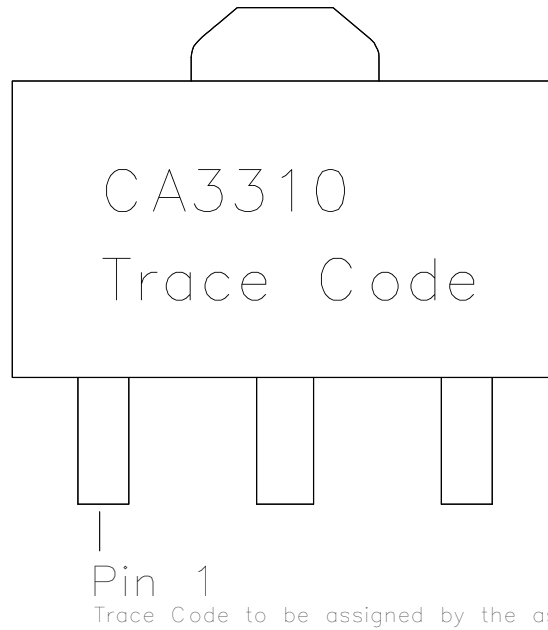

X-ON Electronics

Largest Supplier of Electrical and Electronic Components

Click to view similar products for [RF Amplifier](#) category:

Click to view products by [Qorvo](#) manufacturer:

Other Similar products are found below :

[A82-1](#) [BGA622H6820XTSA1](#) [BGA 728L7 E6327](#) [BGB719N7ESDE6327XTMA1](#) [HMC397-SX](#) [HMC405](#) [HMC561-SX](#) [HMC8120-SX](#)
[HMC8121-SX](#) [HMC-ALH382-SX](#) [HMC-ALH476-SX](#) [SE2433T-R](#) [SMA3101-TL-E](#) [SMA39](#) [A66-1](#) [A66-3](#) [A67-1](#) [LX5535LQ](#) [LX5540LL](#)
[MAAM02350](#) [HMC3653LP3BETR](#) [HMC549MS8GETR](#) [HMC-ALH435-SX](#) [SMA101](#) [SMA32](#) [SMA411](#) [SMA531](#) [SST12LP19E-QX6E](#)
[WPM0510A](#) [HMC5929LS6TR](#) [HMC5879LS7TR](#) [HMC1126](#) [HMC1087F10](#) [HMC1086](#) [HMC1016](#) [SMA1212](#) [MAX2689EWS+T](#)
[MAAMSS0041TR](#) [MAAM37000-A1G](#) [LTC6430AIUF-15#PBF](#) [CHA5115-QDG](#) [SMA70-2](#) [SMA4011](#) [A231](#) [HMC-AUH232](#) [LX5511LQ](#)
[LX5511LQ-TR](#) [HMC7441-SX](#) [HMC-ALH310](#) [XD1001-BD-000V](#)