



Features

- 34dB Typical Gain Across Frequency Band
- $P_{OUT} = 25\text{dBm} < 2.5\%$ Dynamic EVM
- 2.4GHz to 2.5GHz Frequency Range
- Integrated Three-Stage PA, Filtering and T/R switch
- High Impedance Control Integrated Power Detector

Applications

- WiFi IEEE802.11b/g/n Applications
- Customer Premises Equipment (CPE)
- Spread-Spectrum and MMDS Systems

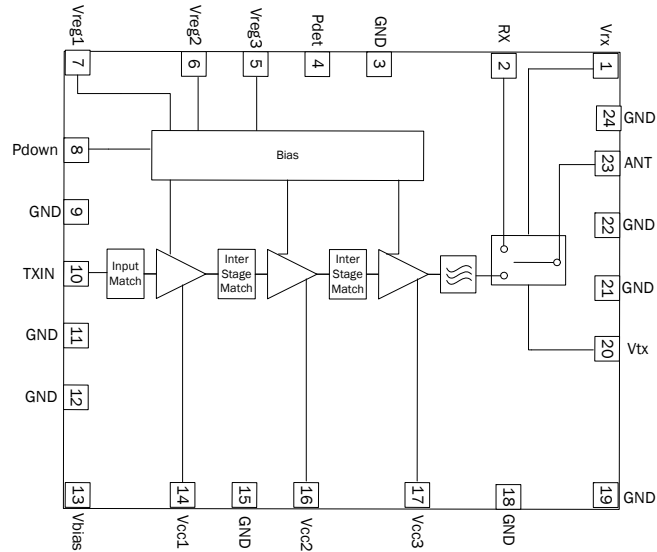

Functional Block Diagram

Product Description

RFFM4201 is a 1 x 1 MIMO module that is intently specified to address IEEE 802.11b/g/n WiFi 2.4GHz to 2.5GHz customer premises equipment (CPE) applications. The module has an integrated three-stage linear power amplifier, Tx harmonic filtering and SPDT switch. The RFFM4201 has fully matched input and output for a 50Ω system and incorporates matching networks optimized for linear output power and efficiency. The RFFM4201 is housed in a 6mm x 6mm laminate.

Ordering Information

RFFM4201PCK-410	RFFM4201 Eval Board and 5-Piece Bag
RFFM4201SB	5-Piece Bag
RFFM4201SR	100-Piece Reel
RFFM4201TR7	2500-Piece Reel
RFFM4201SQ	25-Piece Bag

Optimum Technology Matching® Applied

- | | | | |
|---|--------------------------------------|--|------------------------------------|
| <input type="checkbox"/> GaAs HBT | <input type="checkbox"/> SiGe BiCMOS | <input checked="" type="checkbox"/> GaAs pHEMT | <input type="checkbox"/> GaN HEMT |
| <input type="checkbox"/> GaAs MESFET | <input type="checkbox"/> Si BiCMOS | <input type="checkbox"/> Si CMOS | <input type="checkbox"/> BiFET HBT |
| <input checked="" type="checkbox"/> InGaP HBT | <input type="checkbox"/> SiGe HBT | <input type="checkbox"/> Si BJT | |

RF MICRO DEVICES®, RFMD®, Optimum Technology Matching®, Enabling Wireless Connectivity™, PowerStar®, POLARIS™ TOTAL RADIO™ and UltimateBlue™ are trademarks of RFMD, LLC. BLUETOOTH is a trademark owned by Bluetooth SIG, Inc., U.S.A. and licensed for use by RFMD. All other trade names, trademarks and registered trademarks are the property of their respective owners. ©2012, RF Micro Devices, Inc.

Absolute Maximum Ratings

Parameter	Rating	Unit
Supply Voltage (RF Applied)	-0.5 to +5.25	V
Supply Voltage (No RF Applied)	-0.5 to +6.0	V
DC Supply Current	750	mA
Input RF Power	+10*	dBm
Operating Temperature	-30 to +85	°C
Storage Temperature	-40 to +150	°C
Moisture Sensitivity	MSL3	

*Maximum Input Power with a 50Ω load.



Caution! ESD sensitive device.

Exceeding any one or a combination of the Absolute Maximum Rating conditions may cause permanent damage to the device. Extended application of Absolute Maximum Rating conditions to the device may reduce device reliability. Specified typical performance or functional operation of the device under Absolute Maximum Rating conditions is not implied.

The information in this publication is believed to be accurate and reliable. However, no responsibility is assumed by RF Micro Devices, Inc. ("RFMD") for its use, nor for any infringement of patents, or other rights of third parties, resulting from its use. No license is granted by implication or otherwise under any patent or patent rights of RFMD. RFMD reserves the right to change component circuitry, recommended application circuitry and specifications at any time without prior notice.



RFMD Green: RoHS compliant per EU Directive 2002/95/EC, halogen free per IEC 61249-2-21, < 1000ppm each of antimony trioxide in polymeric materials and red phosphorus as a flame retardant, and <2% antimony in solder.

Parameter	Specification			Unit	Condition
	Min.	Typ.	Max.		
Typical Conditions					T = 25 °C, V _{CC} = 5.0V, V _{REG} = 2.9V, using an IEEE802.11g waveform, 54Mbps, unless otherwise noted
Frequency	2412		2484	MHz	
Tx Performance - 11g/n					Compliance with standard 802.11g/n
802.11n Output Power	25	25.5		dBm	802.11n HT20 and HT40 MCS7
11n Dynamic EVM		2.5	3	%	
802.11n Output Power		25.8		dBm	At V _{CC} = 5.25V; 802.11n HT20 and HT40 MCS7
11n Dynamic EVM		2.5	3	%	
802.11g Output Power	25.5	26		dBm	802.11g 64QAM 54Mbps
11g Dynamic EVM		2.5	3	%	
Second Harmonic		-47	-42	dBm/MHz	11n HT40 MCS0/7. At rated P _{OUT}
Third Harmonic		-50	-42	dBm/MHz	11n HT40 MCS0/7. At rated P _{OUT}
Tx Performance - Spectral Mask					Compliance with standard 802.11b/n
802.11b Output Power		27.5		dBm	Meet 802.11b 1Mbps Mask Spec
802.11n Output Power		25		dBm	Meet 802.11n HT20/HT40 MCS7 Mask
Tx Performance - Generic					
Gain	31.5	34	37	dB	At rated P _{OUT}
Gain Variation over Temp			+/-2.5	dB	Over temperature of -40 °C to +85 °C
Low Gain Mode - Gain Reduction		23		dB	Drop in gain versus high gain mode by setting V _{REG2} = 0
Power Detect Range	0.125		2.3	V	P _{OUT} = 5dBm to 30dBm
Power Detect Voltage		1.45		V	At rated P _{OUT}
Input Return Loss - TX_IN pin	10	15		dB	In specified frequency band
Output Return Loss at ANT pin	6	8		dB	In specified frequency band
Operating Current		435	500	mA	At rated P _{OUT}
Quiescent Current		160	210	mA	V _{CC} = 5.0, V _{REG} = 2.9V and RF = OFF
PAE (Power Added Efficiency)		20		%	At rated P _{OUT} (PA only)
I _{REG}		4	8.5	mA	in Tx mode
P _{DOWN} Current - V _{REG} supply		7	10	mA	P _{DOWN} = 0V, V _{REG} = 2.9V, V _{CC} = 5V
P _{DOWN} Current - V _{CC} Supply		0.5	1	mA	P _{DOWN} = 0V, V _{REG} = 2.9V, V _{CC} = 5V
Leakage Current		0.2	0.6	mA	V _{CC} = 5V, V _{REG} = 0V, P _{DOWN} = 0V
Power Supply - V _{CC}		5	5.25	V	

Parameter	Specification			Unit	Condition
	Min.	Typ.	Max.		
Typical Conditions (continued)					
Power Supply - V_{REG1} , V_{REG2} , V_{REG3}	2.8	2.9	3	V	
Turn-on time from setting of V_{REG1} , V_{REG2} , V_{REG3}			400	ns	Output stable to within 90% of final gain
Turn-off time from setting of V_{REG1} , V_{REG2} , V_{REG3}			800	ns	Output stable to within 90% of final gain
Stability	-25		30	dBm	No spurs above -47dBm into 4:1 VSWR
CW P1dB		32		dBm	Tx mode in 50% Duty Cycle
Rx Performance					
Rx Insertion Loss - RX		0.8	1	dB	
Noise Figure		0.8	1	dB	In specified frequency band
Return Loss - RX	10	16		dB	
RX to Ant Isolation while in Tx Mode		30		dB	
RX to TX Isolation while in Tx Mode	25	30		dB	
Generic Performance					
T/R Switching Time			0.5	μ s	
Voltage Logic High	2.75	2.9	3.4	V	
Voltage Logic Low	0		0.3	V	
Control Current - Logic High		1	10	μ A	
Thermal					
R_{THJ}		30		$^{\circ}$ C/W	
ESD					
Human Body Model	250			V	EIA/JESD22-114A RF pins
	500			V	EIA/JESD22-114A DC pins
Charge Device Model	500			V	JESD22-C101C all pins

Truth Table			
Status	PDOWN	VTX	VRX
Tx Mode	1	1	0
Rx Mode	0	0	1

Pin Names and Descriptions

Pin	Name	Description
1	VRX	Switch control for Rx mode
2	RX	RF output is internally matched to 50Ω and DC blocked.
3	GND	Ground connection
4	PDET	Power detector provides an output voltage proportional to the RF output power level.
5	VREG3	Third stage bias voltage. This pin requires regulated supply for best performance.
6	VREG2	Second stage bias voltage. This pin requires regulated supply for best performance.
7	VREG1	First stage bias voltage. This pin requires regulated supply for best performance.
8	PDOWN	Power down pin. Apply <math><0.3V_{DC}</math> to power down the three power amplifier stages. Apply $1.75V_{DC}$ to $5.0V_{DC}$ to power up. If function is not desired, pin may be connected to VREG.
9	GND	Ground connection
10	TXIN	RF input is internally matched to 50Ω and DC blocked.
11	GND	Ground connection
12	GND	Ground connection
13	VBIAS	Supply voltage for the bias reference and control circuits.
14	VCC1	This pin is connected internally to the collector of the 1st stage RF device. To achieve specified performance, the layout of these pins should match the recommended land pattern.
15	GND	Ground connection
16	VCC2	This pin is connected internally to the collector of the 2nd stage RF device. To achieve specified performance, the layout of these pins should match the recommended land pattern.
17	VCC3	This pin is connected internally to the collector of the 3rd stage RF device. To achieve specified performance, the layout of these pins should match the recommended land pattern.
18	GND	Ground connection
19	GND	Ground connection
20	VTX	Switch control for Tx mode
21	GND	Ground connection
22	GND	Ground connection
23	ANT	RF Output is internally matched to 50Ω and DC blocked.
24	GND	Ground connection
PkG Base	GND	Ground connection

Theory of Operation and Applications

The RFFM4201 is a single-chip integrated front end module (FEM) for high performance WiFi applications in the 2.4GHz to 2.5GHz ISM band. The FEM greatly reduces the number of external components minimizing footprint and assembly cost of the overall 802.11b/g/n solution. The RFFM4201 has an integrated b/g/n power amplifier, a power Detector, and Tx filtering and a switch, which is capable of switching between WiFi Rx, WiFi Tx operations. The device is manufactured using InGaP HBT and pHEMT processes on a 6mm x 6mm x 0.95mm laminate package. The module meets or exceeds the RF front end needs of the 802.11b/g/n WiFi RF systems. The RFFM4201 is a very easy part to implement. To reduce the design and optimization process on the customer application, the evaluation board layout should be copied as close as possible, in particular the ground and via configurations. Gerber files of RFMD PCBA designs will be provided upon request. The supply voltage lines should present an RF short to the FEM by using bypass capacitors on the V_{CC} traces. To simplify bias conditions, the RFFM4201 requires a single positive supply voltage (V_{CC}), a positive current control bias (V_{REG}) supply, and a positive supply for switch control. The built-in power detector of the RFFM4201 can be used as power monitor in the system. All inputs and outputs are internally matched to 50 Ω .

Transmit Path

The RFFM4201 has a typical gain of 34dB from 2.4GHz to 2.5GHz, and delivers 25.5dBm typical output power in 11n HT20 MCS7 and 26dBm typical in 11g 54Mbps. The RFFM4201 requires a single positive of 5.0V to operate at full specifications. The VREG pin requires a regulated supply at 2.9V to maintain nominal bias current.

Out of Band Rejection

The RFFM4201 contains a low pass filtering (LPF) to attenuate the 2nd Harmonics to -47dBm/MHz (typical), to meet the out of band rejection requirements of the system for FCC specification.

Receive Path

The Rx path has a 50 Ω single-ended port. The receive port return loss is 9.6dB minimum. In this mode, the FEM has an Insertion loss of 0.8dB and 30dB (typical) isolation to Tx port.

RFFM4201 Biasing Instructions to the Evaluation Board:

- 802.11b/g/n transmit:
- Connect the FEM to a signal generator at the input and a spectrum analyzer at the output. Set the pin at signal generator is at -20dBm.
- Bias V_{CC} to 5.0V first with $V_{REG} = 0.0V$. If available, enable the current limiting function of the power supply to 750mA.
- Refer to switch operational truth table to set the control lines at the proper levels for WiFi Tx.
- Turn on V_{REG} to 2.9V (typ.).
On V_{REG} (of evaluation board), regulated supply is recommended. Be extremely careful not to exceed 3.0V on the VREG pin or the part may exceed device current limits.
- Turn on P_{DOWN} to 2.9V (typ.). P_{DOWN} pin can be tied to V_{REG} supply.
NOTE: It is important to adjust the V_{CC} voltage source so that +5V is measured at the board; and the +2.9V of V_{REG} is measured at the board. The high collector currents will drop the collector voltage significantly if long leads are used. Adjust the bias voltage to compensate.
- Turn on RF of signal generator and gradually increase power level to the rated power.
CAUTION: If the input signal exceeds the rated power, the RFFM4201 Evaluation Board can be permanently damaged.
- To turn off FEM, turn off RF power of signal generator; then P_{DOWN} , V_{REG} and V_{CC} .
- 802.11b/g/n receive
- To receive WiFi set the switch control lines per the truth table.

General Layout Guidelines and Considerations:

For best performance the following layout guidelines and considerations must be followed regardless of final use or configuration:

1. The ground pad of the RFFM4201 has special electrical and thermal grounding requirements. This pad is the main RF ground and main thermal conduit path for heat dissipation. The GND pad and vias pattern and size used on the RFMD evaluation board should be replicated. The RFMD layout files in Gerber format can be provided upon request. Ground paths (under device) should be made as short as possible.
2. The RF lines should be well separated with solid ground in between the traces to eliminate any possible RF leakages or cross-talking.
3. Bypass capacitors should be used on the DC supply lines. The VCC lines may be connected after the RF bypass and decoupling capacitors to provide better isolation between each VCC line.

RFFM4201 Tx Production and System Calibration Recommendation:

It is highly recommended to follow the DC biasing step and RF power settings in the production calibration or test.

1. Connect the RF cables of input and output then connect to the proper equipment.
2. Apply V_{CC} , then V_{REG} as per the data sheet recommendations.
3. Set RF input to the desired frequency and initial RF input power at -20dBm. This will insure the power amplifier is in a linear state and not over driven.
4. Set FEM in Tx mode by the truth table.
5. Apply $P_{DOWN} = \text{high}$
6. Sweep RF from low to high output power and take measurements at the rated output power.
7. Ensure that the output power at turn on does not saturate the power amplifier. The recommended output power should be about 10dB to 20dB below the rated power. Start calibrating from low to high power in reasonable steps until the rated power is reached then take the measurements.

CAUTION: If the input signal exceeds the maximum input power specifications, the RFFM4201 could be permanently damaged.

Package Drawing

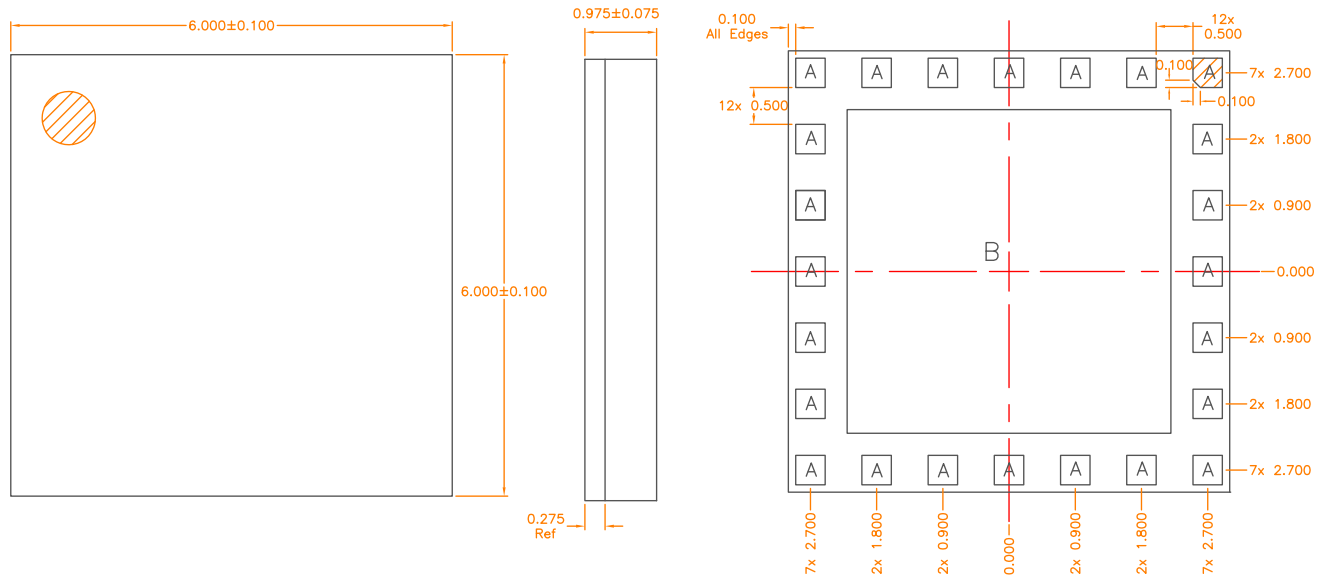

Notes:
1. Shaded area represents Pin 1 location.

A = 0.400 x 0.400 mm
B = 4.400 x 4.400 mm

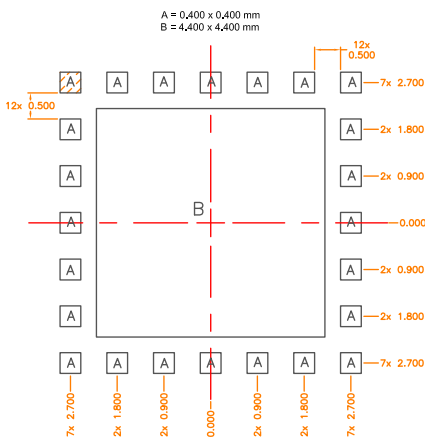

PCB Metal Land Pattern

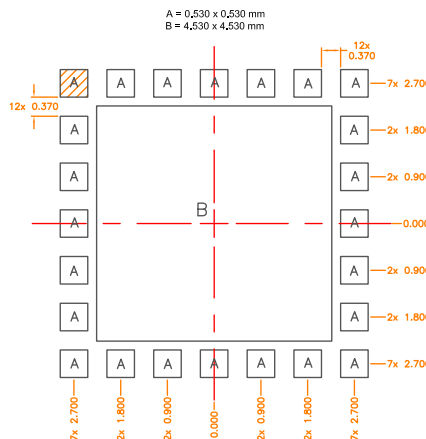

PCB Solder Mask Pattern

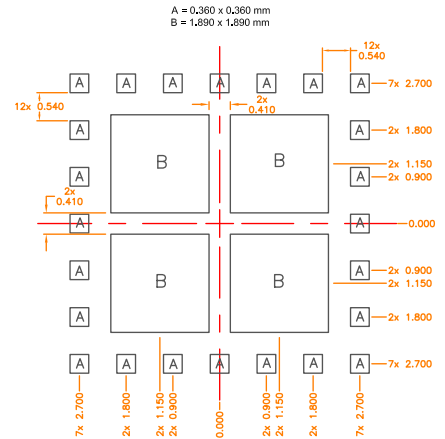

PCB Stencil Pattern

Notes:
1. Shaded area represents Pin 1 location.

Note: Thermal vias for center slug “B” should be incorporated into the PCB design. The number and size of thermal vias will depend on the application. Example of the number and size of vias can be found on the RFMD evaluation board layout.

Pin Out

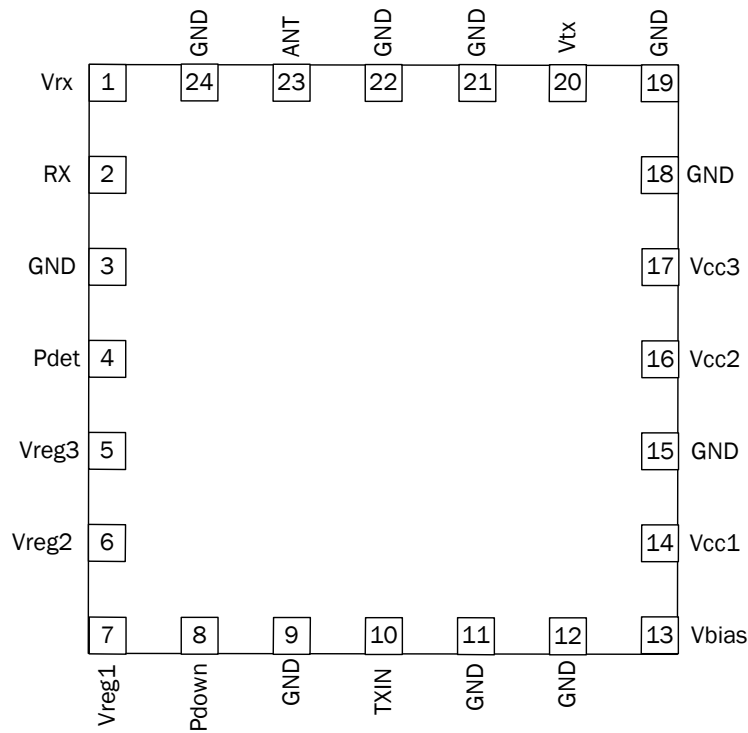

Evaluation Board

Top Layer

Bottom Layer

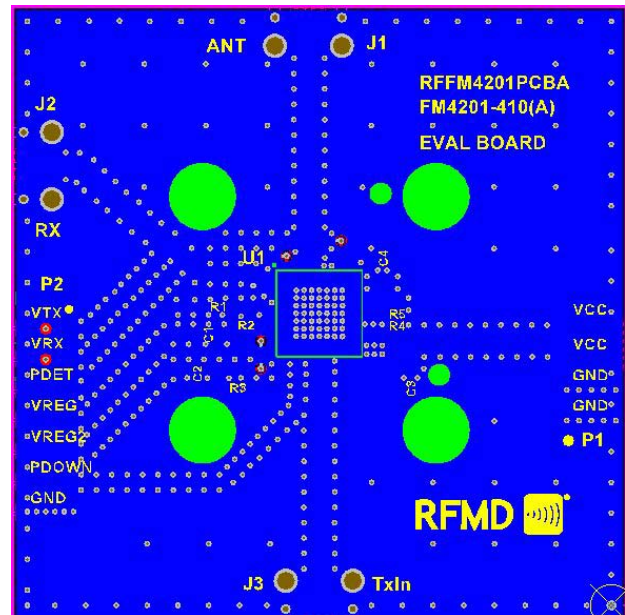
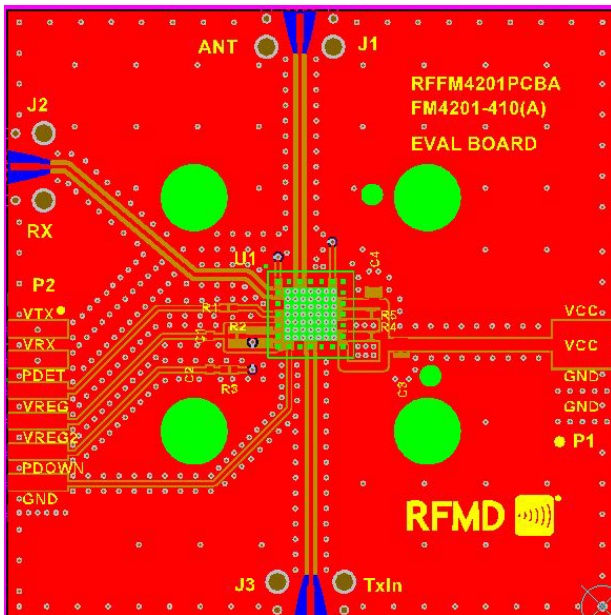

Evaluation Board Schematic

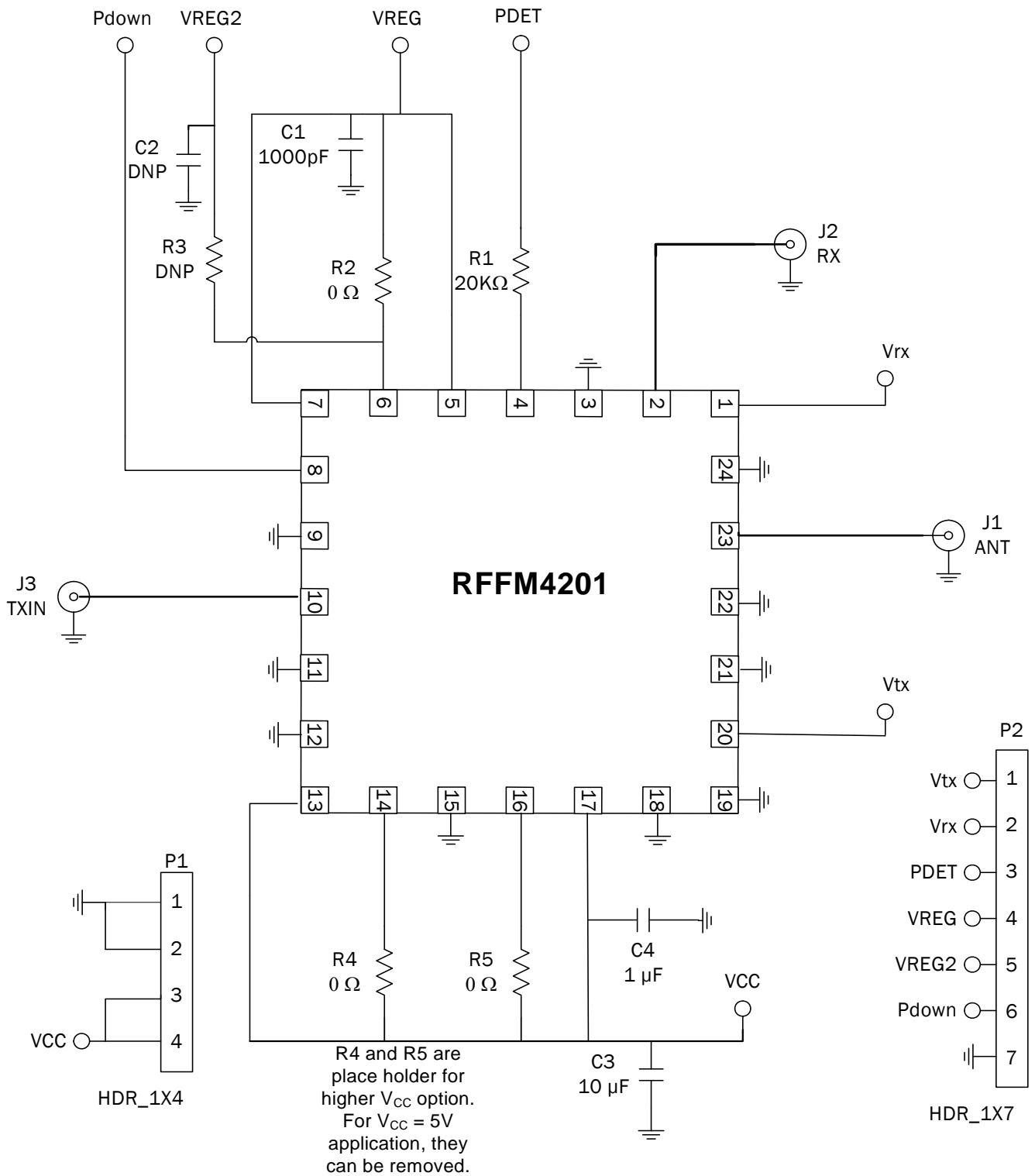

Bill of Materials

Description	Qty	Reference Designator	Manufacturer	Manufacturer's P/N
CAP, 1000pF, 10%, 50V, X7R, 0402	1	C1	Murata Electronics	GRM155R71H102KA01D
CAP, 1µF, 10%, 10V, X5R, 0603	1	C4	Murata Electronics	GRM188R61A105KA61D
CAP, 10µF, 10%, 10V, X5R, 0805	1	C3	Murata Electronics	RM21BR61A106KE19L
CONN, SMA, END LNCH, UNIV, HYB MNT, FLT	3	J1, J2, J3	MOLEX	SD-73251-4000
RES, 20K, 5%, 1/16W, 0402	1	R1	PANASONIC INDUSTRIAL CO	ERJ-2GEJ203
RES, 0Ω, 0402	3	R2, R4, R5	Kamaya, Inc	RMC1/16SJPTH
DNI	2	R3, C2		
RFFM4201	1	U1	RFMD	RFFM4201

WiFi 802.11n HT20 MCS7 Performance Plots in 100% Duty Cycle

EVM (%) versus P_{OUT} (dBm)
-40°C
V_{CC} = 5V_{DC} V_{REG} = 2.9V_{DC}

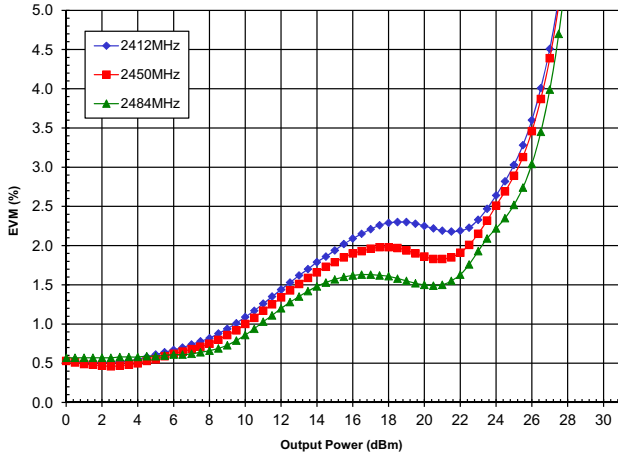

EVM (%) versus P_{OUT} (dBm)
25°C
V_{CC} = 5V_{DC} V_{REG} = 2.9V_{DC}

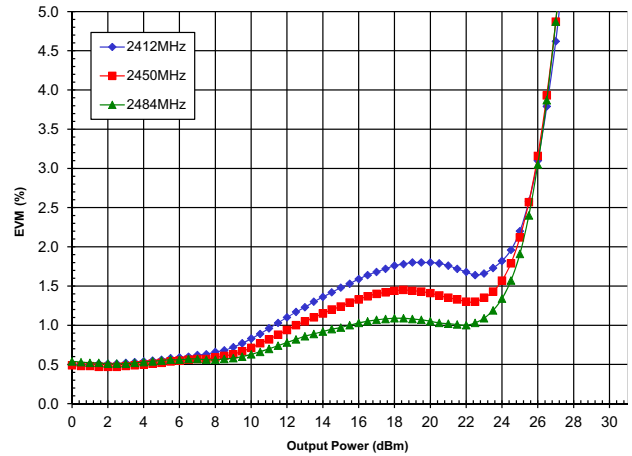

EVM (%) versus P_{OUT} (dBm)
85°C
V_{CC} = 5V_{DC} V_{REG} = 2.9V_{DC}

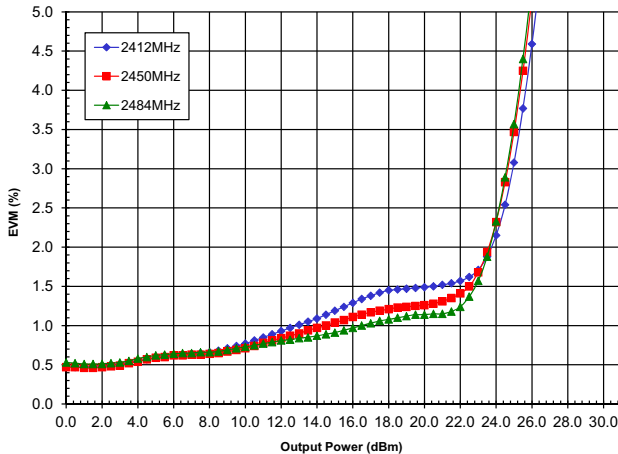

I_{CC} (A) versus P_{OUT} (dBm)
-40°C
V_{CC} = 5V_{DC} V_{REG} = 2.9V_{DC}

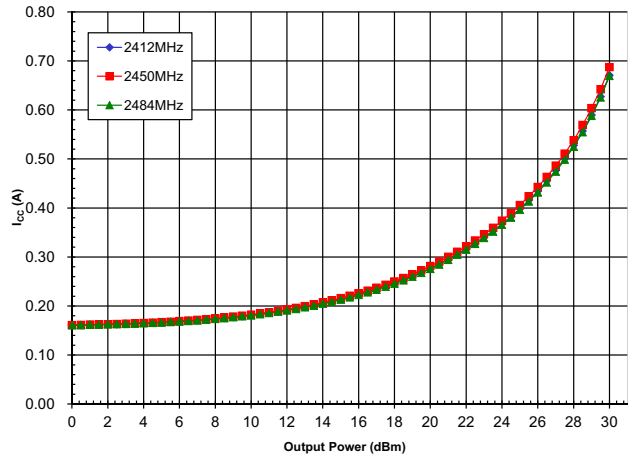

I_{CC} (A) versus P_{OUT} (dBm)
25°C
V_{CC} = 5V_{DC} V_{REG} = 2.9V_{DC}

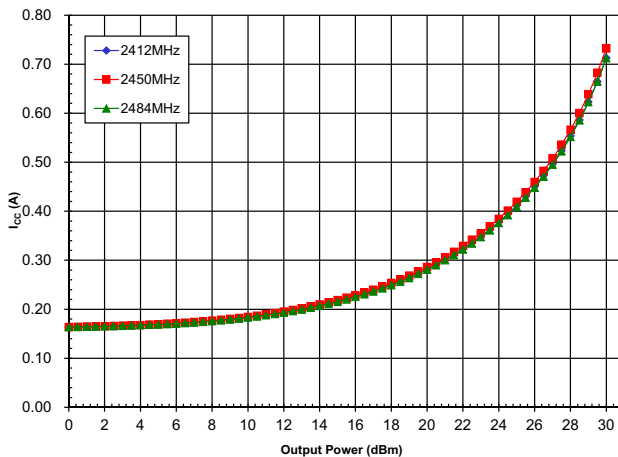

I_{CC} (A) versus P_{OUT} (dBm)
85°C
V_{CC} = 5V_{DC} V_{REG} = 2.9V_{DC}

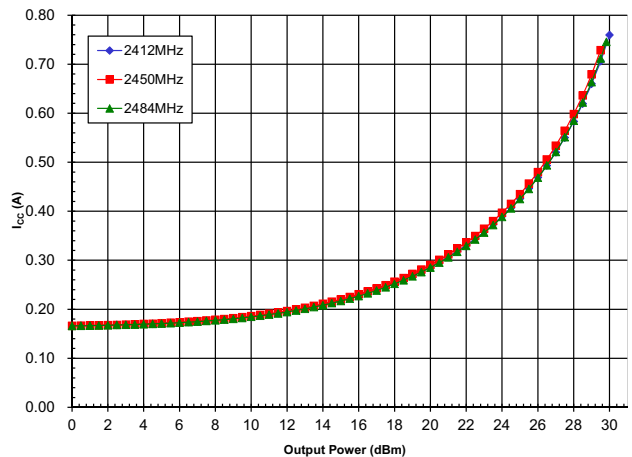

WiFi 802.11n HT20 MCS7 Performance Plots in 100% Duty Cycle

Gain (dB) versus P_{OUT} (dBm)
-40°C
 $V_{CC} = 5V_{DC}$ $V_{REG} = 2.9V_{DC}$

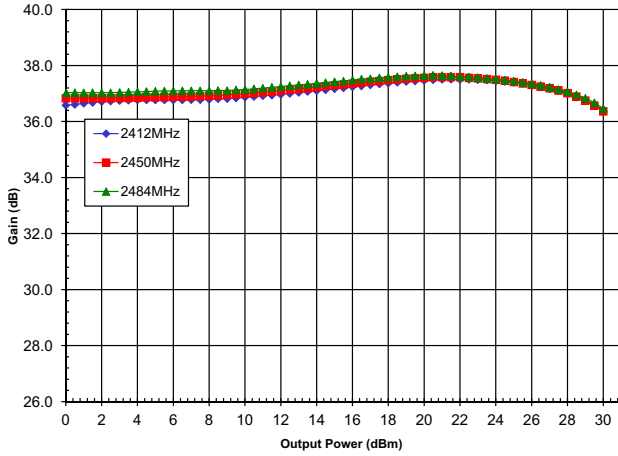

Gain (dB) versus P_{OUT} (dBm)
25°C
 $V_{CC} = 5V_{DC}$ $V_{REG} = 2.9V_{DC}$

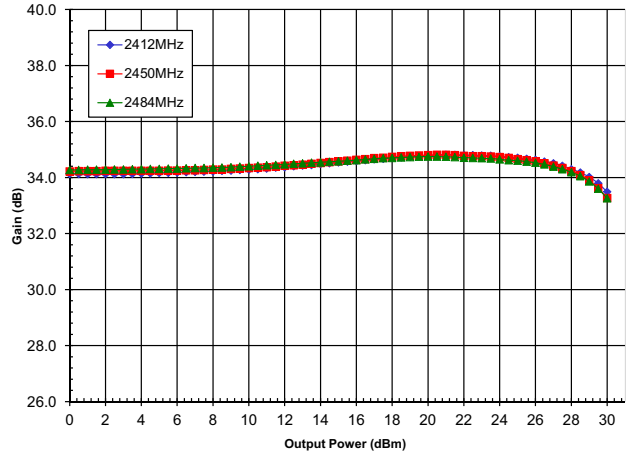

Gain (dB) versus P_{OUT} (dBm)
85°C
 $V_{CC} = 5V_{DC}$ $V_{REG} = 2.9V_{DC}$

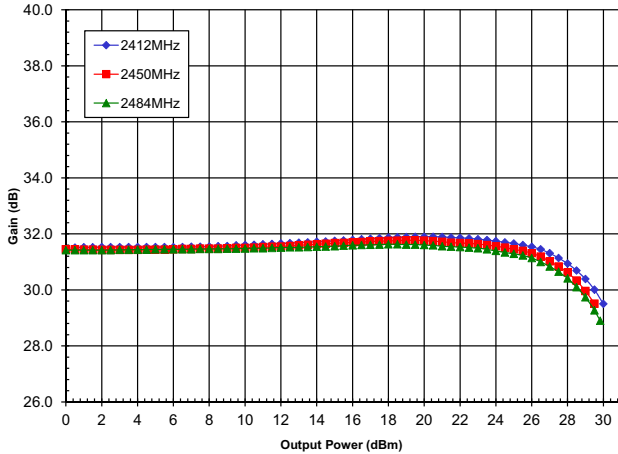

Power Detect (V) versus P_{OUT} (dBm)
-40°C
 $V_{CC} = 5V_{DC}$ $V_{REG} = 2.9V_{DC}$

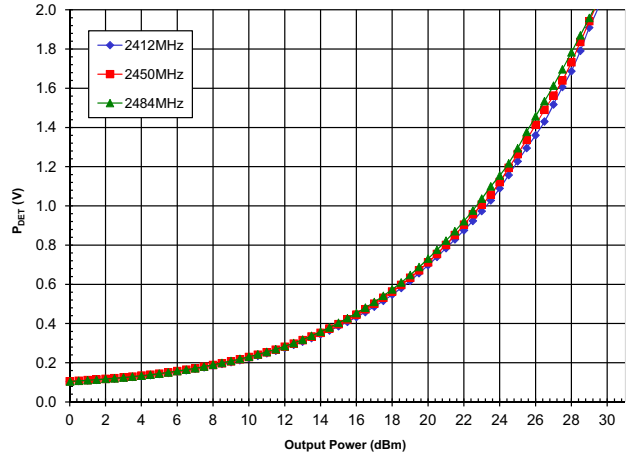

Power Detect (V) versus P_{OUT} (dBm)
25°C
 $V_{CC} = 5V_{DC}$ $V_{REG} = 2.9V_{DC}$

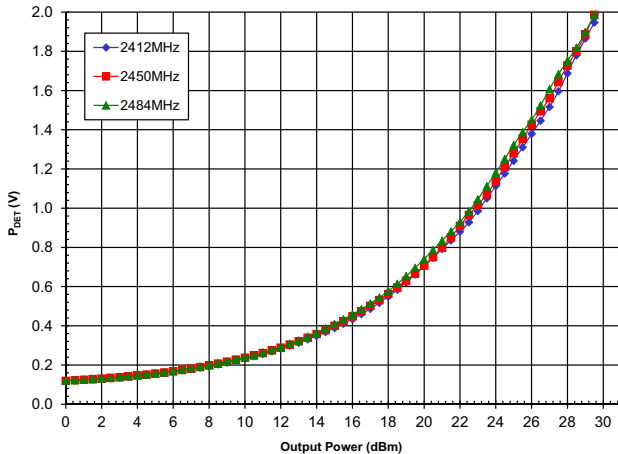

Power Detect (V) versus P_{OUT} (dBm)
85°C
 $V_{CC} = 5V_{DC}$ $V_{REG} = 2.9V_{DC}$

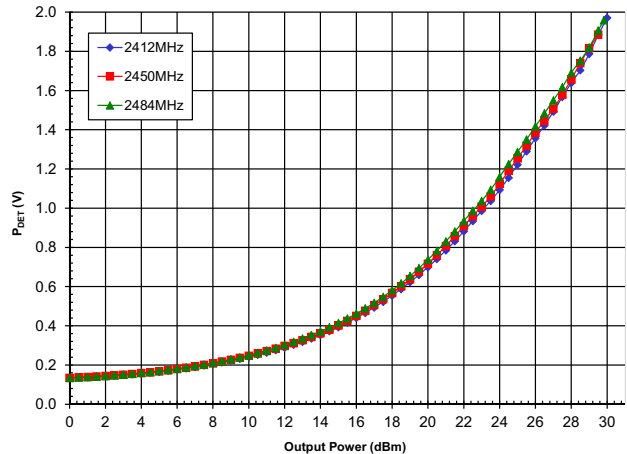

WiFi 802.11n HT20 MCS7 Performance Plots in 50% Duty Cycle

EVM (%) versus P_{OUT} (dBm)
-40°C
V_{CC} = 5V_{DC} V_{REG} = 2.9V_{DC}

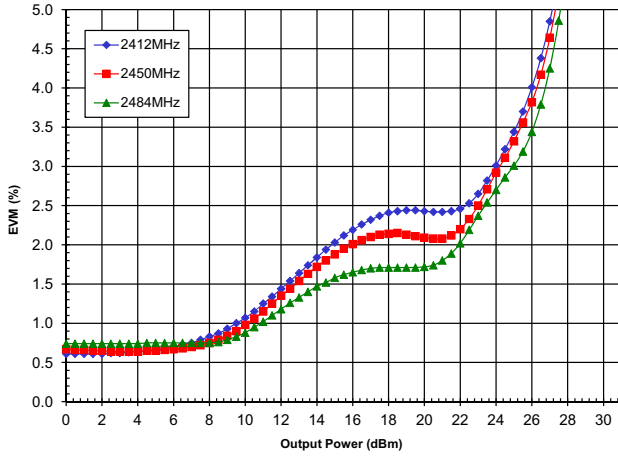

EVM (%) versus P_{OUT} (dBm)
25°C
V_{CC} = 5V_{DC} V_{REG} = 2.9V_{DC}

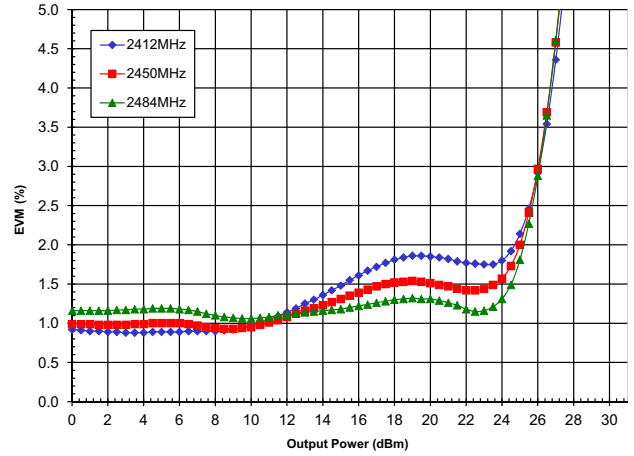

EVM (%) versus P_{OUT} (dBm)
85°C
V_{CC} = 5V_{DC} V_{REG} = 2.9V_{DC}

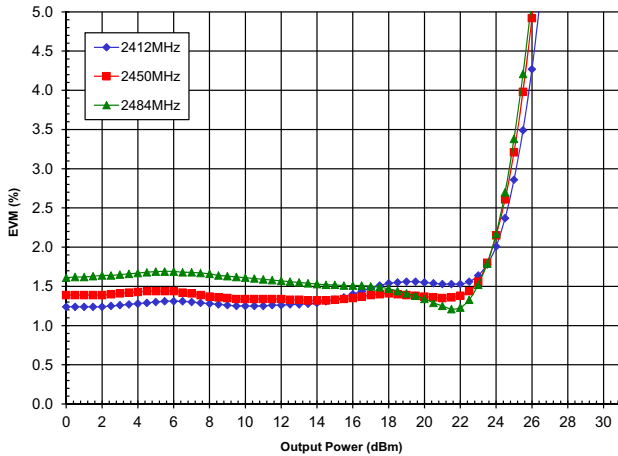

I_{CC} (A) versus P_{OUT} (dBm)
-40°C
V_{CC} = 5V_{DC} V_{REG} = 2.9V_{DC}

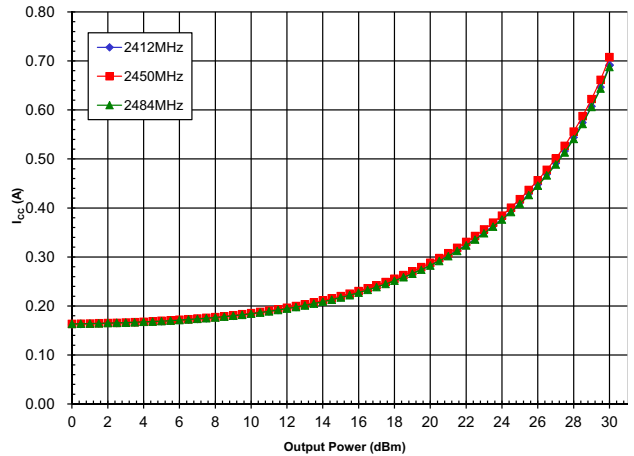

I_{CC} (A) versus P_{OUT} (dBm)
25°C
V_{CC} = 5V_{DC} V_{REG} = 2.9V_{DC}

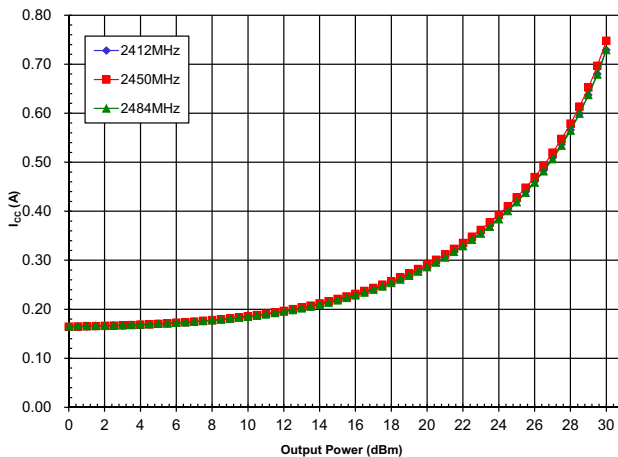

I_{CC} (A) versus P_{OUT} (dBm)
85°C
V_{CC} = 5V_{DC} V_{REG} = 2.9V_{DC}

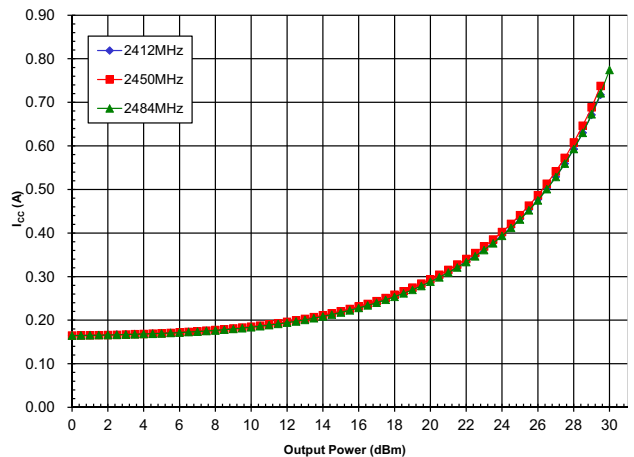

WiFi 802.11n HT20 MCS7 Performance Plots in 50% Duty Cycle

Gain (dB) versus P_{OUT} (dBm)
-40°C
 $V_{CC} = 5V_{DC}$ $V_{REG} = 2.9V_{DC}$

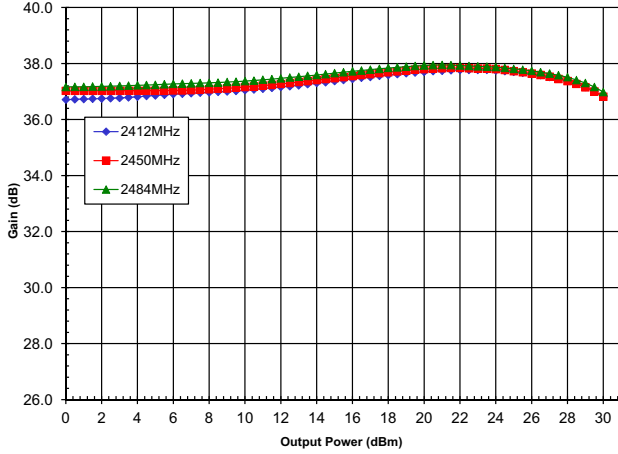

Gain (dB) versus P_{OUT} (dBm)
25°C
 $V_{CC} = 5V_{DC}$ $V_{REG} = 2.9V_{DC}$

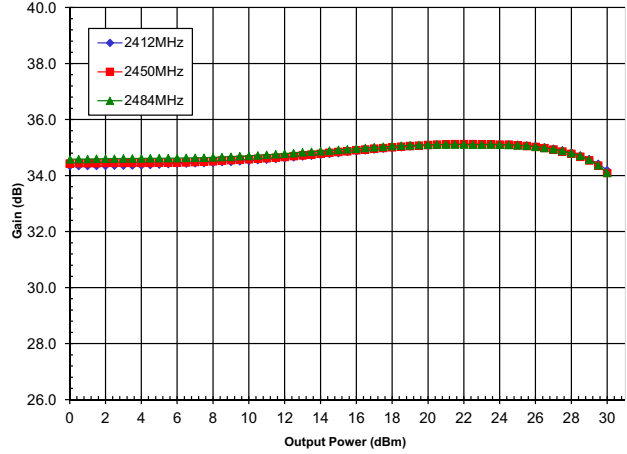

Gain (dB) versus P_{OUT} (dBm)
85°C
 $V_{CC} = 5V_{DC}$ $V_{REG} = 2.9V_{DC}$

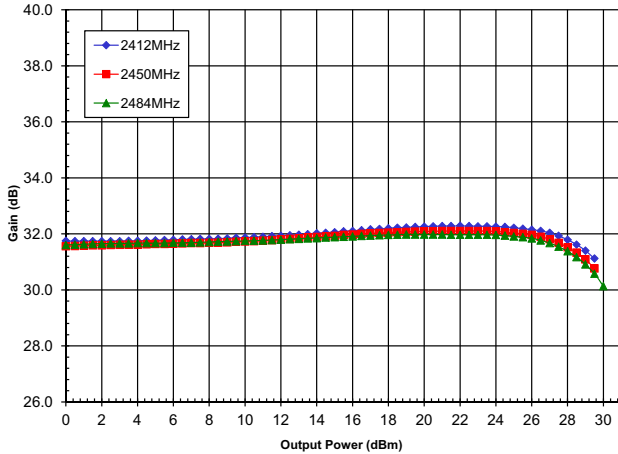

Power Detect (V) versus P_{OUT} (dBm)
-40°C
 $V_{CC} = 5V_{DC}$ $V_{REG} = 2.9V_{DC}$

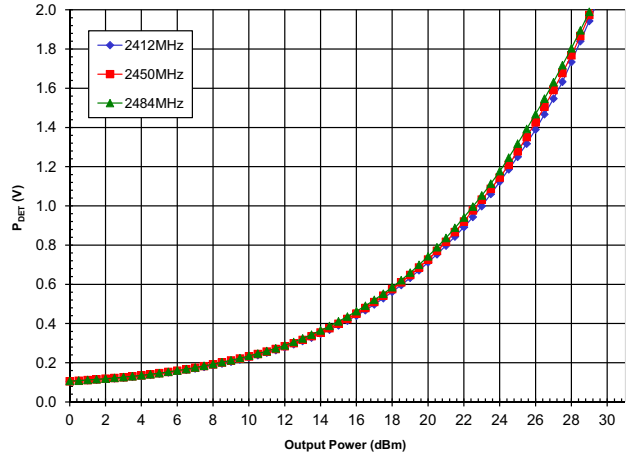

Power Detect (V) versus P_{OUT} (dBm)
25°C
 $V_{CC} = 5V_{DC}$ $V_{REG} = 2.9V_{DC}$

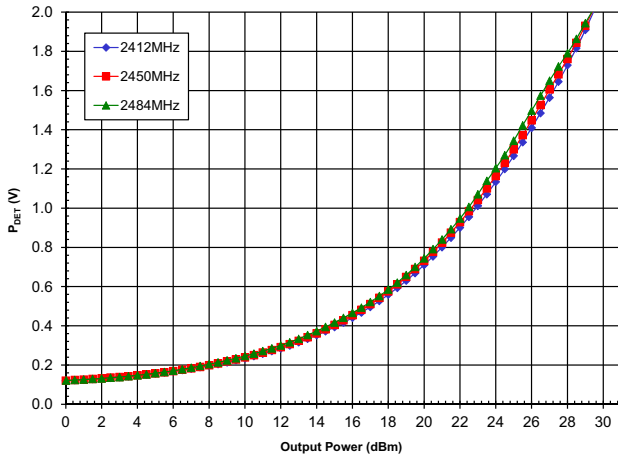

Power Detect (V) versus P_{OUT} (dBm)
85°C
 $V_{CC} = 5V_{DC}$ $V_{REG} = 2.9V_{DC}$

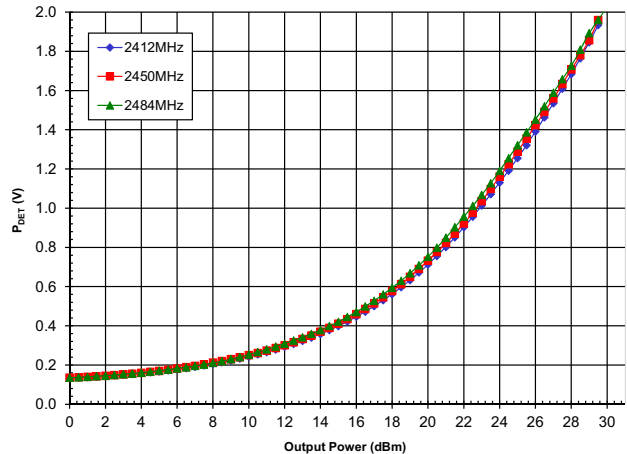

X-ON Electronics

Largest Supplier of Electrical and Electronic Components

Click to view similar products for [RF Front End](#) category:

Click to view products by [Qorvo](#) manufacturer:

Other Similar products are found below :

[SE2622L-R](#) [BGM1032N7E6327XUSA1](#) [LX5586LL](#) [LX5586HLL](#) [LX5586ALL](#) [SKY66111-21](#) [SKY65728-11](#) [SKY68000-31](#) [SKY85308-11](#)
[SKY85302-11](#) [SKY85300-21](#) [SKY65724-11](#) [ADTR1107ACCZ](#) [LMP91051MTX/NOPB](#) [SE5501L-R](#) [QPF4519SR](#) [SE5503A-R](#)
[ADA8282WBCPZ](#) [ADRF5545ABCPZN](#) [ADRF5545ABCPZN-R7](#) [AD8283WBCPZ](#) [AD8284WCSVZ](#) [ADRF5547BCPZN](#)
[ADRF5547BCPZN-R7](#) [ADRF5549BCPZN](#) [ADRF5549BCPZN-R7](#) [HV7350K6-G](#) [SE5516A-R](#) [MCP2030-I/SL](#) [MAX2009ETI+](#)
[MAX2078CTK+](#) [MAX2335ETI+](#) [MAX2678GTB/V+T](#) [MD2131K7-G](#) [MD2134K7-G](#) [RFFM4554SR](#) [RFFM4554TR7](#) [RFFM8504SR](#)
[RFFM8511SR](#) [RFFM4552TR7](#) [RFFM4503TR7](#) [RFFM6903TR13](#) [HV7351K6-G](#) [MCP2035-I/ST](#) [SE2614BT-R](#) [SE2438T-R](#) [SST12LF02-](#)
[QXCE](#) [SST12LF09-Q3CE](#) [RFX2401C](#) [RFX2402E](#)