



RFFM6903

ISM Front End Module

Product Overview

The Qorvo® RFFM6903 is a single-chip front end module (FEM) for applications in the 900MHz and 868MHz ISM Bands. The RFFM6903 addresses the need for aggressive size reduction for typical portable equipment RF front end design and greatly reduces the number of components outside of the core chipset thus minimizing the footprint and assembly cost of the overall solution.

The RFFM6903 contains an integrated 1 Watt PA, SP3T antenna switch, integrated Tx harmonic filter, Tx thru path, LNA with bypass mode, and matching components.



28 Pad 6x6 mm Laminate Package

Functional Block Diagram

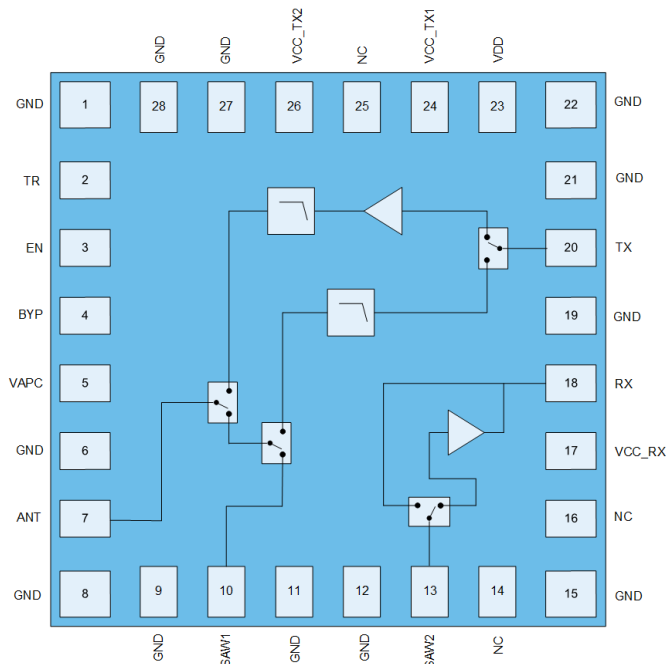

Top View

Key Features

- 890-960 MHz
- Integrated 50Ω Input/Output Match
- Tx Output Power: 30dBm
- Separate TX/RX 50Ω transceiver interface
- Integrated PA, filtering LNA with Bypass Mode
- Transmit Thru path

Applications

- Wireless Automatic Metering
- Portable Battery Powered Equipment
- Smart Energy

Ordering Information

Part Number	Description
RFFM6903SB	Sample bag with 5 pieces
RFFM6903SQ	Sample bag with 25 pieces
RFFM6903SR	7" reel with 100 pieces
RFFM6903TR13	13" reel with 2,500 pieces
RFFM6903PCK-410	Evaluation board w/ 5 pc bag

Absolute Maximum Ratings

Parameter	Conditions	Rating
Voltage		+5.25 V
Control Voltage		VDD – 0.2 V _{DC}
Storage Temperature		-40 to 150 °C
RF Input Power at TX	Transmit Mode	+15 dBm
RF Input Power at TX	Transmit Bypass Mode	+20 dBm
RF Input Power at ANT		+33 dBm
RF Input Power at SAW2		+5 dBm
T/R Port Load VSWR	Transmit Mode	10:1

Exceeding any one or a combination of the Absolute Maximum Rating conditions may cause permanent damage to the device. Extended application of Absolute Maximum Rating conditions to the device may reduce device reliability.

Recommended Operating Conditions

Parameter	Min.	Typ.	Max.	Units
Operating Frequency	890	925	960	MHz
RF Port Impedance		50		Ω
Device Voltage (VCC_TX1 & VCC_TX2, VDD)	+2.5	+3.6	+4.2	V
Device Voltage (VCC_RX)	+2.5	+3.3	+4.2	V
TX Output Power Control Voltage (VAPC)	0	+2.25	+2.5	V
T _{OPERATING} *	-40		+85	°C

Electrical specifications are measured at specified test conditions. Specifications are not guaranteed over all recommended operating conditions. . * T_{OPERATING} is temperature at package ground.

Electrical Specifications

Parameter	Conditions	Min.	Typ.	Max.	Units
TRANSMIT (TX-ANT) MODE	Unless otherwise noted: VCC_TX1 = 3.6V, VCC_TX2 = 3.6V, VDD = 3.6V, VCC_RX = 0.0V, VAPC = 2.25V, EN = 1.8V, TR = 1.8V, BYP = 0.2V, T=+25°C				
Output Power	V _{CC} TX1, V _{CC} TX2 = 3.6V, P _{IN} = +10dBm	30	30.5		dBm
	V _{CC} TX1, V _{CC} TX2 = 2.7V, P _{IN} = +10dBm	28			dBm
Gain	V _{CC} TX1, V _{CC} TX2 = 3.6V, P _{IN} = +10dBm	20			dB
	V _{CC} TX1, V _{CC} TX2 = 2.7V, P _{IN} = +10dBm	18			dB
TX Port Return Loss		12.5			dB
ANT Port Return Loss		7			dB
Quiescent Current	I _{CC} _TX1/2; I _{CC} TX1 + I _{CC} TX2, RF = Off		100	180	mA
	I _{DD}		7		mA
	I _{CC} _RX		11.5		μA
Operating Current	P _{OUT} = 30.5dBm, ICC TX1 + ICC TX2		840	960	mA
I _{DD}	P _{OUT} = 30.5dBm		12	18	mA
ANT-SAW1 Isolation		44			dB

Parameter	Conditions	Min.	Typ.	Max.	Units
2 nd Harmonics	P _{OUT} = 30.5dBm			-60	dBc
3 rd Harmonics	P _{OUT} = 30.5dBm			-60	dBc
TRANSMIT BYPASS (TX-ANT) MODE	Unless otherwise noted VCCTx1 = 3.6V, VCCTx2 = 3.6V, VDD = 3.6V, VCCRx = 0.0V, VAPC = 0.0V, EN = 1.8V, TR = 1.8V, BYP = 1.8V, T=+25°C				
Insertion Loss	P _{IN} = +5dBm		2	2.7	dB
TX Port Return Loss		18			dB
ANT Port Return Loss		13.5			dB
Input P _{1dB}		27	28		dBm
Input IP3			41		dBm
ANT-SAW1 Isolation		24			dB
2 nd Harmonic Attenuation	P _{IN} = +12dBm, Second Harmonic Insertion Loss			-46	dBc
3 rd to 10 th Harmonic Attenuation	P _{IN} = +12dBm, Third - Tenth Harmonic Insertion Loss			-47	dBc
RECEIVE (SAW2-RX) LNA ON MODE	Unless otherwise noted: VCCTx1 = 3.3V, VCCTx2 = 3.3V, VDD = 3.3V, VCCRx = 3.3V, VAPC = 0.0V, EN = 1.8V, TR = 0.2V, BYP = 0.2V, T=+25°C				
Gain		13.5	15.5	16	dB
ANT-SAW1 Insertion Loss			0.5		dB
Noise Figure			2.1		dB
SAW2 Port Return Loss		18			dB
RX Port Return Loss		10			dB
ANT Port Return Loss		9	10		dB
SAW1 Port Return Loss		9	10		dB
Input P _{1dB}			-2.5		dBm
Input IP3		+1.4	+3		dBm
I _{DD}			150		μA
Rx Operating Current		4	5	6	mA
RECEIVE (SAW2-RX) BYPASS MODE	Unless otherwise noted: VCCTx1 = 3.3V, VCCTx2 = 3.3V, VDD = 3.3V, VCCRx = 3.3V, VAPC = 0.0V, EN = 1.8V, TR = 0.2V, BYP = 1.8V, T=+25°C				
Bypass Loss		1.6	2.2	2.4	dB
ANT-SAW1 Insertion Loss			0.5		dB
SAW2 Port Return Loss		11			dB
RX Port Return Loss		14			dB
ANT Port Return Loss		9	10		dB
SAW1 Port Return Loss		9	10		dB
Input P _{1dB}			+17.5		dBm
Input IP3			+42		dBm
Current	I _{CC_TX1/2}		90		μA
	I _{DD}		100		μA
	I _{CC_RX}		50		nA
GENERAL SPECIFICATIONS	Unless otherwise noted: VCC_TX1 = 3.6V, VCC_TX2 = 3.6V, VDD = 3.6V, VCC_RX = 3.6V, VAPC = 0.0V, EN = Low, TR = X, BYP = X, PA = OFF, LNA = OFF, T=+25°C				
Leakage Current	VDD		0.05	1.0	μA
	VCC_TX1, VCC_TX2		0.05	1.0	μA
	VCC_RX		0.05	1.0	μA

Parameter	Conditions	Min.	Typ.	Max.	Units
Control Voltage - High		1.6		4	V
Control Current - High			0.1		μA
Control Voltage - Low			0.2	0.3	V
Control Current - Low			0.1		μA
VAPC High Current	Across all rated voltages at rated power		50		μA
Thermal Resistance, θ_{jc}	3.6V V _{CC} , 100% Duty, 30.2 dBm P _{OUT} , T _{REF} = 85° C		24.73		°C/W

Notes:

- 868MHz data available upon request.

Logic Truth Table

Mode	TR	EN	BYP	PA	LNA
Transmit	High	High	Low	On	Off
Transmit Bypass	High	High	High	Off	Off
Receive	Low	High	Low	Off	On
Receive Bypass	Low	High	High	Off	Off
Shutdown	X	Low	X	Off	Off

Typical Performance

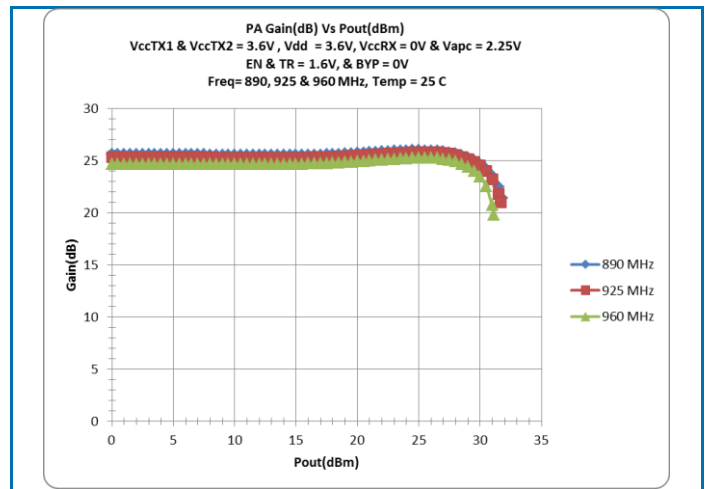
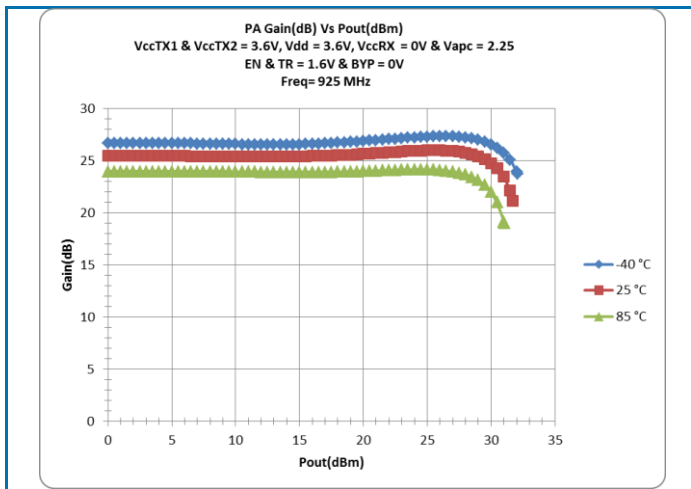

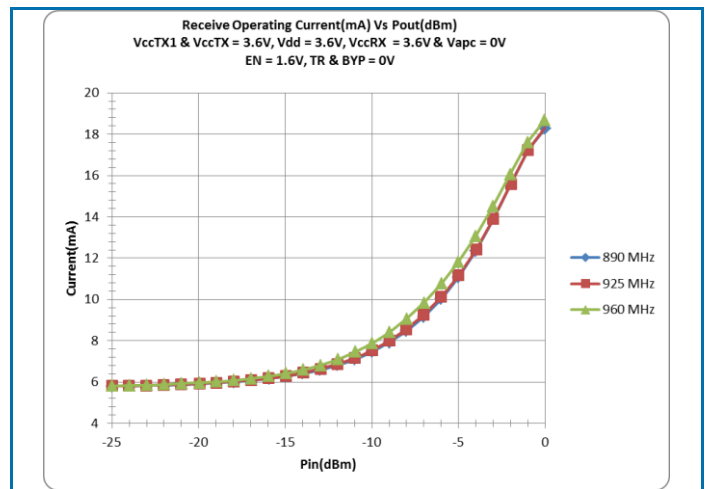
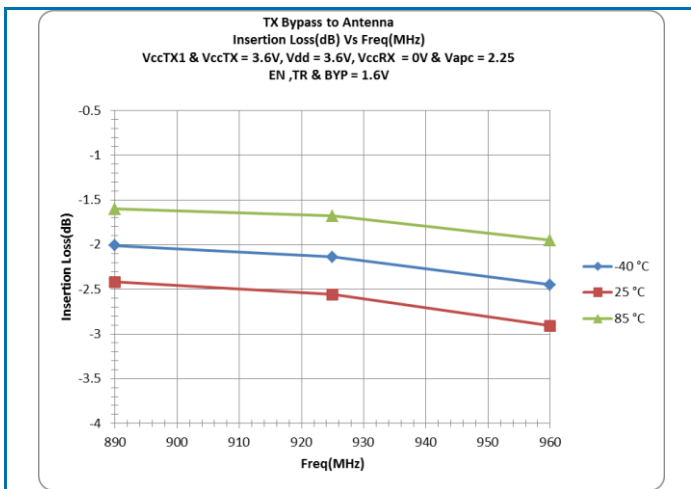
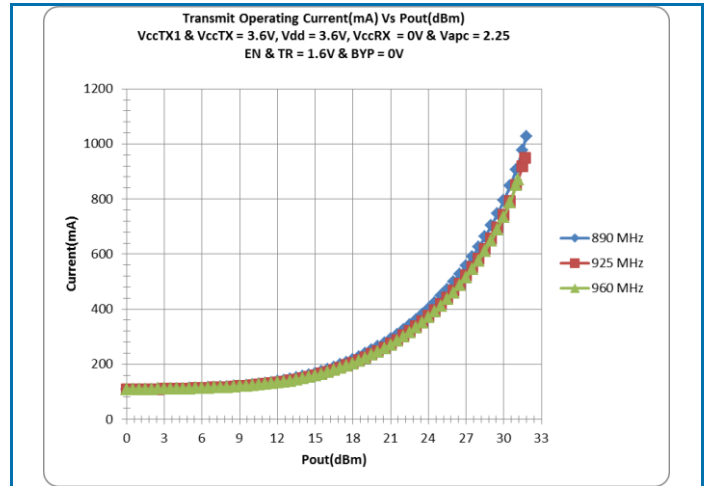
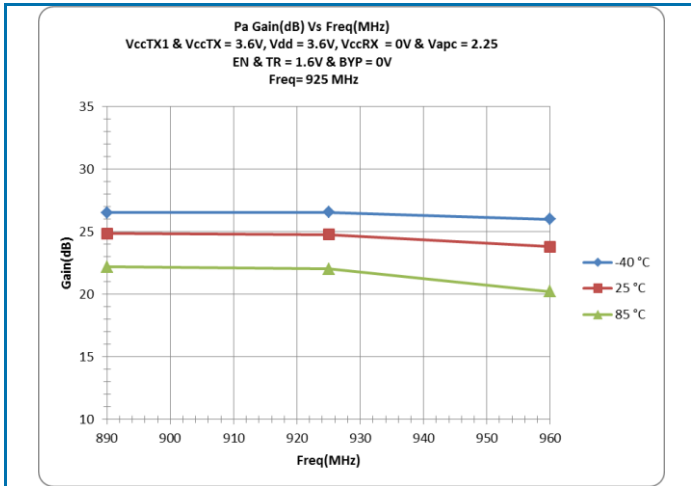
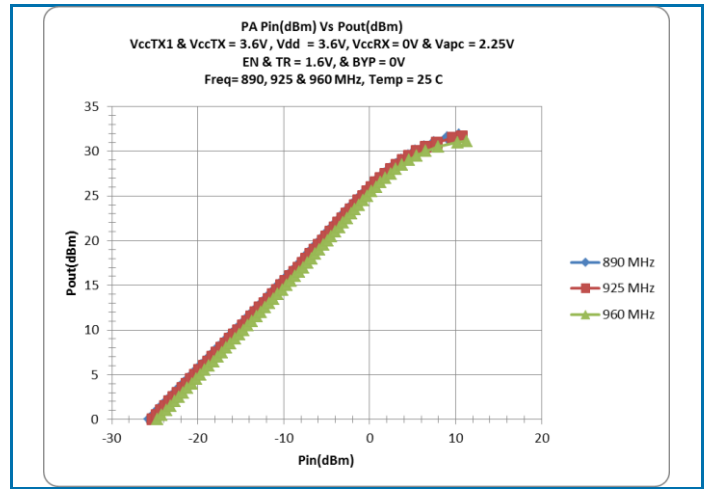
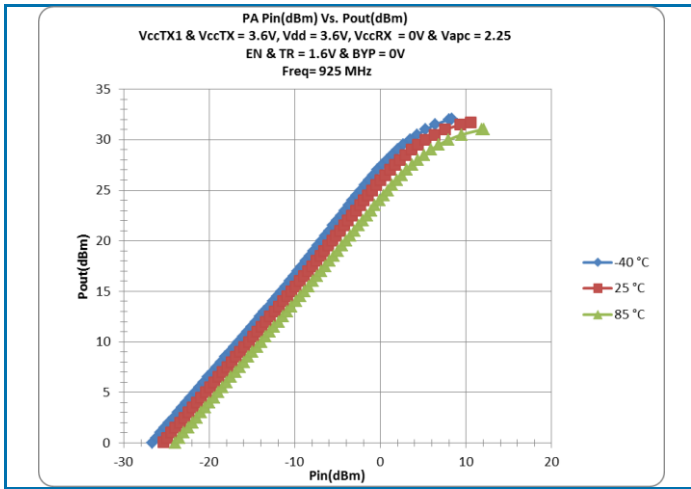

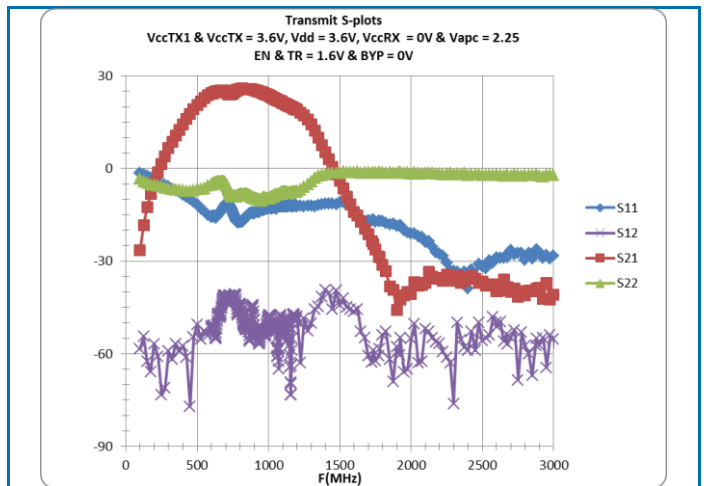
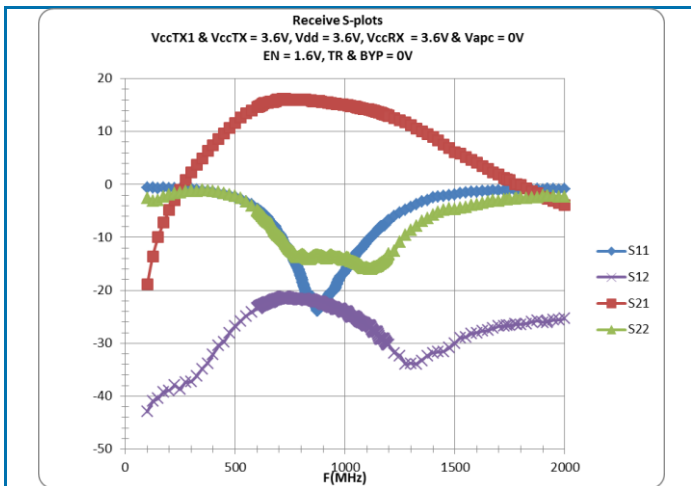
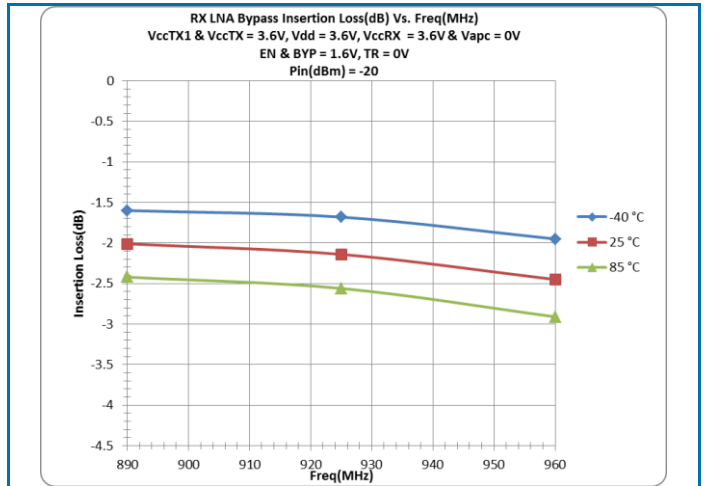
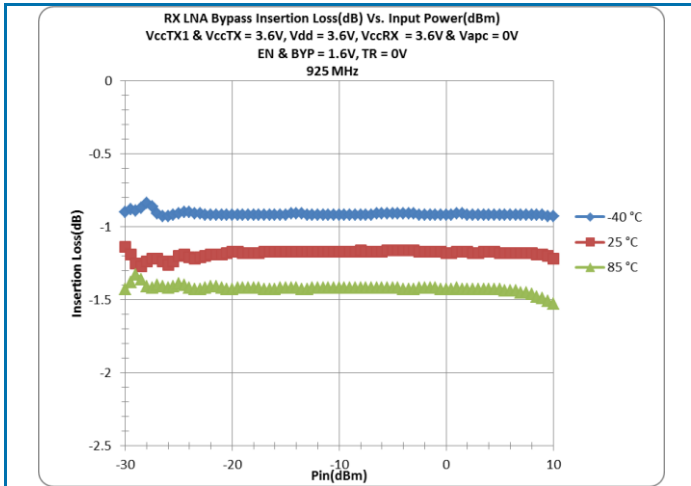
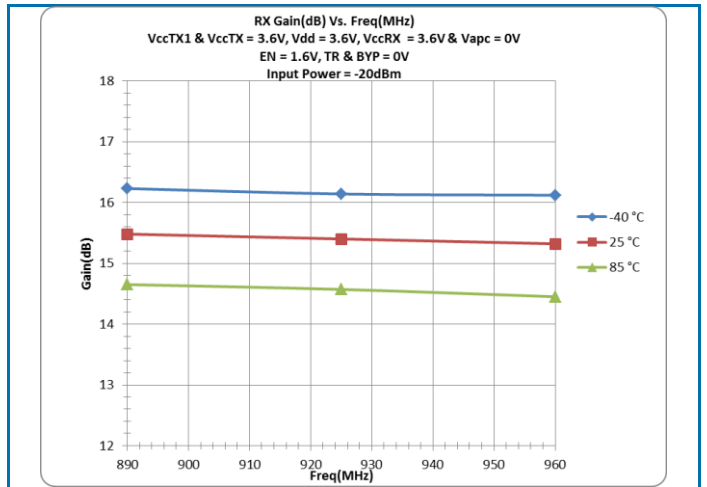
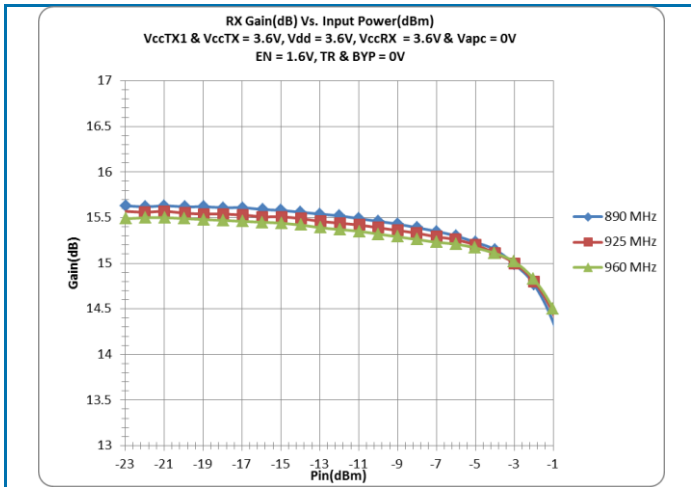

Evaluation Board Schematic and Layout

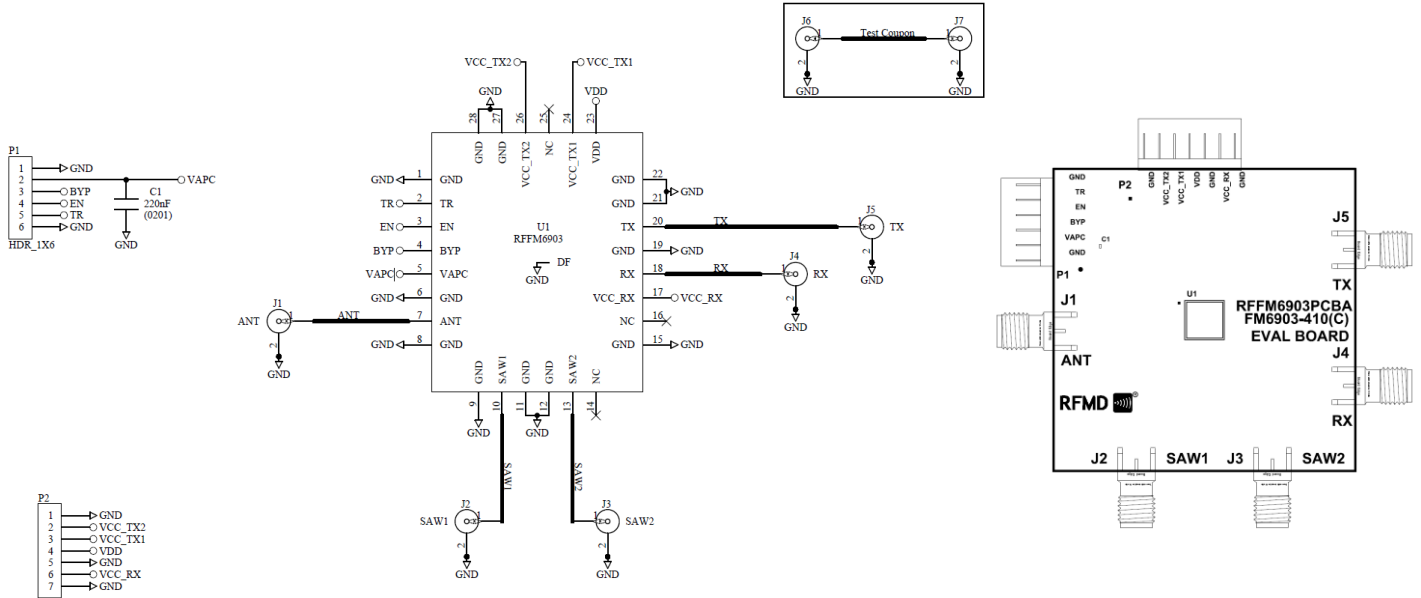

Bill of Material

Ref. Des.	Value	Description	Manuf.	Part number
-	-	Printed Circuit Board		
U1	-	900MHz ISM Front End Module	Qorvo	RFFM6903
C1	0.22 μ F	Capacitor, Chip, 20%, 6.3V, X5R, 0201	Murata	GRM033R60J224ME15D
C2, C3, C4	-	Do Not Install		

Pin Configuration and Description

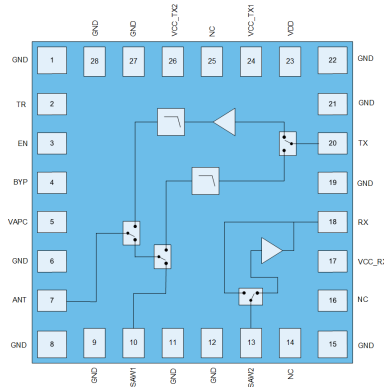

Top View

Pin Number	Label	Description
1	GND	Ground connection.
2	TR	Control pin.
3	EN	Control pin.
4	BYP	Control pin.
5	VAPC	Control pin.
6	GND	Ground connection.
7	ANT	RF bi-directional antenna port. Internally matched to 50 Ω and DC blocked.
8	GND	Ground connection.
9	GND	Ground connection.
10	SAW1	Receive side of antenna switch. Internally matched to 50 Ω and DC blocked.
11	GND	Ground connection.
12	GND	Ground connection.
13	SAW2	RX and RX bypass input port. Internally matched to 50 Ω and DC blocked.
14	NC	No connection
15	GND	Ground connection.
16	NC	No connection
17	VCC_RX	Supply voltage
18	RX	RF output. Internally matched to 50 Ω and DC shorted. ⁽¹⁾
19	GND	Ground connection.
20	TX	RF input. Internally matched to 50 Ω and DC shorted. ⁽¹⁾
21	GND	Ground connection.
22	GND	Ground connection.
23	VDD	Supply voltage
24	VCC_TX1	Supply voltage
25	NC	No connection
26	VCC_TX2	Supply voltage
27	GND	Ground connection.
28	GND	Ground connection.
Backside Paddle	-	RF/DC ground. Use recommended via pattern to minimize inductance and thermal resistance. See PCB Mounting Pattern for suggested footprint.

Mechanical Information

Dimensions and PCB Mounting Pattern

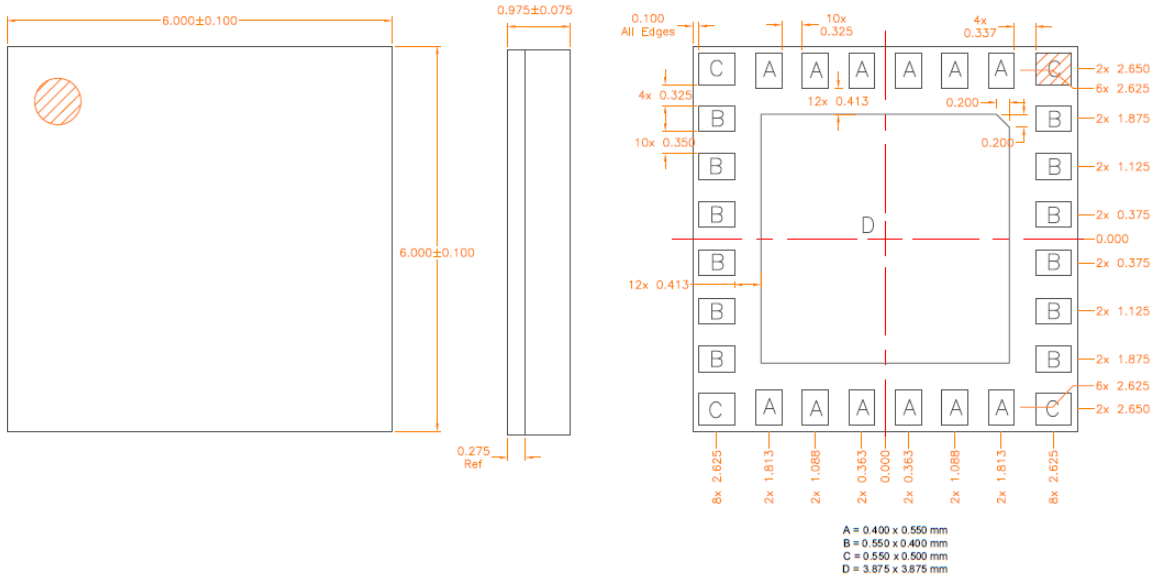

Notes:
1. Shaded area represents Pin 1 location.

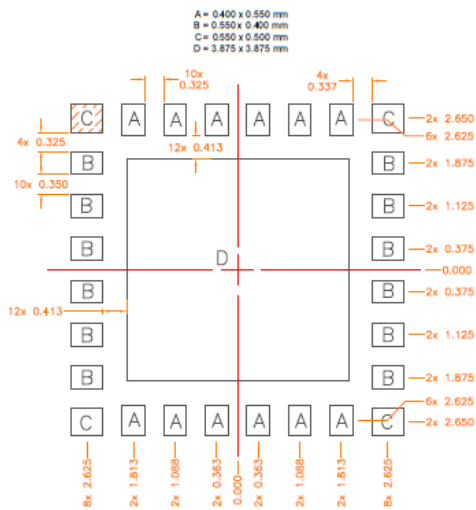

PCB Metal Land Pattern

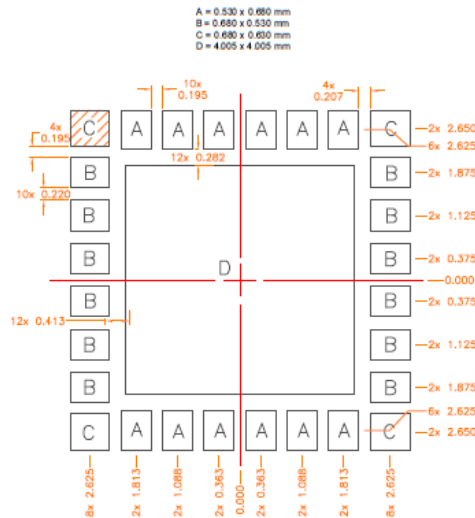

PCB Solder Mask Pattern

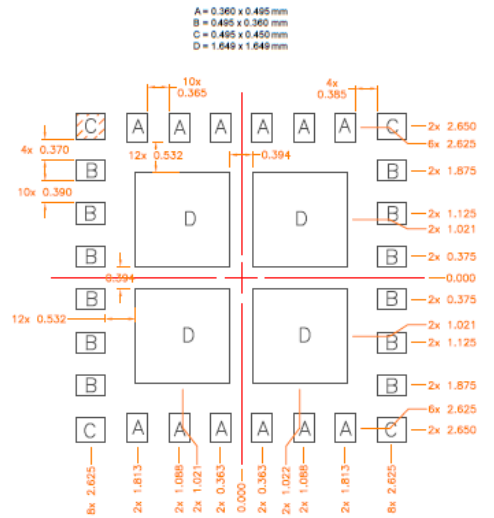

PCB Stencil Pattern

Notes:
2. All dimensions are in millimeters. Angles are in degrees.
3. Dimension and tolerance formats conform to ASME Y14.4M-1994.
4. The terminal #1 identifier and terminal numbering conform to JESD 95-1SP-012

Handling Precautions

Parameter	Rating	Standard
ESD – Human Body Model (HBM)	Class 1A (350V)	JESD22-A114
ESD – Charged Device Model (CDM)	Class II (300 V)	JESD-22A101
MSL – Moisture Sensitivity Level	Level 3	IPC/JEDEC J-STD-020



Caution!

ESD sensitive device

Solderability

Compatible with both lead-free (260 °C max. reflow temperature) and tin/lead (245 °C max. reflow temperature) soldering processes.

Package lead plating: Electroless Ni/Electroless Pd/Immersion Au (ENEPIG)

RoHS Compliance

This part is compliant with the 2011/65/EU RoHS directive (Restrictions on the Use of Certain Hazardous Substances in Electrical and Electronic Equipment), as amended by Directive 2015/863/EU.

This product also has the following attributes:

- Lead free
- Halogen Free (Chlorine, Bromine)
- Antimony Free
- TBBP-A (C₁₅H₁₂Br₄O₂) Free
- SVHC Free



Contact Information

For the latest specifications, additional product information, worldwide sales and distribution locations:

Web: www.qorvo.com

Tel: 1-844-890-8163

Email: customer.support@qorvo.com

Important Notice

The information contained herein is believed to be reliable; however, Qorvo makes no warranties regarding the information contained herein and assumes no responsibility or liability whatsoever for the use of the information contained herein. All information contained herein is subject to change without notice. Customers should obtain and verify the latest relevant information before placing orders for Qorvo products. The information contained herein or any use of such information does not grant, explicitly or implicitly, to any party any patent rights, licenses, or any other intellectual property rights, whether with regard to such information itself or anything described by such information. **THIS INFORMATION DOES NOT CONSTITUTE A WARRANTY WITH RESPECT TO THE PRODUCTS DESCRIBED HEREIN, AND QORVO HEREBY DISCLAIMS ANY AND ALL WARRANTIES WITH RESPECT TO SUCH PRODUCTS WHETHER EXPRESS OR IMPLIED BY LAW, COURSE OF DEALING, COURSE OF PERFORMANCE, USAGE OF TRADE OR OTHERWISE, INCLUDING THE IMPLIED WARRANTIES OF MERCHANTABILITY AND FITNESS FOR A PARTICULAR PURPOSE.**

Without limiting the generality of the foregoing, Qorvo products are not warranted or authorized for use as critical components in medical, life-saving, or life-sustaining applications, or other applications where a failure would reasonably be expected to cause severe personal injury or death.

Copyright 2020 © Qorvo, Inc. | Qorvo is a registered trademark of Qorvo, Inc.

X-ON Electronics

Largest Supplier of Electrical and Electronic Components

Click to view similar products for [RF Front End](#) category:

Click to view products by [Qorvo](#) manufacturer:

Other Similar products are found below :

[SE2622L-R](#) [BGM1032N7E6327XUSA1](#) [LX5586LL](#) [LX5586HLL](#) [LX5586ALL](#) [SKY66111-21](#) [SKY65728-11](#) [SKY68000-31](#) [SKY85308-11](#)
[SKY85302-11](#) [SKY85300-21](#) [SKY65724-11](#) [ADTR1107ACCZ](#) [LMP91051MTX/NOPB](#) [SE5501L-R](#) [QPF4519SR](#) [SE5503A-R](#)
[ADA8282WBCPZ](#) [ADRF5545ABCPZN](#) [ADRF5545ABCPZN-R7](#) [AD8283WBCPZ](#) [AD8284WCSVZ](#) [ADRF5547BCPZN](#)
[ADRF5547BCPZN-R7](#) [ADRF5549BCPZN](#) [ADRF5549BCPZN-R7](#) [HV7350K6-G](#) [SE5516A-R](#) [MCP2030-I/SL](#) [MAX2009ETI+](#)
[MAX2078CTK+](#) [MAX2335ETI+](#) [MAX2678GTB/V+T](#) [MD2131K7-G](#) [MD2134K7-G](#) [RFFM4554SR](#) [RFFM4554TR7](#) [RFFM8504SR](#)
[RFFM8511SR](#) [RFFM4552TR7](#) [RFFM4503TR7](#) [RFFM6903TR13](#) [HV7351K6-G](#) [MCP2035-I/ST](#) [SE2614BT-R](#) [SE2438T-R](#) [SST12LF02-](#)
[QXCE](#) [SST12LF09-Q3CE](#) [RFX2401C](#) [RFX2402E](#)