

RFPA2016

3-Stage Power Amplifier, 1W
700MHz to 2700MHz

The RFPA2016 is a 3-stage HBT power amplifier module with high gain and excellent efficiency. External matching and bias control allows the RFPA2016 to be optimized for various applications including small-cell power amplifiers and ultra-linear driver amplifiers within 700MHz and 2700MHz. Users can also bypass the first stage to reduce gain and power consumption.



Package: MCM, 28-pin,
6.0mm x 6.0mm

Features

- WCDMA Power at 2140MHz = 21dBm with -45dBc ACPR
- Flexible External Matching for Band Selection
- Gain = 36dB at 2140MHz
- P1dB = 31dBm at 2140MHz
- 5V Supply
- Independent Bias Control for Each Stage
- Power-down Capability
- Integrated Power Detector

Applications

- 2G, 3G, and 4G Air Interfaces
- Picocell, Femtocell Power Amplifier Module
- Driver Amplifier for Commercial Wireless Infrastructure

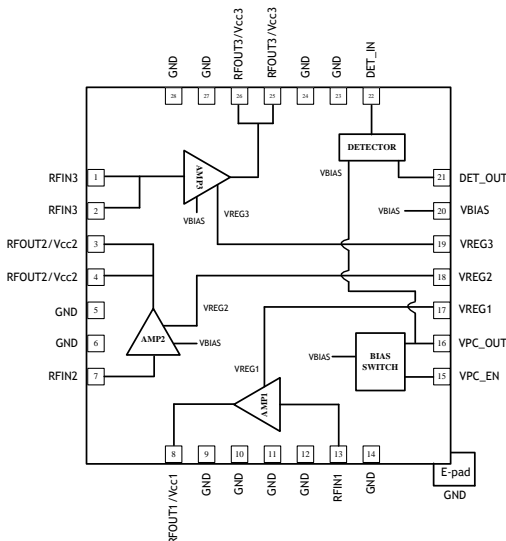

Functional Block Diagram

Ordering Information

RFPA2016SQ	Sample bag with 25 pieces
RFPA2016SR	7" Reel with 100 pieces
RFPA2016TR13	13" Reel with 2500 pieces
RFPA2016PCK-410	728MHz to 768MHz PCBA with 5-piece sample bag
RFPA2016PCK-411	2110MHz to 2170MHz PCBA with 5-piece sample bag
RFPA2016PCK-412	2620MHz to 2690MHz PCBA with 5-piece sample bag

Absolute Maximum Ratings¹

Parameter	Rating	Unit
Supply Voltage (V_{CC} , V_{BIAS} , V_{EN})	6.0	V
Amp1 DC Current (I_{CC1})	100	mA
Amp2 DC Current (I_{CC2})	250	mA
Amp3 DC Current (I_{CC3})	800	mA
CW Input Power, 50Ω, 2-Stage Operation	1	dBm
CW Input Power, 50Ω, 3-Stage Operation	18	dBm
Modulated (WCDMA) Input Power, 6:1 output VSWR, 2-Stage Operation	-6	dBm
Modulated (WCDMA) Input Power, 6:1 output VSWR, 3-Stage Operation	7	dBm
Storage Temperature Range	-40 to +150	°C
ESD Rating - Human Body Model (HBM)	Class 1A	
Moisture Sensitivity Level	MSL3	



Caution! ESD sensitive device.



RFMD Green: RoHS status based on EU Directive 2011/65/EU (at time of this document revision), halogen free per IEC 61249-2-21, < 1000ppm each of antimony trioxide in polymeric materials and red phosphorus as a flame retardant, and <2% antimony in solder.

Exceeding any one or a combination of the Absolute Maximum Rating conditions may cause permanent damage to the device. Extended application of Absolute Maximum Rating conditions to the device may reduce device reliability. Specified typical performance or functional operation of the device under Absolute Maximum Rating conditions is not implied.

Notes:

1. The maximum ratings must all be met simultaneously

Recommended Operating Condition

Parameter	Specification			Unit
	Min	Typ	Max	
Operating Temperature Range	-40		+85	°C
Operating Junction Temperature (T_J) ^{1&2}			165	°C
Collector Voltage (V_{CC1} , V_{CC2} , V_{CC3}) ³	2.7	5	5.25	V

Notes:

1. T_J for 1e6 hours MTTF, CW Operation
2. $T_J = T_L + P_{DISS} * R_{TH}$
3. Max recommended operational collector voltage

Nominal Operating Parameters

Parameter	Specification			Unit	Condition
	Min	Typ	Max		
728MHz to 768MHz					$V_{CC} = 5.0V$, Temp = 25°C, Optimized for -45dBc ACPR at rated power
Frequency		748		MHz	
Input Power			-2	dBm	Max recommended continuous input power, $V_{CC} = 5.0V$, Load VSWR = 2:1
Gain		35		dB	Stage 1 bypassed
ACPR		-48		dBc	RF output power = 21dBm, WCDMA 3GPP 3.5, test model 1, 64 DPCH
P1dB		31.5		dBm	
Output IP3		40		dBm	18dBm per tone, 1MHz spacing, optimized for best ACPR
Detector Output Voltage		0.85		V	CW RF output power = 21dBm with 0.3pF coupling capacitor
Input Return Loss		20		dB	

Parameter	Specification			Unit	Condition
	Min	Typ	Max		
Output Return Loss		12		dB	
Noise Figure		3.4		dB	
2.11GHz to 2.17GHz					V_{CC} = 5.0V, Temp = 25°C, Optimized for -45dBc ACPR at rated power
Frequency		2.14		GHz	
Input Power			0	dBm	Max recommended continuous input power, V _{CC} = 5.0V, Load VSWR = 2:1
Gain	32	36	40	dB	
ACPR		-48	-43	dBc	RF output power = 21dBm, WCDMA 3GPP 3.5, test model 1, 64 DPCH
P1dB		31.4		dBm	
Output IP3		41		dBm	18dBm per tone, 1MHz spacing, optimized for best ACPR
Detector Output Voltage		0.8		V	CW RF output power = 21dBm with 0.2pF coupling capacitor
Input Return Loss		20		dB	
Output Return Loss		14		dB	
Noise Figure		5.3		dB	
2.62GHz to 2.69GHz					V_{CC} = 5.0V, Temp = 25°C, Optimized for -45dBc ACPR at rated power
Frequency		2.65		GHz	
Input Power			0	dBm	Max recommended continuous input power, V _{CC} = 5.0V, Load VSWR = 2:1
Gain		34		dB	
ACPR		-47		dBc	RF output power = 21dBm, WCDMA 3GPP 3.5, test model 1, 64 DPCH
P1dB		31		dBm	
Output IP3		40.5		dBm	18dBm per tone, 1MHz spacing, optimized for best ACPR
Detector Output Voltage		0.9		V	CW RF output power = 21dBm with 0.2pF coupling capacitor
Input Return Loss		20		dB	
Output Return Loss		11		dB	
Noise Figure		5.3		dB	
Power Supply					V_{CC} = 5.0V, 2140MHz bias conditions
Amp1 Quiescent Current	30	40	50	mA	At V _{CC1} = V _{BIAS} = 5V, VPC_EN = 1.8V, off for 750MHz band
Amp2 Quiescent Current	55	75	90	mA	At V _{CC2} = V _{BIAS} = 5V, VPC_EN = 1.8V
Amp3 Quiescent Current	155	190	240	mA	At V _{CC3} = V _{BIAS} = 5V, VPC_EN = 1.8V
V _{BIAS}	4.75	5	5.25	V	V _{BIAS} = V _{CC} under normal operating conditions
Enable Voltage High (VPC_EN)	1.6	2.5	5.25	V	Normal operation
Enable Voltage Low (VPC_EN)		0	0.8	V	Module shutdown

Parameter	Specification			Unit	Condition
	Min	Typ	Max		
Power Supply - Continued					V_{CC} = 5.0V, 2140MHz bias conditions
Enable Current		115		μA	V _{EN} = 2.5V
Shutdown Leakage Current		185	300	μA	V _{CC} = V _{BIAS} = 5V, VPC_EN = 0.5V
Thermal Resistance (R _{TH})		26		°C/W	Junction-to-back side of IC

Typical Performance: $V_{CC} = V_{BIAS} = 5V$, $V_{EN} = 1.8V$
 728MHz to 768MHz Application Circuit

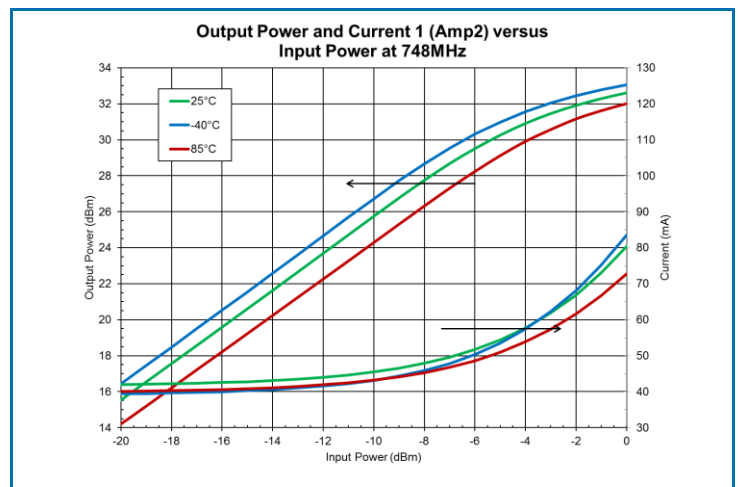
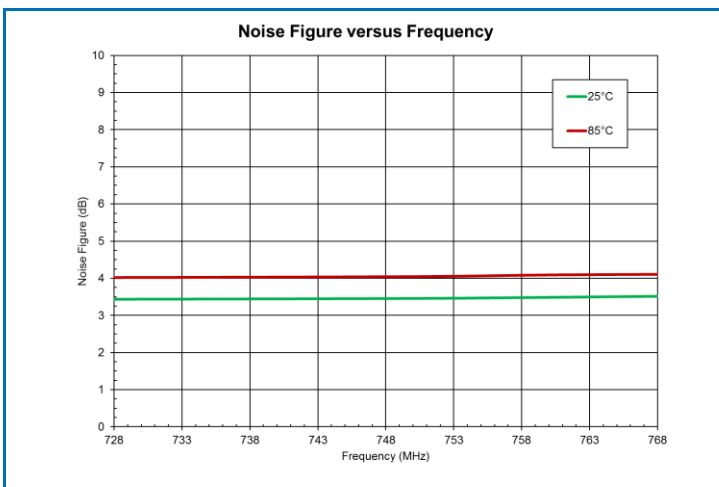
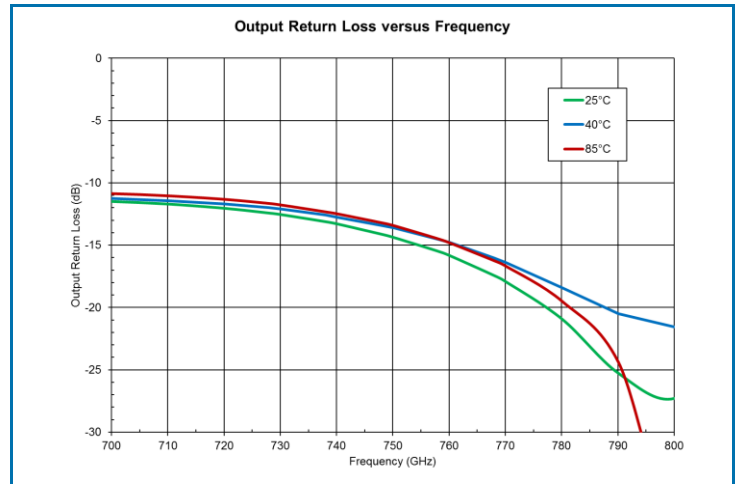
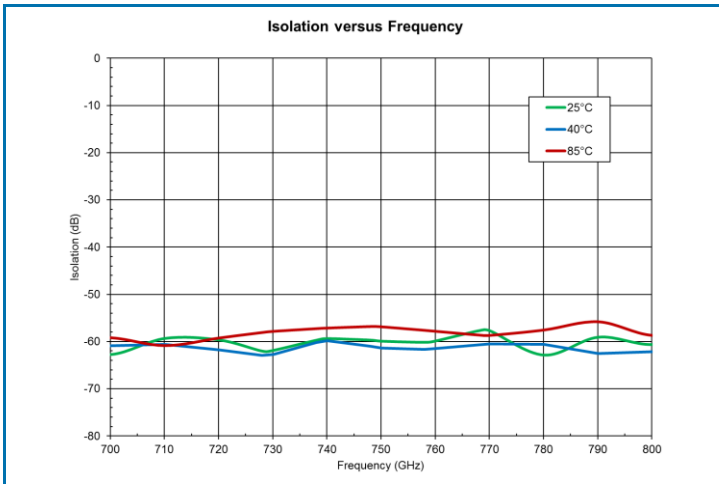
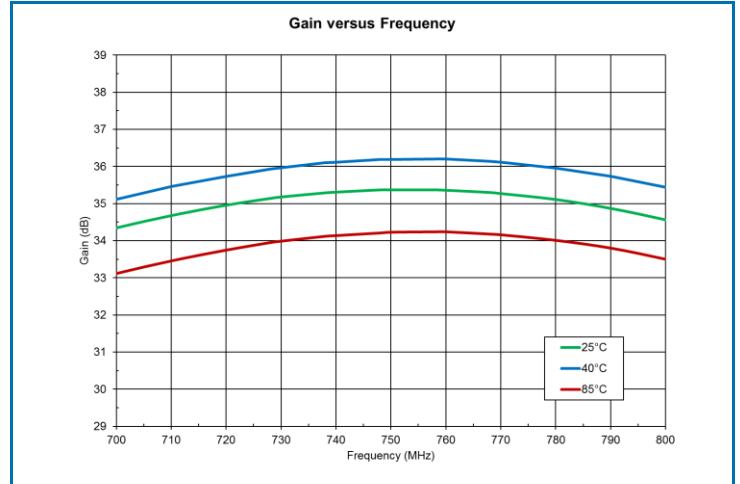
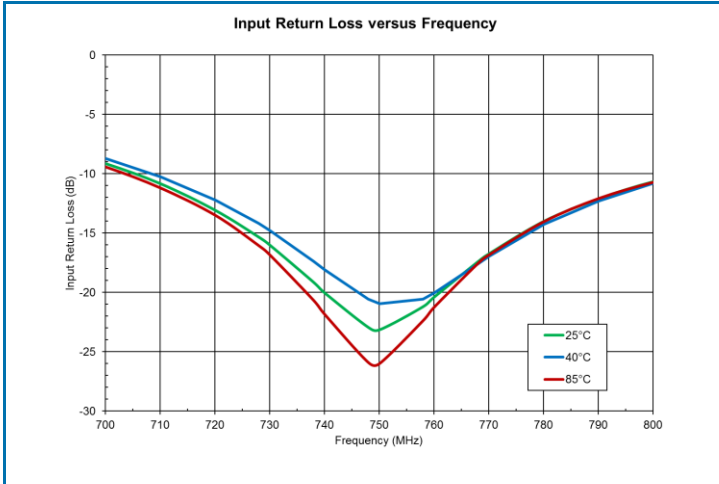

Typical Performance: $V_{CC} = V_{BIAS} = 5V$, $V_{EN} = 1.8V$
 728MHz to 768MHz Application Circuit

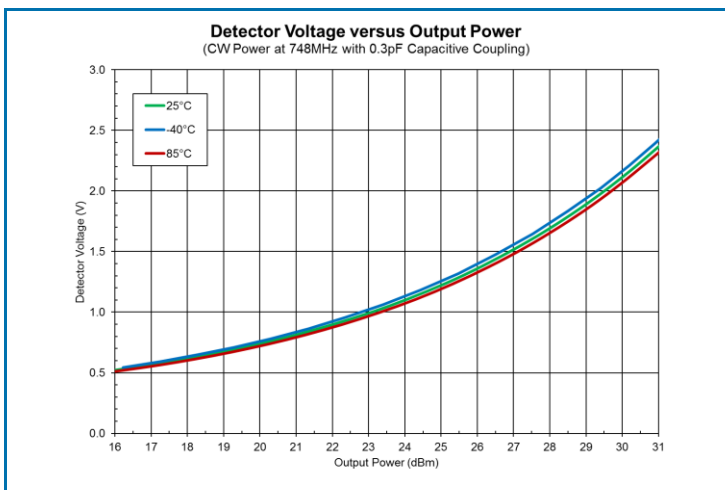
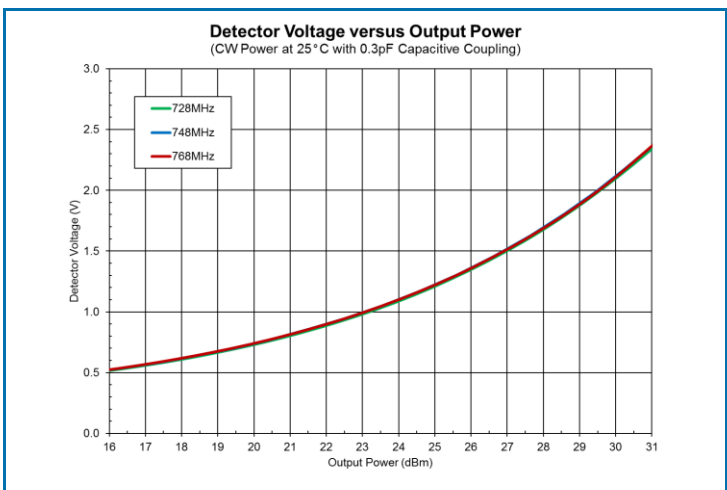
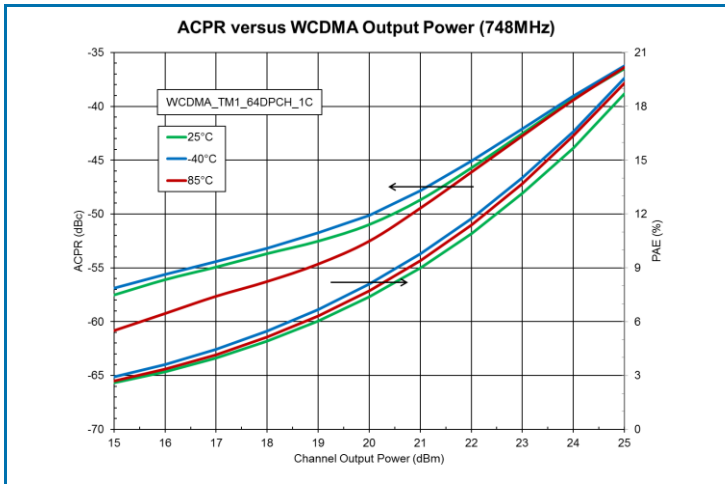
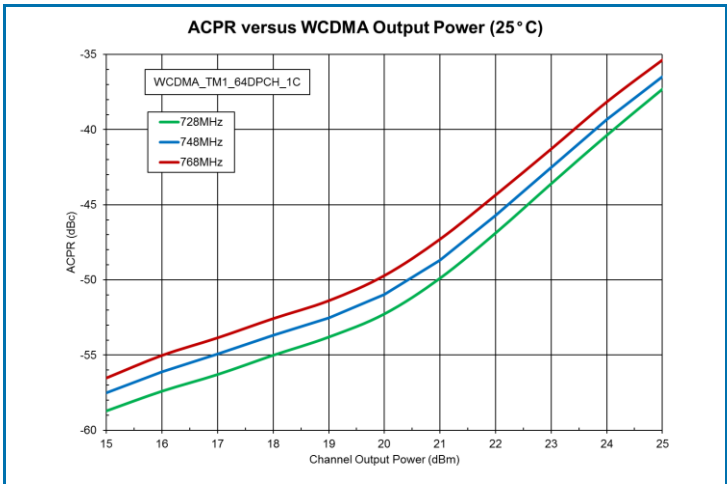
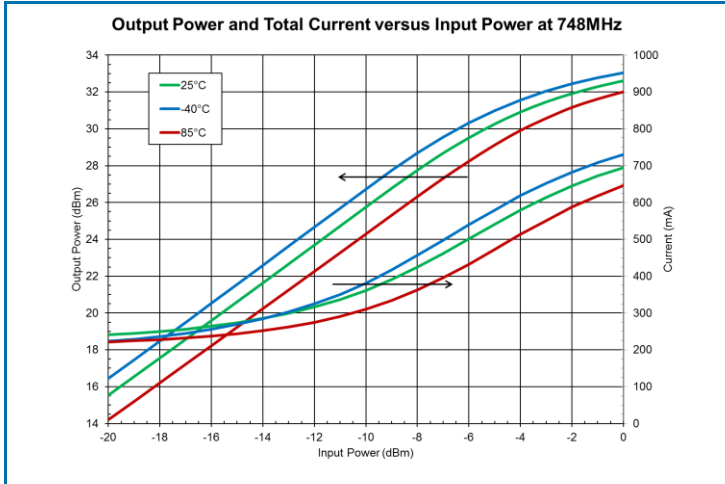
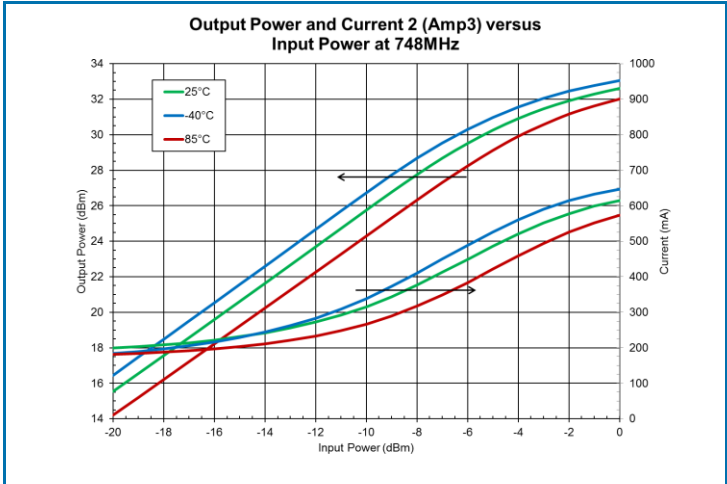

Typical Performance: $V_{CC} = V_{BIAS} = 5V$, $V_{EN} = 1.8V$
 728MHz to 768MHz Application Circuit

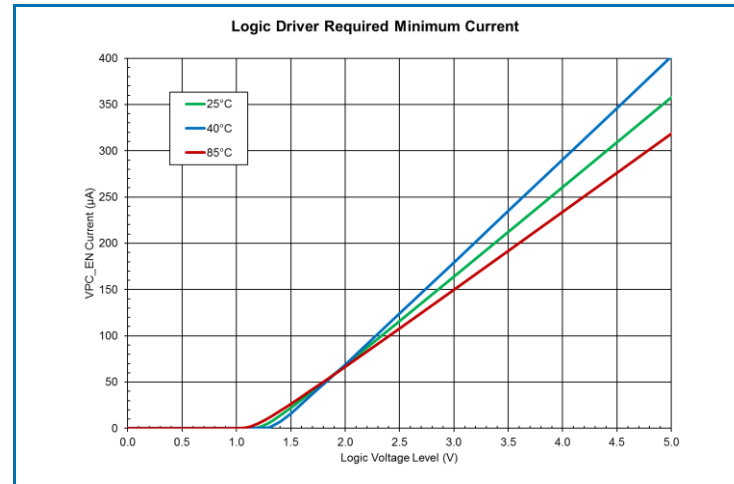
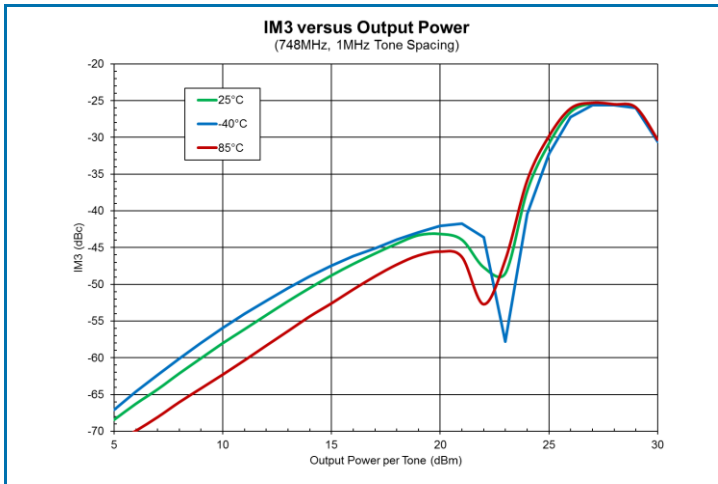
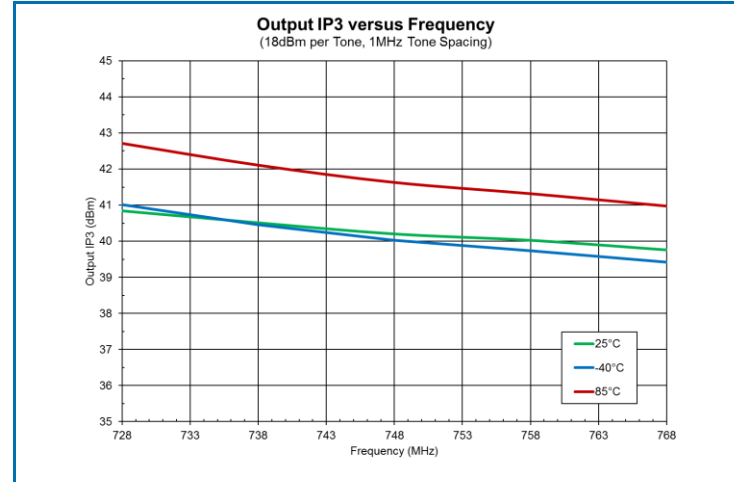
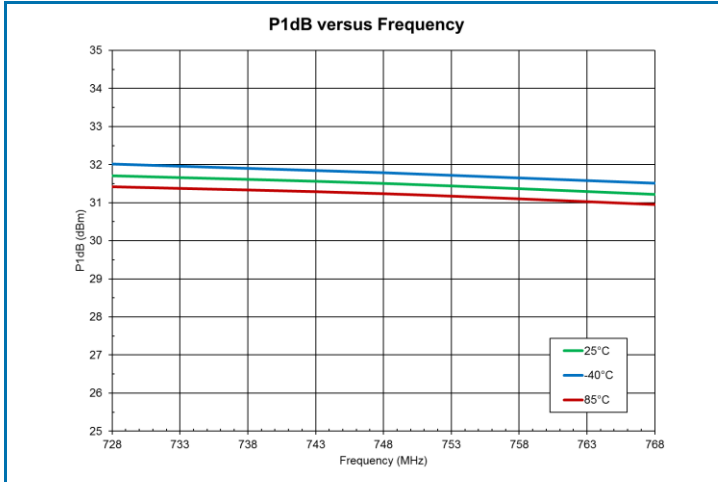

Evaluation Board Schematic 728MHz to 768MHz Application Circuit

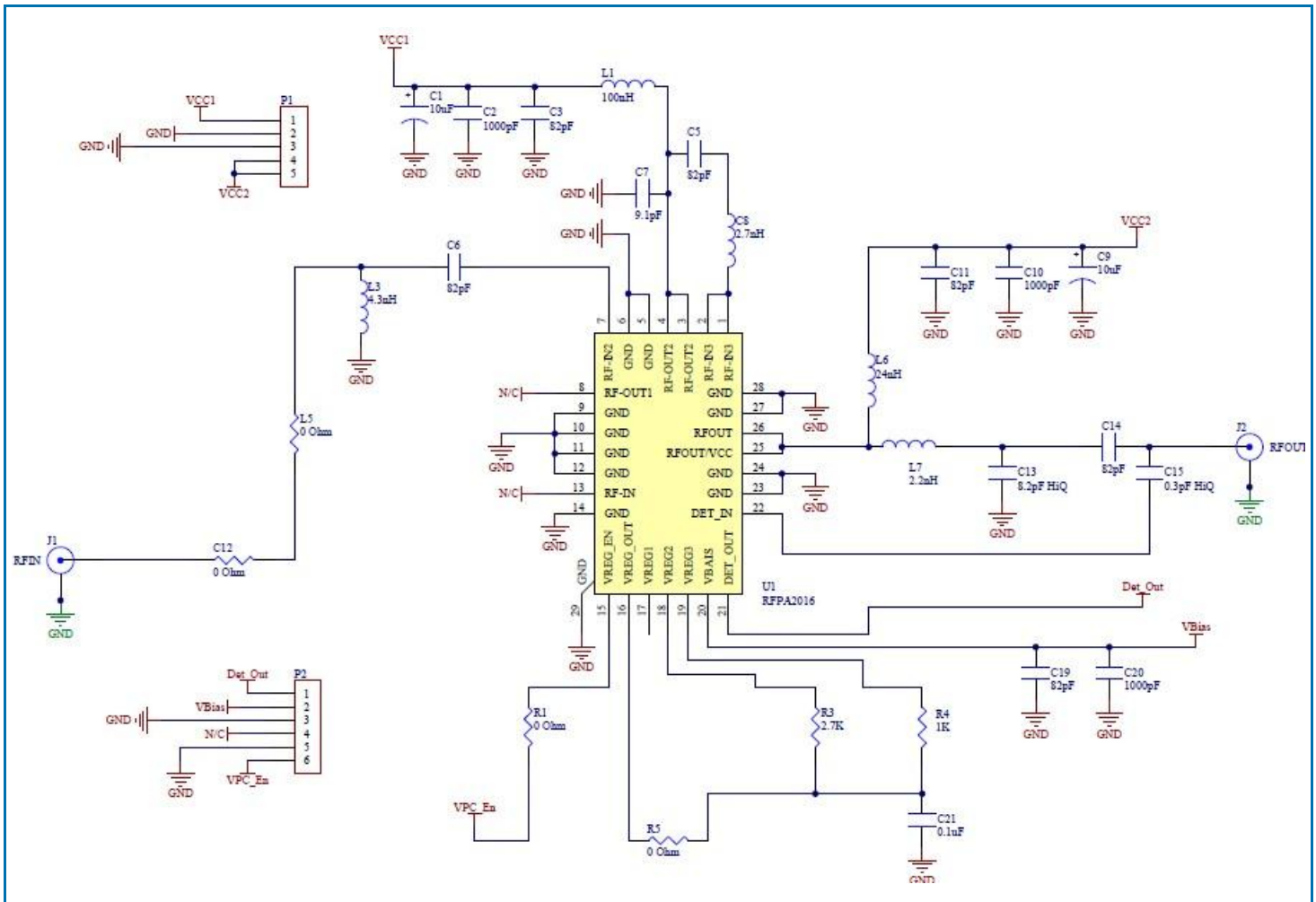

Evaluation Board Bill of Materials (BOM) 728MHz to 768MHz Application Circuit

Description	Reference Designator	Manufacturer	Manufacturer's P/N
RFPA2026 Evaluation Board		Dynamic Details (DDI) Toronto	RFPA2026-411(A)
700MHz to 2700MHz PA, 1W, 32dB Gain, Ext. Match	U1	RFMD	RFPA2016
CAP, 10 μ F, 10%, 10V, TANT-A	C1, C9	AVX Corporation	TAJA106K010RNJ
CAP, 1000pF, 10%, 50V, X7R, 0402	C2, C10, C20	Taiyo Yuden (USA), Inc.	RM UMK105BJ102KV-F
CAP, 82pF, 5%, 50V, C0G, 0402	C3, C5-C6, C14, C19, C22	Murata Electronics	GRM1555C1H820JZ01D
CAP, 9.1pF, +/-0.5pF, 50V, C0G, 0402	C7	Murata Electronics	GRM1555C1H9R1DA01D
IND, 2.7nH, +/-0.3nH, M/L, 0402	C8	Toko Inc.	LL1005-FH2N7S
CAP, 8.2pF, +/-0.1pF, 50V, HI-Q, 0402	C13	Johanson Technology	500R07S8R2BV4TD
CAP, 0.3pF, +/-0.05pF, 50V, HI-Q, 0402	C15	Murata Electronics	GJM1555C1HR30WB01D
CAP, 0.1 μ F, 10%, 16V, X7R, 0402	C21	Murata Electronics	GRM155R71C104KA88D
CONN, SMA, 4-HOLE PANEL MOUNT JACK	J1-J2	Gigalane Co., Ltd.	PAF-S00-000
IND, 100nH, 5%, M/L, 0603	L1	Toko Inc.	LL1608-FSLR10J
IND, 4.3nH, +/-0.1nH, T/F, 0402	L3	Murata Electronics	LQP15MN4N3B02D
IND, 24nH, 5%, W/W, 0603	L6	Coilcraft, Inc.	0603HC-24NXJLW
IND, 2.2nH, +/-0.3nH, M/L, 0402	L7	Toko, Inc.	LL1005-FHL2N2S
RES, 0 Ω , 0402	C12, L5, R1, R5	Kamaya, Inc.	RMC1/16SJPTH
CONN, HDR, St, PLRZD, 5-PIN, 0.100"	P1	ITW Pancon	MPSS100-5-C
CONN, HDR, ST, PLRZD, 6-PIN, 0.100"	P2	ITW Pancon	MPSS100-6-C
RES, 2.7K, 5%, 1/16W, 0402	R3	Kamaya, Inc.	RMC1/16S-272JTH
RES, 1K, 5%, 1/16W, 0402	R4	Kamaya, Inc.	RMC1/16S-102JTH
HEATSINK, BLOCK, TEST FIX, 1.5" x 2.0"		Wells Machining	EEF-101217
SCREW, 2-56 x 3/16", SOCKET HEAD	S1-S9	McMaster-Carr Supply Co.	92196A076

Evaluation Board Assembly Drawing 728MHz to 768MHz Application Circuit

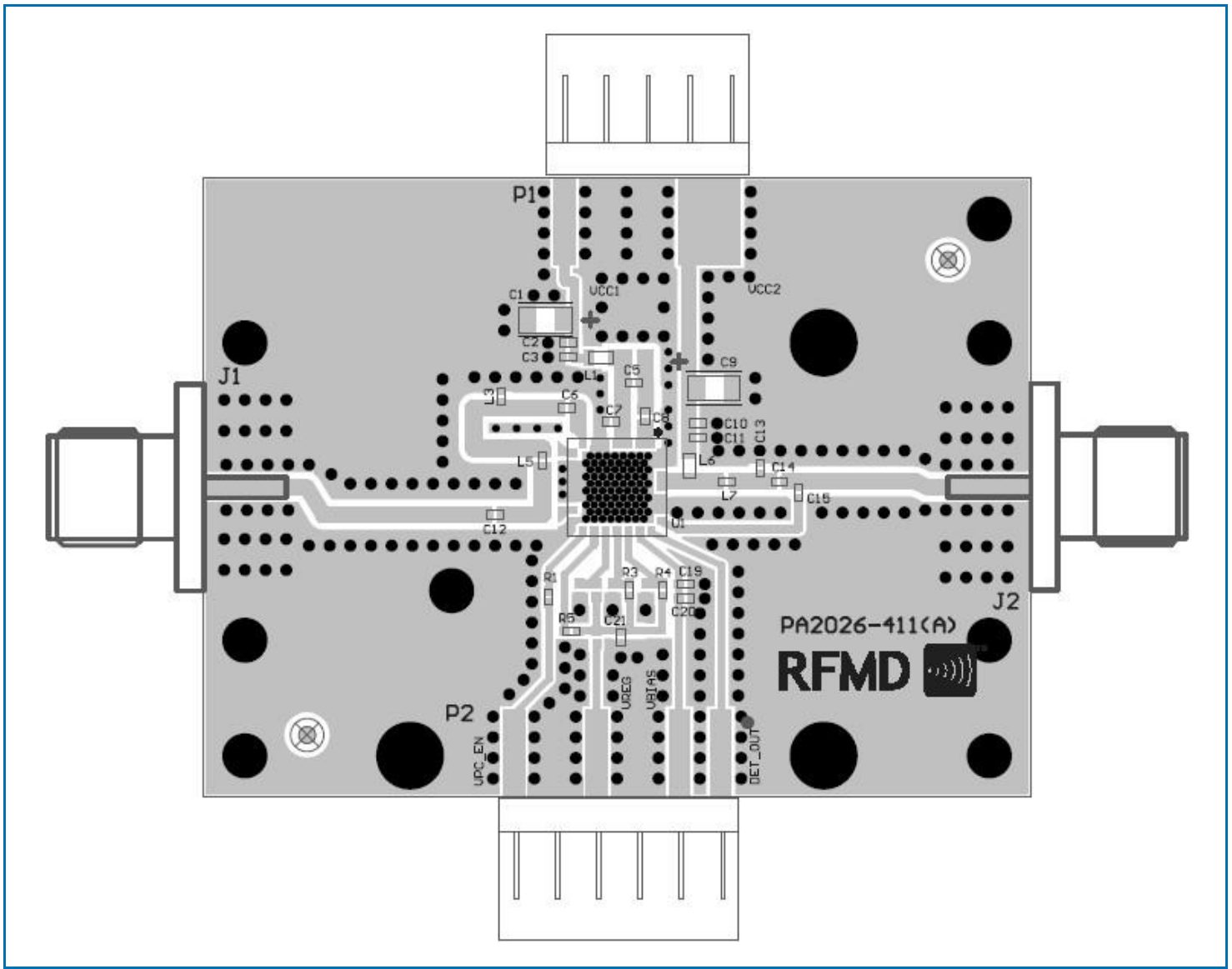

Typical Performance: $V_{CC} = V_{BIAS} = 5V$, $V_{EN} = 1.8V$
 2.11GHz to 2.17GHz Application Circuit

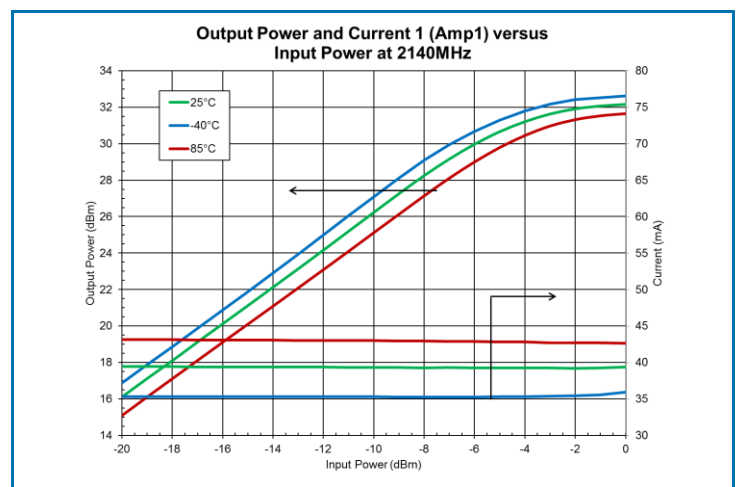
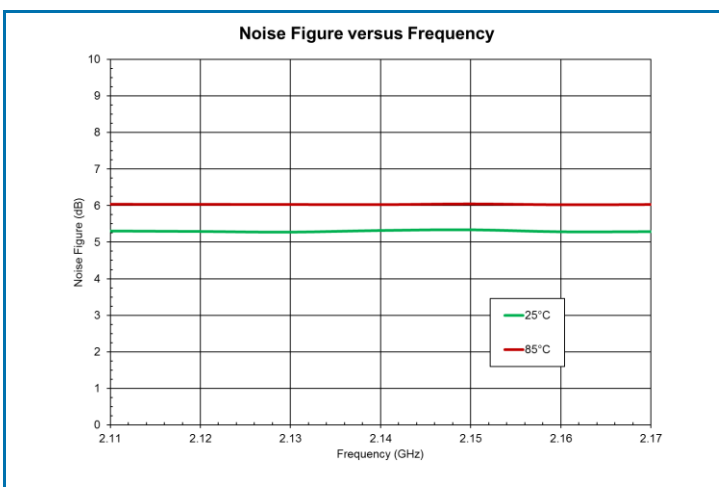
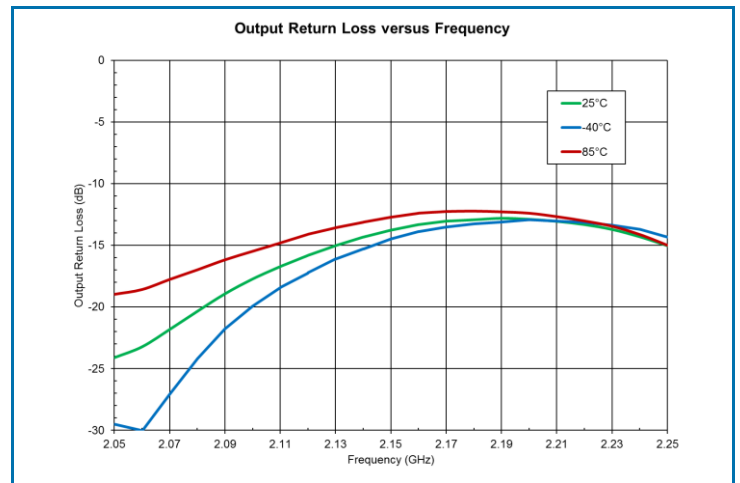
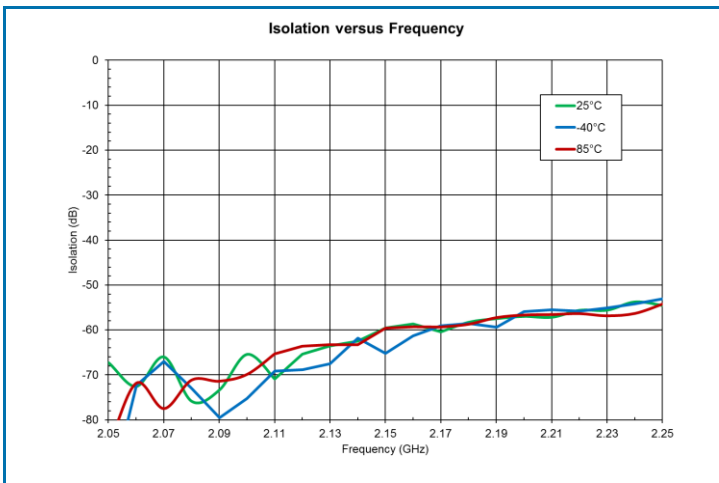
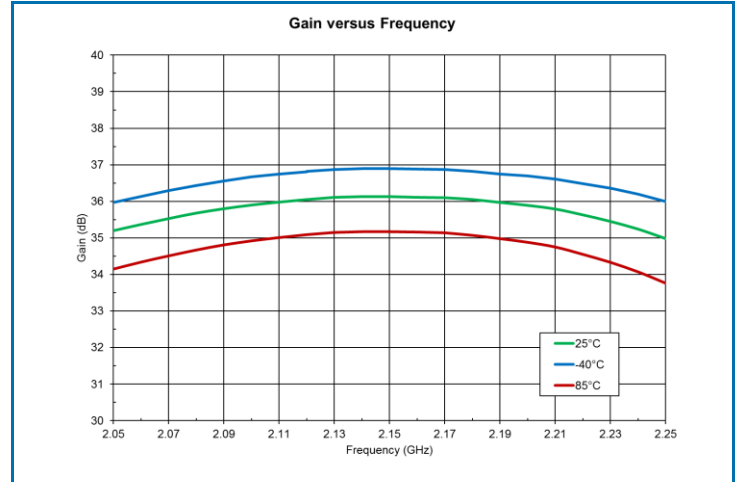
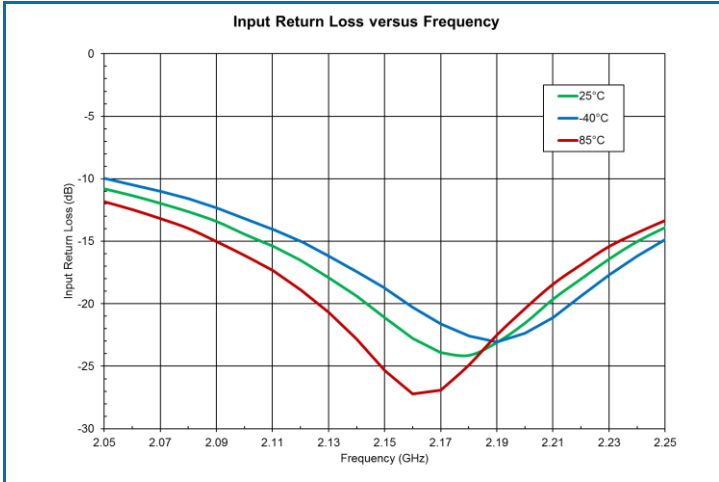

Typical Performance: $V_{CC} = V_{BIAS} = 5V$, $V_{EN} = 1.8V$
 2.11GHz to 2.17GHz Application Circuit

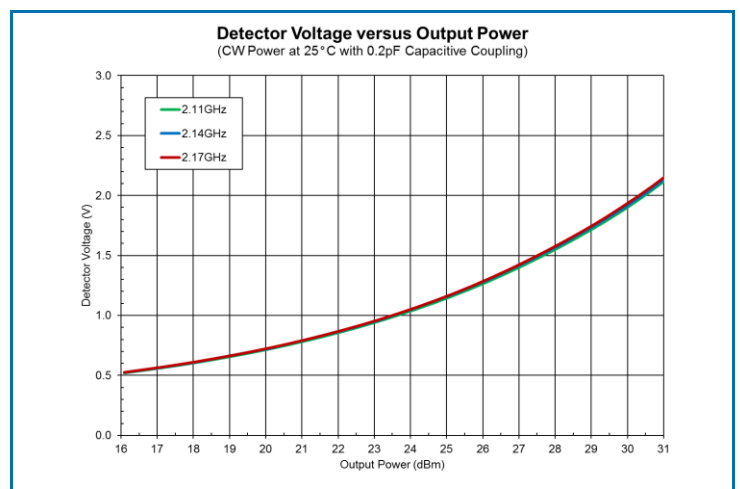
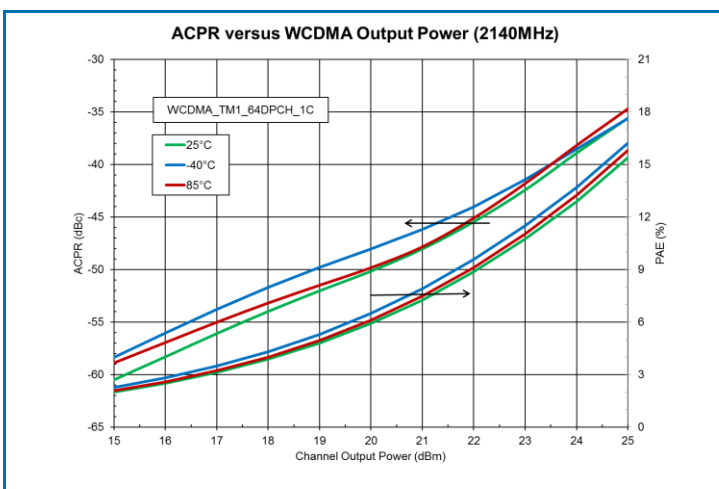
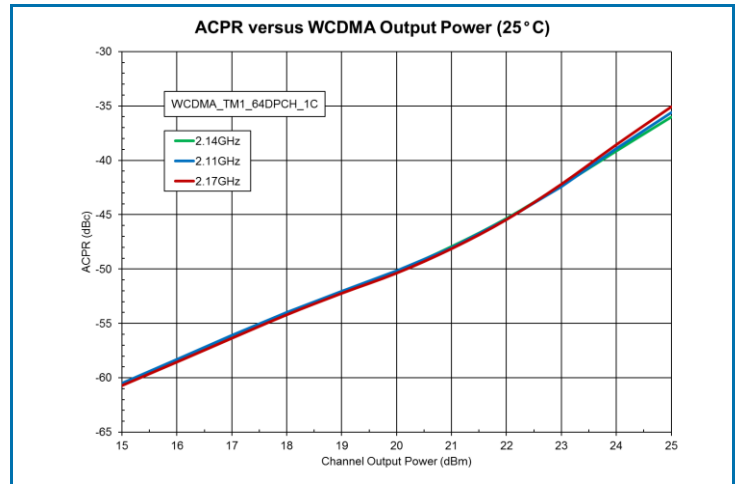
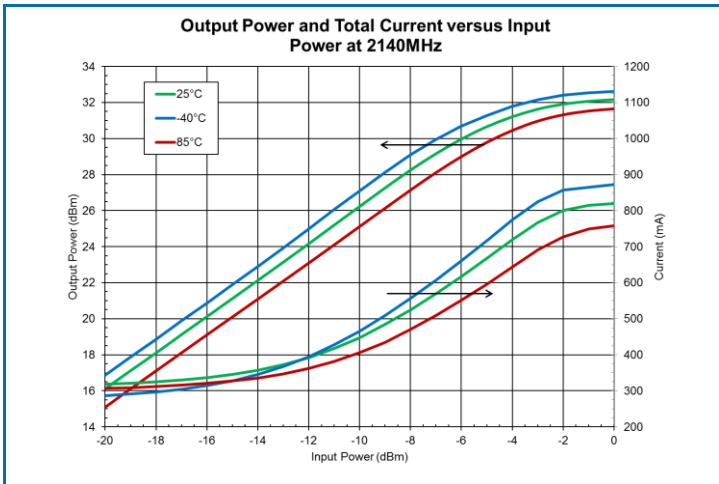
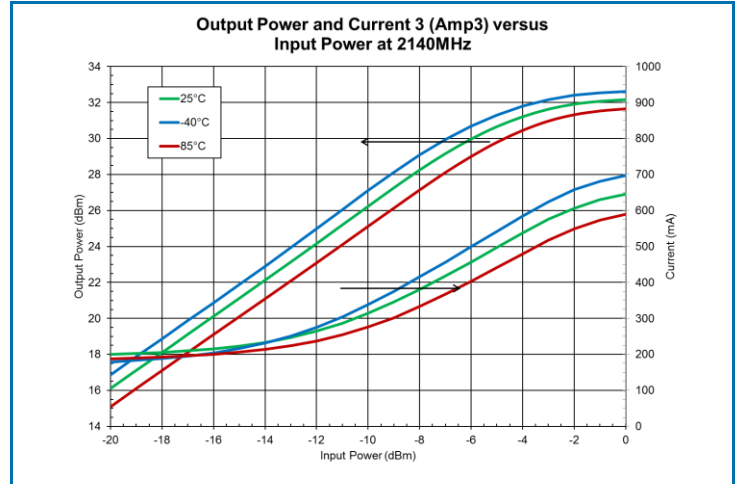
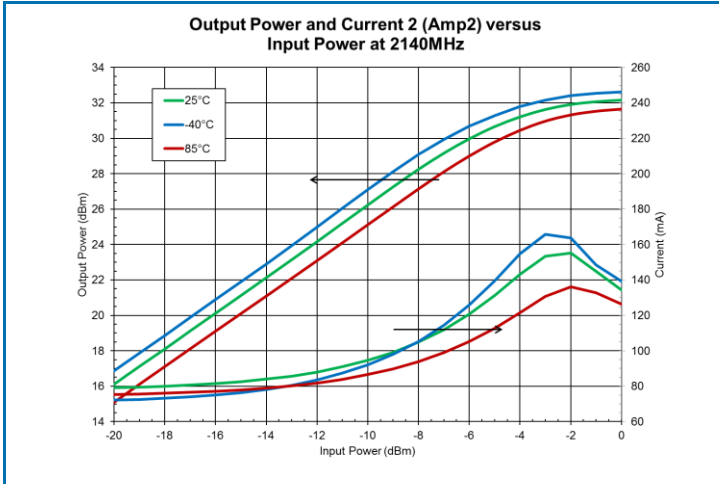

Typical Performance: $V_{CC} = V_{BIAS} = 5V$, $V_{EN} = 1.8V$
 2.11GHz to 2.17GHz Application Circuit

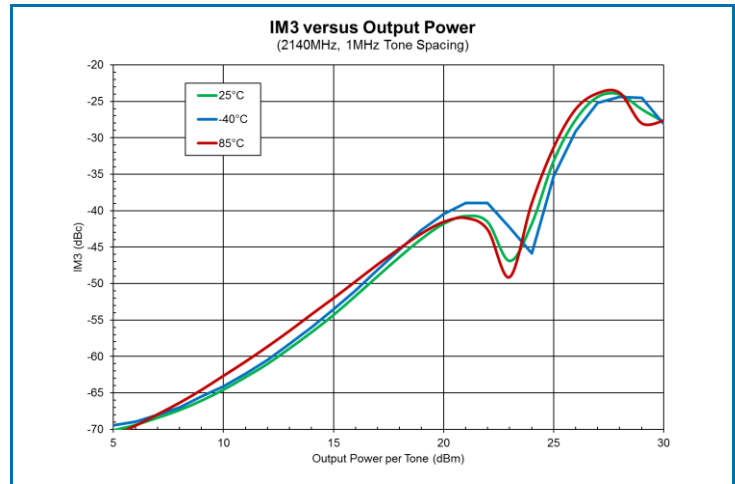
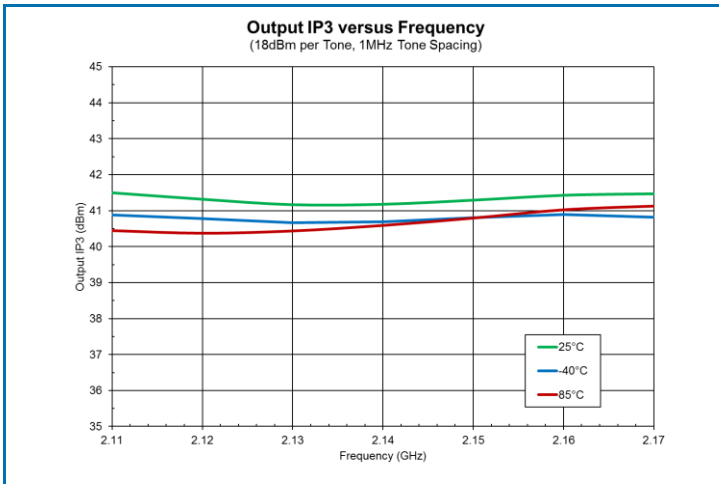
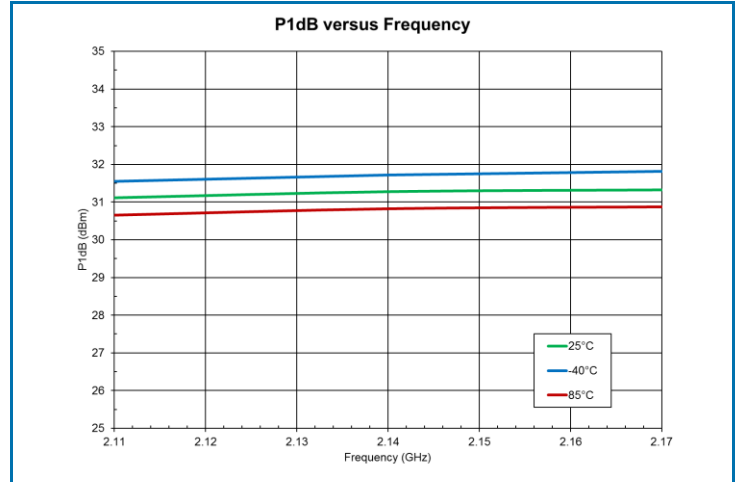
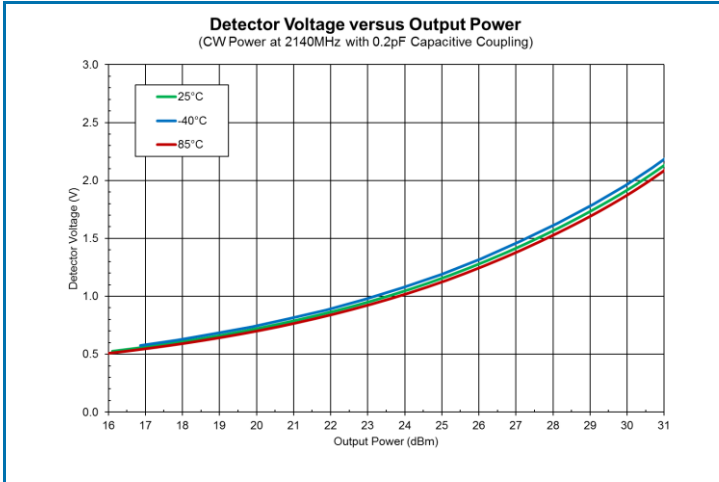

Evaluation Board Schematic 2.11GHz to 2.17GHz Application Circuit

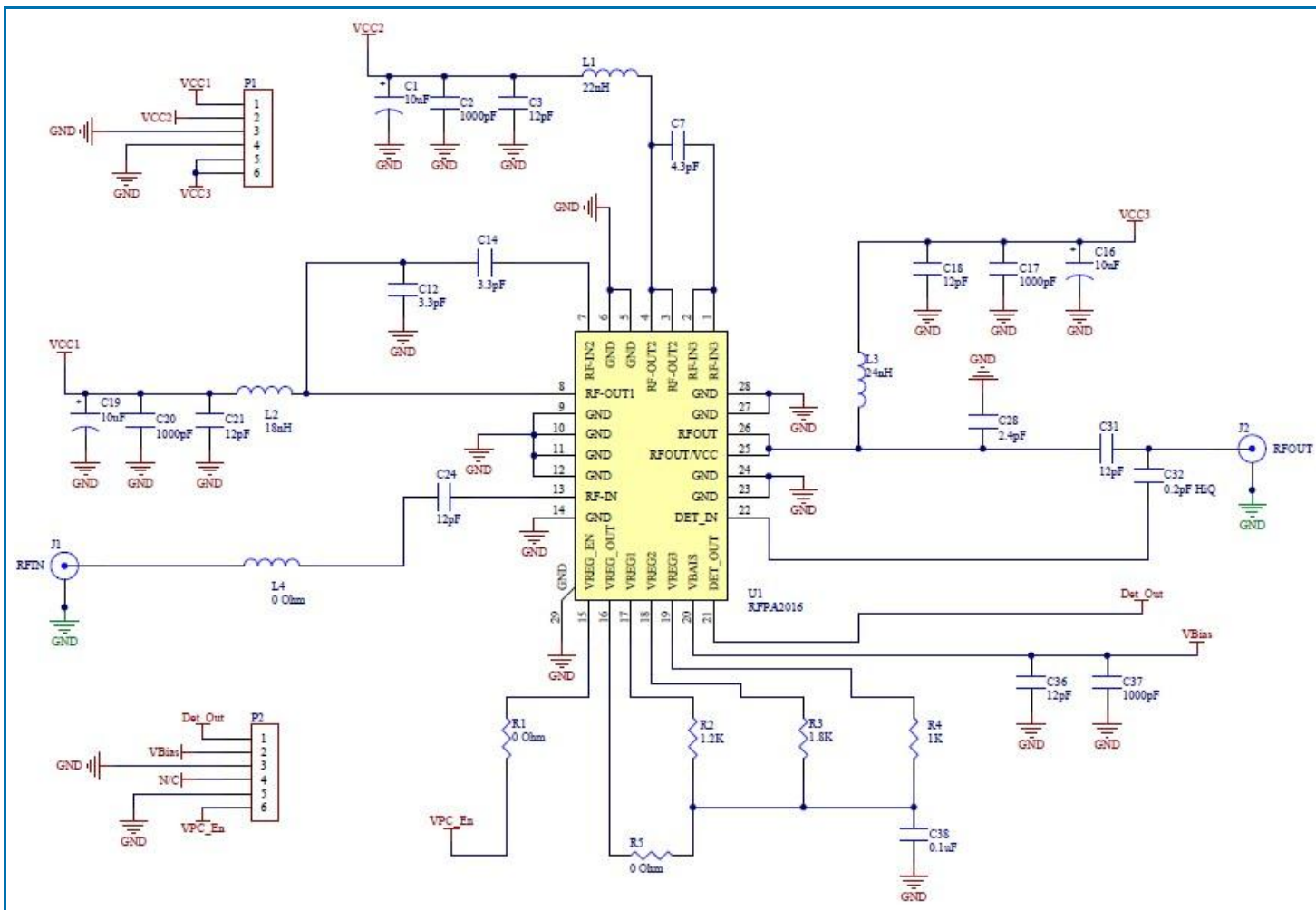

Evaluation Board Bill of Materials (BOM) 2.11GHz to 2.17GHz Application Circuit

Description	Reference Designator	Manufacturer	Manufacturer's P/N
RFPA2026 Evaluation Board		Dynamic Details (DDI) Toronto	RFPA2026-410(B)
700MHz to 2700MHz PA, 1W, 32dB Gain, Ext. Match	U1	RFMD	RFPA2016
CAP, 10 μ F, 10%, 10V, TANT-A	C1, C16, C19	AVX Corporation	TAJA106K010RNJ
CAP, 1000pF, 10%, 50V, X7R, 0402	C2, C17, C20, C37	Taiyo Yuden (USA), Inc.	RM UMK105BJ102KV-F
CAP, 12pF, 5%, 50V, C0G, 0402	C3, C18, C21, C24, C31, C36	Murata Electronics	GRM1555C1H120JZ01E
CAP, 4.3pF, +/-0.1pF, 50V, C0G, 0402	C7	Murata Electronics	GRM1555C1H4R3BA01D
CAP, 3.3pF, +/-0.1pF, 50V, C0G, 0402	C12, C14	Murata Electronics	GRM1555C1H3R3BA01D
CAP, 2.4pF, +/-0.1pF, 50V, HI-Q, 0402	C28	Murata Electronics	GJM1555C1H2R4BB01D
CAP, 0.2pF, +/-0.1pF, 50V, HI-Q, 0402	C32	Murata Electronics	GJM1555C1HR20BB01D
CAP, 0.1 μ F, 10%, 16V, X7R, 0402	C38	Murata Electronics	GRM155R71C104KA88D
CONN, SMA, 4-HOLE PANEL MOUNT JACK	J1-J2	Gigalane Co., Ltd.	PAF-S00-000
IND, 22nH, 5%, M/L, 0603	L1	Toko Inc.	LL1608-FSL22NJ
IND, 18nH, 5%, M/L, 0402	L2	Toko Inc.	LL1005-FH18NJ
IND, 24nH, 5%, W/W, 0603	L3	Coilcraft, Inc.	0603HC-24NXJLW
RES, 0 Ω , 0402	L4, R1, R5	Kamaya, Inc.	RMC1/16SJPTH
CONN, HDR, ST, PLRZD, 6-PIN, 0.100"	P1-P2	ITW Pancon	MPSS100-6-C
RES, 1.2K, 5%, 1/16W, 0402	R2	Kamaya, Inc.	RMC1/16S-122JTH
RES, 1.8K, 5%, 1/16W, 0402	R3	Kamaya, Inc.	RMC1/16S-182JTH
Res, 1K, 5%, 1/16W, 0402	R4	Kamaya, Inc.	RMC1/16S-102JTH
HEATSINK, BLOCK, TEST FIX, 1.5" x 2.0"		Wells Machining	EEF-101217
SCREW, 2-56 x 3/16", SOCKET HEAD	S1-S9	McMaster-Carr Supply Co.	92196A076

Evaluation Board Assembly Drawing 2.11GHz to 2.17GHz Application Circuit

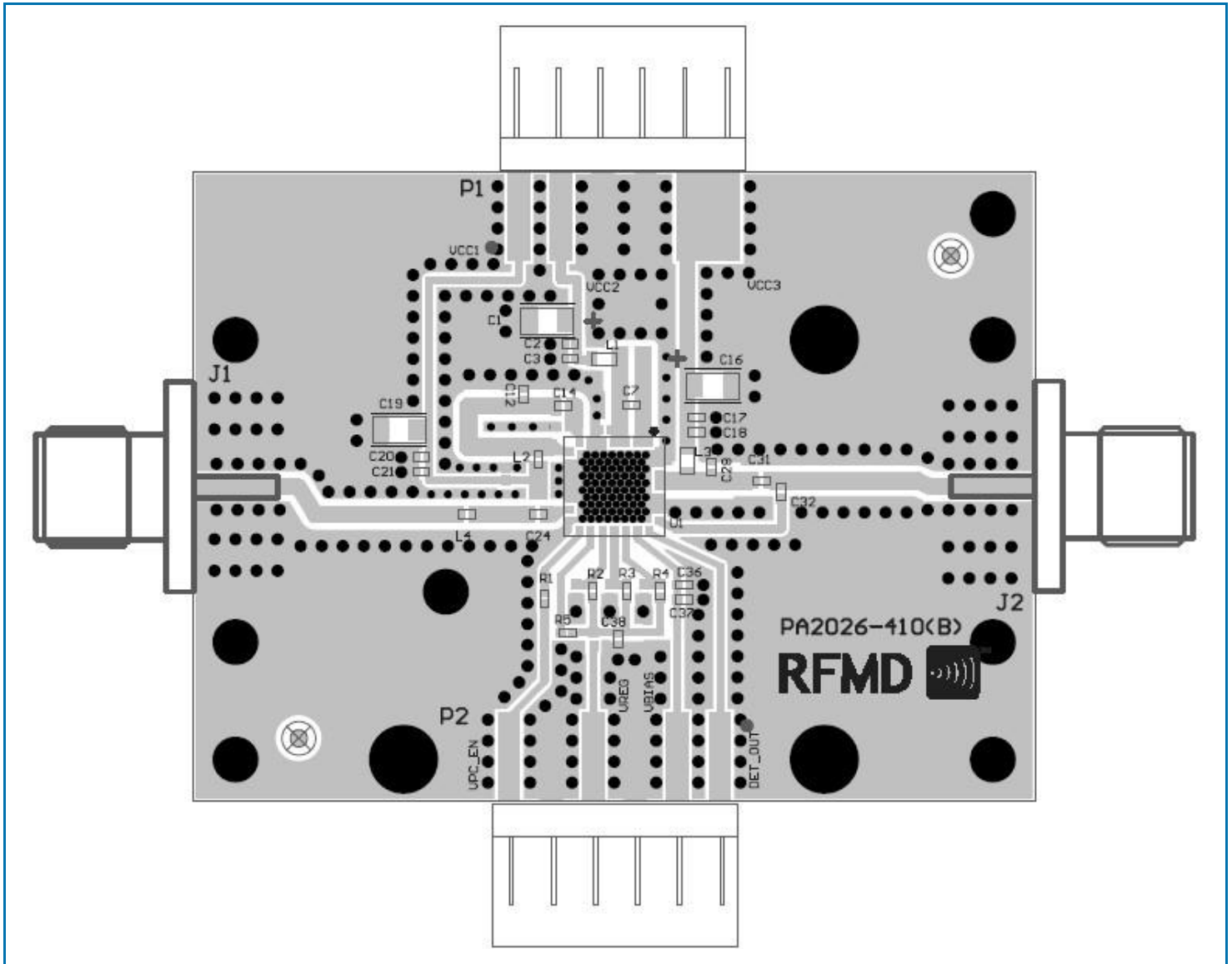

Typical Performance: $V_{CC} = V_{BIAS} = 5V$, $V_{EN} = 1.8V$
 2.62GHz to 2.69GHz Application Circuit

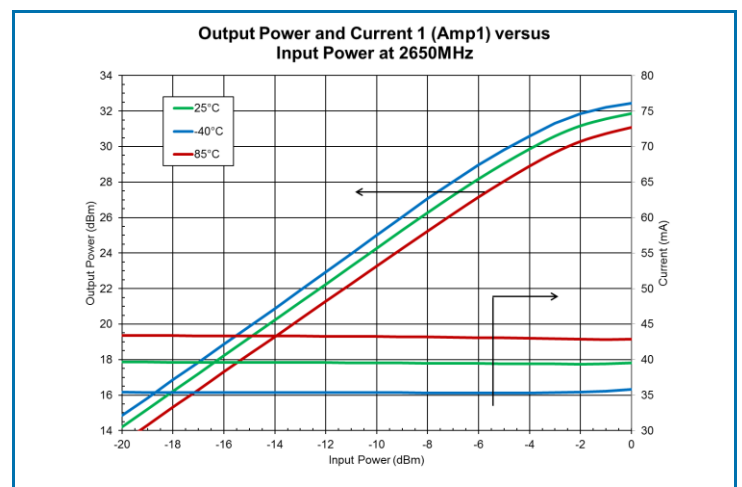
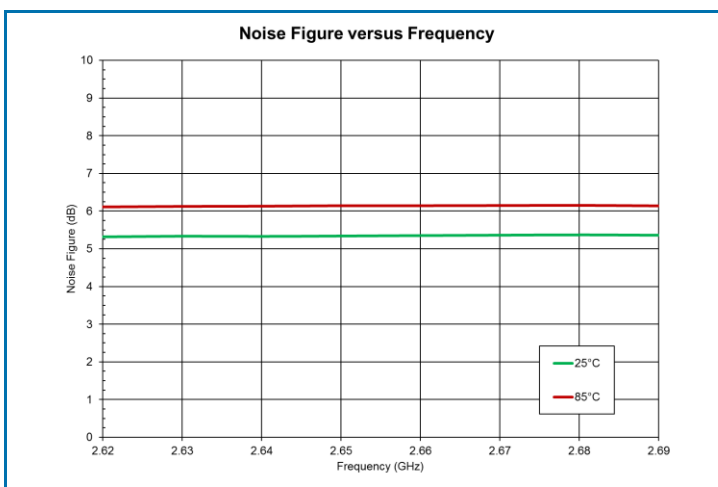
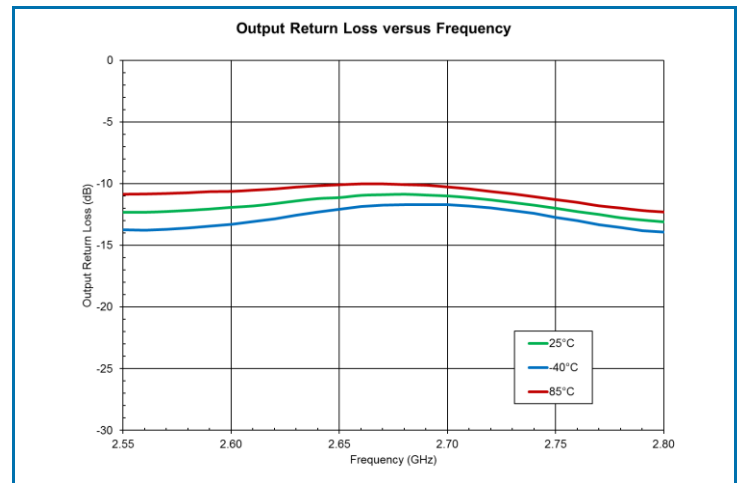
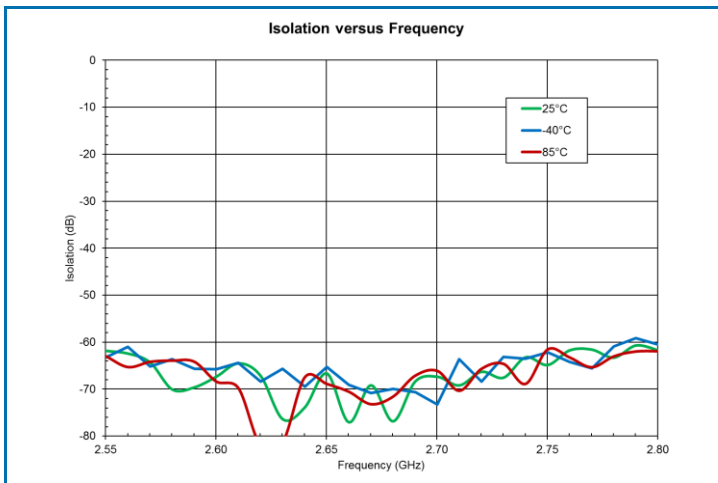
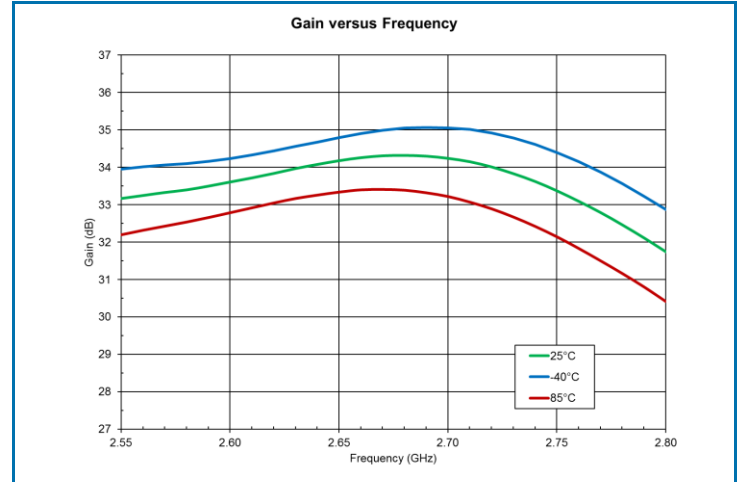
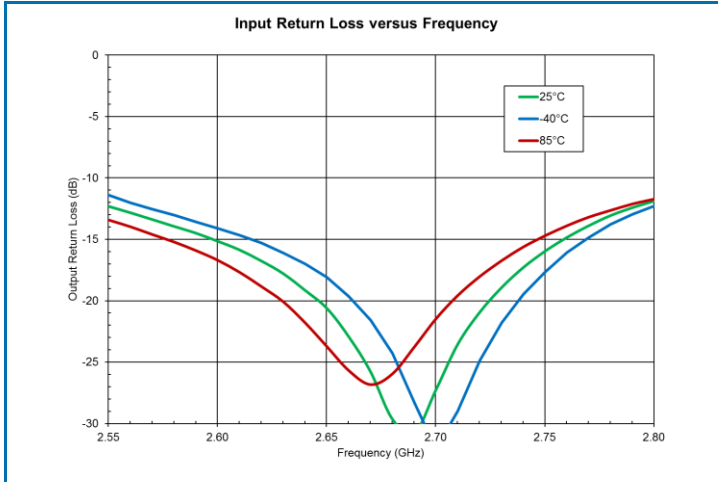

Typical Performance: $V_{CC} = V_{BIAS} = 5V$, $V_{EN} = 1.8V$
 2.62GHz to 2.69GHz Application Circuit

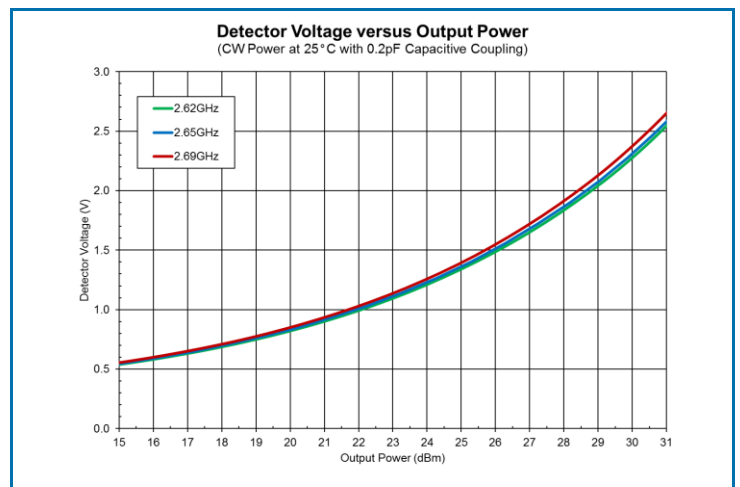
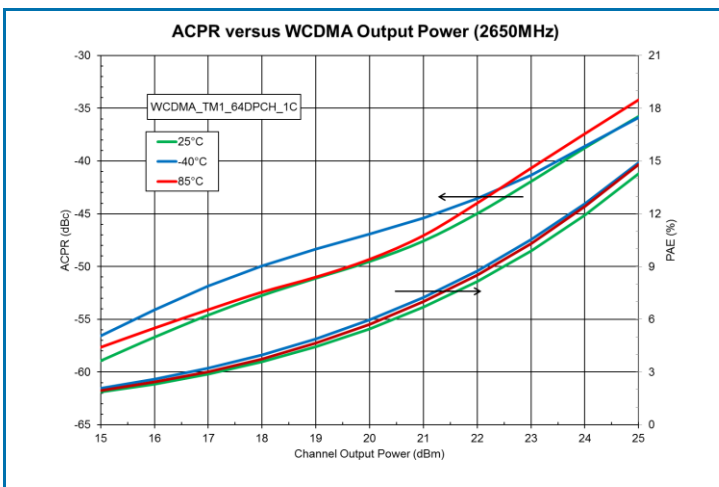
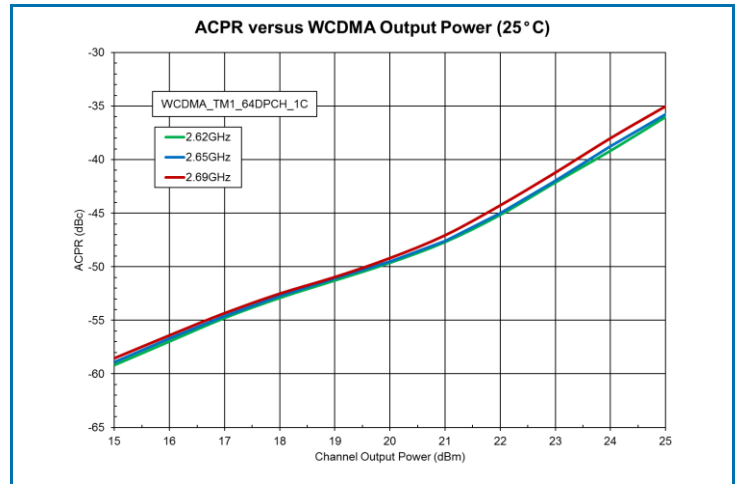
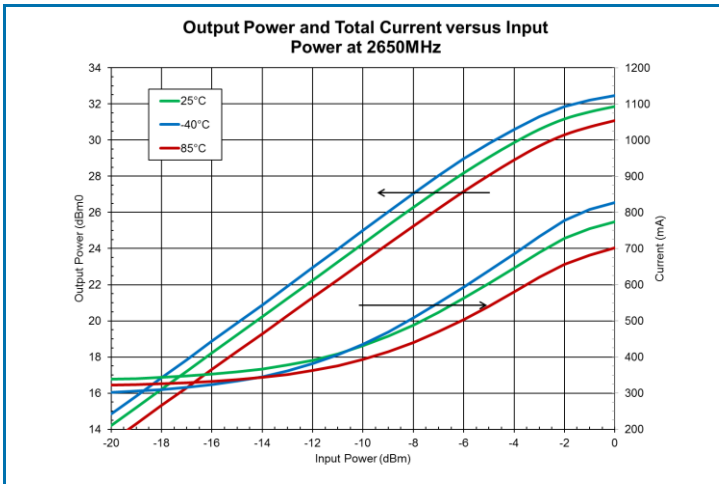
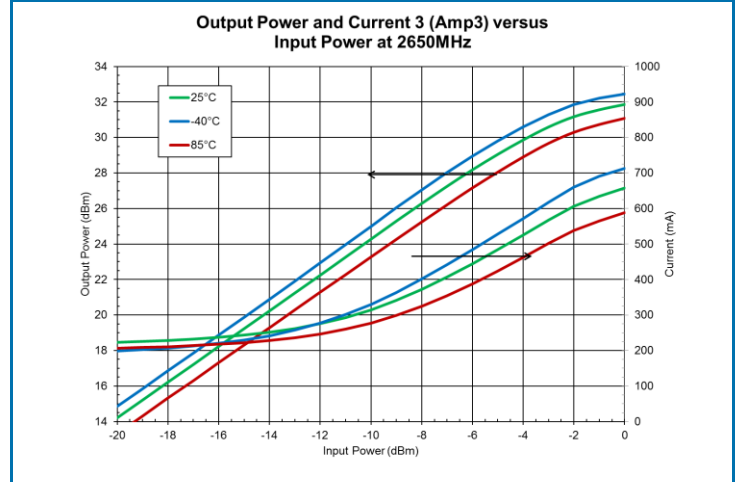
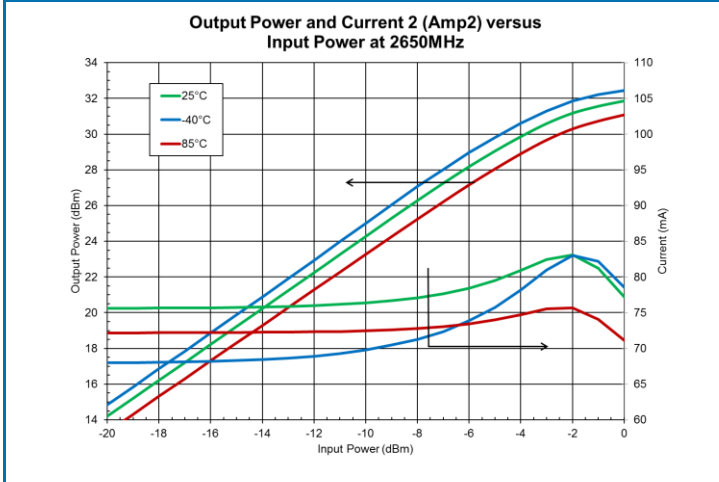

Typical Performance: $V_{CC} = V_{BIAS} = 5V$, $V_{EN} = 1.8V$
 2.62GHz to 2.69GHz Application Circuit

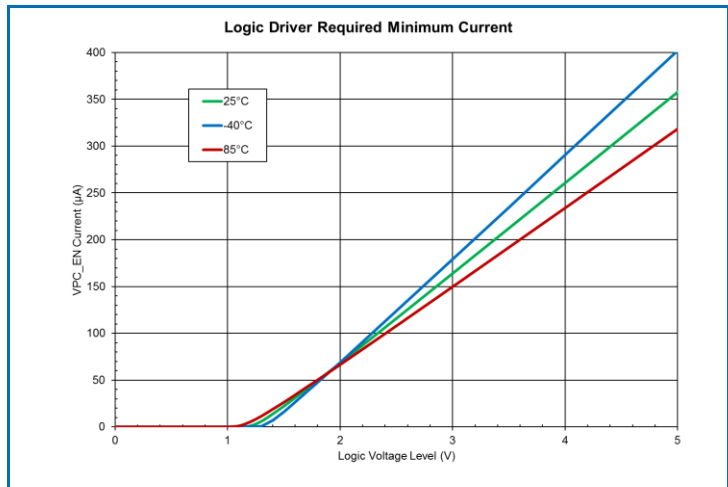
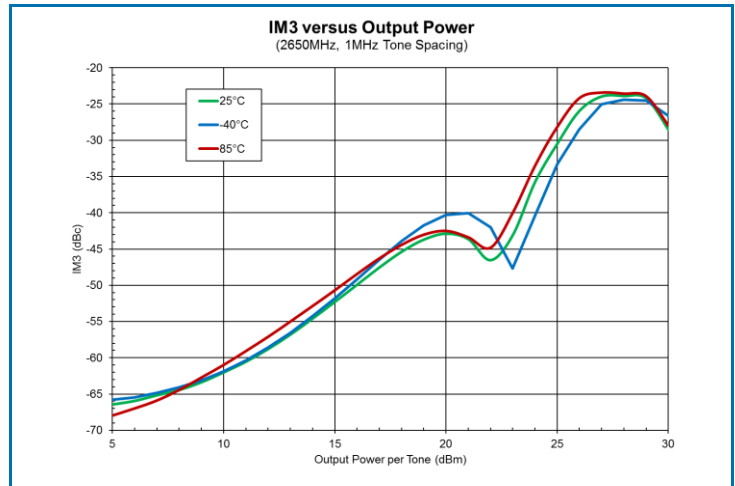
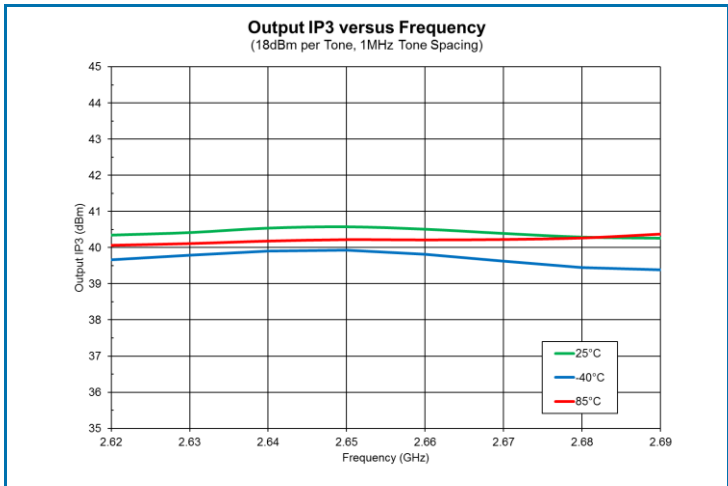
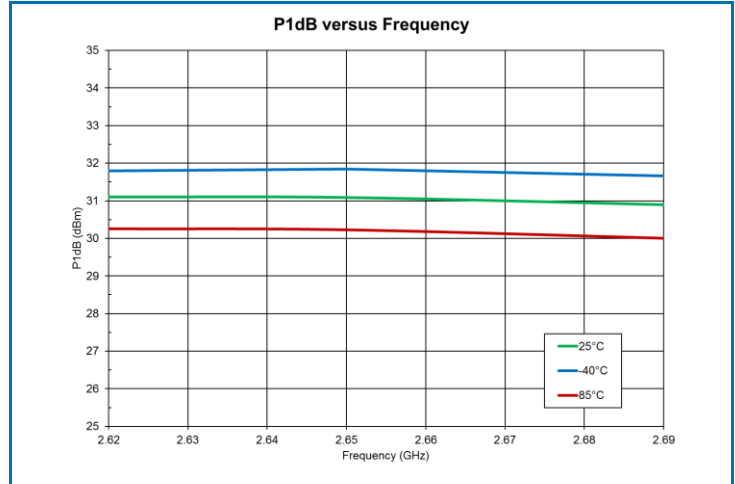
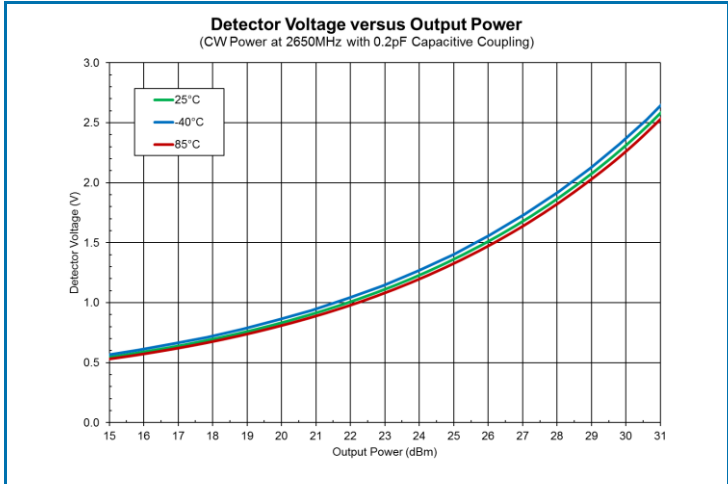

Evaluation Board Schematic 2.62GHz to 2.69GHz Application Circuit

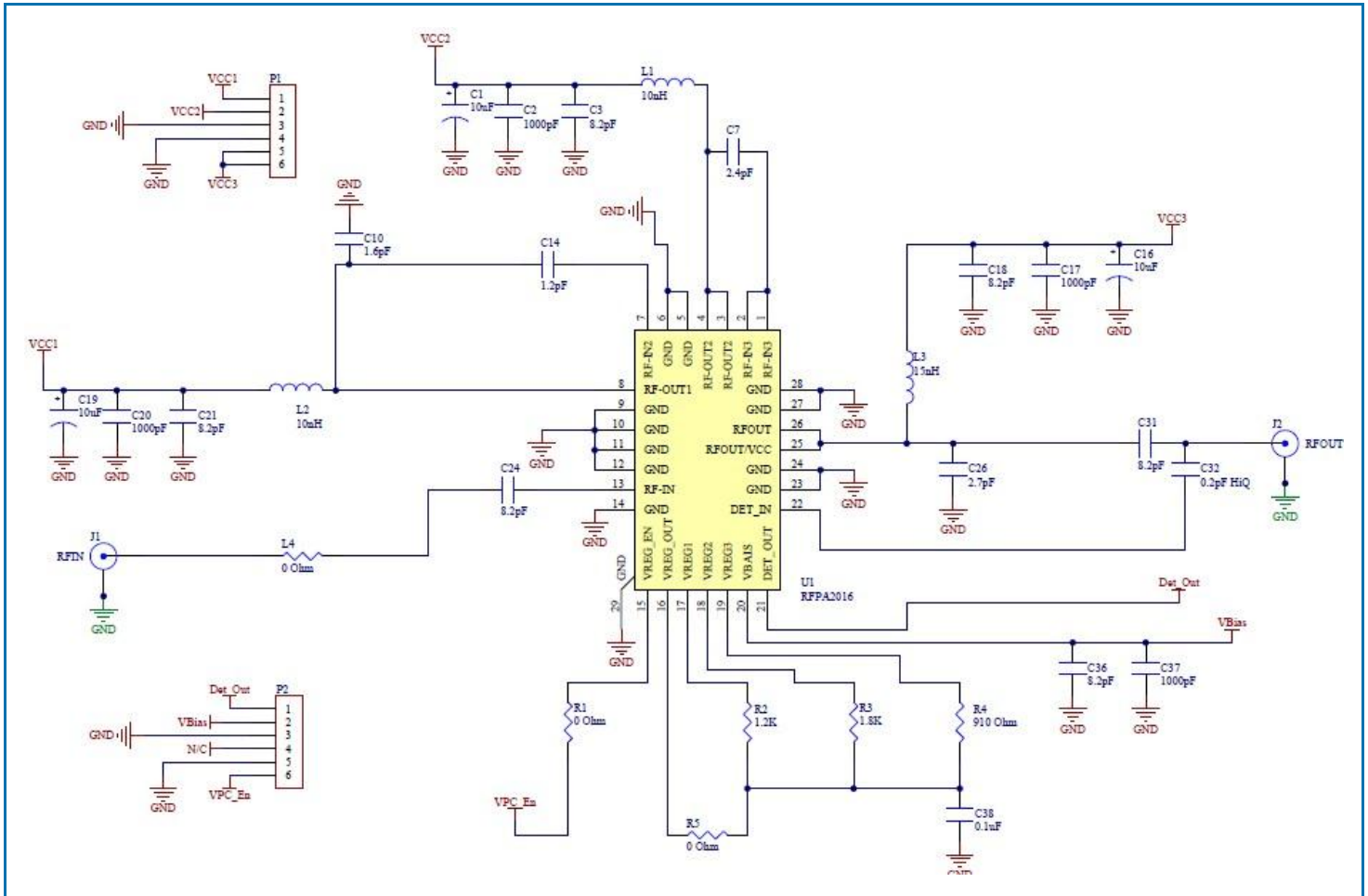

Evaluation Board Bill of Materials (BOM) 2.62GHz to 2.69GHz Application Circuit

Description	Reference Designator	Manufacturer	Manufacturer's P/N
RFPA2026 Evaluation Board		Dynamic Details (DDI) Toronto	RFPA2026-410(B)
700MHz to 2700MHz PA, 1W, 32dB Gain, Ext. Match	U1	RFMD	RFPA2016
CAP, 10 μ F, 10%, 10V, TANT-A	C1, C16, C19	AVX Corporation	TAJA106K010RNJ
CAP, 1000pF, 10%, 50V, X7R, 0402	C2, C17, C20, C37	Taiyo Yuden (USA), Inc.	RM UMK105BJ102KV-F
CAP, 8.2pF, 5%, 50V, C0G, 0402	C3, C18, C21, C24, C31, C36	Murata Electronics	GRM1555C1H8R2DA01D
CAP, 2.4pF, +/-0.5pF, 50V, C0G, 0402	C7	Murata Electronics	GRM1555C1H2R4DBA01D
CAP, 1.6pF, +/-0.1pF, 50V, C0G, 0402	C10	Murata Electronics	GRM1555C1H1R6BA01D
CAP, 1.2pF, +/-0.1pF, 50V, C0G, 0402	C14	Murata Electronics	GRM1555C1H1R2BA01D
CAP, 2.7pF, +/-0.1pF, 50V, C0G, 0402	C26	Murata Electronics	GRM1555C1H2R7BA01D
CAP, 0.2pF, +/-0.1pF, 50V, HI-Q, 0402	C32	Murata Electronics	GJM1555C1HR20BB01D
CAP, 0.1 μ F, 10%, 16V, X7R, 0402	C38	Murata Electronics	GRM155R71C104KA88D
CONN, SMA, 4-HOLE PANEL MOUNT JACK	J1-J2	Gigalane Co., Ltd.	PAF-S00-000
IND, 10nH, 5%, M/L, 0603	L1	Toko Inc.	LL1608-FSL10NJ
IND, 10nH, 5%, M/L, 0402	L2	Toko Inc.	LL1005-FH10NJ
IND, 15nH, 5%, W/W, 0603	L3	Coilcraft, Inc.	0603HC-15NXJB
RES, 0 Ω , 0402	L4, R1, R5	Kamaya, Inc.	RMC1/16SJPTH
CONN, HDR, ST, PLRZD, 6-PIN, 0.100"	P1-P2	ITW Pancon	MPSS100-6-C
RES, 1.2K, 5%, 1/16W, 0402	R2	Kamaya, Inc.	RMC1/16S-122JTH
RES, 1.8K, 5%, 1/16W, 0402	R3	Kamaya, Inc.	RMC1/16S-182JTH
RES, 910 Ω , 5%, 1/16W, 0402	R4	Panasonic Industrial Devices	ERJ-2GEJ911X
HEATSINK, BLOCK, TEST FIX, 1.5" x 2.0"		Wells Machining	EEF-101217
SCREW, 2-56 x 3/16", SOCKET HEAD	S1-S9	McMaster-Carr Supply Co.	92196A076

Evaluation Board Assembly Drawing 2.62GHz to 2.69GHz Application Circuit

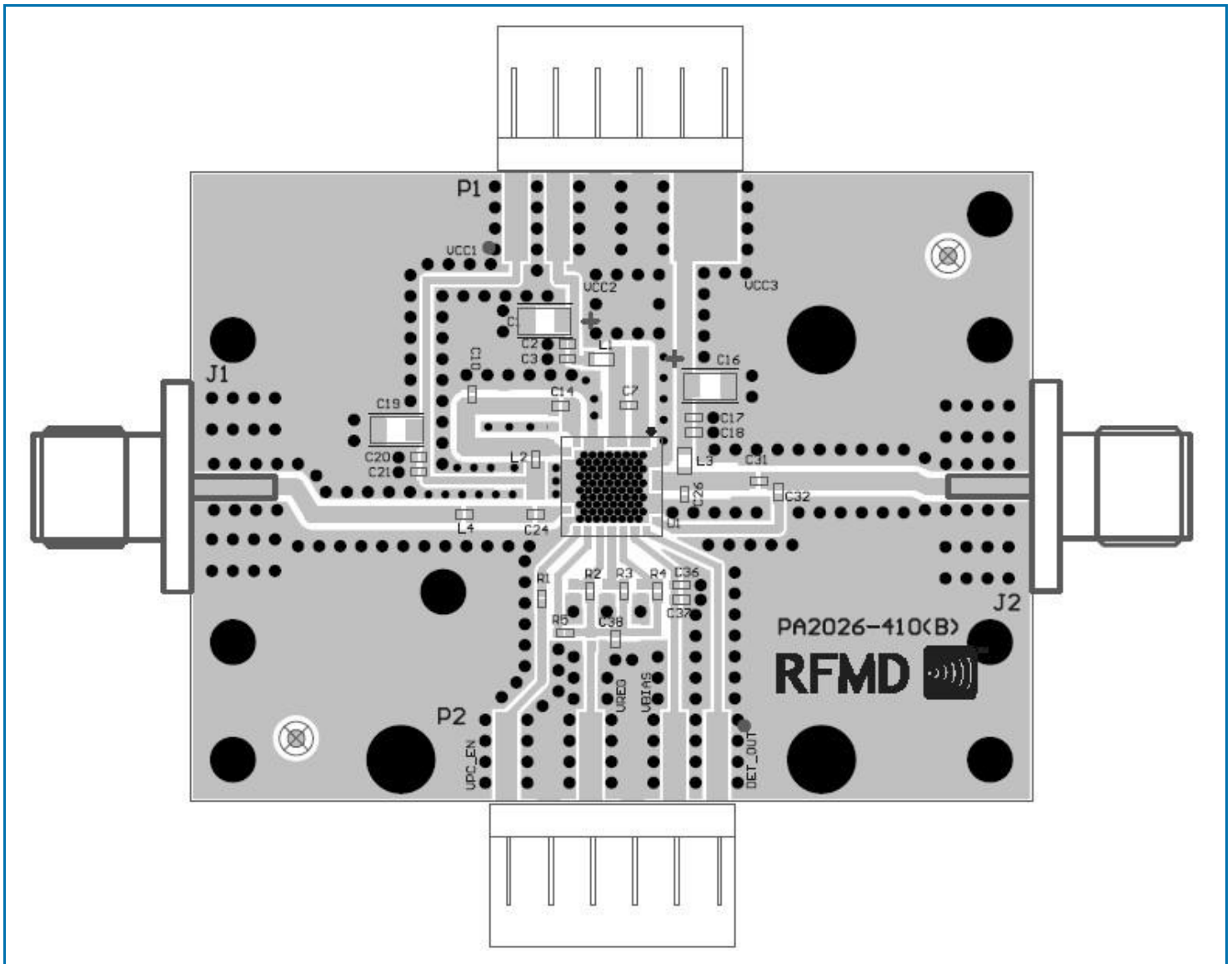

Pin Names and Descriptions

Pin	Name	Description
1	RFIN3	RF Input for stage 3, must be DC blocked
2	RFIN3	RF Input for stage 3, must be DC blocked
3	RFOUT2/VCC2	RF Output and collector supply for stage 2
4	RFOUT2/VCC2	RF Output and collector supply for stage 2
5	GND	Ground
6	GND	Ground
7	RFIN2	RF Input for stage 2, must be DC blocked
8	RFOUT1/VCC1	RF Output and collector supply for stage 1
9	GND	Ground
10	GND	Ground
11	GND	Ground
12	GND	Ground
13	RFIN1	RF Input for stage 1, must be DC blocked
14	GND	Ground
15	VPC_EN	V _{PC} enable (low = shutdown)
16	VPC_OUT	V _{PC} output to amplifier V _{REG} resistors
17	VREG1	Stage 1 V _{REG}
18	VREG2	Stage 2 V _{REG}
19	VREG3	Stage 3 V _{REG}
20	VBIAS	V _{CC} supply to detector V _{PC} switch, and amplifier V _{BIAS} pins
21	DET_OUT	Detector output voltage
22	DET_IN	RF Input to detector
23	GND	Ground
24	GND	Ground
25	RFOUT3/VCC3	RF Output and collector supply for stage 3
26	RFOUT3/VCC3	RF Output and collector supply for stage 3
27	GND	Ground
28	GND	Ground

Package Drawing (Dimensions in millimeters)

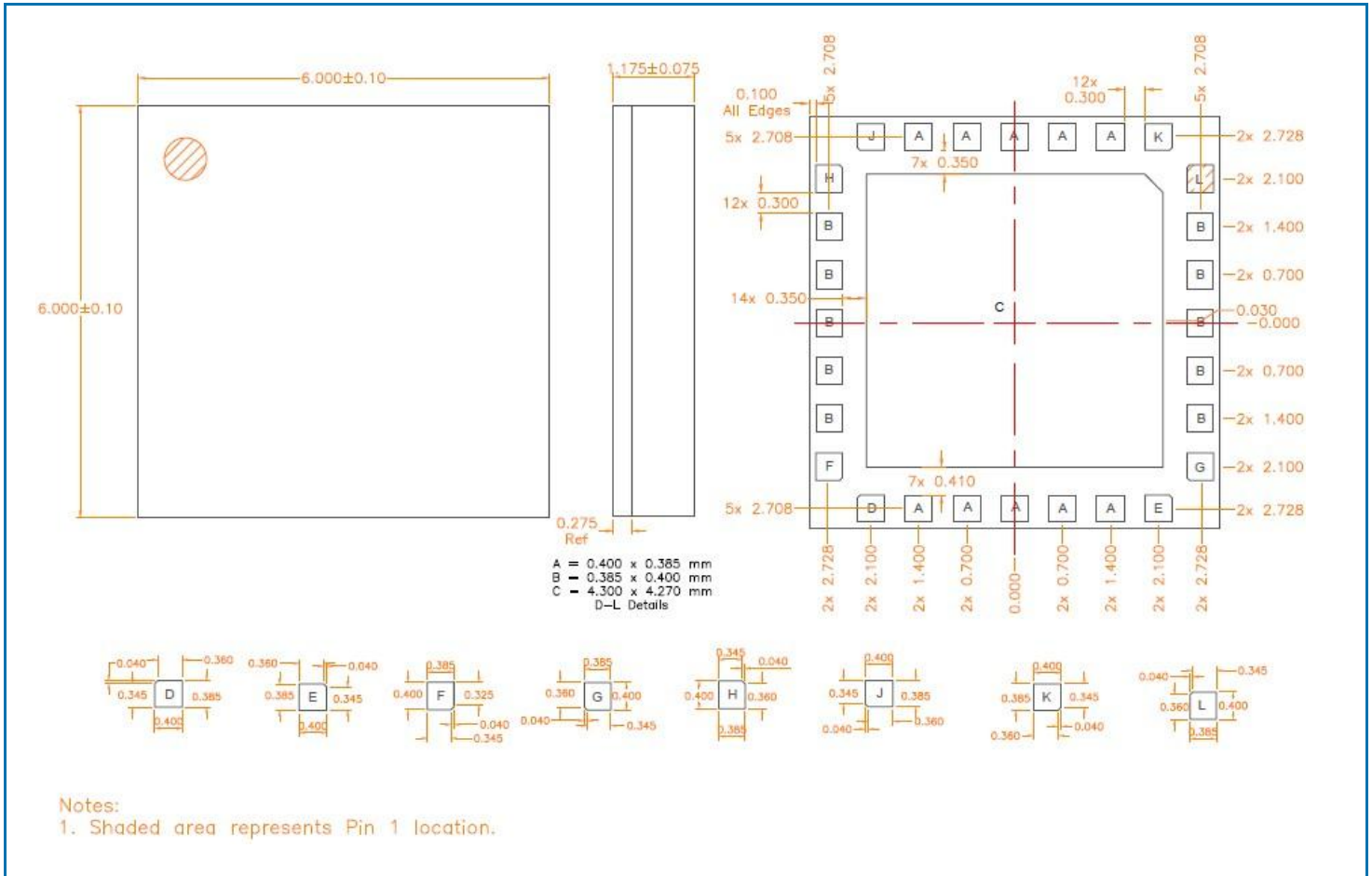

Branding Diagram

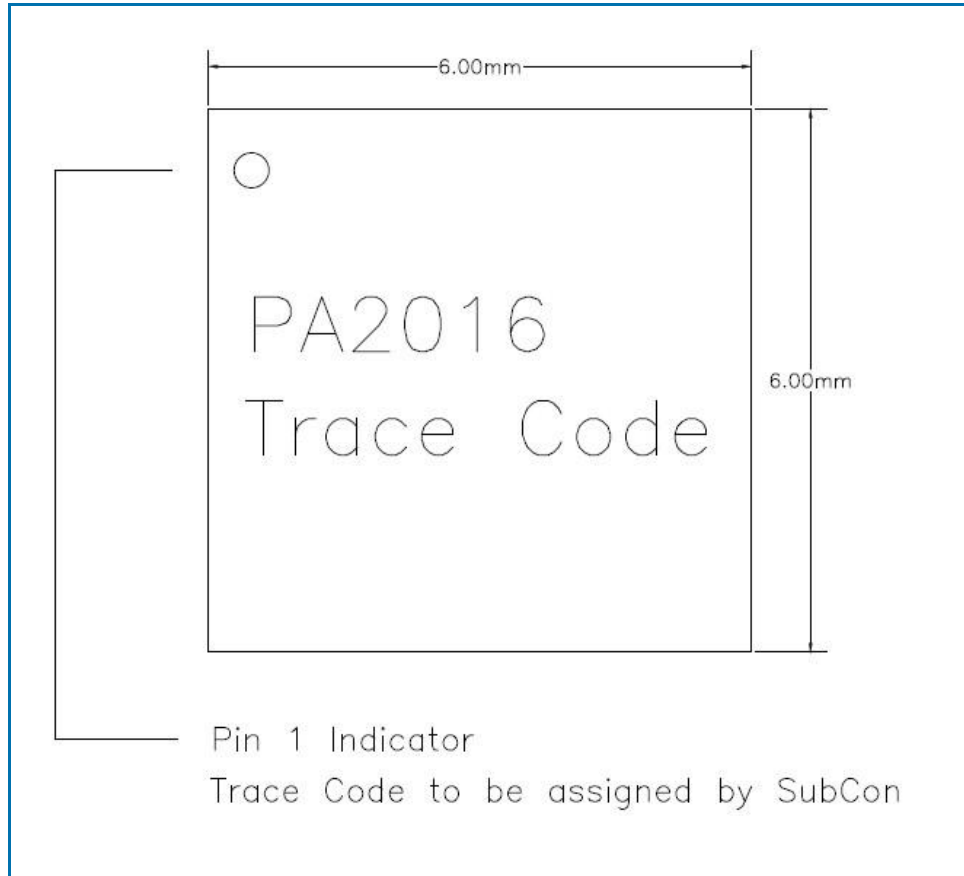

X-ON Electronics

Largest Supplier of Electrical and Electronic Components

Click to view similar products for [RF Amplifier](#) category:

Click to view products by [Qorvo](#) manufacturer:

Other Similar products are found below :

[A82-1](#) [BGA622H6820XTSA1](#) [BGA 728L7 E6327](#) [BGB719N7ESDE6327XTMA1](#) [HMC397-SX](#) [HMC405](#) [HMC561-SX](#) [HMC8120-SX](#)
[HMC8121-SX](#) [HMC-ALH382-SX](#) [HMC-ALH476-SX](#) [SE2433T-R](#) [SMA3101-TL-E](#) [SMA39](#) [A66-1](#) [A66-3](#) [A67-1](#) [LX5535LQ](#) [LX5540LL](#)
[MAAM02350](#) [HMC3653LP3BETR](#) [HMC549MS8GETR](#) [HMC-ALH435-SX](#) [SMA101](#) [SMA32](#) [SMA411](#) [SMA531](#) [SST12LP19E-QX6E](#)
[WPM0510A](#) [HMC5929LS6TR](#) [HMC5879LS7TR](#) [HMC1126](#) [HMC1087F10](#) [HMC1086](#) [HMC1016](#) [SMA1212](#) [MAX2689EWS+T](#)
[MAAMSS0041TR](#) [MAAM37000-A1G](#) [LTC6430AIUF-15#PBF](#) [SMA70-2](#) [SMA4011](#) [A231](#) [HMC-AUH232](#) [LX5511LQ](#) [LX5511LQ-TR](#)
[HMC7441-SX](#) [HMC-ALH310](#) [XD1001-BD-000V](#) [A4011](#)