

### Product Overview

Qorvo's RFSA2023 is a fully monolithic analog voltage control attenuator (VCA) featuring exceptional linearity over 30dB adjustment range with on-chip temperature compensation.

RFSA2023 incorporates a revolutionary new circuit architecture. It solved the long-standing industry problems of IP3, attenuation range, DC current, bandwidth, and temperature compensation. RFSA2023 is also designed with linear in dB control characteristic. There is no external analog supporting circuitry required. This attenuator is controlled by a single positive variable voltage with DC conditioning circuitry also on-chip. The slope of the attenuation versus control voltage is selectable. The RFSA2023 draws only 1mA current. It is internally matched to 50 Ω and works quite well over its rated ranges of control voltage and frequency.

This game-changing product integrates the complete solution into a small 3mm x 3mm QFN package. That reduces the footprint by 20X in area and reduces the DC power by 10X over the PIN diode approaches.

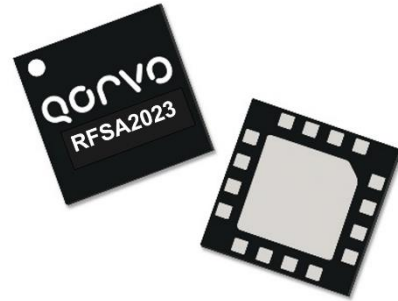

16 Pad 3 x 3 mm QFN Package

### Key Features

- Broadband 50MHz to 6000 MHz
- 30 dB Attenuation Range
- +50 dBm Input IP3
- +80 dBm Input IP2
- >+30 dBm High 1 dB Compression
- 1mA Low Current Consumption
- 3.3V Power Supply
- Linear in dB Control Characteristic
- Internal Temperature Compensation
- 5V Version Available - RFSA2013

### Functional Block Diagram

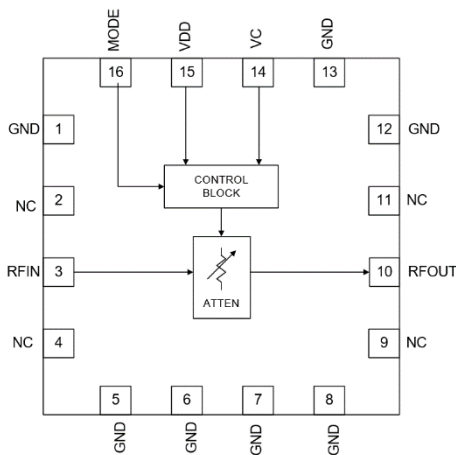

Top View

### Applications

- Cellular, 3G Infrastructure
- WiBro, WiMax, LTE
- Microwave Radio
- High Linearity Power Control

### Ordering Information

Part No.	Description
RFSA2023TR7	2,500 pieces on a 7" reel (standard)
RFSA2023PCK-410	50–6000 MHz Evaluation Board with 5-piece sample bag

## Absolute Maximum Ratings

Parameter	Rating
Storage Temperature	-65 to +150 °C
RF Input Power, CW, 50 Ω, T=25 °C	+30 dBm
Device Voltage (VDD) Control Voltage (VC) Mode Select Voltage (MODE)	-0.5 to +4 V

Exceeding any one or a combination of the Absolute Maximum Rating conditions may cause permanent damage to the device. Extended application of Absolute Maximum Rating conditions to the device may reduce device reliability.

## Recommended Operating Conditions

Parameter	Min	Typ	Max	Units
Device Voltage (VDD)	+3.0	+3.3	+3.5	V
Device Current (IDD)		1		mA
RF Input Power (RFIN)			27	dBm
T <sub>CASE</sub>	-40		+85	°C
T <sub>j</sub>			+125	°C

Electrical specifications are measured at specified test conditions. Specifications are not guaranteed over all recommended operating conditions.

## Electrical Specifications

Parameter	Conditions <sup>(1)</sup>	Min	Typ	Max	Units
Operational Frequency Range		50		6000	MHz
Test Frequency			2000		MHz
Minimum Attenuation	Insertion loss		2.6	3.5	dB
Attenuation Adjustment Range		30	33.2		dB
Attenuation Variation	Over temperature with a fixed VC		1.7		dB
Relative Insertion Phase	At 15 dB attenuation relative to the phase at minimum attenuation		15.9		°
Input / Output Return Loss			15		dB
Input P1dB			30		dBm
Input IP3	Pin + (IMD3 <sub>dBc</sub> / 2)	45	50		dBm
Input IP2	Pin + IMD2 <sub>dBc</sub> , IMD2 is F1 + F2		80		dBm
Input IH2	Pin + H2 <sub>dBc</sub> , H2 is second harmonic		85		dBm
Input IH3	Pin + (H3 <sub>dBc</sub> / 2), H3 is third harmonic		55		dBm
Control Voltage Range	VC	0.0		2.5	V
VC Control Current	MODE Logic High, and VC 2.5V		1.1		μA
	MODE Logic Low, and VC 2.5V		1.7		μA
Mode Select Voltage	Logic Low			0.4	V
	Logic High	1.0			V
Setting Time	1dB attenuation adjustment to steady state error ≤ 0.1 dB		15		μs
Thermal Resistance, θ <sub>jc</sub>	Junction to case; RF input at RFIN pin		45		°C/W

Notes:

1. Test conditions unless otherwise noted: VDD = +3.3 V, Temperature = +25 °C, RF Frequency 2 GHz, 50 Ω system.

## Mode Select Table

MODE Logic	MODE Voltage	Attenuator S21 Slope	VC, Minimum Attenuation
High	≥ 1.0 V	Positive	2.5 V
Low	≤ 0.4 V	Negative	0.0 V

**50 MHz to 6000 MHz Evaluation Board – RFSA2023PCK-410**

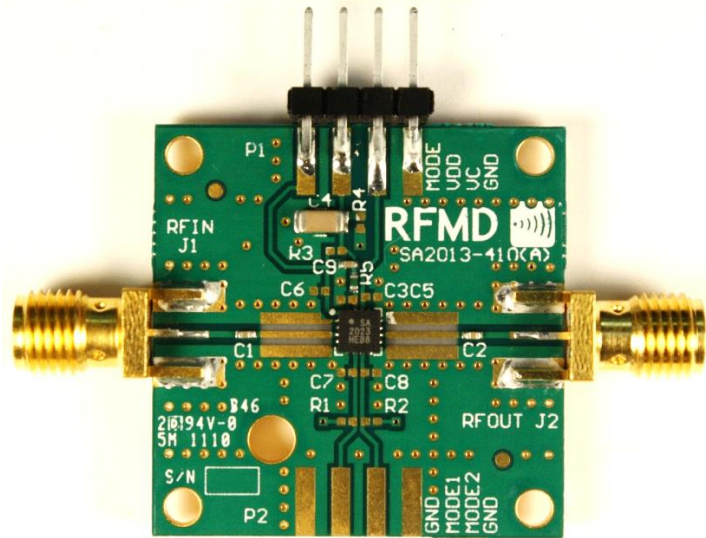

Evaluation Board Assembly Top View

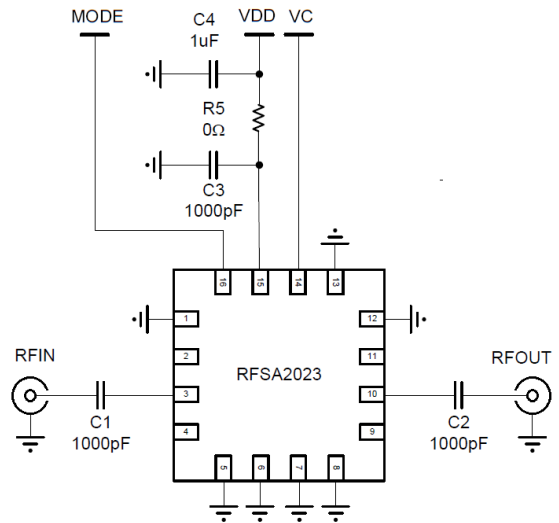

Evaluation Board Schematic

**Bill of Material – RFSA2023PCK-410**

Ref. Des.	Value	Description	Manuf.	Part Number
PCB	-	PCB, Printed Circuit Board, SA2013-410	Qorvo	
U1	-	VCA, Voltage Control Attenuator, 3.3 V	Qorvo	RFSA2023
J1, J2	-	CONN, SMA End LNCH MINI FLT, 0.068"	Emerson	142-0741-851
P1	-	CONN, HDR, ST, 4-PIN, 0.100", T/H	MOLEX	22-28-4043
C1, C2, C3	1000 pF	CAP, 1000pF, 10%, 25V, X7R, 0402	Murata	GRM155R71H102KA01D
C4	1.0 μF	CAP, 1.0 μF, 10%, 25V, X7R, 1206	Murata	GRM31MR71E105KA01L
R5	0 Ω	RES, 0 Ω, 5%, 0402	Kamaya	RMC1/16SJPTH

## Performance Plots – Positive S21 Slope

Test conditions unless otherwise noted:  $V_{DD} = +3.3V$ , Temp.=+25°C, EVB trace and connector losses included

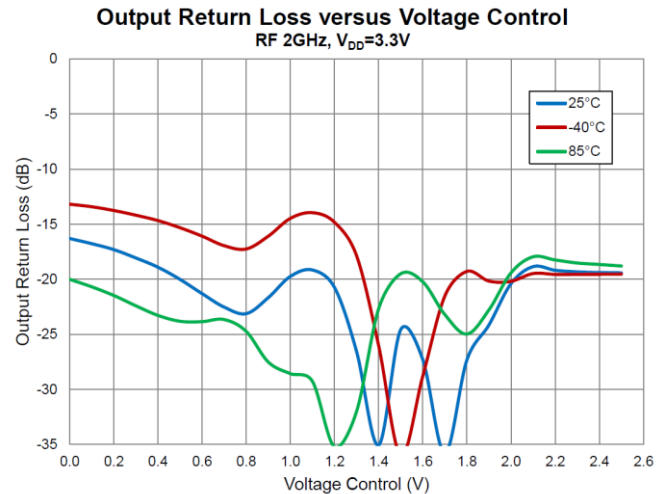
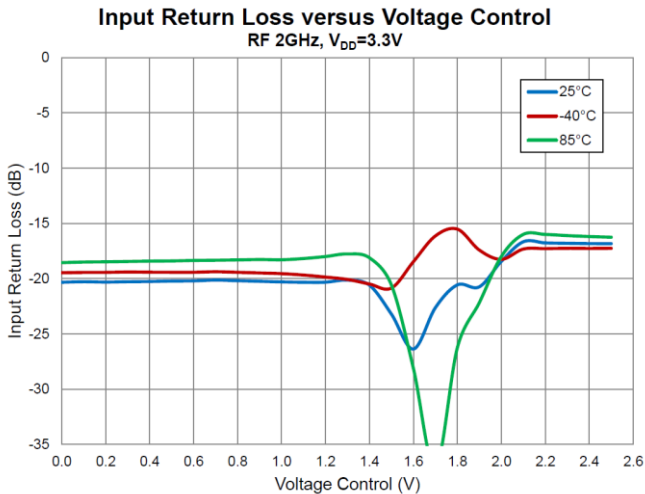
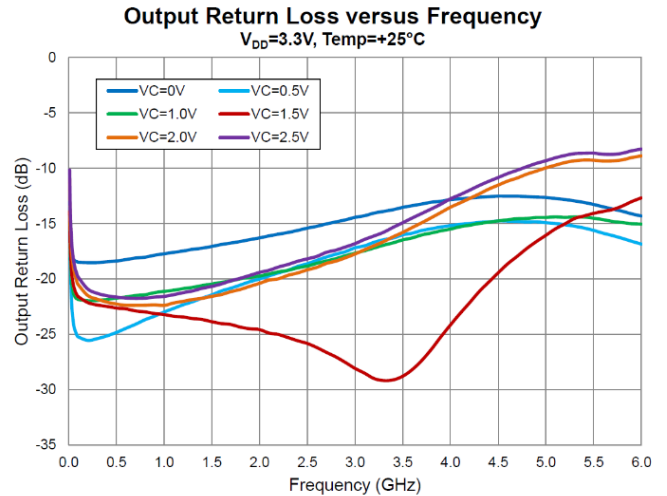
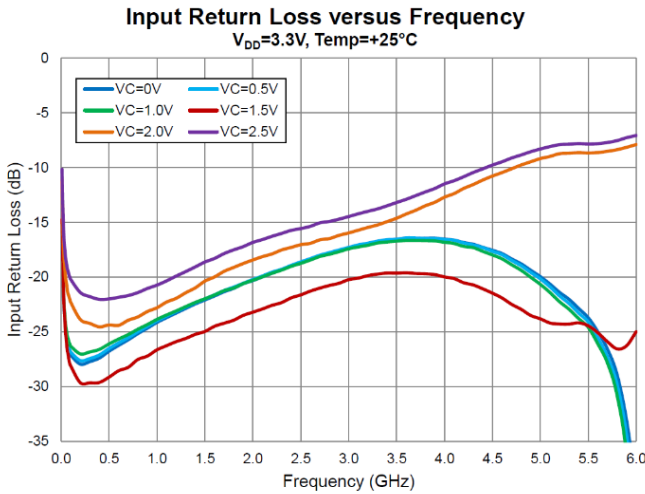
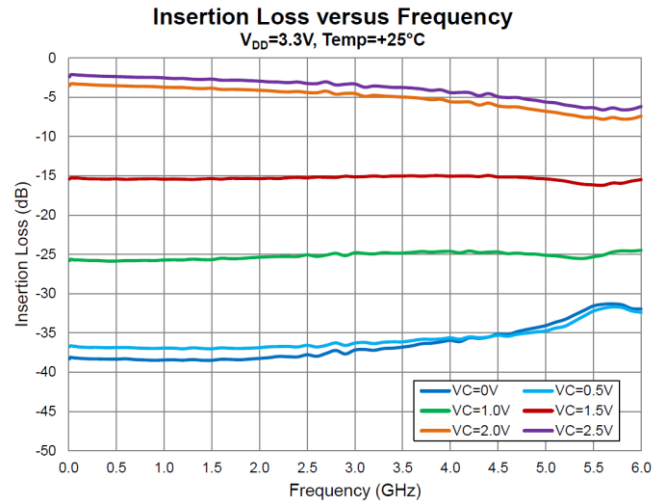
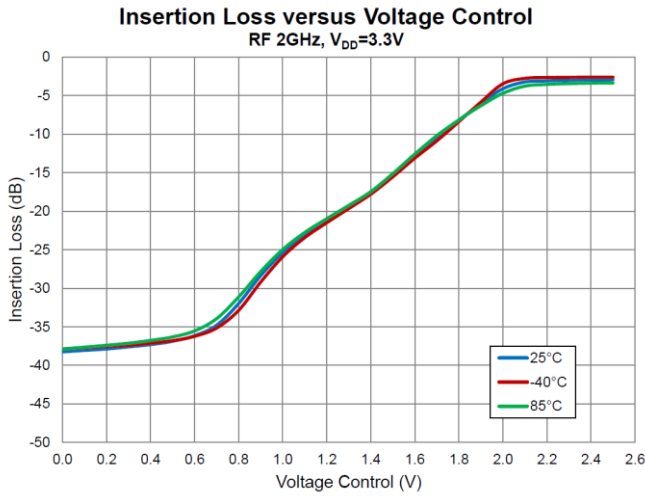

## Performance Plots – Positive S21 Slope

Test conditions unless otherwise noted:  $V_{DD} = +3.3V$ , Temp.=+25 °C, EVB trace and connector losses included

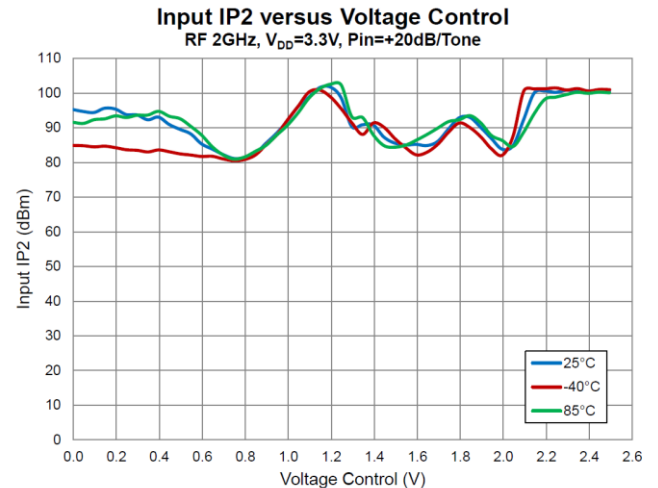
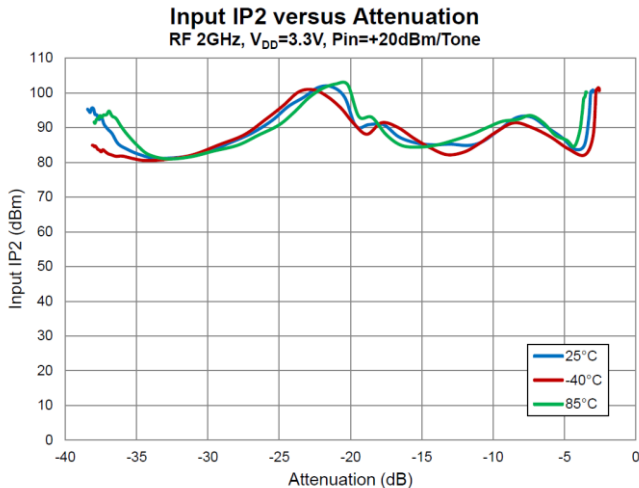
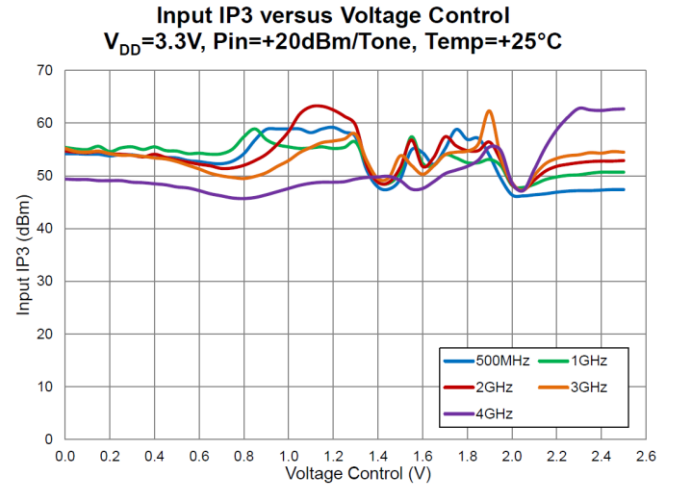
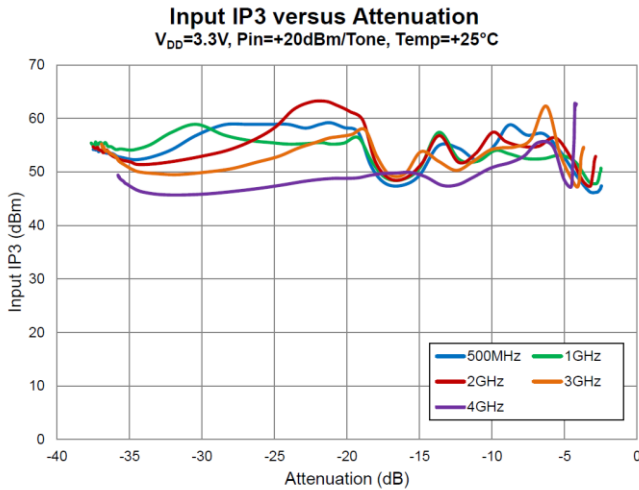
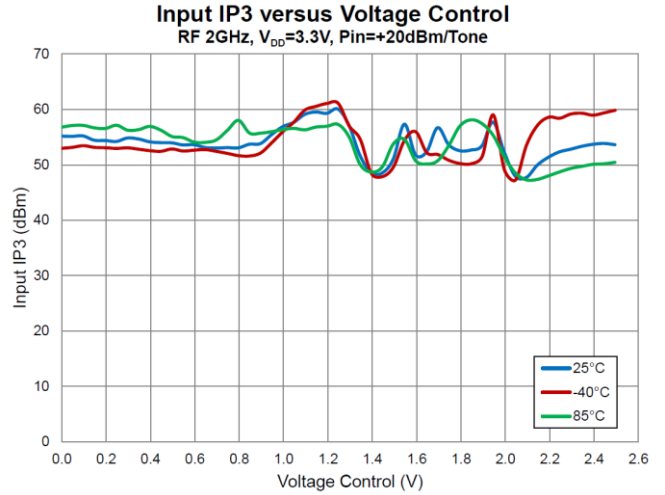
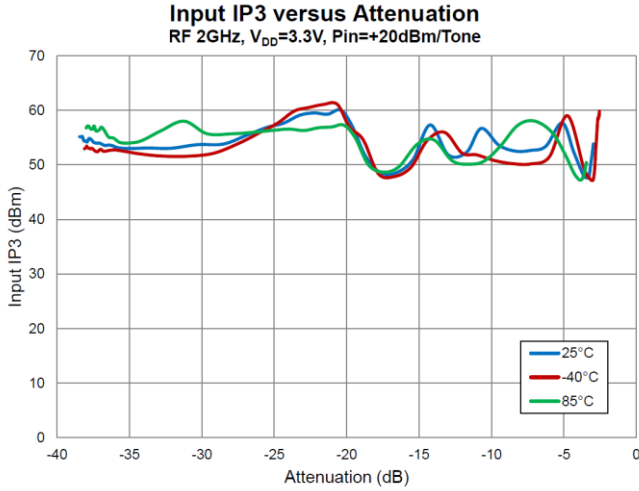

## Performance Plots – Positive S21 Slope

Test conditions unless otherwise noted:  $V_{DD} = +3.3V$ , Temp.=+25 °C, EVB trace and connector losses included

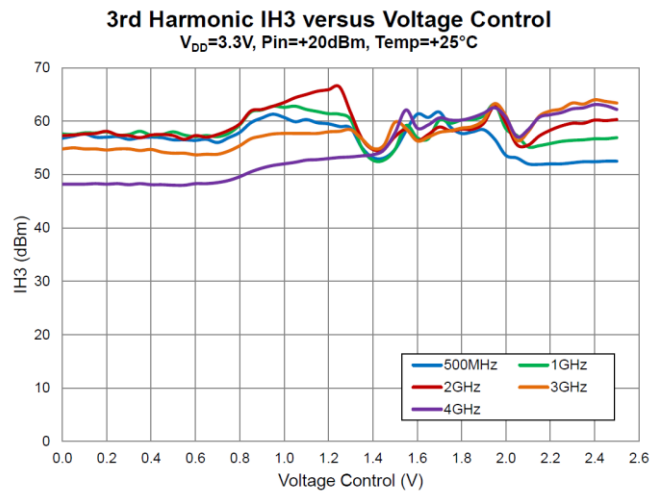
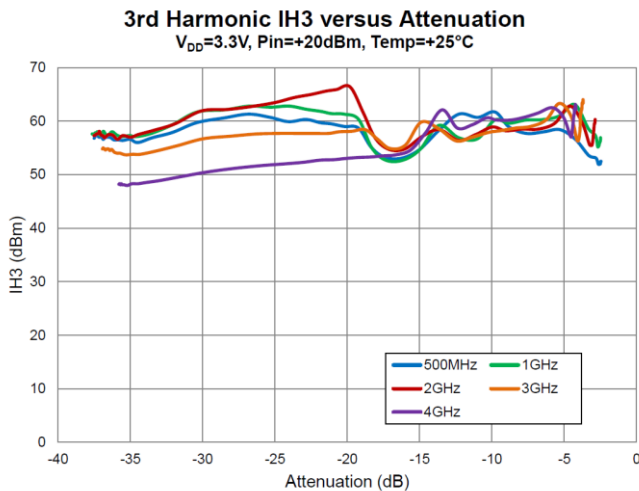
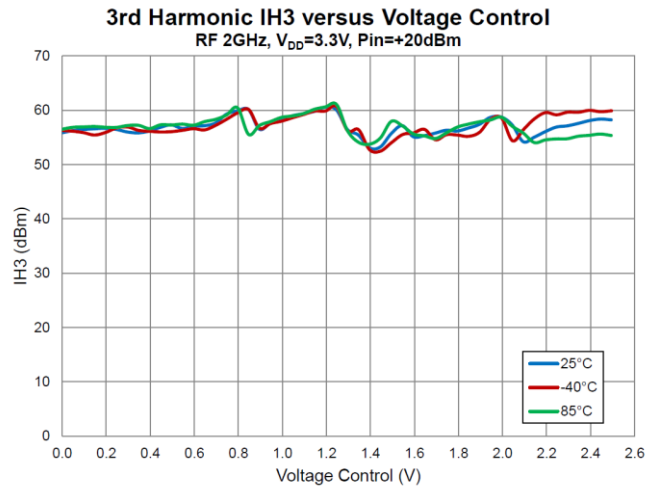
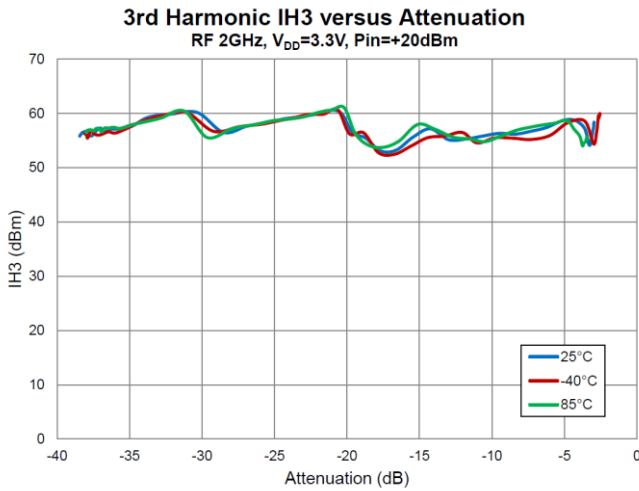
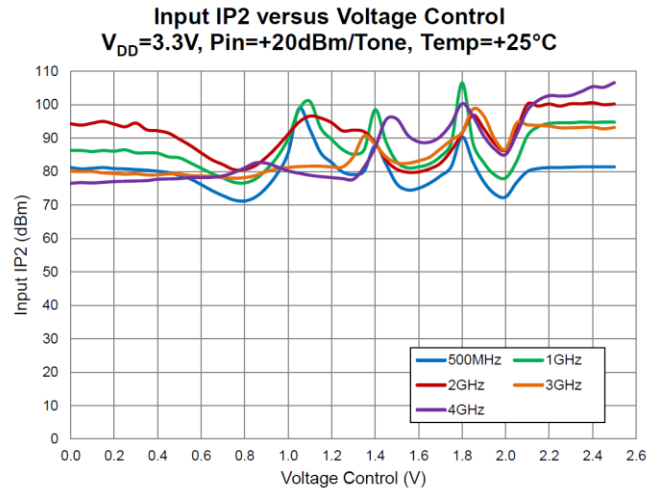
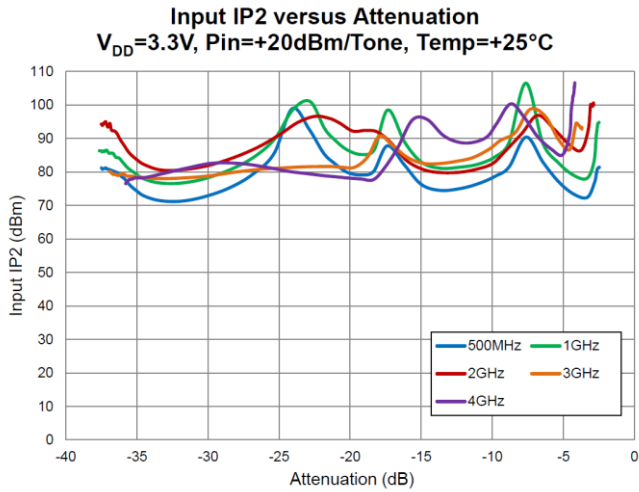

Performance Plots – Positive S21 Slope

Test conditions unless otherwise noted:  $V_{DD} = +3.3V$ , Temp.=+25 °C, EVB trace and connector losses included

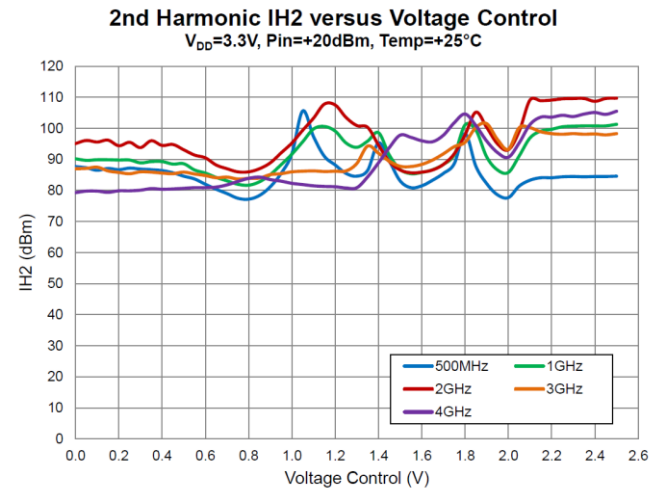
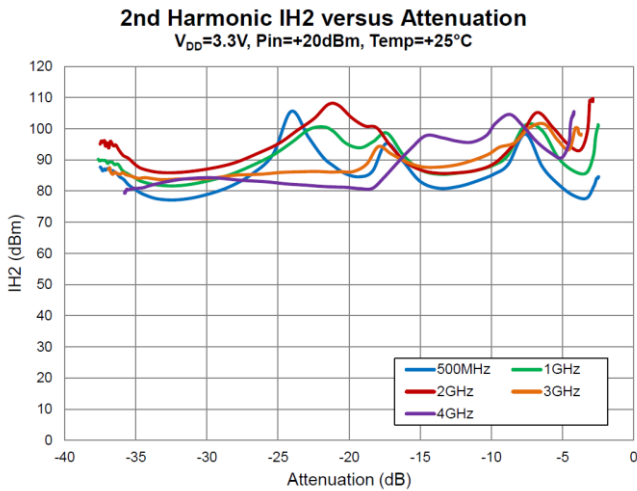
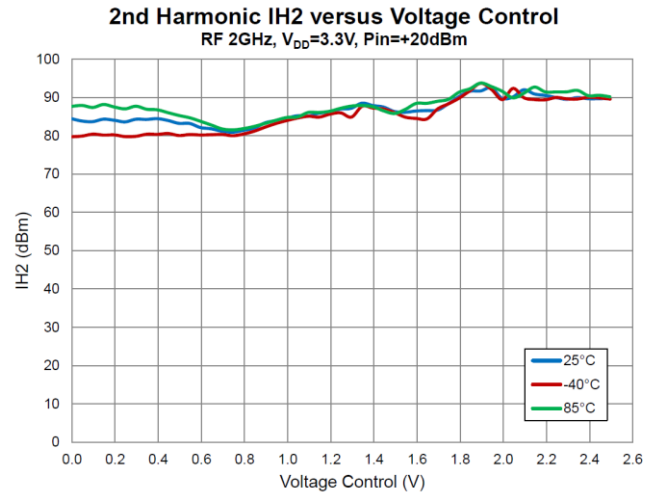
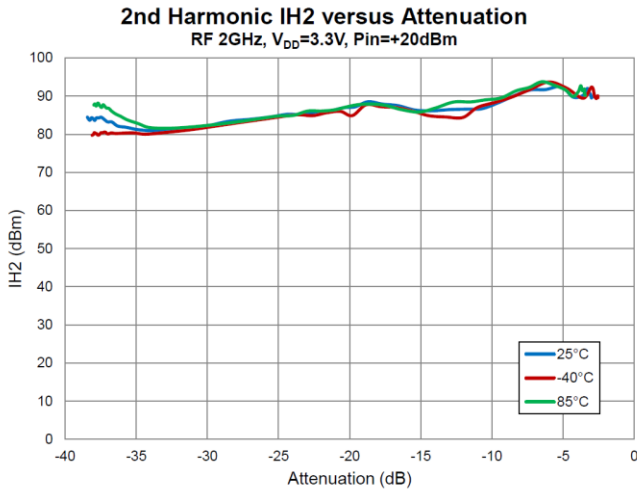



Performance Plots – Positive S21 Slope

Test conditions unless otherwise noted:  $V_{DD} = +3.3V$ , Temp.=+25 °C, EVB trace and connector losses included

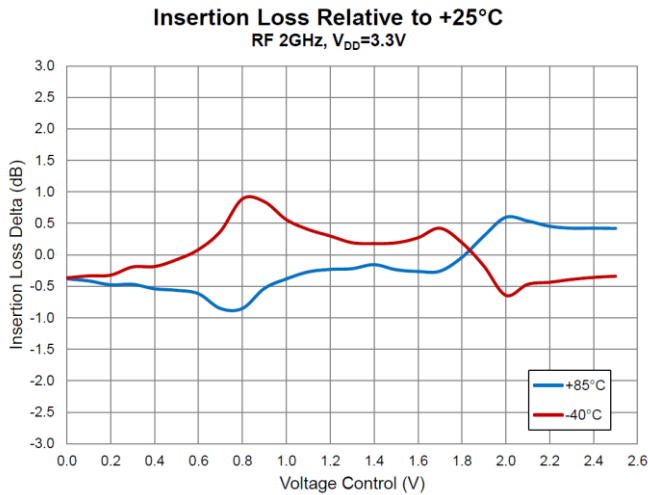
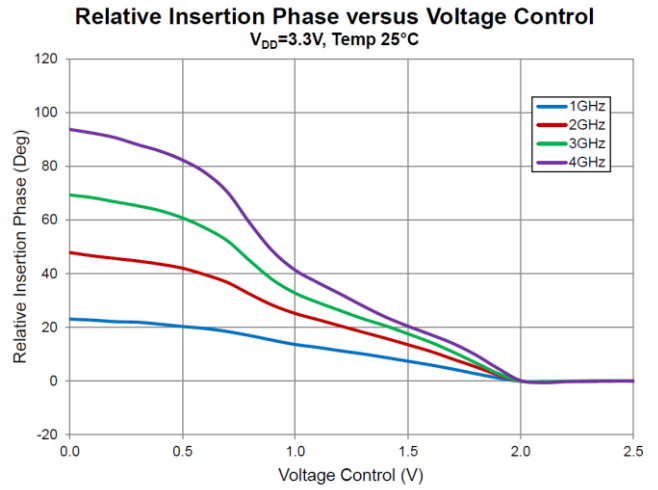
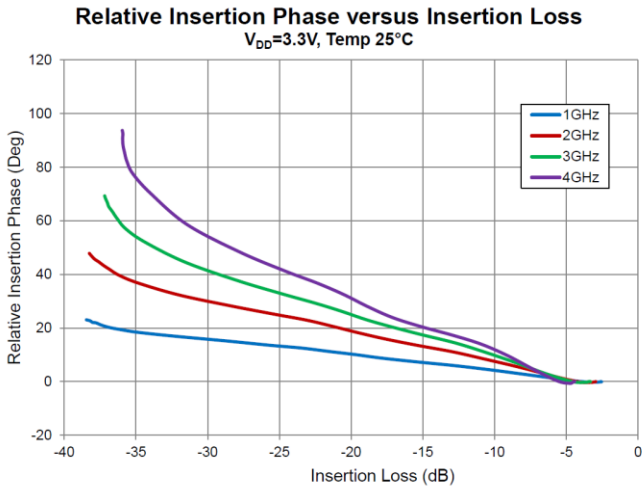



## Performance Plots – Negative S21 Slope

Test conditions unless otherwise noted:  $V_{DD} = +3.3\text{ V}$ , Temp.=+25 °C, EVB trace and connector losses included

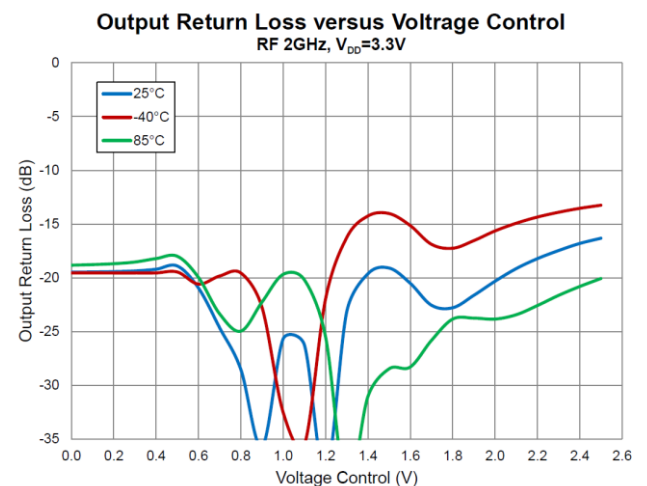
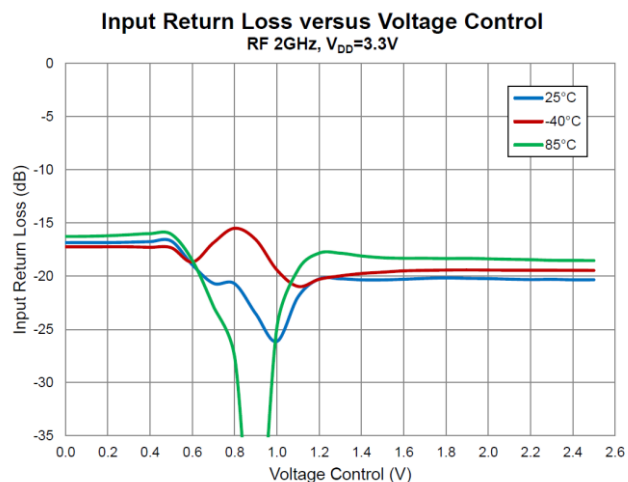
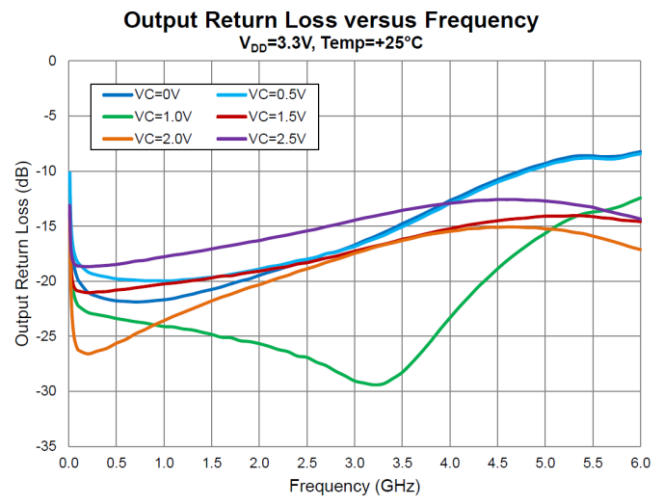
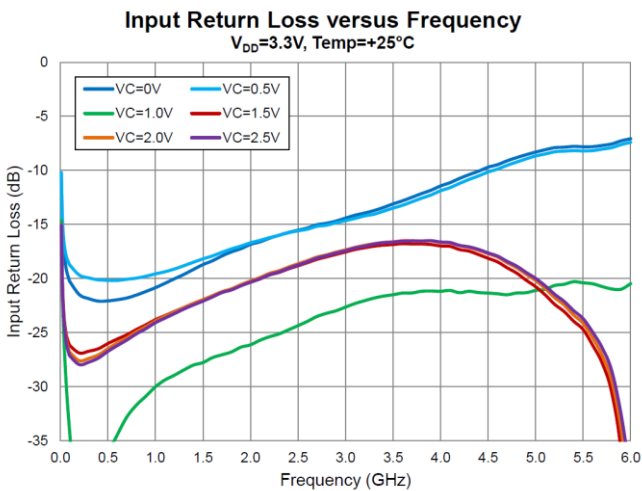
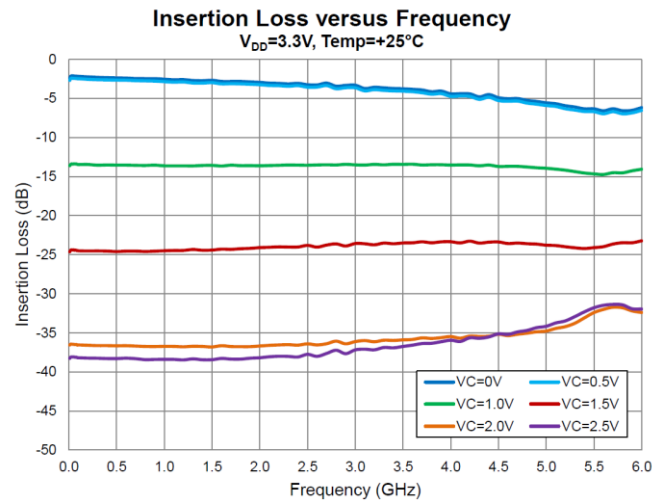
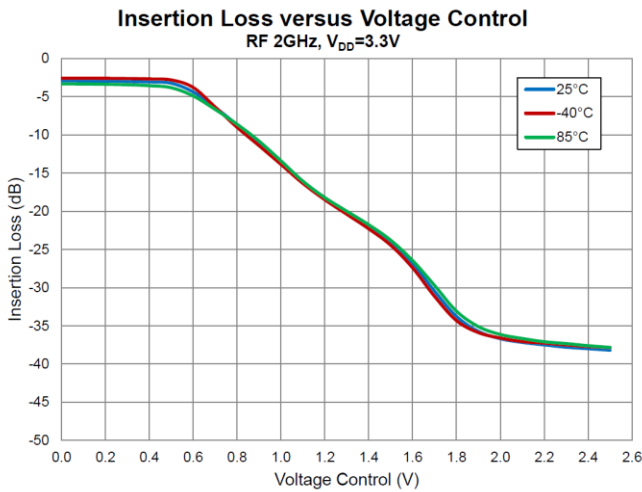

## Performance Plots – Negative S21 Slope

Test conditions unless otherwise noted:  $V_{DD} = +3.3V$ , Temp.=+25 °C, EVB trace and connector losses included

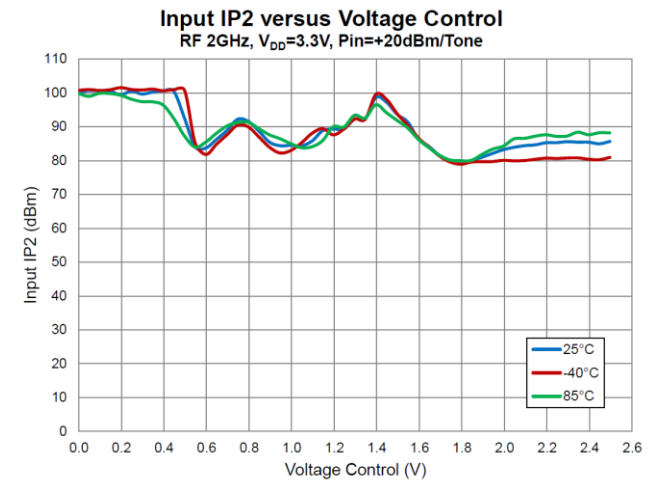
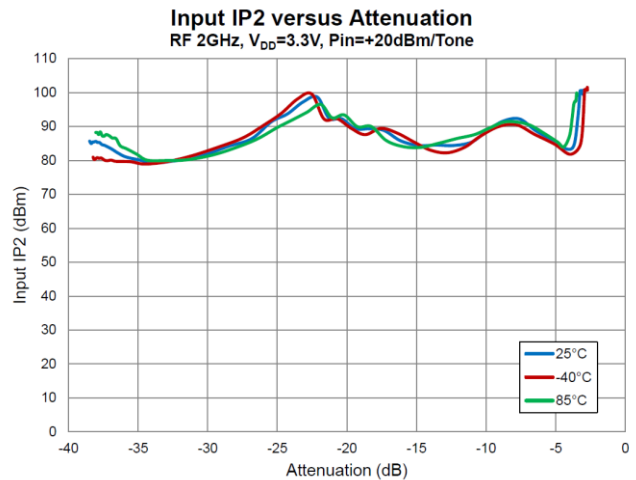
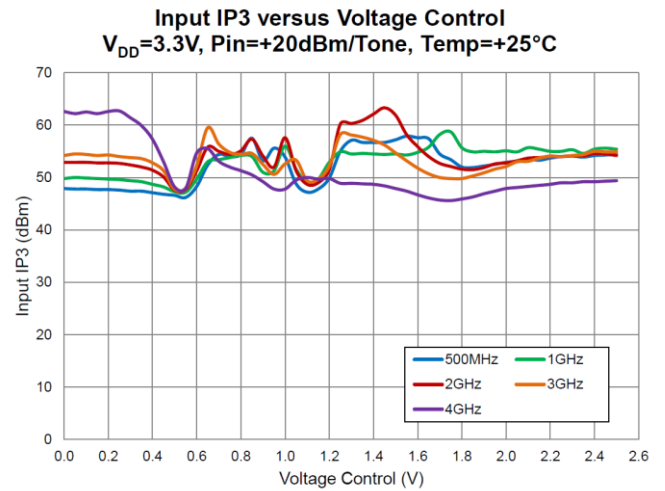
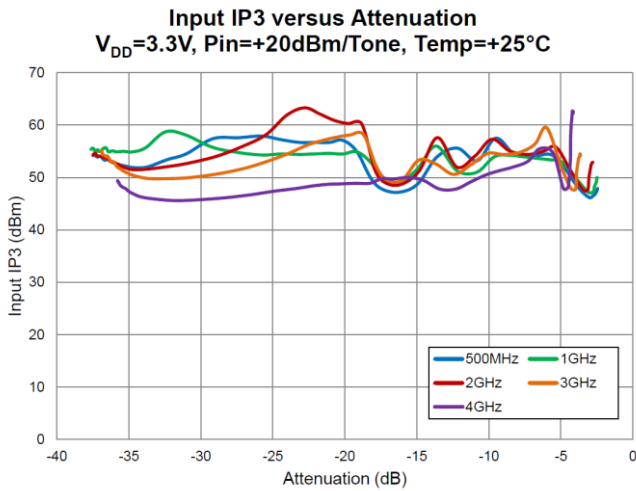
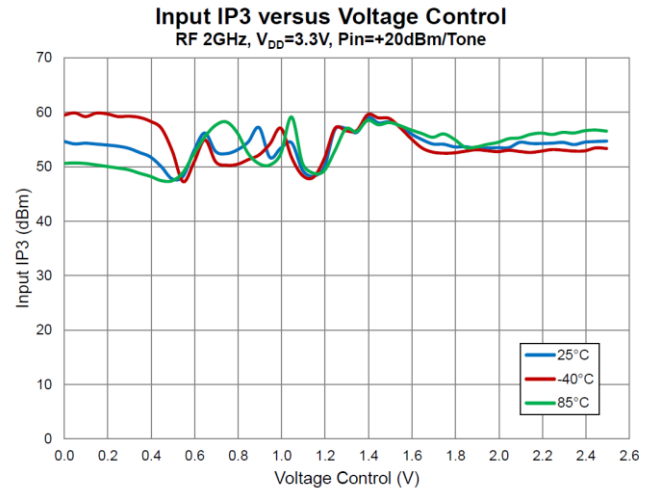
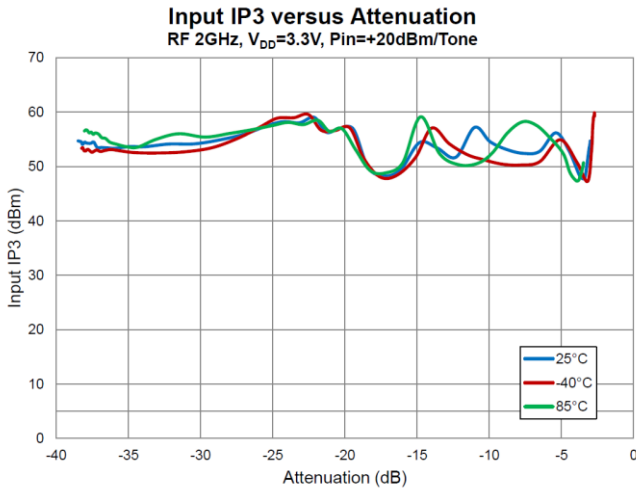

## Performance Plots – Negative S21 Slope

Test conditions unless otherwise noted:  $V_{DD} = +3.3V$ , Temp.=+25 °C, EVB trace and connector losses included

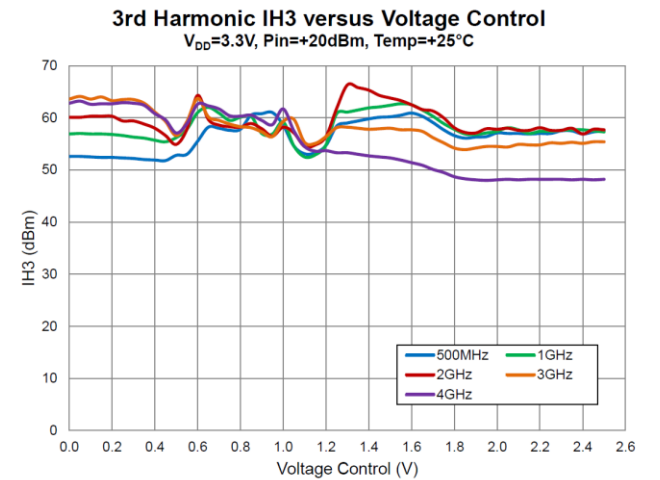
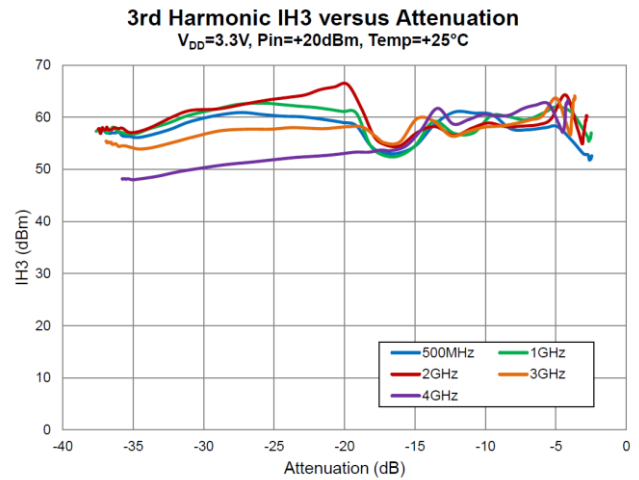
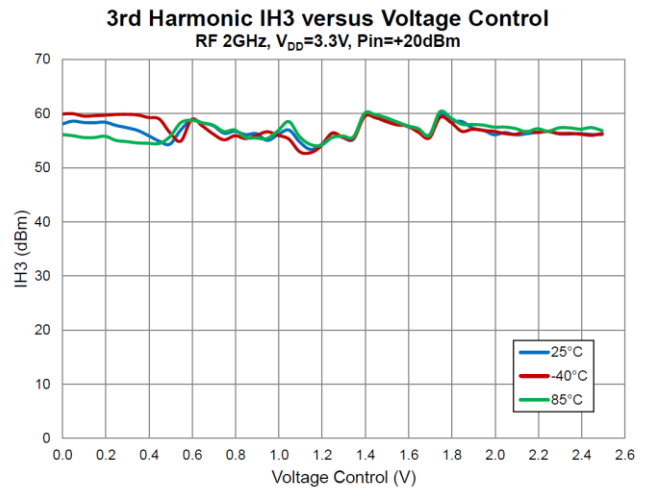
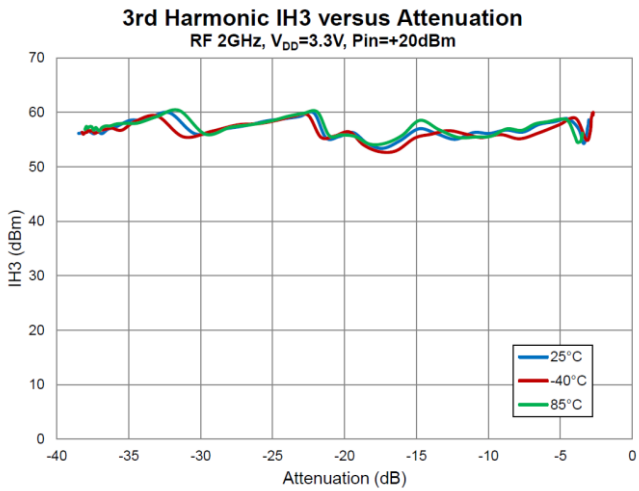
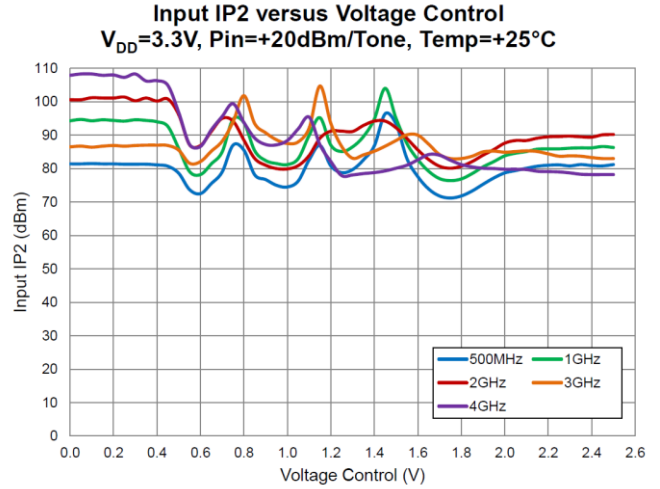
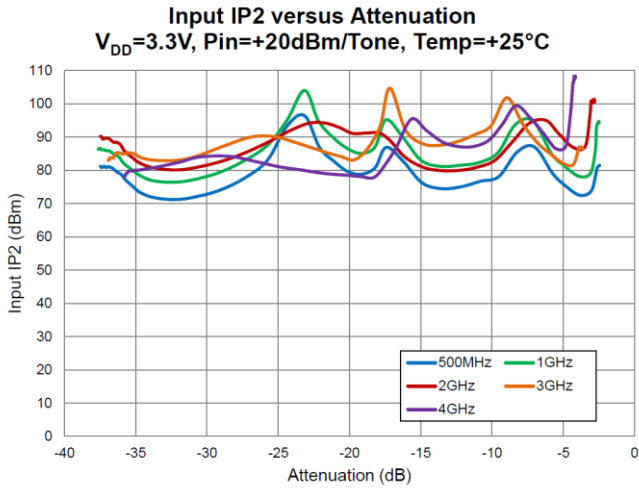

Performance Plots – Negative S21 Slope

Test conditions unless otherwise noted:  $V_{DD} = +3.3V$ , Temp.=+25 °C, EVB trace and connector losses included

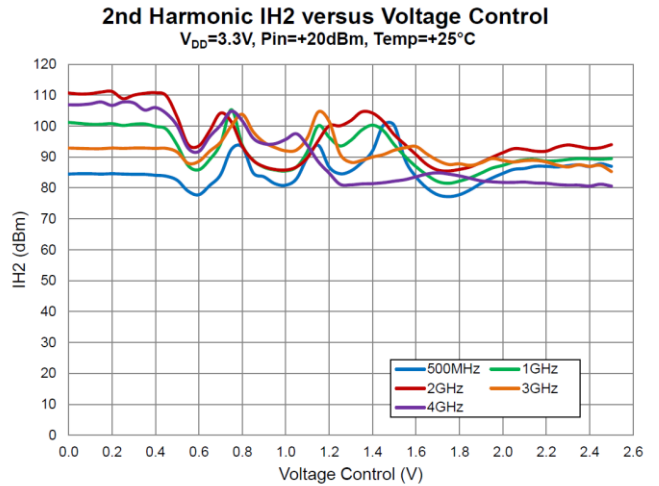
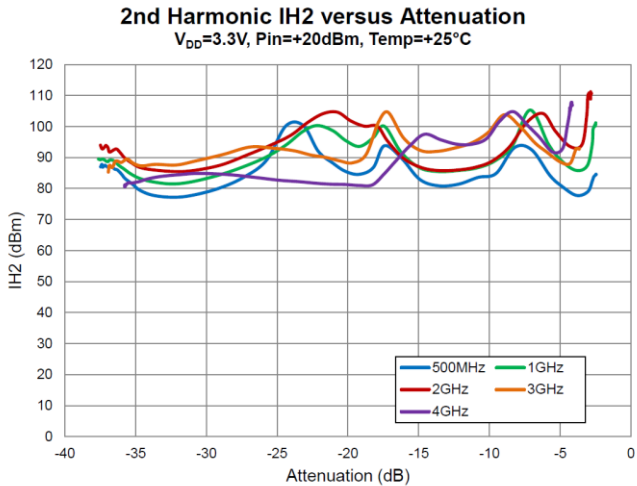
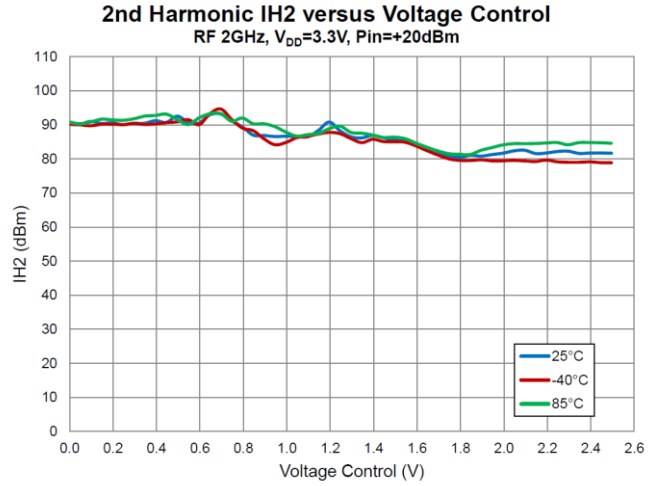
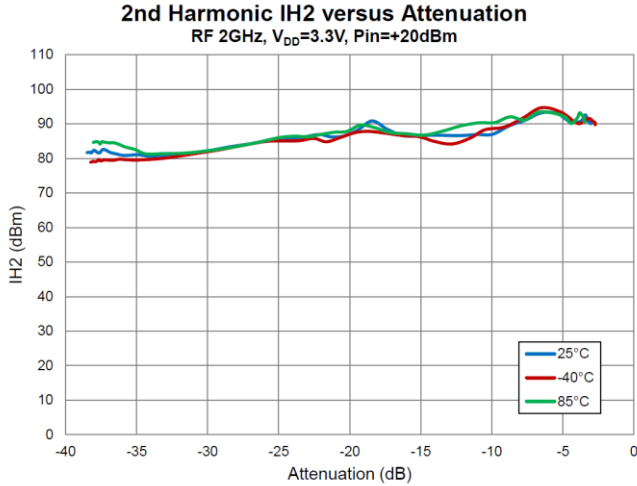

## Performance Plots – Negative S21 Slope

Test conditions unless otherwise noted:  $V_{DD} = +3.3V$ , Temp.=+25 °C, EVB trace and connector losses included

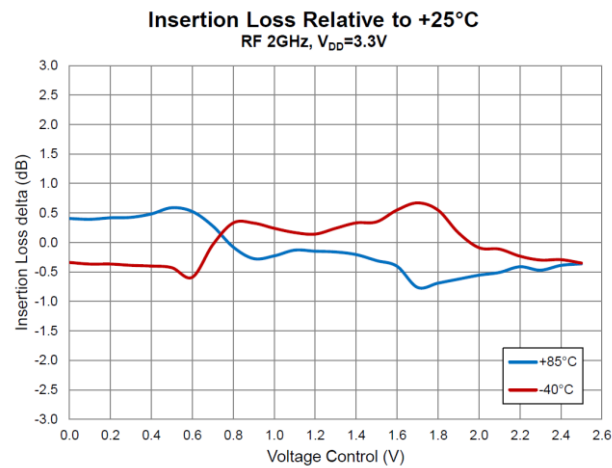
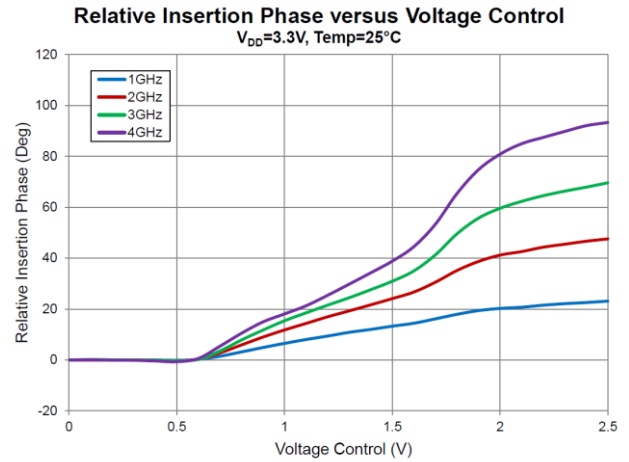
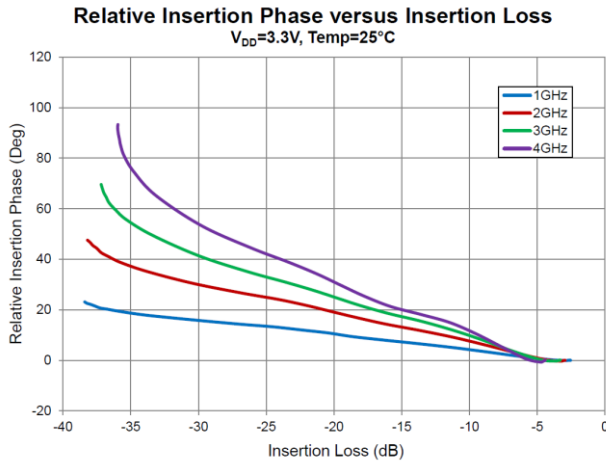

## Performance Plots – Voltage Control Pin Current

Test conditions unless otherwise noted:  $V_{DD} = +3.3V$ , Temp.=+25 °C, EVB trace and connector losses included

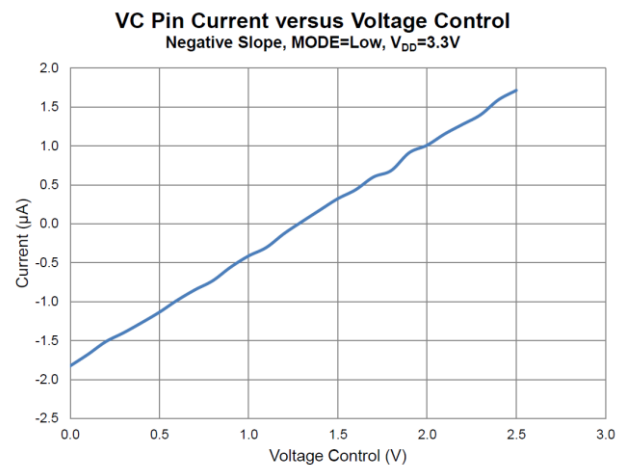
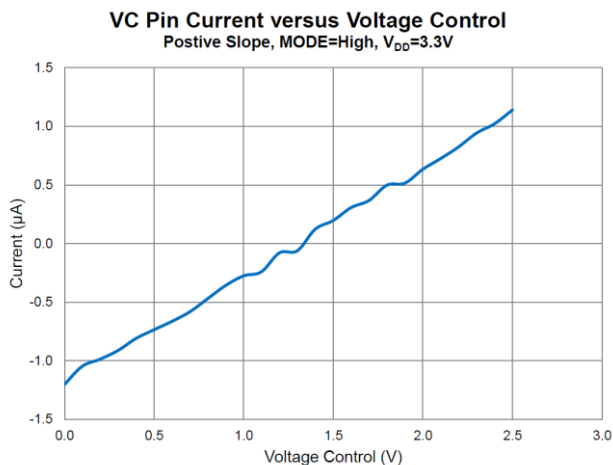

## Pad Configuration and Description

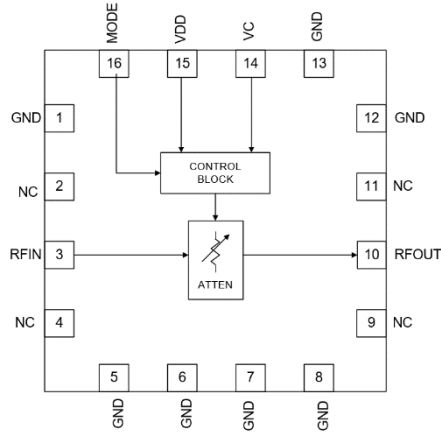

Top View

Pad No.	Label	Description
2, 4, 9, 11	NC	No Connection. Do not connect to PC board ground plane
3	RFIN	RF Input. External DC Block required. RF must input to this pin to ensure linearity and thermal performance
10	RFOUT	RF Output. External DC Block required. RF must output from this pin to ensure linearity and thermal performance
14	VC	Control Voltage Input for Attenuation adjustment
15	VDD	Device DC Voltage Supply Input
16	MODE	Attenuation Slope Selection: Logic Low Negative S21 slope; Logic High Positive S21 slope
1, 5, 6, 7, 8, 12, 13, Backside Paddle	GND	RF/DC ground. Use via holes to minimize inductance and thermal resistance. See PCB Mounting Pattern for suggested footprint.

## Package Marking and Dimensions

Marking: Part Number – SA  
2023  
Trace Code – Assigned by Sub-Contractor

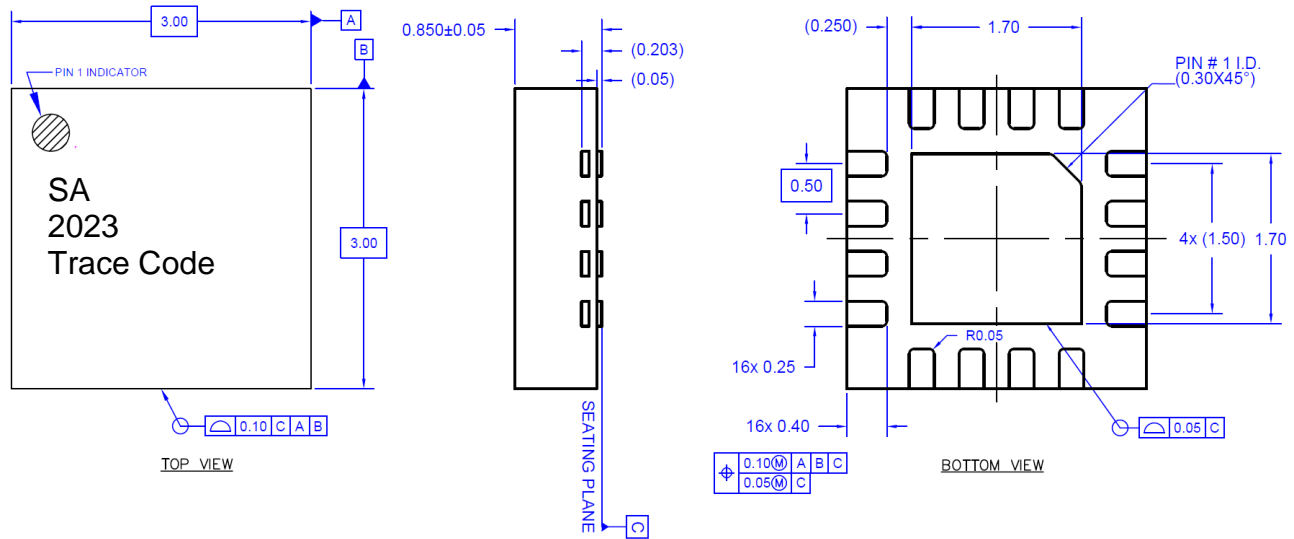

- Notes:
1. All dimensions are in millimeters. Angles are in degrees.
  2. The terminal #1 identifier and terminal numbering conform to JESD 95-1 SPP-012.
  3. Contact plating: Matte Tin

## PCB Mounting Pattern

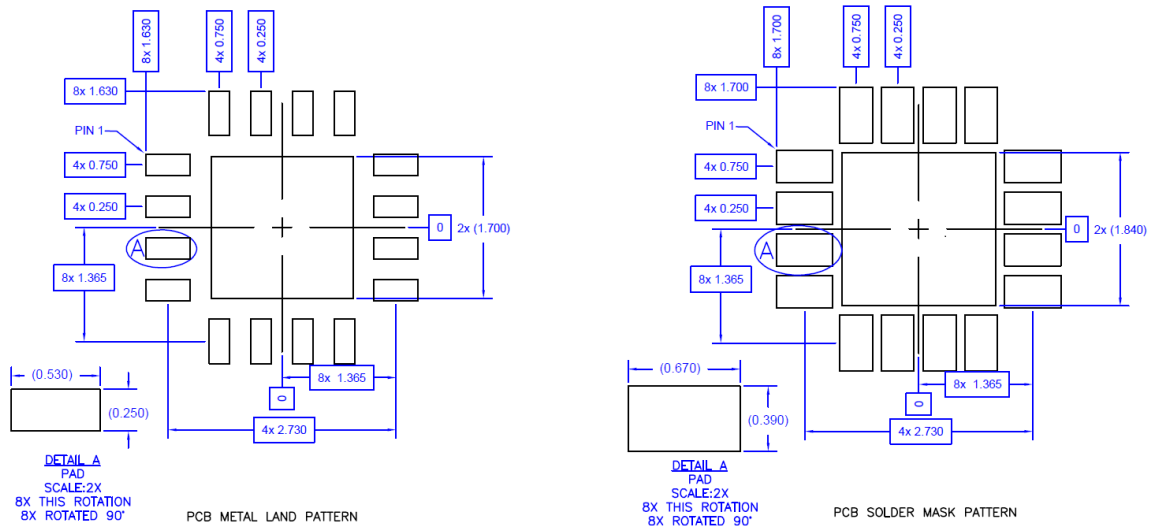

- Notes:
1. All dimensions are in millimeters. Angles are in degrees.
  2. Use 1 oz. copper minimum for top and bottom layer metal.
  3. Via holes are required under the backside paddle of this device for proper RF/DC grounding and thermal dissipation. We recommend a 0.35mm (#80/.0135") diameter bit for drilling via holes and a final plated thru diameter of 0.25 mm (0.01").
  4. Ensure good package backside paddle solder attach for reliable operation and best electrical performance.



## Handling Precautions

Parameter	Rating	Standard
ESD – Human Body Model (HBM)	Class 1C	ESDA / JEDEC JS-001-2012
ESD – Charged Device Model (CDM)	Class C5	JEDEC JESD22-C101F
MSL – Moisture Sensitivity Level	Level 1	IPC/JEDEC J-STD-020



Caution!  
ESD-Sensitive Device

## Solderability

Compatible with both lead-free (260°C max. reflow temp.) and tin/lead (245°C max. reflow temp.) soldering processes. Solder profiles available upon request.

Contact plating: Matte Tin

## RoHS Compliance

This part is compliant with 2011/65/EU RoHS directive (Restrictions on the Use of Certain Hazardous Substances in Electrical and Electronic Equipment) as amended by Directive 2015/863/EU.

This product also has the following attributes:

- Lead Free
- Halogen Free (Chlorine, Bromine)
- Antimony Free
- TBBP-A (C<sub>15</sub>H<sub>12</sub>Br<sub>4</sub>O<sub>2</sub>) Free
- PFOS Free
- SVHC Free



## Contact Information

For the latest specifications, additional product information, worldwide sales and distribution locations:

**Web:** [www.qorvo.com](http://www.qorvo.com)

**Tel:** 1-844-890-8163

**Email:** [customer.support@qorvo.com](mailto:customer.support@qorvo.com)

For technical questions and application information:

**Email:** [appsupport@qorvo.com](mailto:appsupport@qorvo.com)

## Important Notice

The information contained herein is believed to be reliable; however, Qorvo makes no warranties regarding the information contained herein and assumes no responsibility or liability whatsoever for the use of the information contained herein. All information contained herein is subject to change without notice. Customers should obtain and verify the latest relevant information before placing orders for Qorvo products. The information contained herein or any use of such information does not grant, explicitly or implicitly, to any party any patent rights, licenses, or any other intellectual property rights, whether with regard to such information itself or anything described by such information. **THIS INFORMATION DOES NOT CONSTITUTE A WARRANTY WITH RESPECT TO THE PRODUCTS DESCRIBED HEREIN, AND QORVO HEREBY DISCLAIMS ANY AND ALL WARRANTIES WITH RESPECT TO SUCH PRODUCTS WHETHER EXPRESS OR IMPLIED BY LAW, COURSE OF DEALING, COURSE OF PERFORMANCE, USAGE OF TRADE OR OTHERWISE, INCLUDING THE IMPLIED WARRANTIES OF MERCHANTABILITY AND FITNESS FOR A PARTICULAR PURPOSE.**

Without limiting the generality of the foregoing, Qorvo products are not warranted or authorized for use as critical components in medical, life-saving, or life-sustaining applications, or other applications where a failure would reasonably be expected to cause severe personal injury or death.

Copyright 2018 © Qorvo, Inc. | Qorvo is a registered trademark of Qorvo, Inc.

## X-ON Electronics

Largest Supplier of Electrical and Electronic Components

*Click to view similar products for [Attenuators](#) category:*

*Click to view products by [Qorvo](#) manufacturer:*

Other Similar products are found below :

[HMC305SLP4ETR](#) [MAAD-009195-000100](#) [TGL4201-00](#) [TGL4201-02](#) [TGL4201-03](#) [TGL4201-06](#) [TGL4201-10](#) [ATN3590-15](#) [20-50TPC](#)  
[D10AA5Z4](#) [18AH-01](#) [18AH-08](#) [ATN3580-20](#) [ATN3590-09](#) [20-50RP](#) [MASW-008322-000000](#) [MAATCC0009TR](#) [PCAF-10](#) [EXB-](#)  
[24AT9AR5X](#) [ATN3580-06](#) [ATN3580-10](#) [HMC539ALP3ETR](#) [ATN3580-02](#) [ATN3590-07](#) [SKY12408-321LF](#) [ATN3580-03](#)  
[WA04P005XBTL](#) [HMC-VVD104-SX](#) [WA04P007XCTL](#) [SKY12236-11](#) [MAATSS0018TR-3000](#) [HMC656-SX](#) [WA04P001XBTL](#) [MAAV-](#)  
[007941-TR3000](#) [WA04P004XBTL](#) [WA04P002XBTL](#) [C3A50Z4](#) [HMC941A](#) [PAT0816-C-0DB-T5](#) [PAT0816-C-8DB-T5](#) [PAT1632-C-3DB-](#)  
[T1](#) [PAT1632-C-6DB-T1](#) [PAT1632-C-10DB-T1](#) [PAT1632-C-1DB-T1](#) [PAT0816-C-2DB-T5](#) [PAT0816-C-4DB-T5](#) [DHM510-0100-006](#)  
[CMD172](#) [MAT10300](#) [MAT10180](#)