

Functional Block Diagram

Features

- Patented Circuit Architecture
- Broadband 50MHz to 6000MHz Frequency Range
- Low Minimum Insertion Loss (1.0dB Typical at 2GHz)
- 25dB Attenuation Range
- +40dBm IIP3 Typical
- +75dBm IIP2 Typical
- High 1dB Compression Point >+24dBm
- Low Supply Current 2.5mA Typical
- 3V to 5V Power Supply
- Linear in dB Control Characteristic
- Internal Temperature Compensation
- Low Distortion with -65dBc CSO, CTB and XMOD
- Class 2 ESD (2000V HBM)
- Complete Solution in a Small 3mm x 3mm, QFN Package

Applications

- Cellular, 3G Infrastructure
- WiBro, WiMax, LTE
- Microwave Radio
- High-linearity Power Control
- Cable Modems
- CATV

Product Description

RFMD's RFSA2033 is a fully monolithic analog voltage controlled attenuator (VCA) featuring exceptional linearity over a typical temperature-compensated 25dB gain control range and low insertion loss of 1.0dB typical. It incorporates a revolutionary new circuit architecture to solve a long standing industry problem: high IP3, high attenuation range, low DC current, broad bandwidth, and temperature-compensated linear in dB control voltage characteristic. This voltage controlled attenuator is controlled by a single positive control voltage with on chip DC conditioning circuitry. The slope polarity of the control voltage versus gain is selectable. The RFSA2033 draws a very low 2.5mA current. This attenuator is matched to 50Ω over its rated control range and frequency with no external matching components require. Typical VCA's in this performance category have poor inherent attenuation versus temperature and poor nonlinear attenuation versus control voltage characteristics. To correct these shortcomings, other VCA's require extensive off chip analog support circuitry that consume valuable PCB area and additional DC power. This game changing product incorporates the complete solution in a small 3mm x 3mm QFN package that reduces the footprint in area and reduces the DC power over conventional PIN diode approaches.

Ordering Information

RFSA2033SQ	Sample bag with 25 pieces
RFSA2033SR	7" Reel with 100 pieces
RFSA2033TR7	7" Reel with 2500 pieces
RFSA2033PCK-410	50MHz to 6000MHz PCBA with 5-piece sample bag
RFSA2033PCK-411	CATV, 75Ω PCBA with 5-piece sample bag

Absolute Maximum Ratings

Parameter	Rating	Unit
Supply Voltage (V _{DD})	-0.5 to +6	V
SLOPE, VC, EN Pins	-0.5 to +6	V
RF input Power	+27	dBm
Operating Temperature (T _{CASE})	-40 to +85	°C
Storage Temperature	-65 to +150	°C
Junction Temperature	+125	°C
ESD Rating (HBM)	2000	V



Caution! ESD sensitive device.

Exceeding any one or a combination of the Absolute Maximum Rating conditions may cause permanent damage to the device. Extended application of Absolute Maximum Rating conditions to the device may reduce device reliability. Specified typical performance or functional operation of the device under Absolute Maximum Rating conditions is not implied.

The information in this publication is believed to be accurate and reliable. However, no responsibility is assumed by RF Micro Devices, Inc. ("RFMD") for its use, nor for any infringement of patents, or other rights of third parties, resulting from its use. No license is granted by implication or otherwise under any patent or patent rights of RFMD. RFMD reserves the right to change component circuitry, recommended application circuitry and specifications at any time without prior notice.



RFMD Green: RoHS compliant per EU Directive 2002/95/EC, halogen free per IEC 61249-2-21, <1000ppm each of antimony trioxide in polymeric materials and red phosphorus as a flame retardant, and <2% antimony in solder.

Nominal Operating Parameters

Parameter	Specification			Unit	Condition
	Min.	Typ.	Max.		
General					
					50Ω Application Circuit
Supply Voltage	3	5	5.5	V	Internal voltage regulator
Supply Current		2.5	3.5	mA	
Operating Temperature	-40		85	°C	
Thermal Resistance		101		°C/W	
RF Input Power			24	dBm	
RF Performance					
					50Ω Application Circuit
Frequency Range	50		6000	MHz	
Minimum Insertion Loss		1		dB	
Gain Control Range		25		dB	
Gain versus Temperature		1		dB	Peak to peak gain variation over temperature for fixed control range
Return Loss		15		dB	
Relative Phase		7		Deg	Insertion phase at 15dB attenuation relative to minimum insertion loss
Input 1dB Compression Point		24		dBm	
Input IP3		40		dBm	P _{IN} + (IM3 _{dBc} /2)
Input IP2		75		dBm	P _{IN} + IM2 _{dBc} , IM2 is F1 + F2
Input IH2		80		dBm	P _{IN} + H2 _{dBc} , H2 is second harmonic
Input IH3		45		dBm	P _{IN} + (H3 _{dBc} /2), H3 is third harmonic
Composite Performance (CATV)					
					75Ω Application Circuit
CSO		-65		dBc	112 Channels, Flat tilt, 32dBmV/Channel
CTB		-65		dBc	
XMOD		-65		dBc	

Control					
Voltage Control Range, Positive Attenuation Slope	0		2.5	V	2.5V control voltage is lowest insertion loss, SLOPE pin logic high
Voltage Control Range, Negative Attenuation Slope	0		2.5	V	0V control voltage is lowest insertion loss, SLOPE pin logic low
Voltage Control Pin Current		1.2		μA	VC Pin at 2.5V
SLOPE and EN Pins Logic Low			0.4	V	
SLOPE and EN Pins Logic High	1			V	
Settling Time		1.5		μs	2dB attenuation change settling within 0.1dB of final value

Note: Typical performance at nominal conditions unless otherwise noted: Supply voltage = 3.0V, Operating temperature = 25°C, RF Frequency 2GHz, second RF frequency 2.001GHz for two tone measurements.

Measured Positive Attenuation Slope Performance

Note: 50Ω Application Circuit – Data includes PCB and connector losses

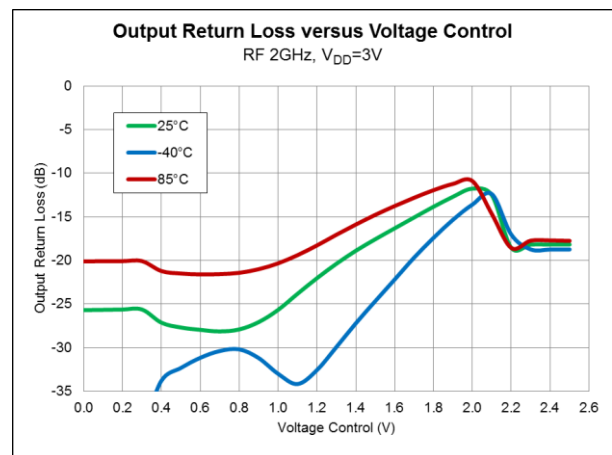
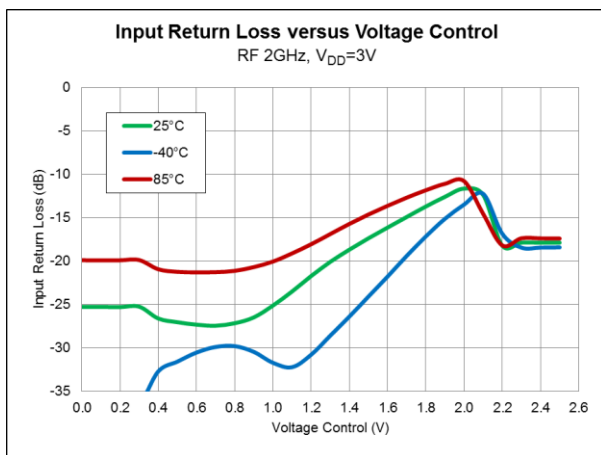
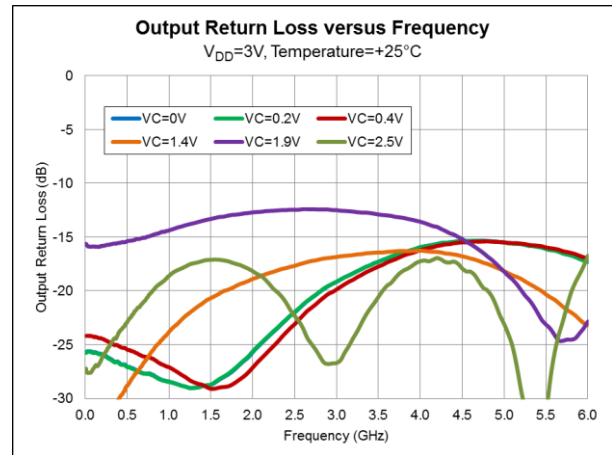
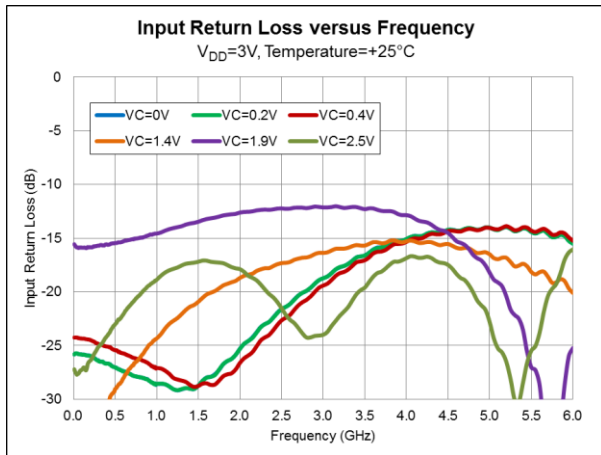
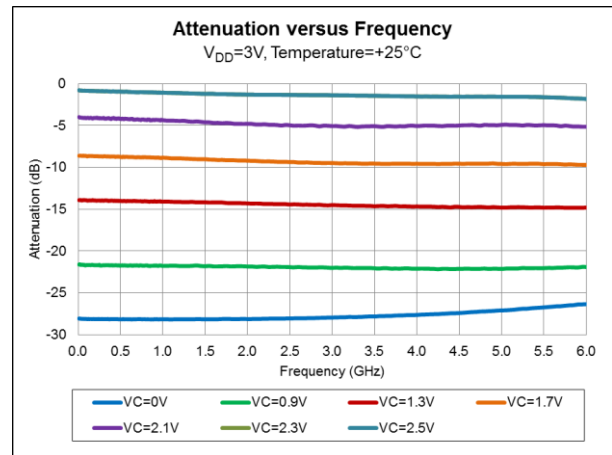
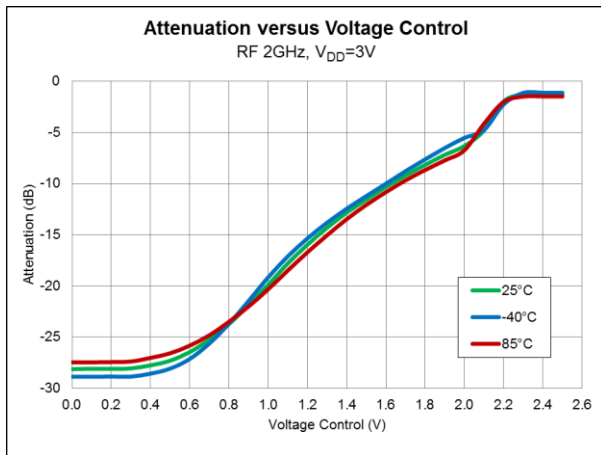

RF MICRO DEVICES®, RFMD®, Optimum Technology Matching®, Enabling Wireless Connectivity™, PowerStar®, POLARIS™ TOTAL RADIO™ and UltimateBlue™ are trademarks of RFMD, LLC. BLUETOOTH is a trademark owned by Bluetooth SIG, Inc. U.S.A. and licensed for use by RFMD. All other trade names, trademarks and registered trademarks are the property of their respective owners. ©2009, RF Micro Devices, Inc.

Measured Positive Attenuation Slope Performance

Note: 50Ω Application Circuit – Data includes PCB and connector losses

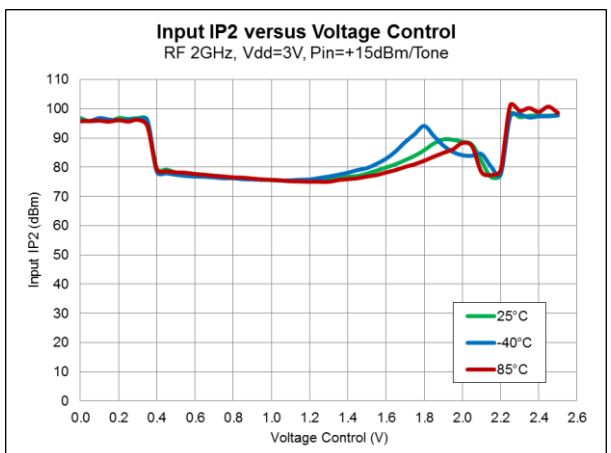
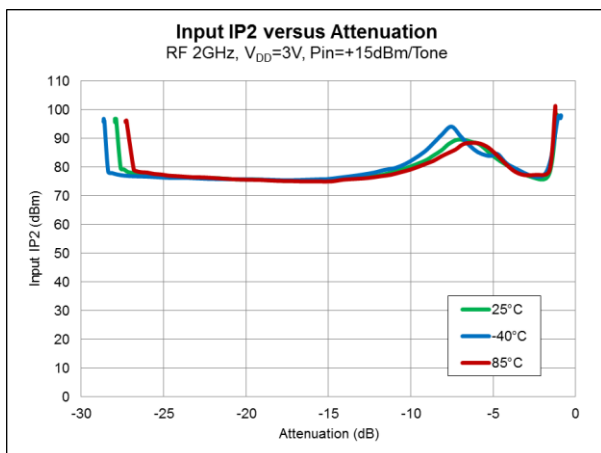
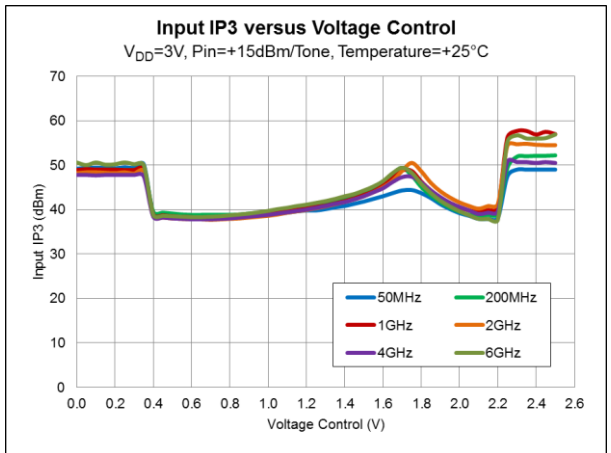
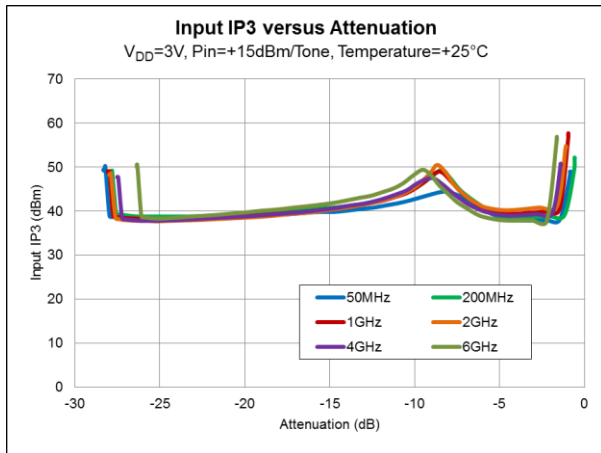
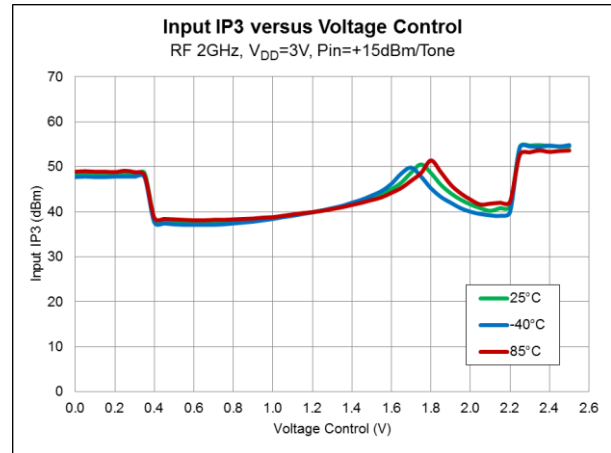
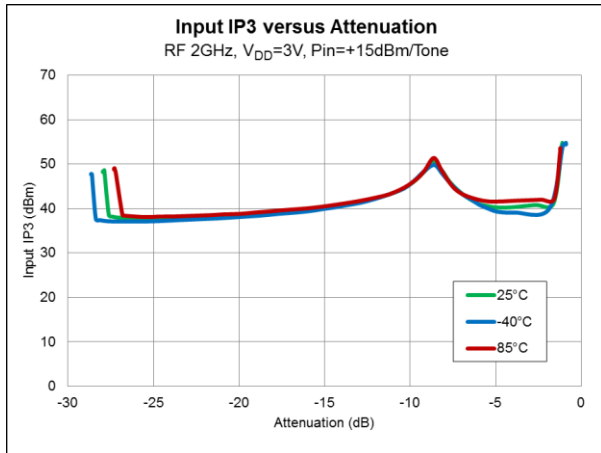

RF MICRO DEVICES®, RFMD®, Optimum Technology Matching®, Enabling Wireless Connectivity™, PowerStar®, POLARIS™ TOTAL RADIO™ and UltimateBlue™ are trademarks of RFMD, LLC. BLUETOOTH is a trademark owned by Bluetooth SIG, Inc., U.S.A. and licensed for use by RFMD. All other trade names, trademarks and registered trademarks are the property of their respective owners. ©2009, RF Micro Devices, Inc.

Measured Positive Attenuation Slope Performance

Note: 50Ω Application Circuit – Data includes PCB and connector losses

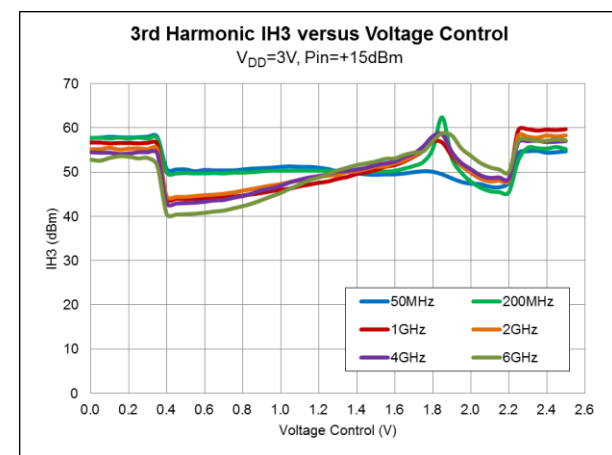
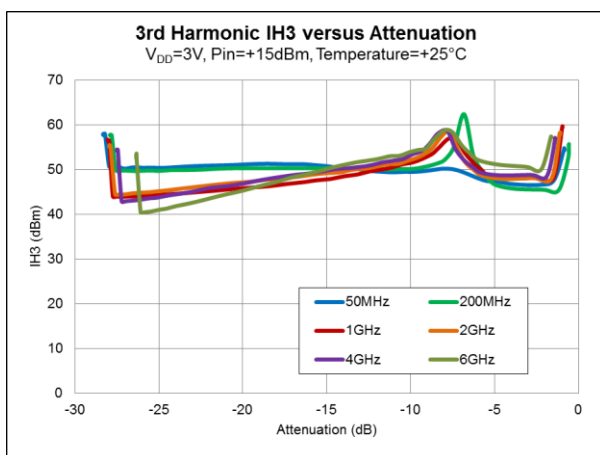
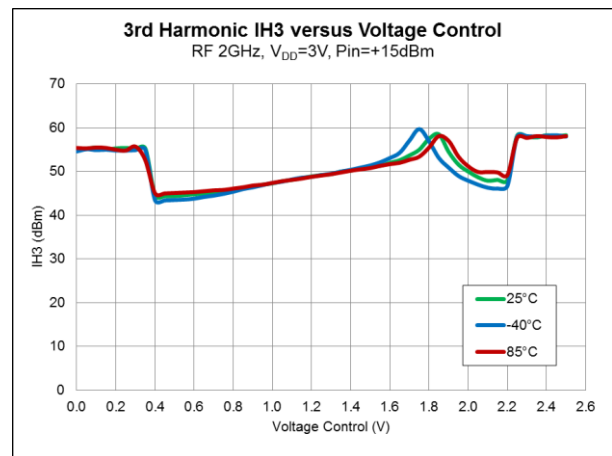
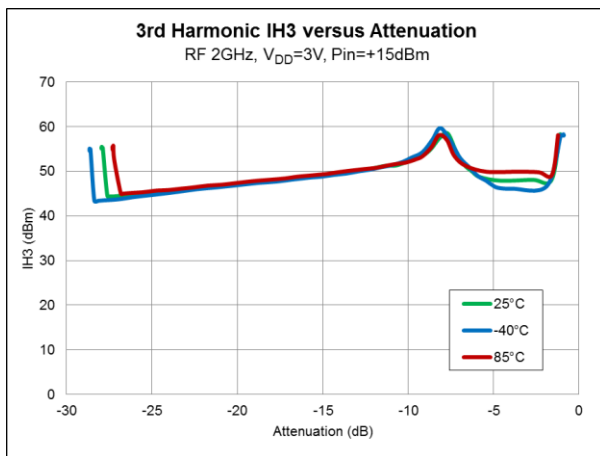
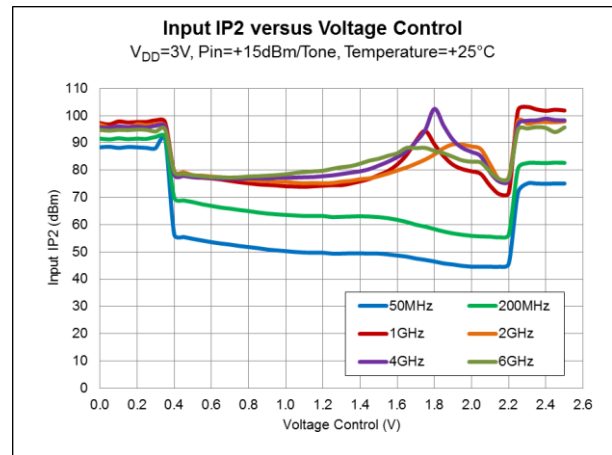
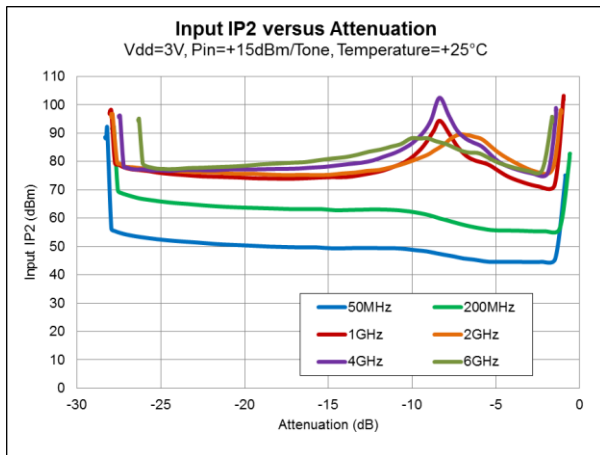

Measured Positive Attenuation Slope Performance

Note: 50Ω Application Circuit – Data includes PCB and connector losses

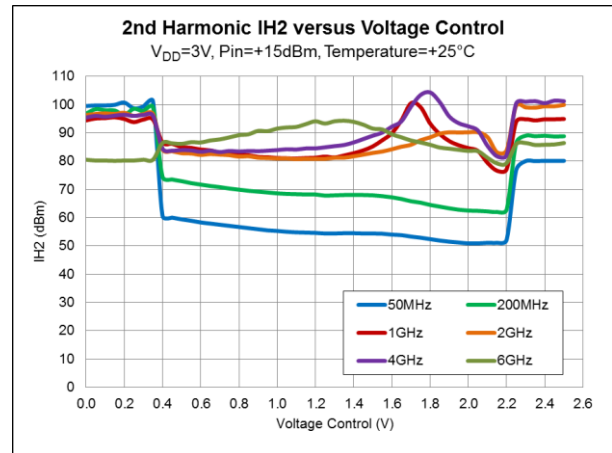
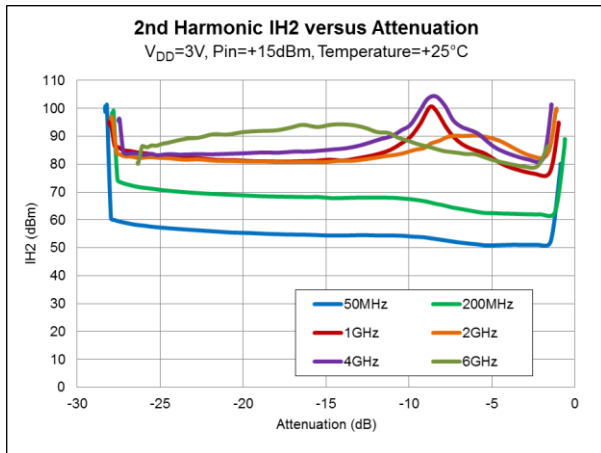
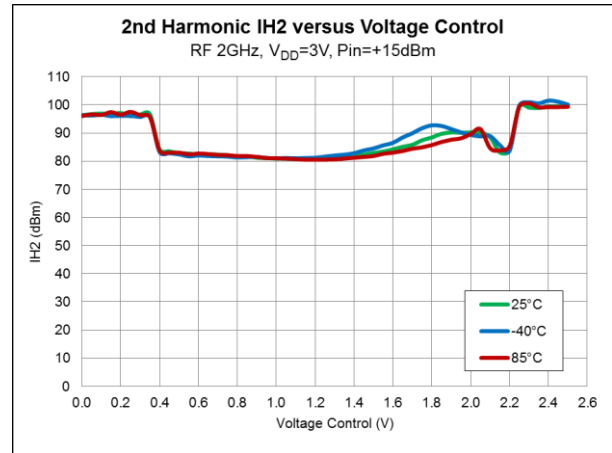
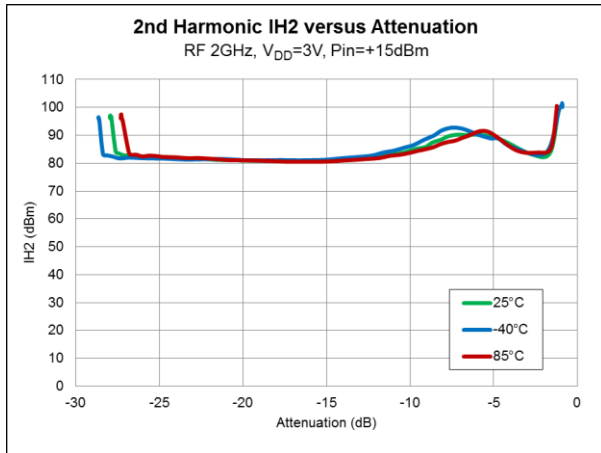

Measured Positive Attenuation Slope Performance

Note: 50Ω Application Circuit – Data includes PCB and connector losses

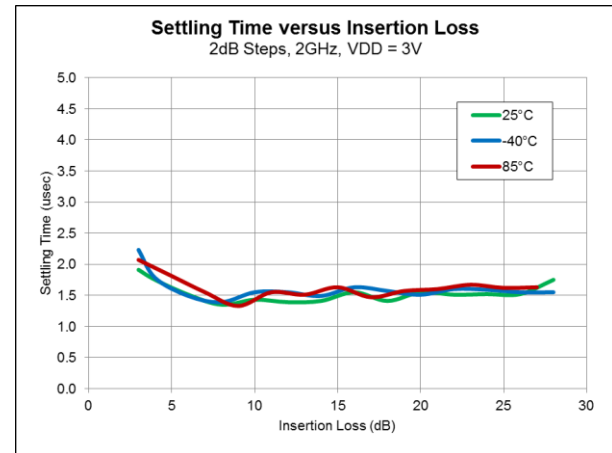
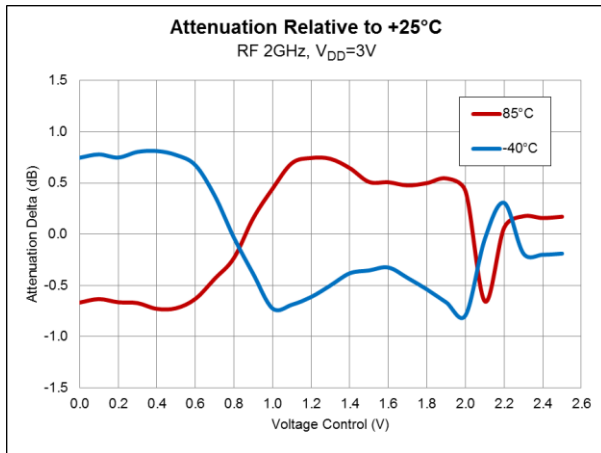
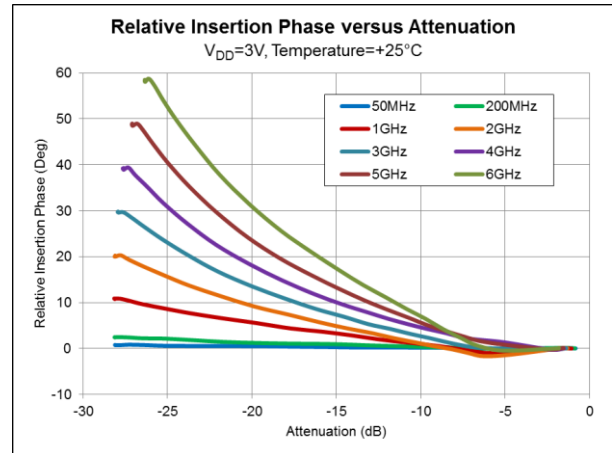
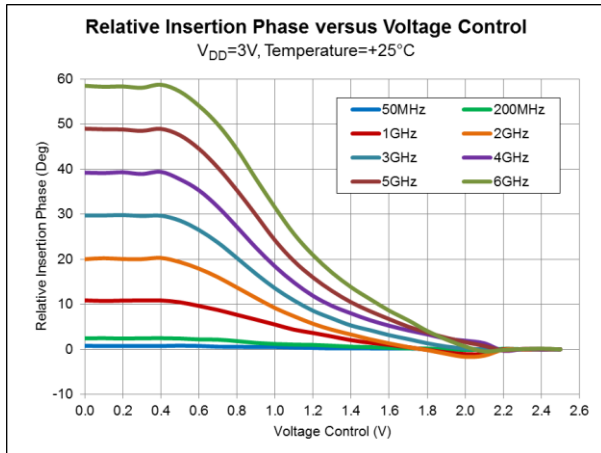

Measured Negative Attenuation Slope Performance

Note: 50Ω Application Circuit – Data includes PCB and connector losses

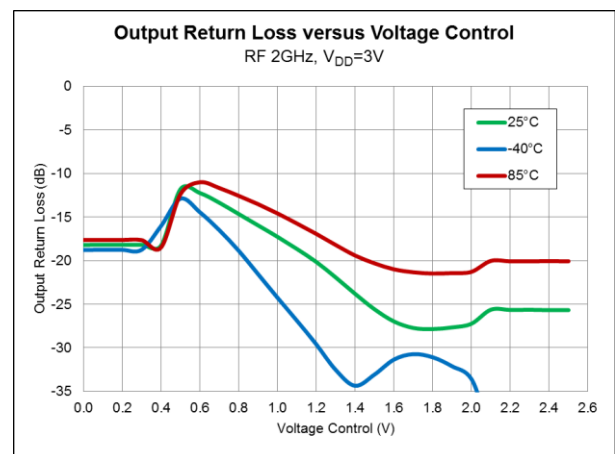
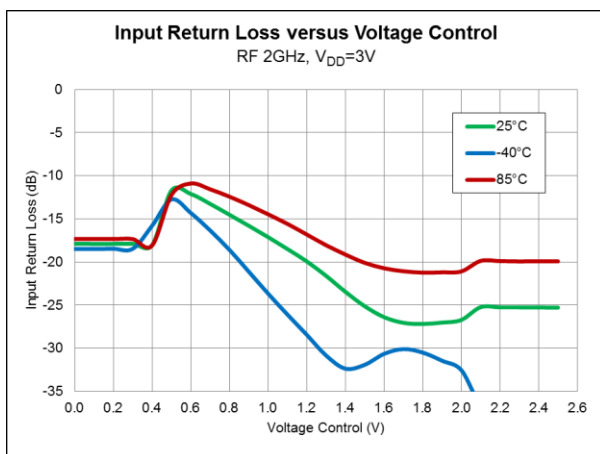
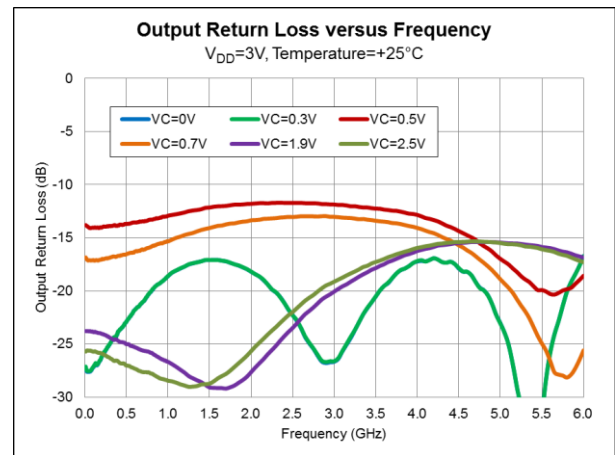
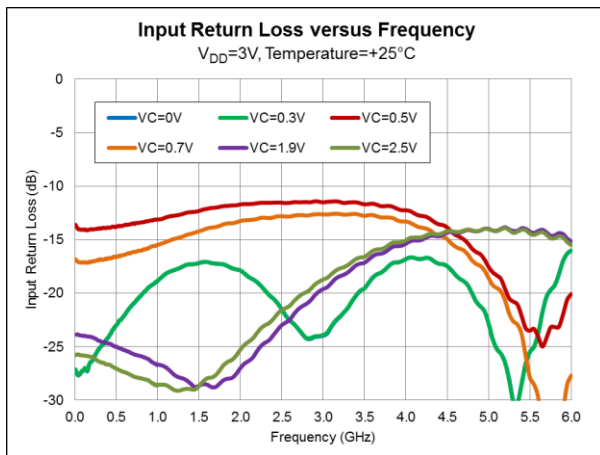
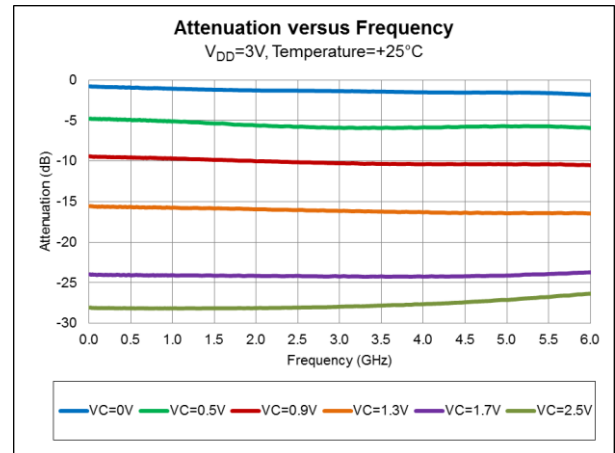
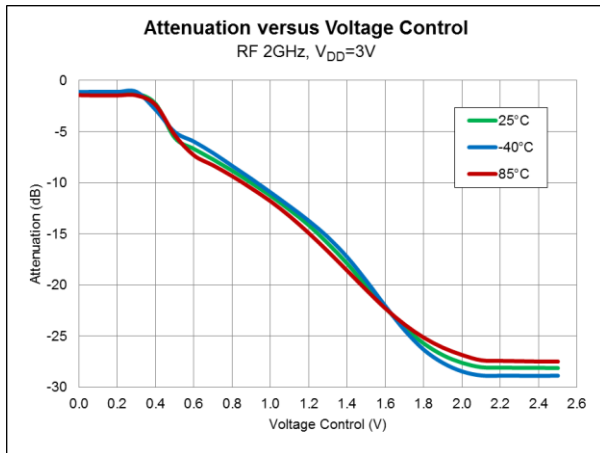

Measured Negative Attenuation Slope Performance

Note: 50Ω Application Circuit – Data includes PCB and connector losses

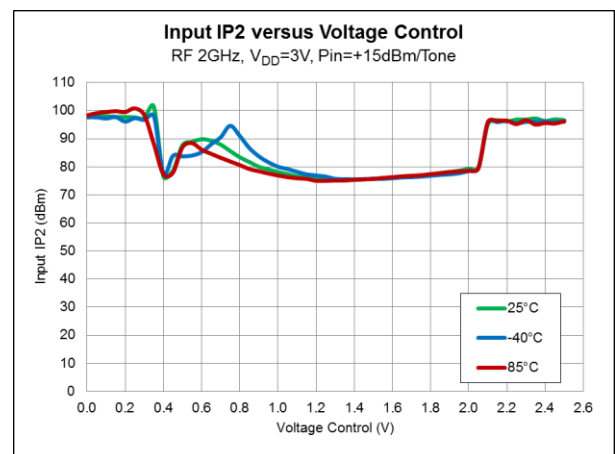
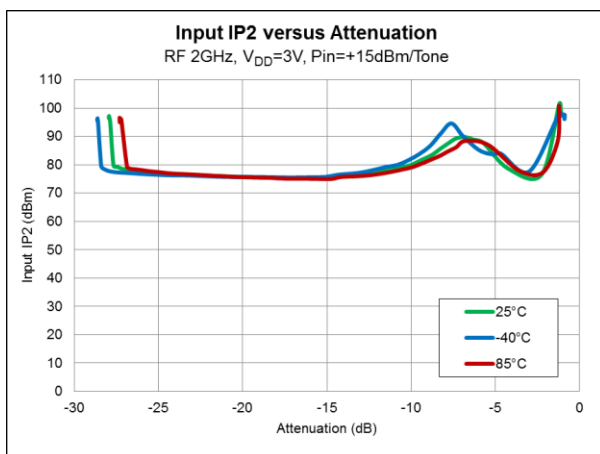
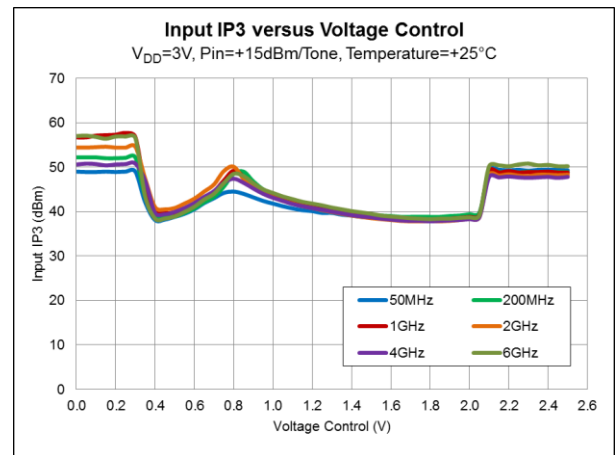
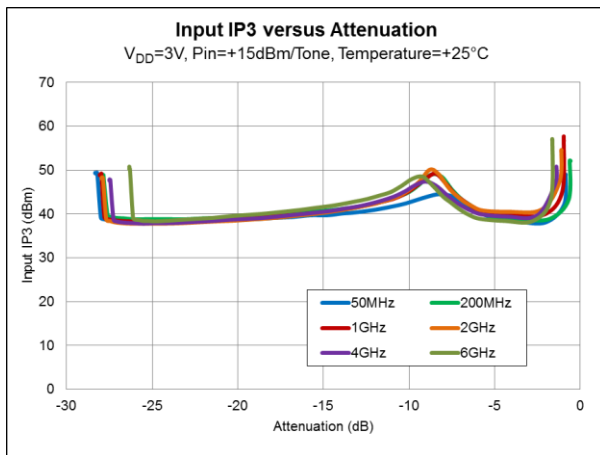
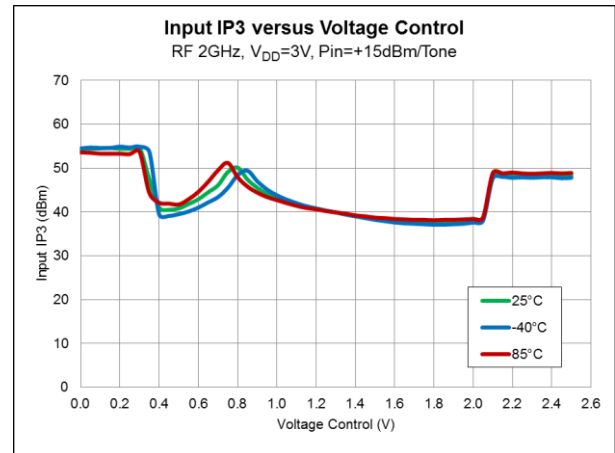
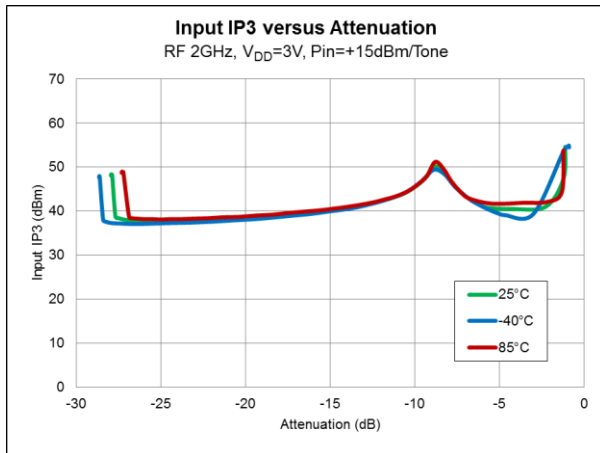

RF MICRO DEVICES®, RFMD®, Optimum Technology Matching®, Enabling Wireless Connectivity™, PowerStar®, POLARIS™ TOTAL RADIO™ and UltimateBlue™ are trademarks of RFMD, LLC. BLUETOOTH is a trademark owned by Bluetooth SIG, Inc. U.S.A. and licensed for use by RFMD. All other trade names, trademarks and registered trademarks are the property of their respective owners. ©2009, RF Micro Devices, Inc.

Measured Negative Attenuation Slope Performance

Note: 50Ω Application Circuit – Data includes PCB and connector losses

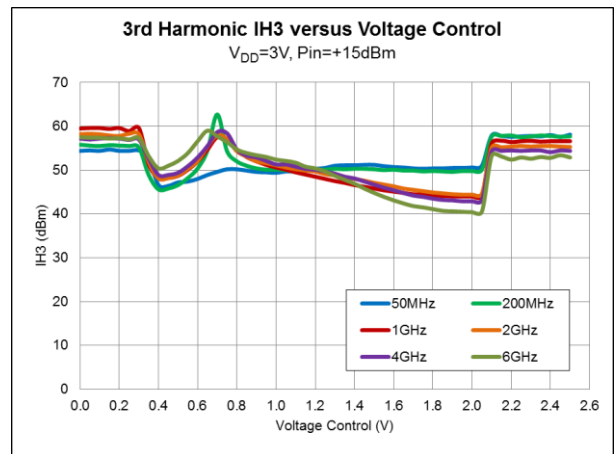
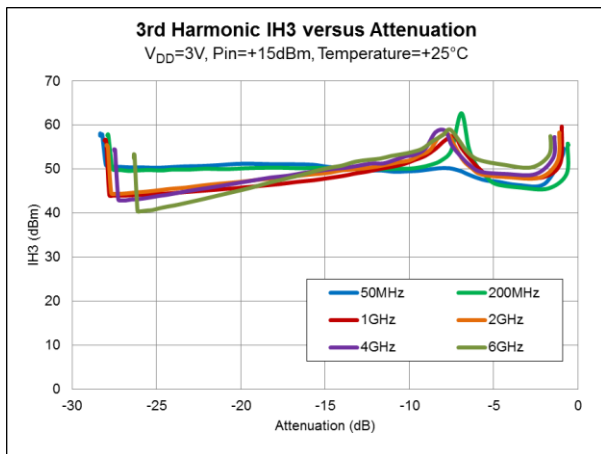
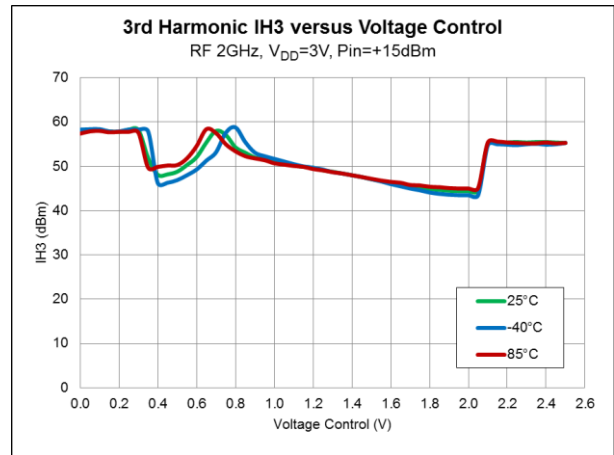
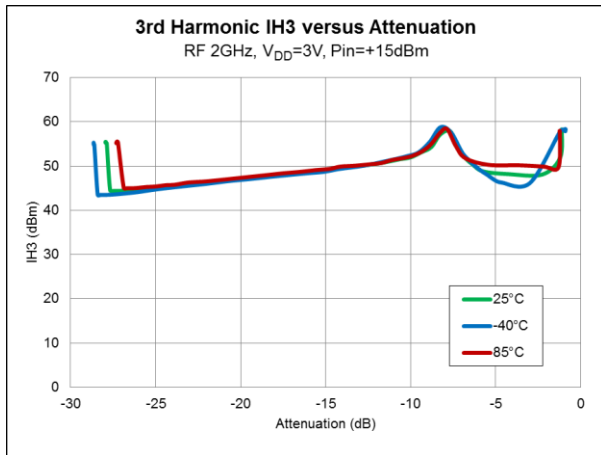
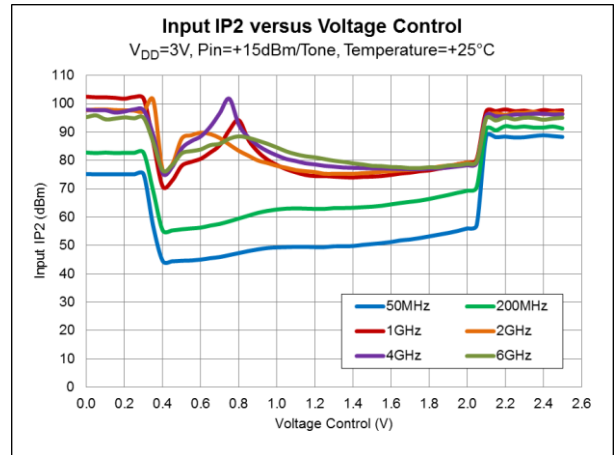
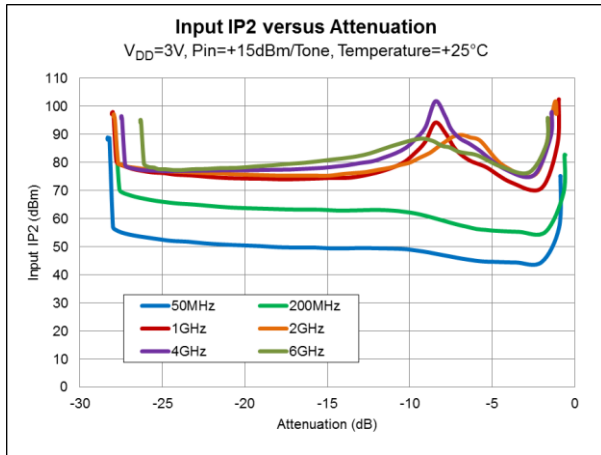

RF MICRO DEVICES®, RFMD®, Optimum Technology Matching®, Enabling Wireless Connectivity™, PowerStar®, POLARIS™ TOTAL RADIO™ and UltimateBlue™ are trademarks of RFMD, LLC. BLUETOOTH is a trademark owned by Bluetooth SIG, Inc., U.S.A. and licensed for use by RFMD. All other trade names, trademarks and registered trademarks are the property of their respective owners. ©2009, RF Micro Devices, Inc.

Measured Negative Attenuation Slope Performance

Note: 50Ω Application Circuit – Data includes PCB and connector losses

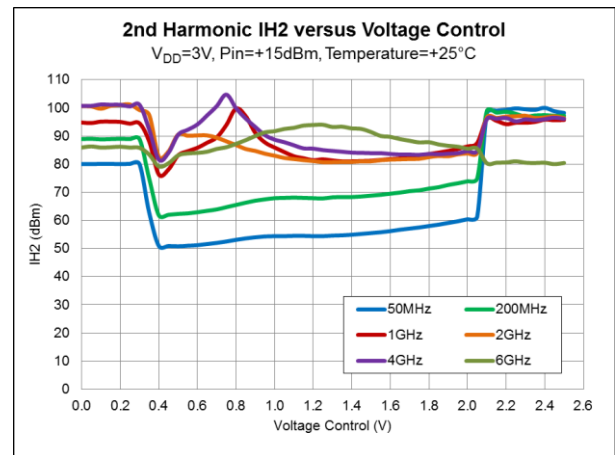
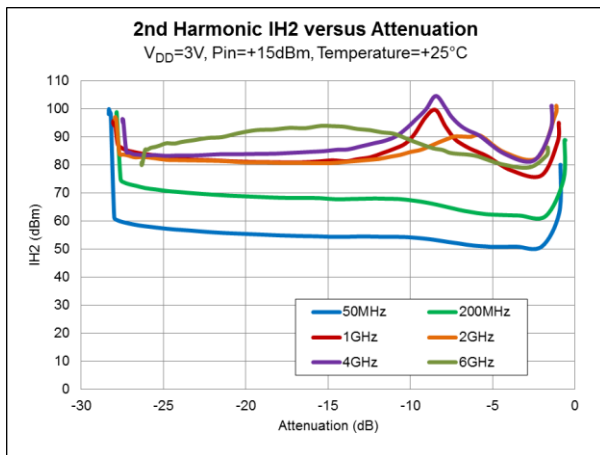
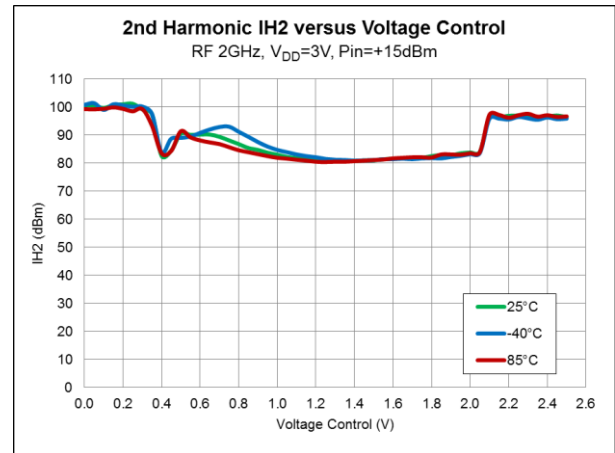
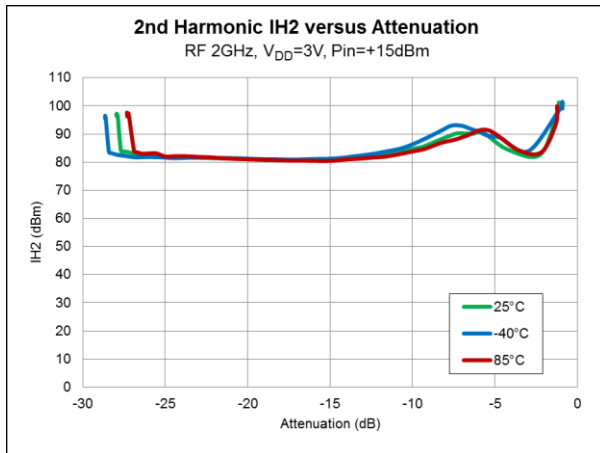

Measured Negative Attenuation Slope Performance

Note: 50Ω Application Circuit – Data includes PCB and connector losses

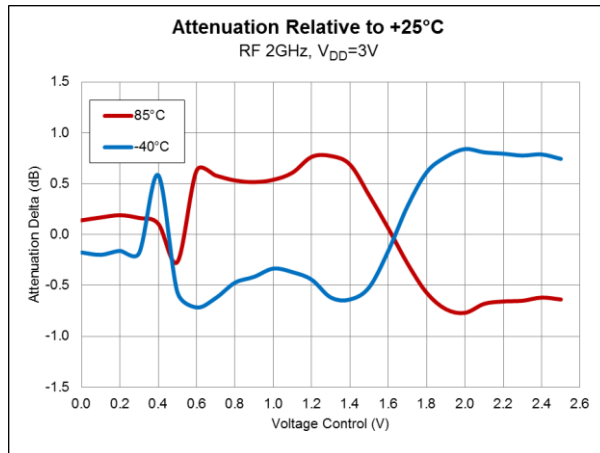
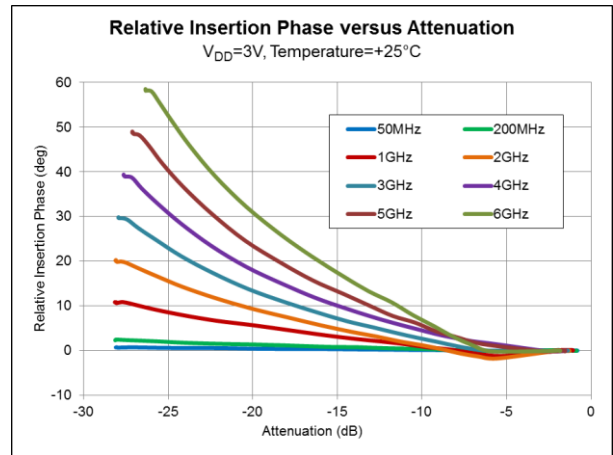
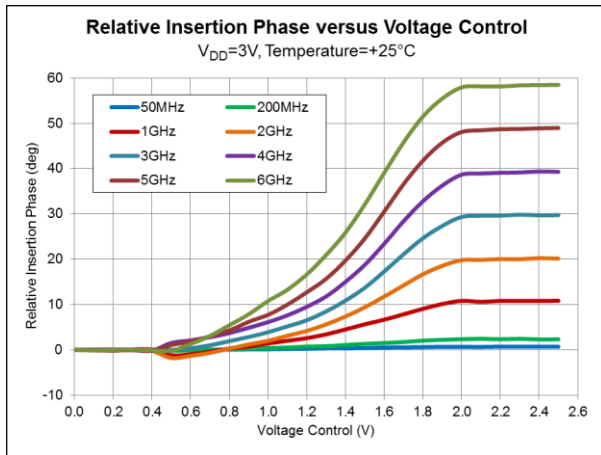

Evaluation Board Schematic 50Ω Application Circuit

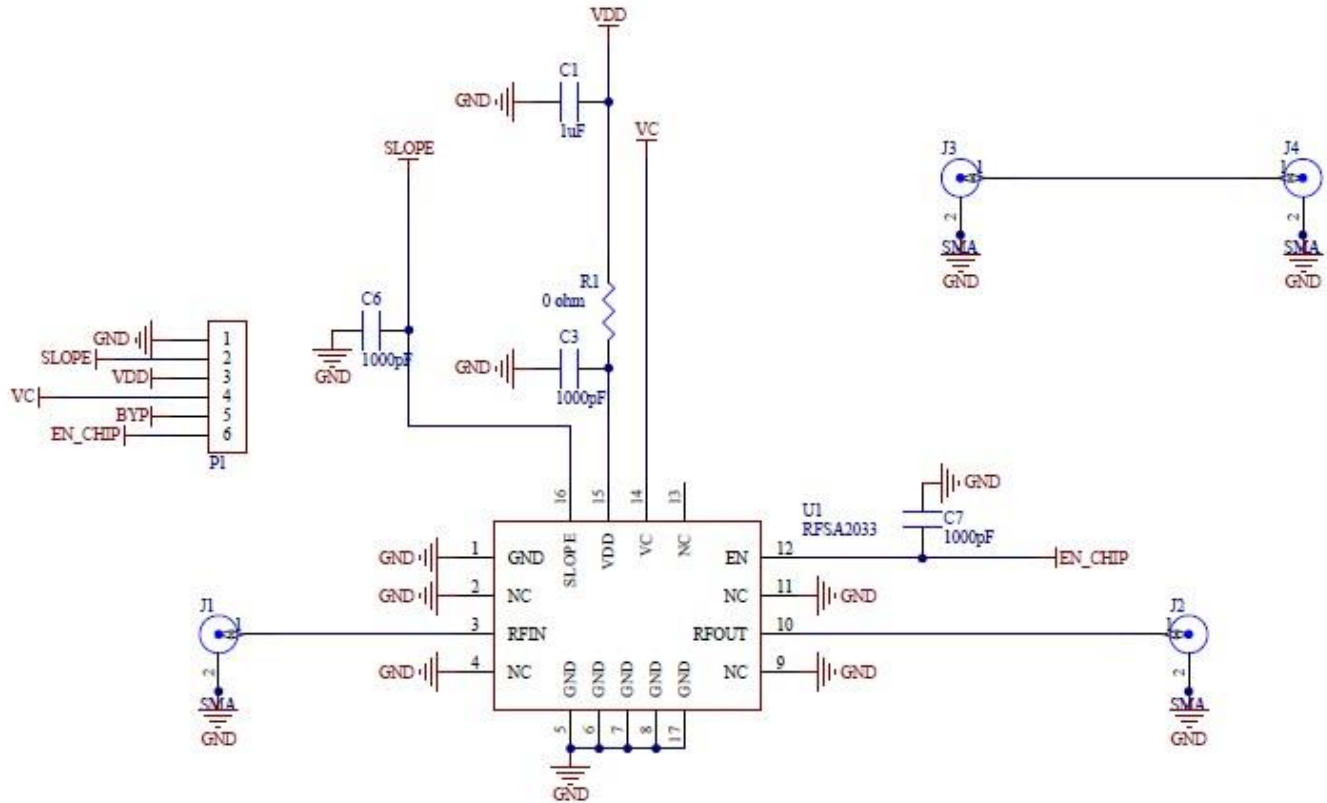

Evaluation Board Bill of Materials (BOM) 50Ω Application Circuit

Description	Reference Designator	Manufacturer	Manufacturer's P/N
Voltage Controlled Attenuator VCA	U1	RFMD	RFSA2033
CONN, SMA, END LNCH, RND PIN, 0.039"	J1-J4	Gigalane Co., Ltd.	PSF-S01-002
CONN, HDR, ST, 6-PIN, 0.100", T/H	P1	Molex	22-28-4063
PCB, SA2033-410		DDI	SA2033-410(A)
CAP, 1000pF, 10%, 25V, X7R, 0402	C3, C6-C7	Murata Electronics	GRM155R71H102KA01D
CAP, 1µF, 10%, 16V, X7R, 1206	C1	Murata Electronics	GRM31MR71E105KC01L
RES, 0Ω, 0402	R1	Kamaya, Inc	RMC1/16SJPTH
DNP	R2	N/A	N/A
DNP	C2, C4-C5	N/A	N/A

Evaluation Board Assembly Drawing 50Ω Application Circuit

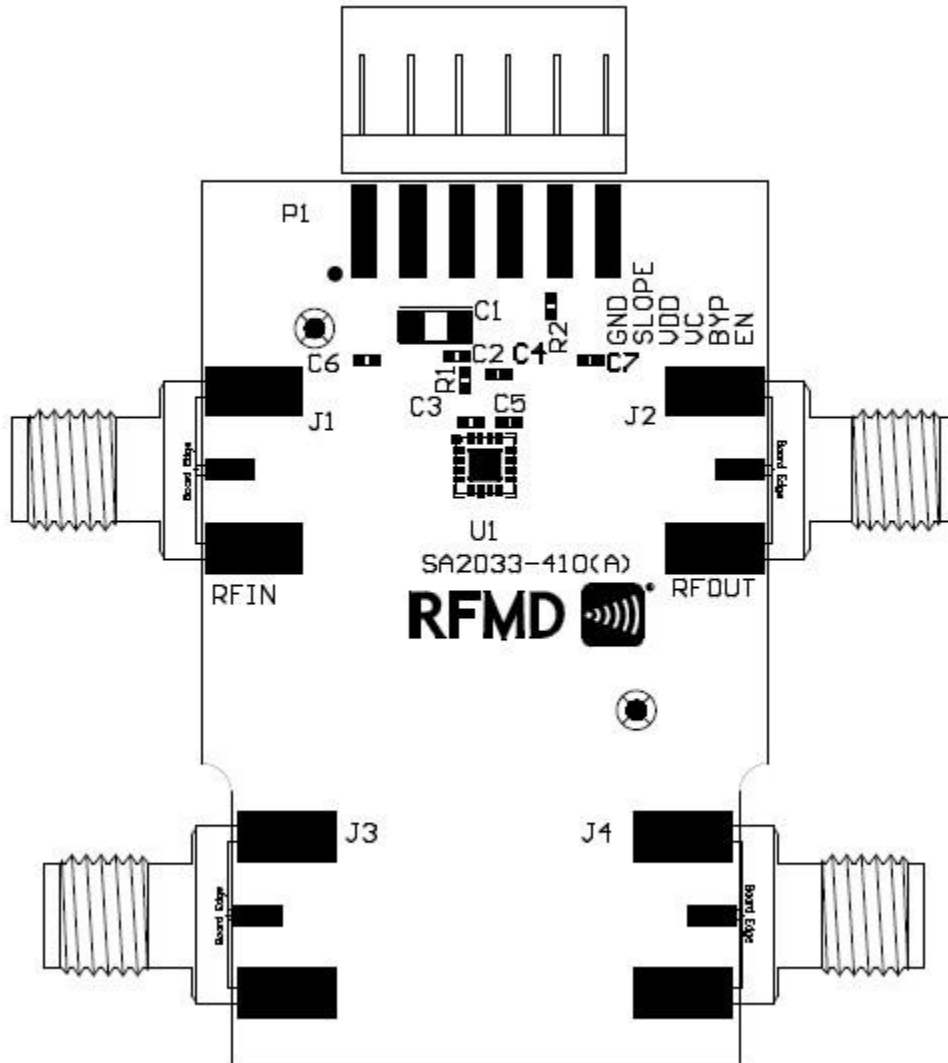

Measured CATV Positive Attenuation Slope Performance

Note: 75Ω Application Circuit

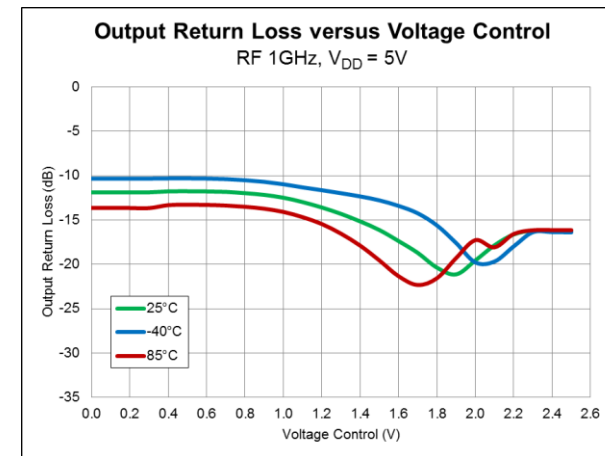
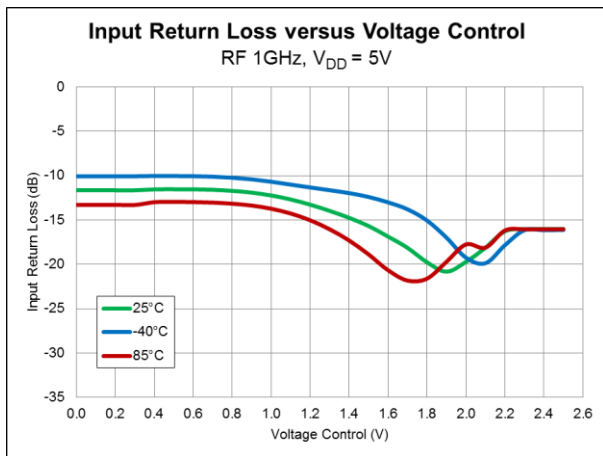
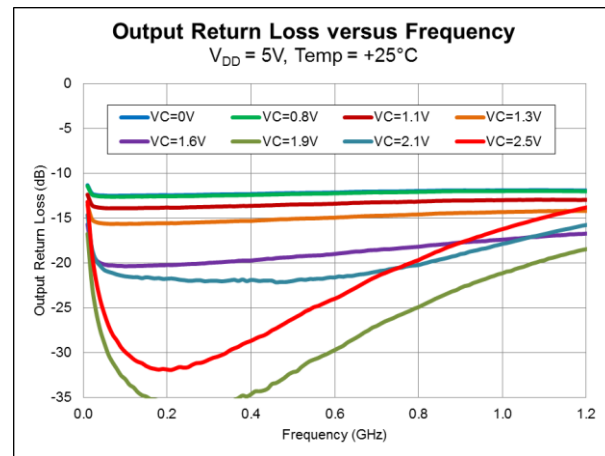
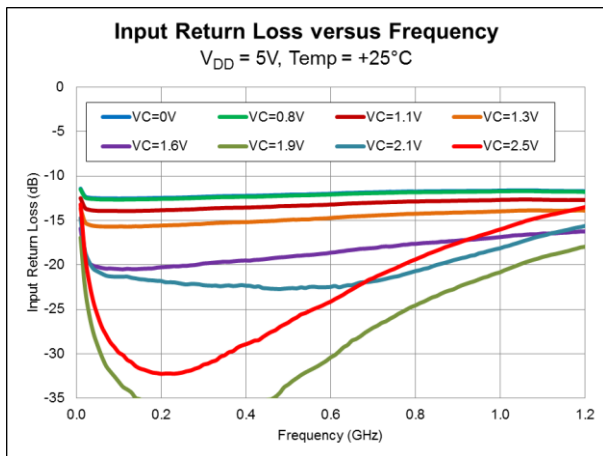
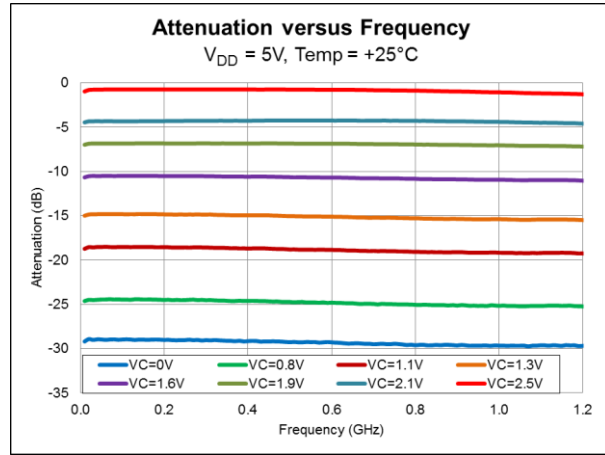
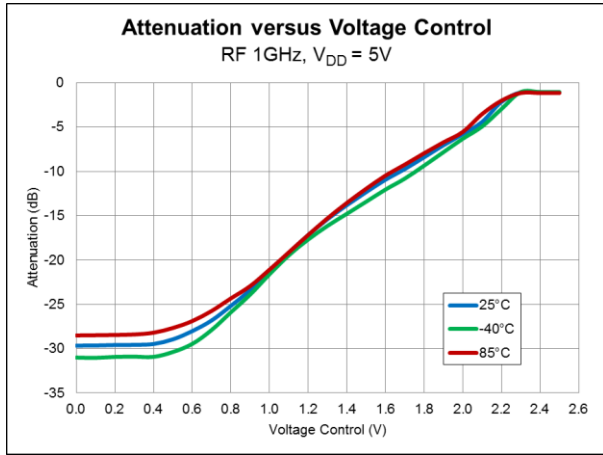

Measured CATV Composite Performance: 79 Channel Loading

Note: 75Ω Application Circuit

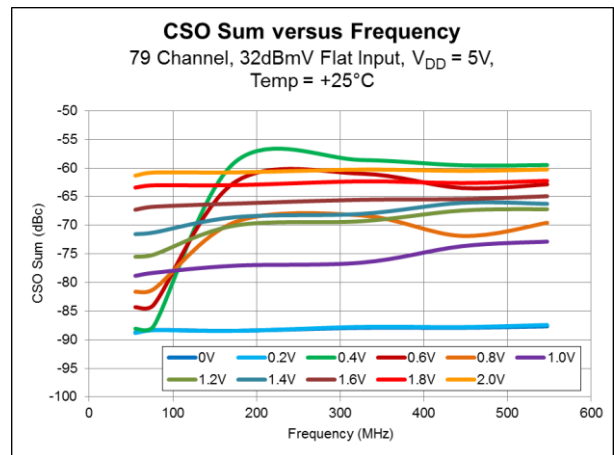
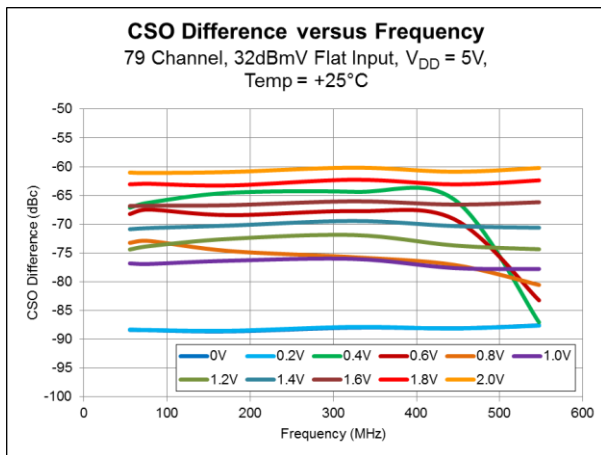
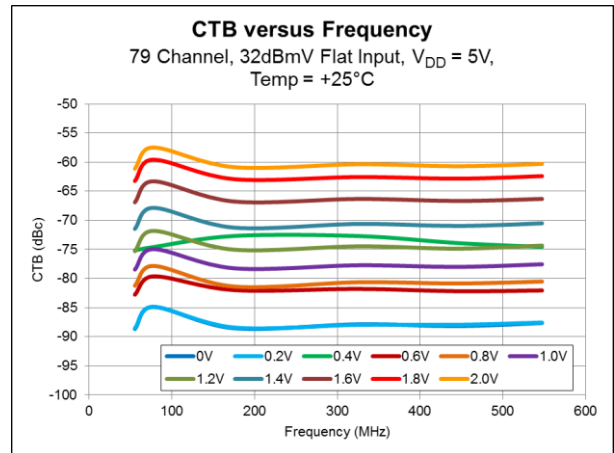
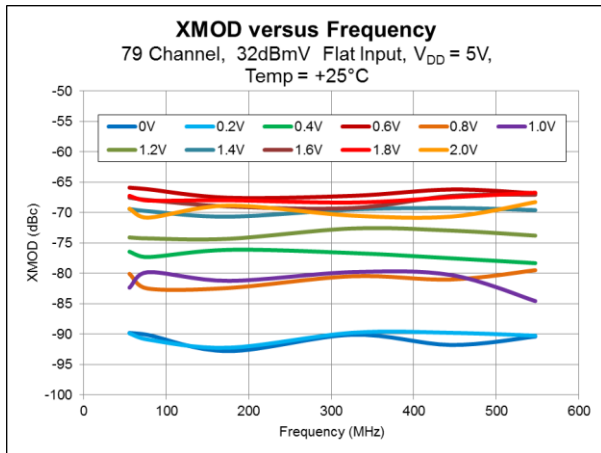

Measured CATV Composite Performance: 112 Channel Loading

Note: 75Ω Application Circuit

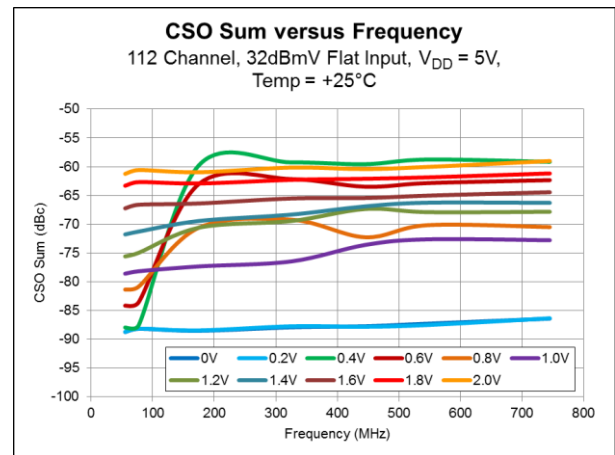
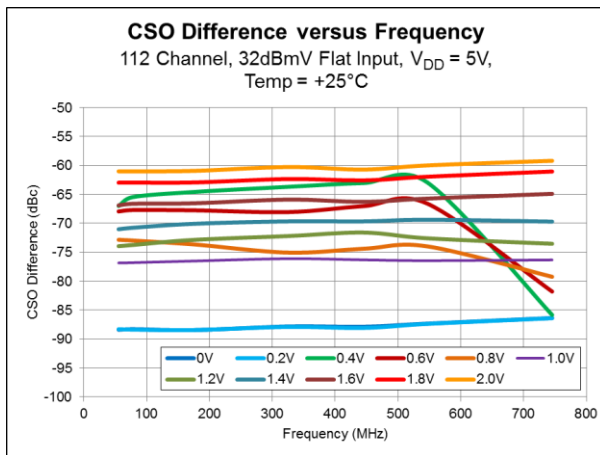
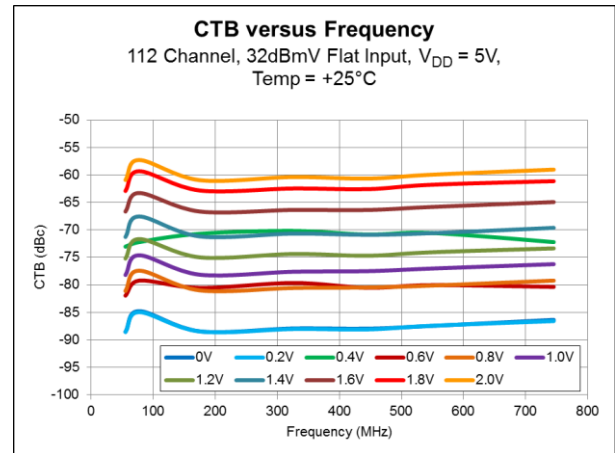
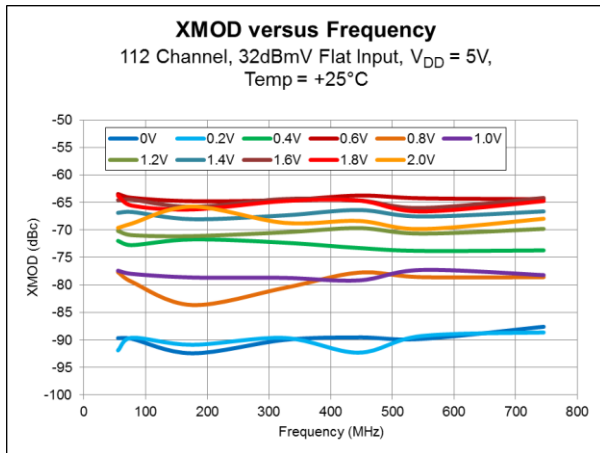

CATV Evaluation Board Schematic 75Ω Application Circuit

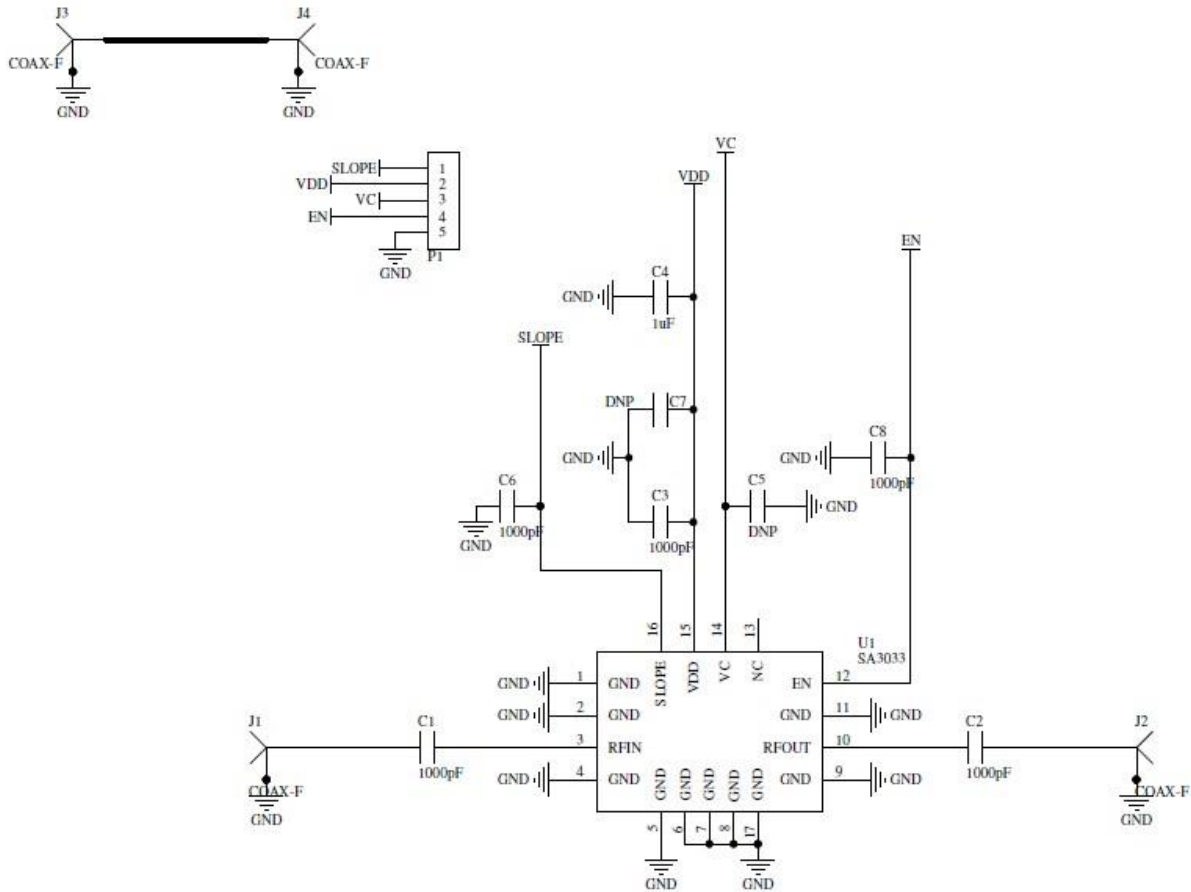

CATV Evaluation Board Bill of Materials (BOM)

Note: 75Ω Application Circuit

Description	Reference Designator	Manufacturer	Manufacturer's P/N
Voltage Controlled Attenuator VCA, 5V	U1	RFMD	RFSA3033
CONN, F, EDGE MOUNT, 30 MIL	J1-J4	Trompeter Electronics, Inc.	CBJE130-2
CONN, HDR, ST, 5-PIN, T/H	P1	Molex	22-28-4053
SA3033-410 Evaluation Board		DDI	SA3033-410(A)
CAP, 1000pF, 10%, 25V, X7R, 0402	C1-C3, C6, C8	Murata Electronics	GRM155R71H102KA01D
CAP, 1μF, 10%, 16V, X7R, 1206	C4	Murata Electronics	GRM31MR71E105KC01L
DNP	C5, C7	N/A	N/A

CATV Evaluation Board Assembly Drawing

Note: 75Ω Application Circuit

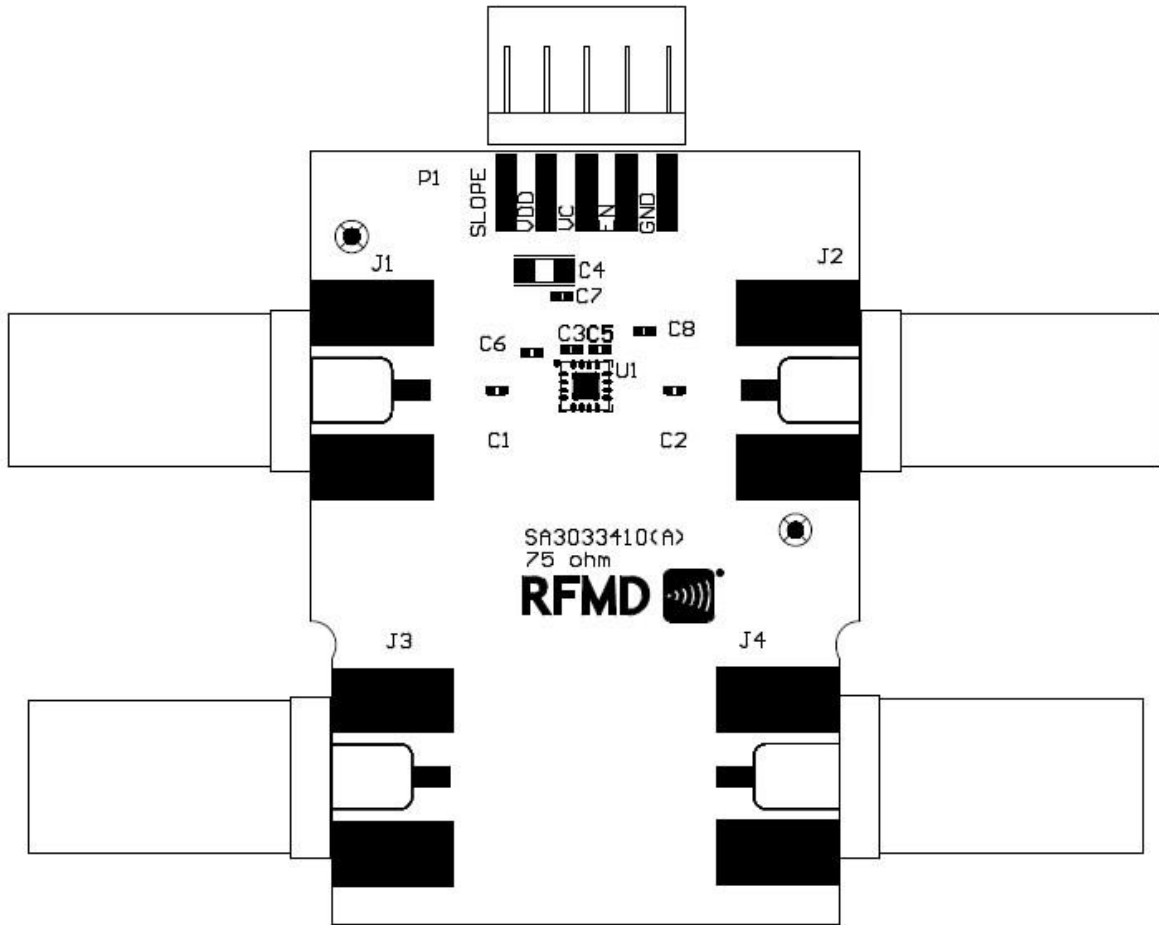

Pin Names and Description

Pin	Name	Description
1	GND	Ground Pin
2	GND	Ground Pin
3	RFIN	RF Input. Use External DC Block
4	GND	Ground Pin
5	GND	Ground Pin
6	GND	Ground Pin
7	GND	Ground Pin
8	GND	Ground Pin
9	GND	Ground Pin
10	RFOUT	RF Output. Use External DC Block
11	GND	Ground Pin
12	EN	Supply Current Enable Control. Connect to Logic Low to Enable. Connect to Logic High to Disable
13	NC	Floating Pin, No Connect.
14	VC	Attenuator Control Voltage
15	VDD	Supply Voltage
16	SLOPE	Attenuation Slope Control. Connect to Logic Low to Enable Negative Attenuation Slope. Connect to Logic High to Enable Positive Attenuation Slope.
GND	GND	Exposed Package Ground Paddle is RF and DC Ground.

Package Drawing

0.9mm x 3.0mm x 3.0mm Laminate Module

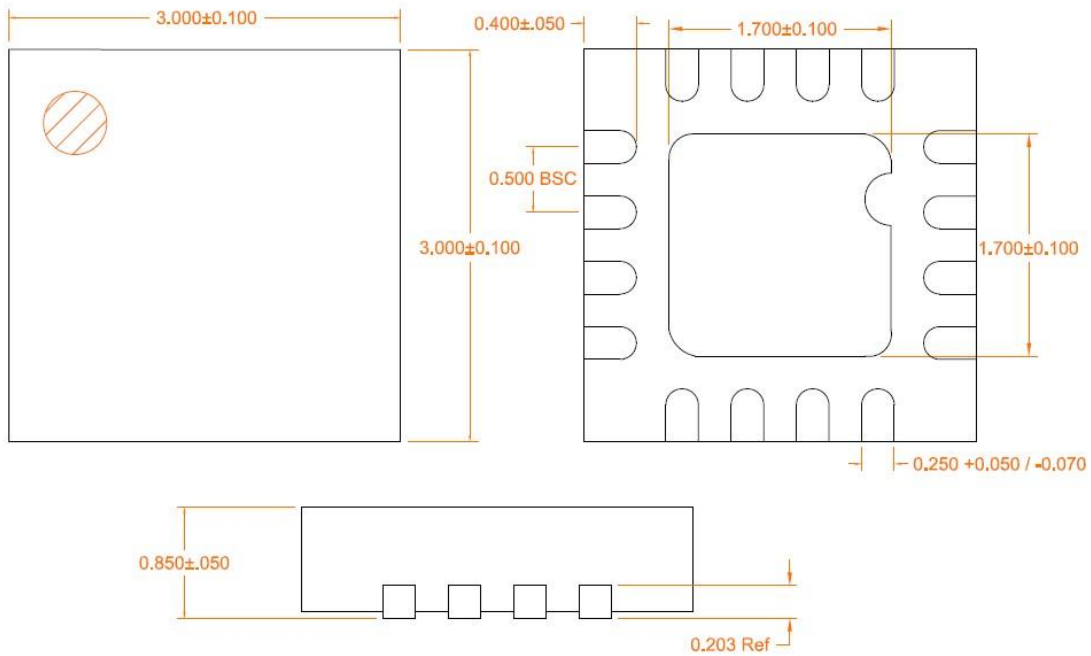

Branding Diagram

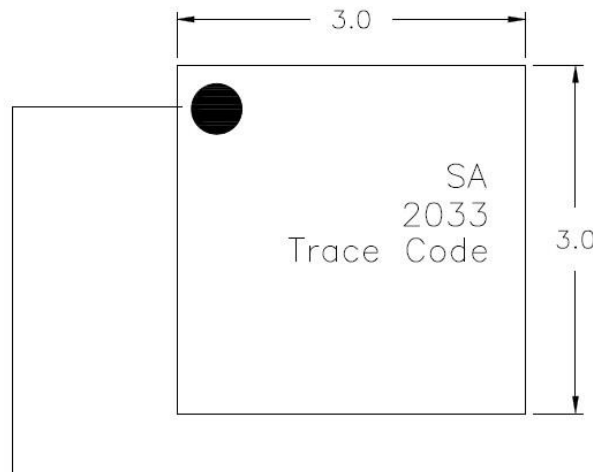

Pin 1 Indicator

Trace Code to be assigned by SubCon

X-ON Electronics

Largest Supplier of Electrical and Electronic Components

Click to view similar products for [Attenuators](#) category:

Click to view products by [Qorvo](#) manufacturer:

Other Similar products are found below :

[HMC305SLP4ETR](#) [MAAD-009195-000100](#) [TGL4201-00](#) [TGL4201-02](#) [TGL4201-03](#) [TGL4201-06](#) [TGL4201-10](#) [ATN3590-15](#) [20-50TPC](#)
[D10AA5Z4](#) [18AH-01](#) [18AH-08](#) [ATN3580-20](#) [ATN3590-09](#) [20-50RP](#) [MASW-008322-000000](#) [MAATCC0009TR](#) [PCAF-10](#) [EXB-](#)
[24AT9AR5X](#) [ATN3580-06](#) [ATN3580-10](#) [HMC539ALP3ETR](#) [ATN3580-02](#) [ATN3590-07](#) [SKY12408-321LF](#) [ATN3580-03](#)
[WA04P005XBTL](#) [HMC-VVD104-SX](#) [WA04P007XCTL](#) [SKY12236-11](#) [MAATSS0018TR-3000](#) [HMC656-SX](#) [WA04P001XBTL](#) [MAAV-](#)
[007941-TR3000](#) [WA04P004XBTL](#) [WA04P002XBTL](#) [C3A50Z4](#) [HMC941A](#) [PAT0816-C-0DB-T5](#) [PAT0816-C-8DB-T5](#) [PAT1632-C-3DB-](#)
[T1](#) [PAT1632-C-6DB-T1](#) [PAT1632-C-10DB-T1](#) [PAT1632-C-1DB-T1](#) [PAT0816-C-2DB-T5](#) [PAT0816-C-4DB-T5](#) [DHM510-0100-006](#)
[CMD172](#) [MAT10300](#) [MAT10180](#)