



Package: QFN, 16-Pin, 0.9mm x 3mm x 3mm



Features

- Patent Pending Circuit Architecture
- Broadband 50MHz to 6000MHz Frequency Range
- 3 Selectable Attenuation versus Temperature Slopes
- +55dBm IIP3 Typical
- +85dBm IIP2 Typical
- High 1dB Compression Point >+30dBm
- Low Supply Current 1mA Typical
- 5V Power Supply
- Class 1C ESD (1000V)
- Complete Solution in a Small 3mm x 3mm QFN Package
- 3.3V Part Available - RFSA4023

Applications

- Cellular, 3G Infrastructure
- WiBro, WiMax, LTE
- Microwave Radio
- High-Linearity Level Control

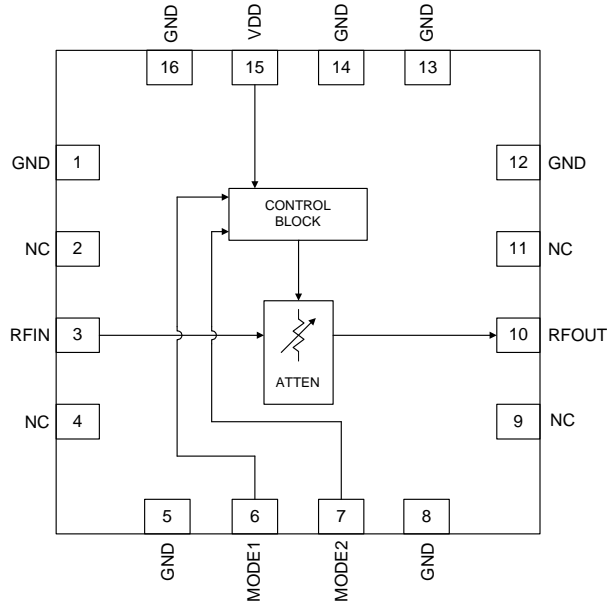

Functional Block Diagram

Product Description

RFMD's RFSA4013 is a fully monolithic analog temperature compensating attenuator (TCA) featuring exceptional linearity over its entire gain control range. It is designed to offset the gain reduction of an RF component over temperature without the need for closed loop feedback. Three customer selectable temperature coefficients make it a flexible solution for RF lineups. It incorporates revolutionary new circuit architecture to solve a long standing industry problem with regards to attenuator architecture: high IP3, low DC current and broad bandwidth. Traditional approaches for solving this problem require expensive co-fired ceramics with temperature sensitive materials or current hungry PIN diodes with elaborate area consuming control circuits. This temperature compensating attenuator requires only a single supply voltage and two logic bits to set control attenuation slope versus temperature. The RFSA4013 draws a very low 1mA current and is packaged in a small 3mm x 3mm QFN. This attenuator is matched to 50Ω over its rated control range and frequency with no external matching components required.

Ordering Information

RFSA4013SQ	Sample bag with 25 pieces
RFSA4013SR	7" Sample reel with 100 pieces
RFSA4013TR7	7" Reel with 2500 pieces
RFSA4013PCK-410	50MHz to 6000MHz PCBA with 5-piece sample bag

Optimum Technology Matching® Applied

- | | | | |
|--------------------------------------|--------------------------------------|---|------------------------------------|
| <input type="checkbox"/> GaAs HBT | <input type="checkbox"/> SiGe BiCMOS | <input type="checkbox"/> GaAs pHEMT | <input type="checkbox"/> GaN HEMT |
| <input type="checkbox"/> GaAs MESFET | <input type="checkbox"/> Si BiCMOS | <input checked="" type="checkbox"/> Si CMOS | <input type="checkbox"/> BiFET HBT |
| <input type="checkbox"/> InGaP HBT | <input type="checkbox"/> SiGe HBT | <input type="checkbox"/> Si BJT | |

RF MICRO DEVICES®, RFMD®, Optimum Technology Matching®, Enabling Wireless Connectivity™, PowerStar®, POLARIS™ TOTAL RADIO™ and UltimateBlue™ are trademarks of RFMD, LLC. BLUETOOTH is a trademark owned by Bluetooth SIG, Inc., U.S.A. and licensed for use by RFMD. All other trade names, trademarks and registered trademarks are the property of their respective owners. ©2012, RF Micro Devices, Inc.

Absolute Maximum Ratings

Parameter	Rating	Unit
Supply Voltage (V_{DD})	-0.5 to +6.0	V
Mode Pin Voltage (MODE 1)	-0.5 to +6.0	V
Mode Pin Voltage (MODE 2)	-0.5 to +6.0	V
RF Input Power	+30	dBm
Operating Temperature	-40 to +85	°C
Storage Temperature	-65 to +150	°C
Maximum Junction Temperature	+125	°C
ESD - Human Body Model (HBM)	1000	V



Caution! ESD sensitive device.

Exceeding any one or a combination of the Absolute Maximum Rating conditions may cause permanent damage to the device. Extended application of Absolute Maximum Rating conditions to the device may reduce device reliability. Specified typical performance or functional operation of the device under Absolute Maximum Rating conditions is not implied.

The information in this publication is believed to be accurate and reliable. However, no responsibility is assumed by RF Micro Devices, Inc. ("RFMD") for its use, nor for any infringement of patents, or other rights of third parties, resulting from its use. No license is granted by implication or otherwise under any patent or patent rights of RFMD. RFMD reserves the right to change component circuitry, recommended application circuitry and specifications at any time without prior notice.



RFMD Green: RoHS compliant per EU Directive 2002/95/EC, halogen free per IEC 61249-2-21, < 1000ppm each of antimony trioxide in polymeric materials and red phosphorus as a flame retardant, and <2% antimony in solder.

Parameter	Specification			Unit	Condition
	Min.	Typ.	Max.		
General					
Supply Voltage (V_{DD})	4.75	5	5.25	V	
Supply Current		1		mA	
Operating Temperature	-40		85	°C	
Thermal Resistance		45		°C/W	
RF Input Power			27	dBm	
RF Performance					
Frequency Range	50		6000	MHz	
Attenuation Slope Mode1 = Low Mode2 = High		0.043		dB/°C	-40°C to 80°C
Attenuation Slope Mode1 = High Mode2 = High		0.058		dB/°C	-40°C to 80°C
Attenuation Slope Mode1 = High Mode2 = Low		0.066		dB/°C	-40°C to 80°C
Nominal +25°C Attenuation Mode1 = Low Mode2 = High		5.4		dB	
Nominal +25°C Attenuation Mode1 = High Mode2 = High		6.35		dB	
Nominal +25°C Attenuation Mode1 = High Mode2 = Low		7.4		dB	
Relative Phase		3		Deg	Insertion Phase at +25°C temperature relative to max temperature
Return Loss		20		dB	
Input 1dB Compression Point		30		dBm	
Input IP3	45	55		dBm	$P_{IN} + (IM3_{dBc}/2)$
Input IP2		85		dBm	$P_{IN} + IM2_{dBc}$, IM2 is F1 + F2
Input IH2		87		dBm	$P_{IN} + H2_{dBc}$, H2 is Second Harmonic
Input IH3		59		dBm	$P_{IN} + (H3_{dBc}/2)$, H3 is Third Harmonic
Power Supply					
MODE pin Logic Low			+0.4	V	
MODE pin Logic High	1			V	

NOTE: Typical performance at nominal conditions unless otherwise noted: Supply voltage = 5.0V, Operating temperature = 25°C, RF frequency 2GHz

Measured Performance

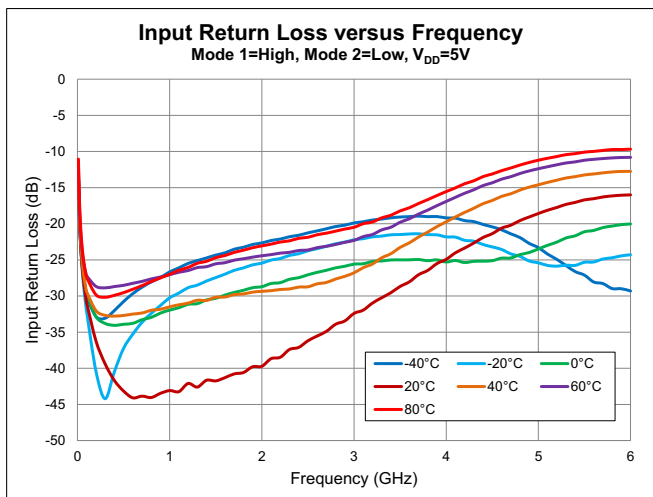
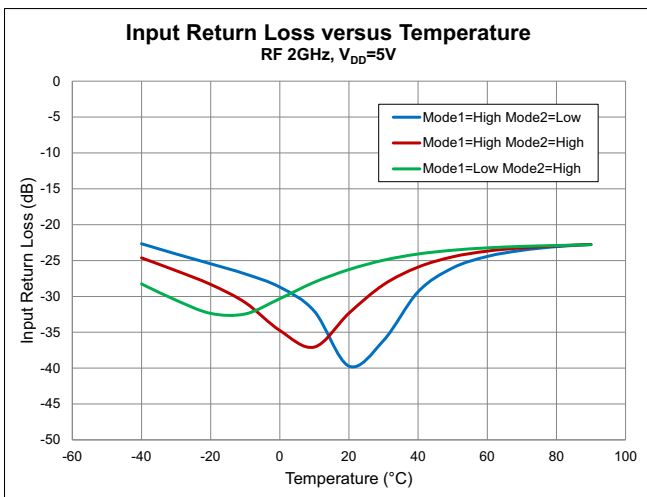
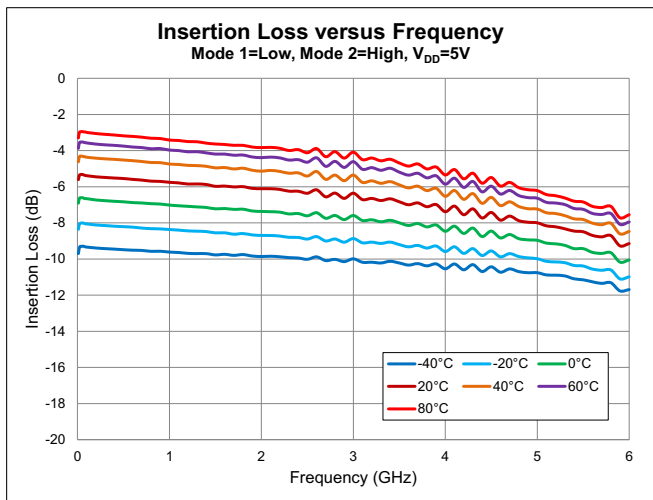
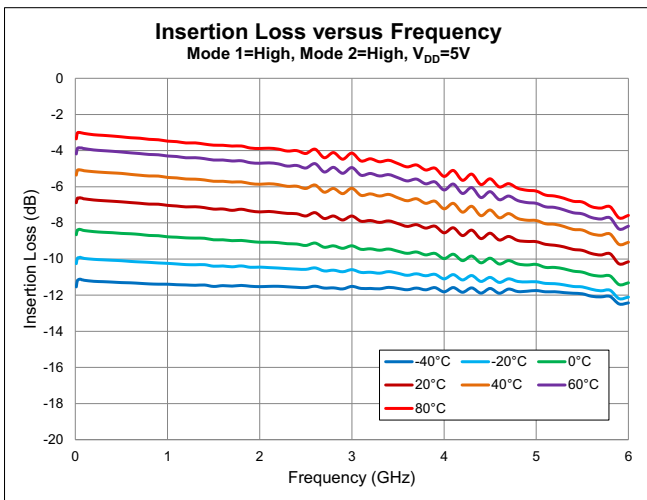
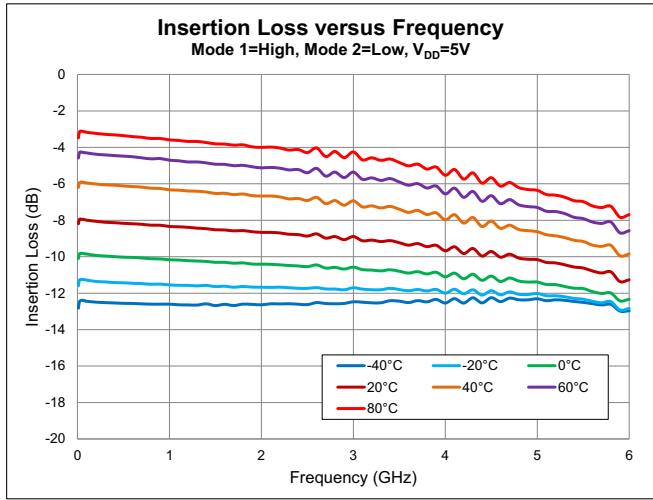
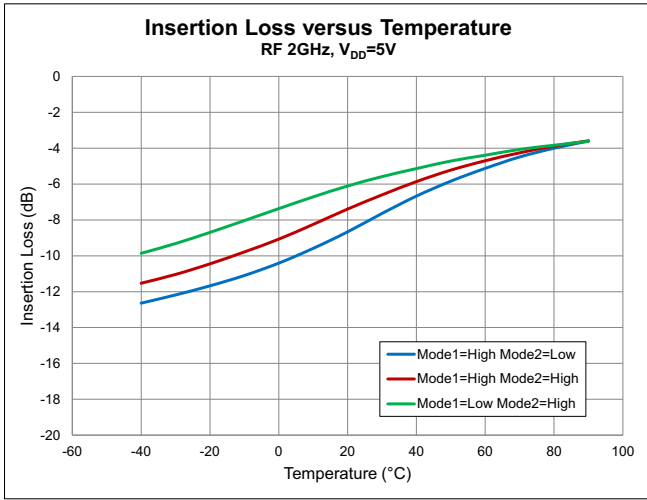

Measured Performance

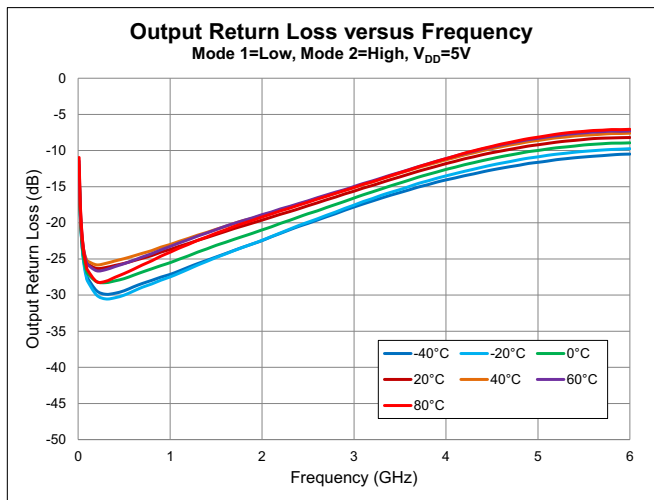
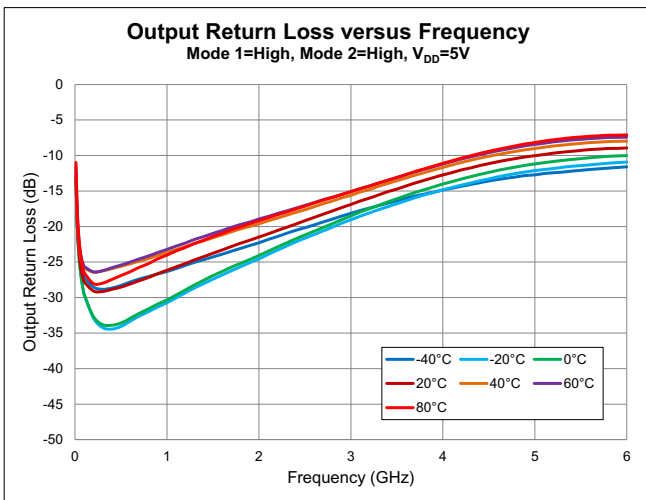
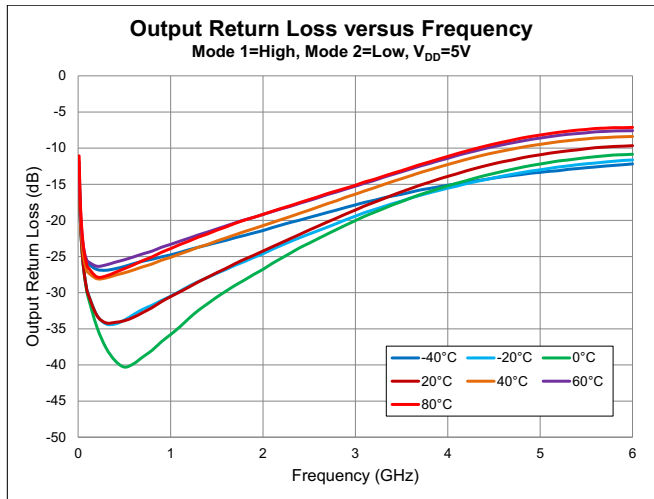
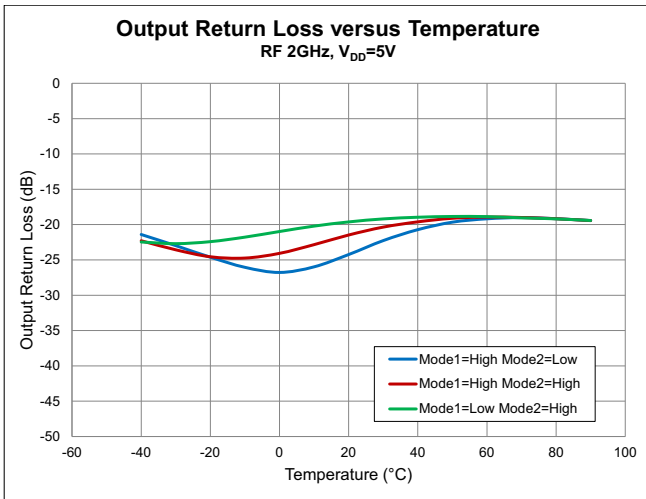
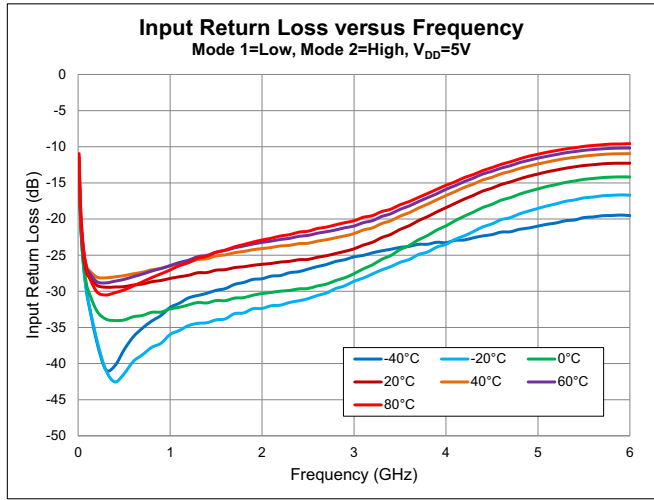
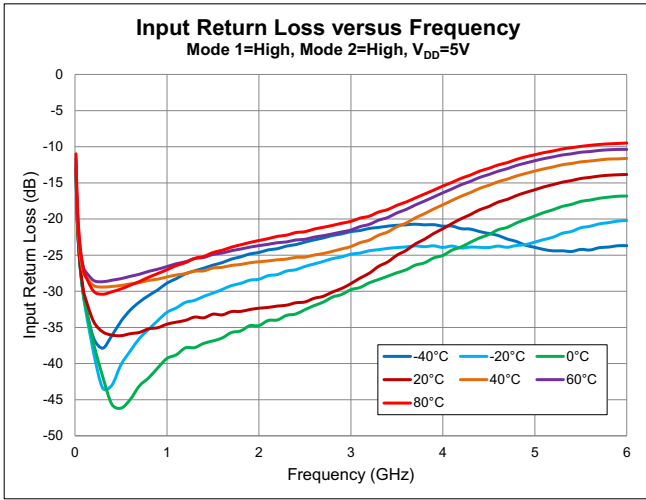

Measured Performance

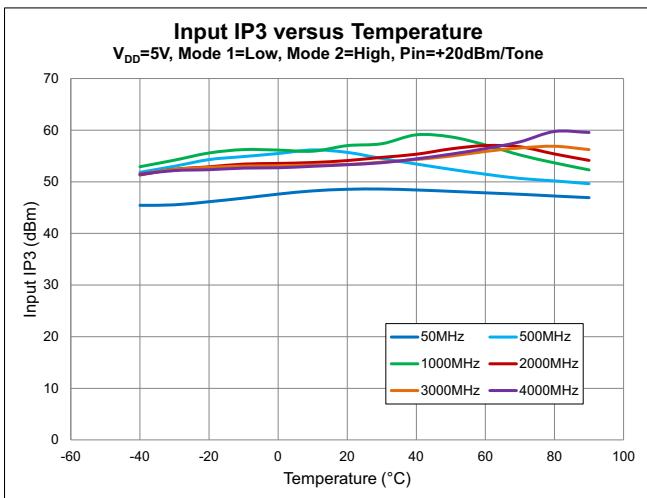
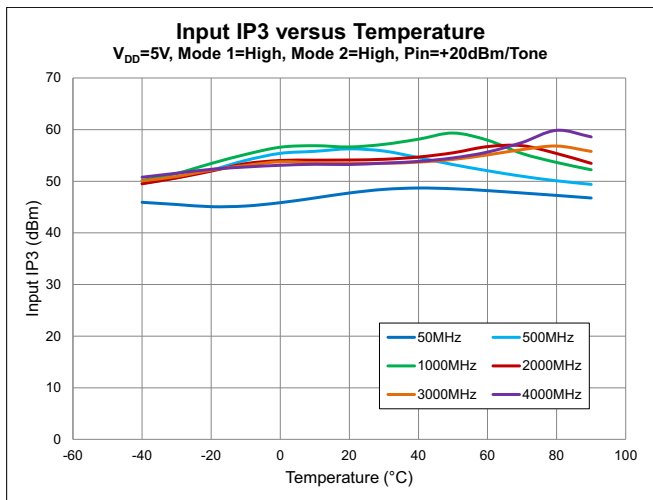
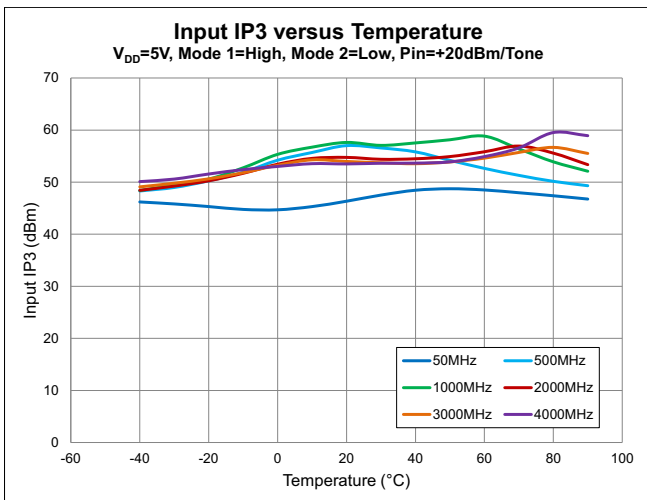
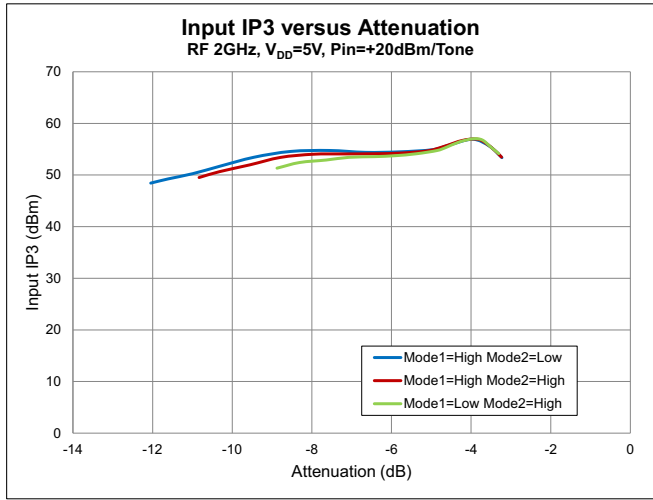
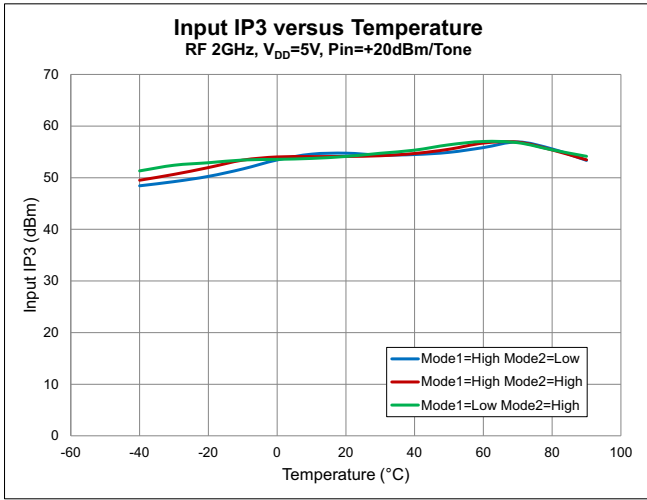

Measured Performance

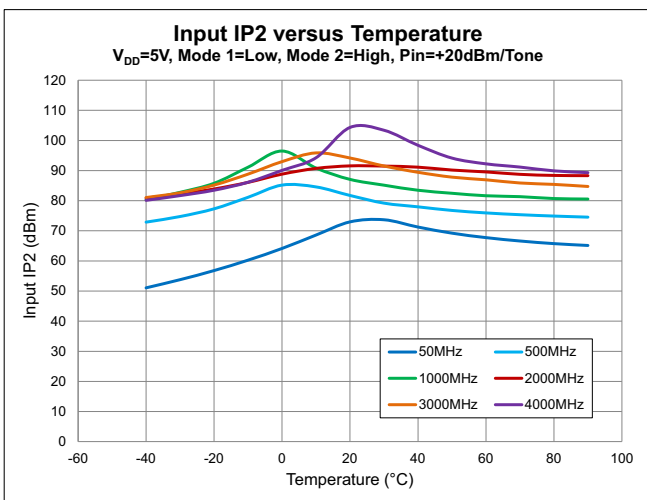
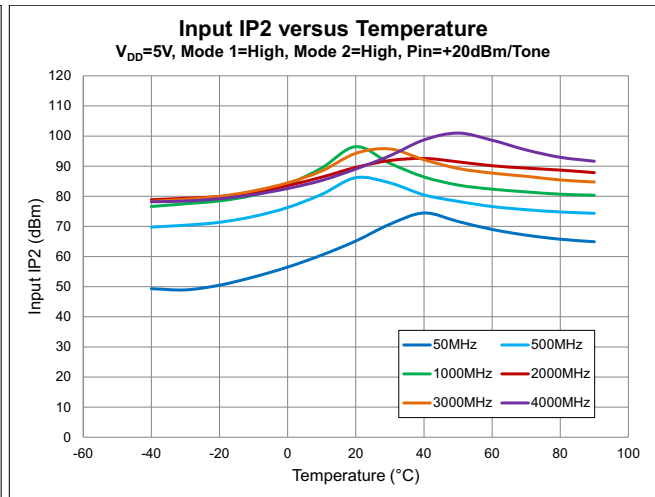
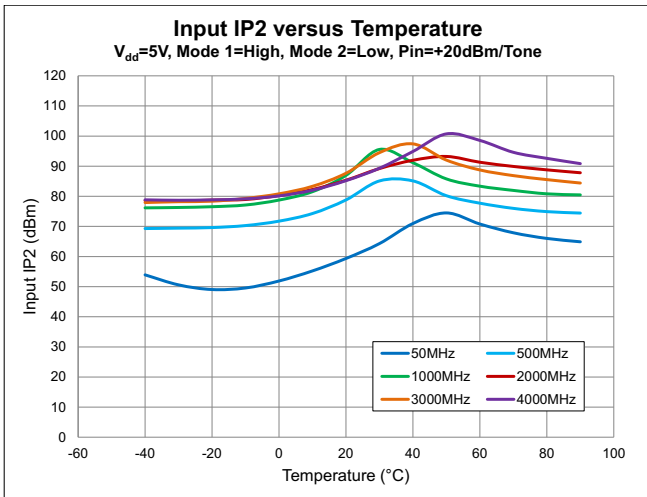
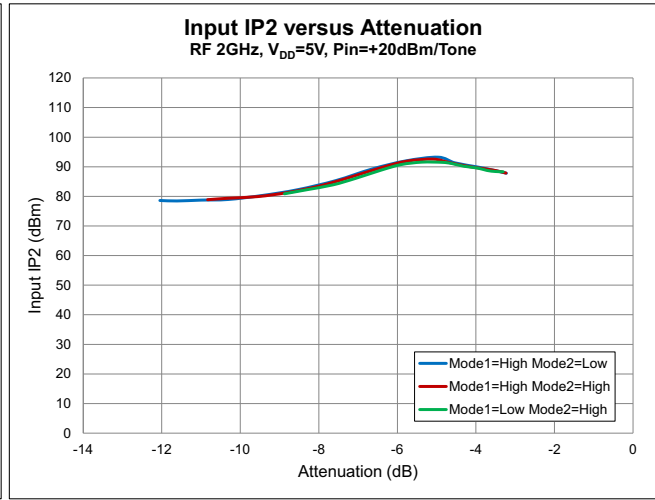
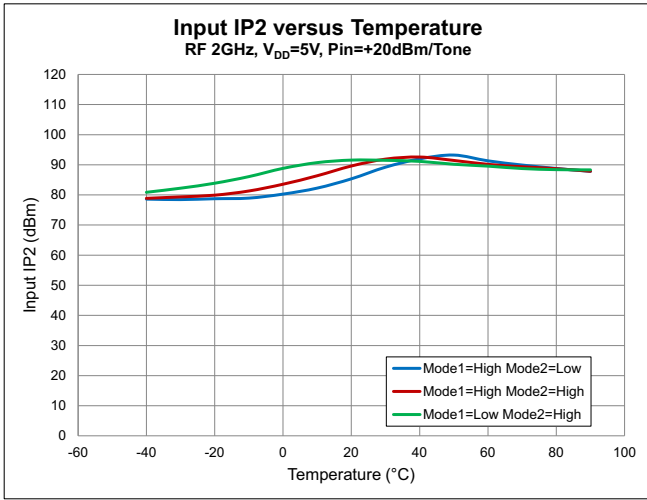

Measured Performance

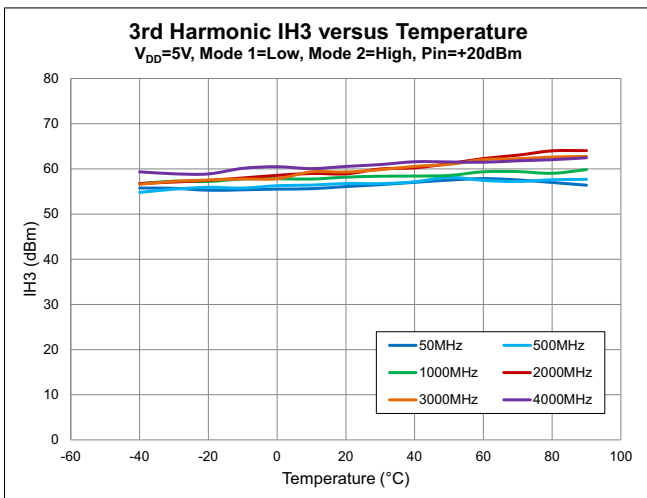
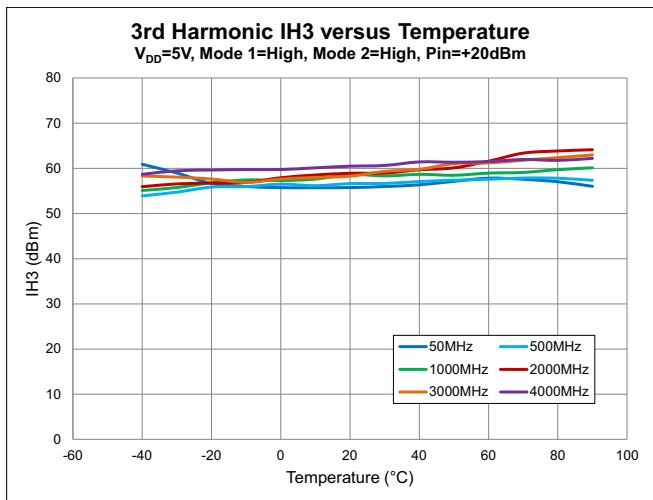
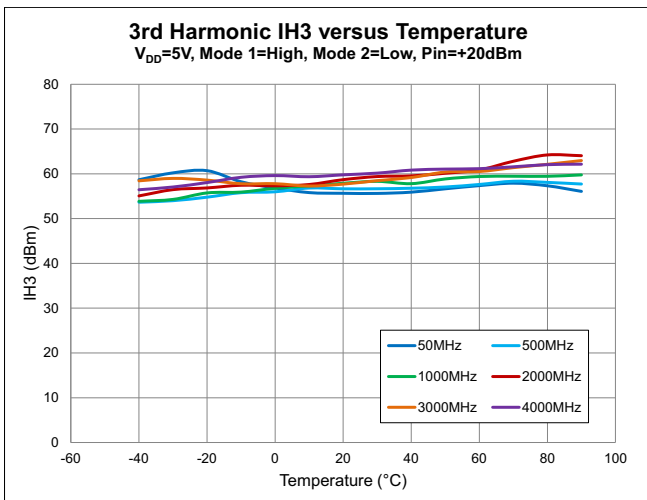
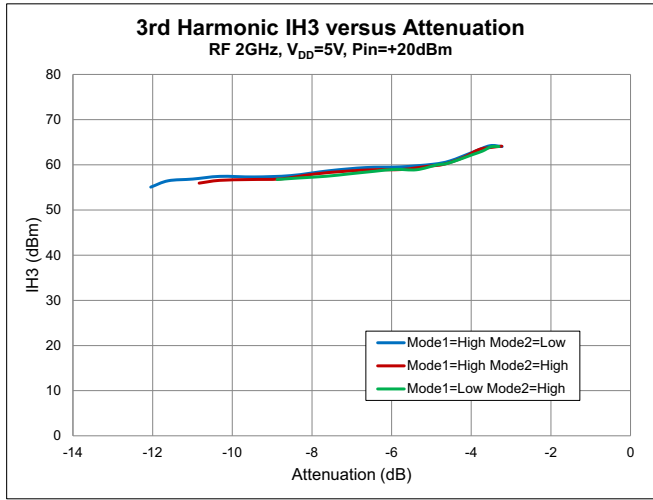
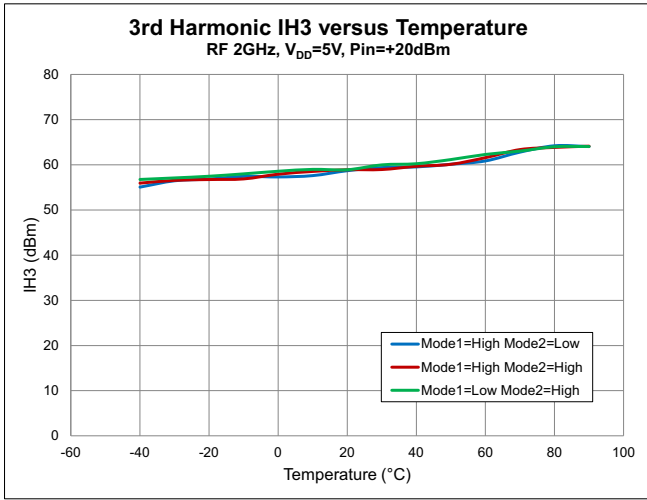

Measured Performance

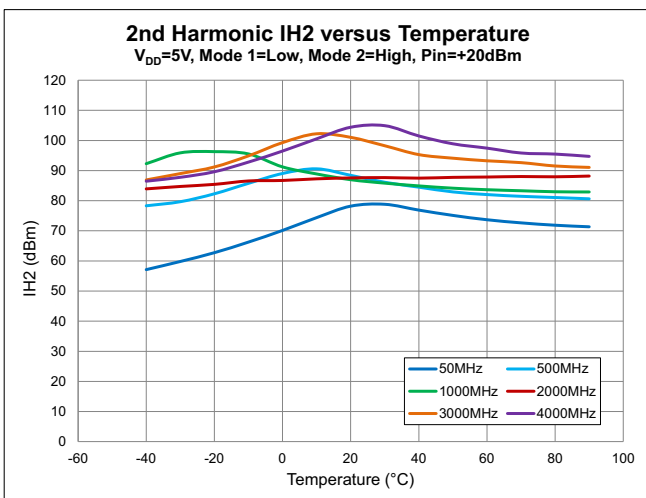
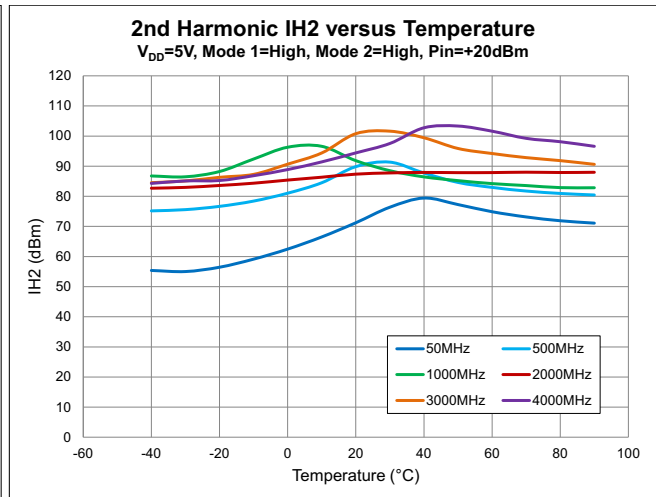
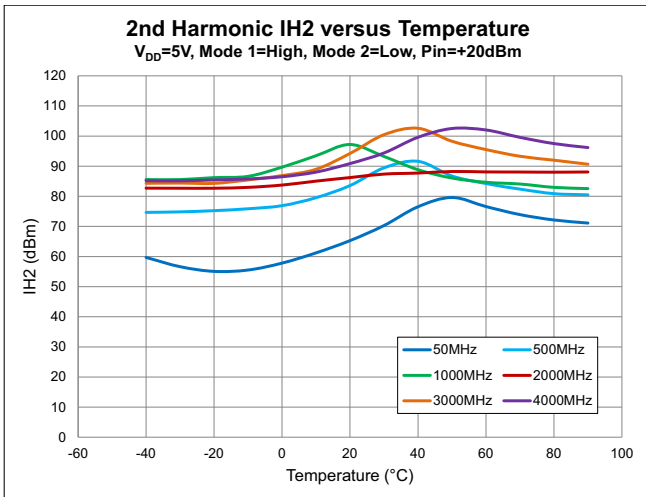
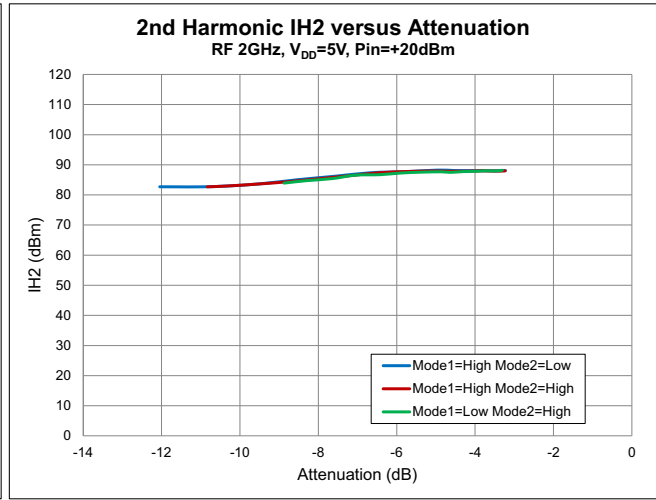
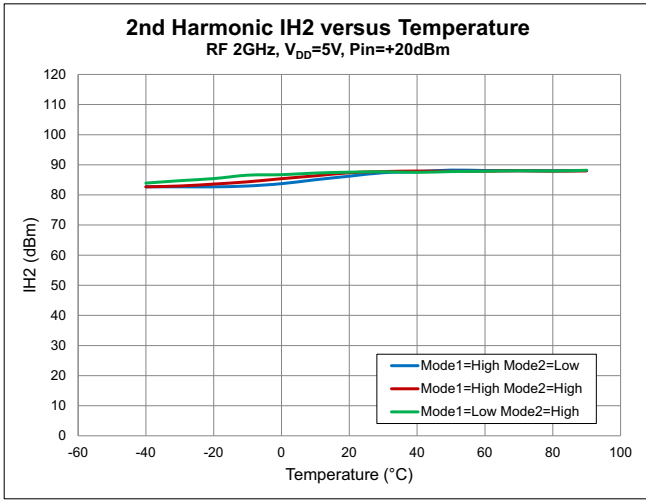

Measured Performance

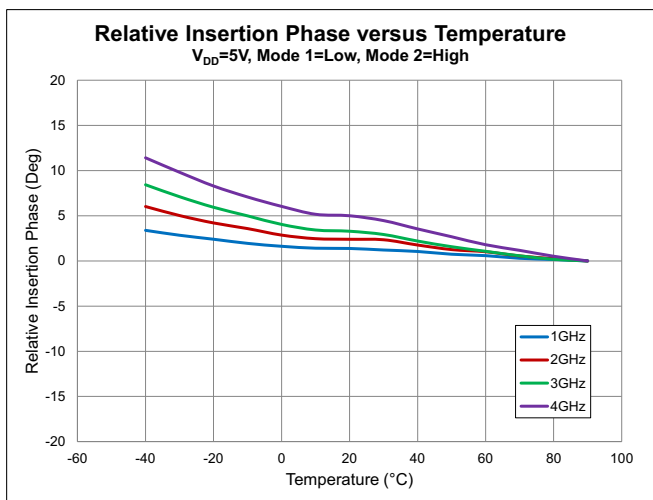
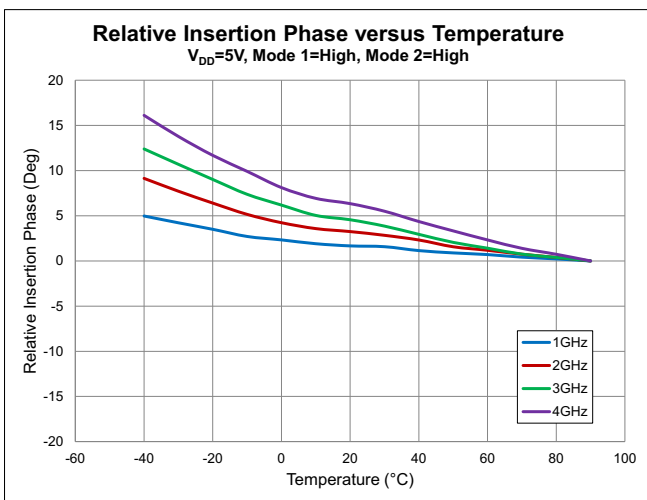
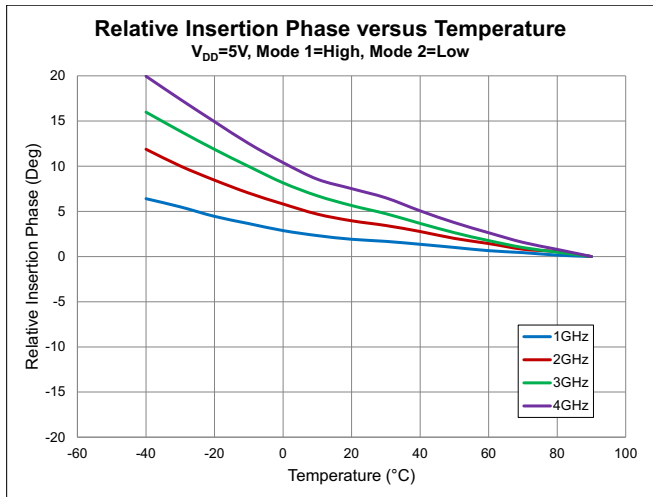
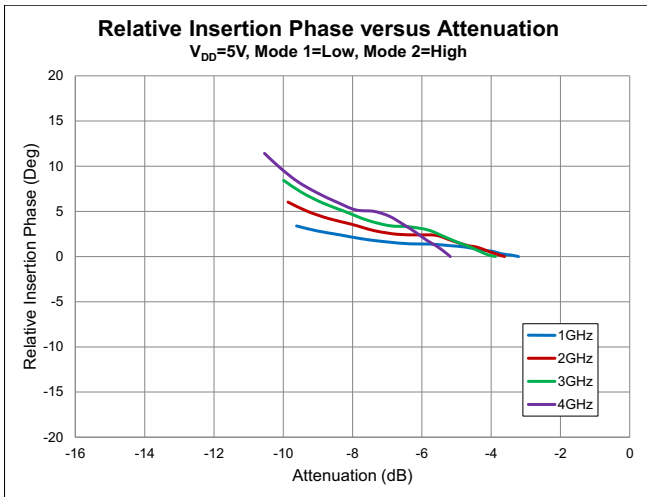
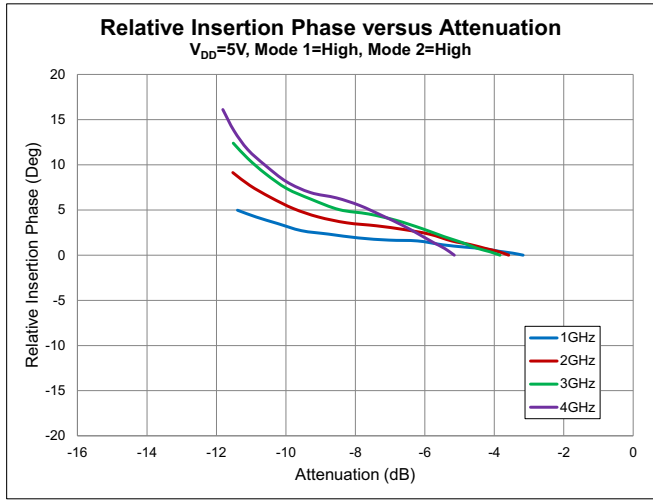
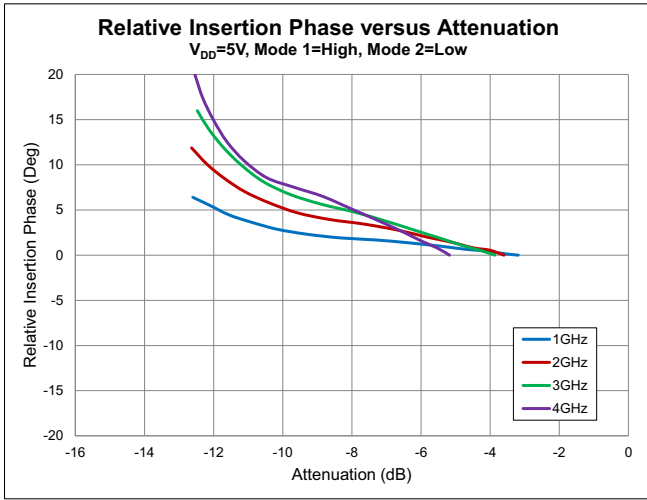

Measured at 6GHz Performance

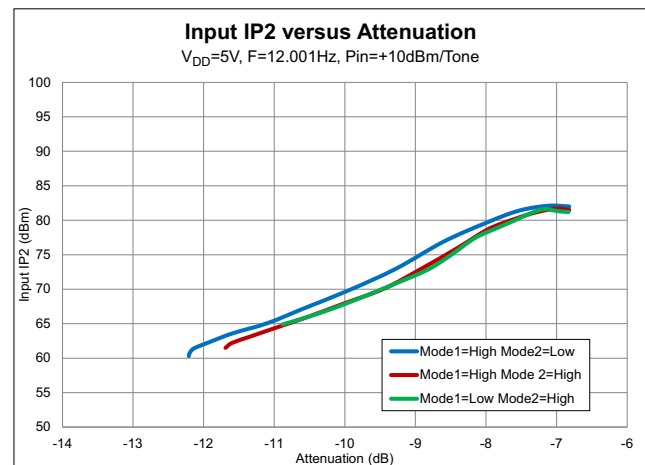
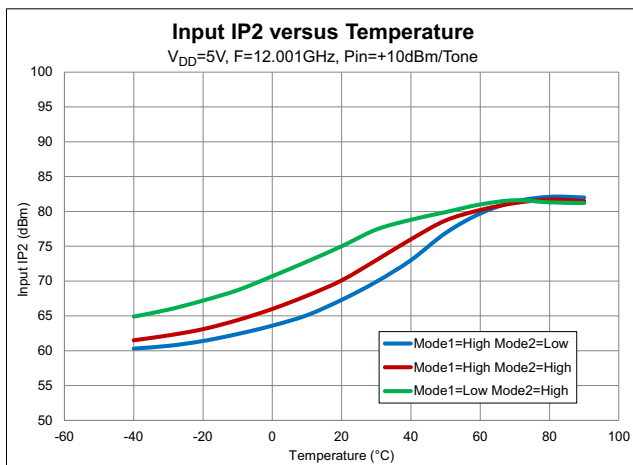
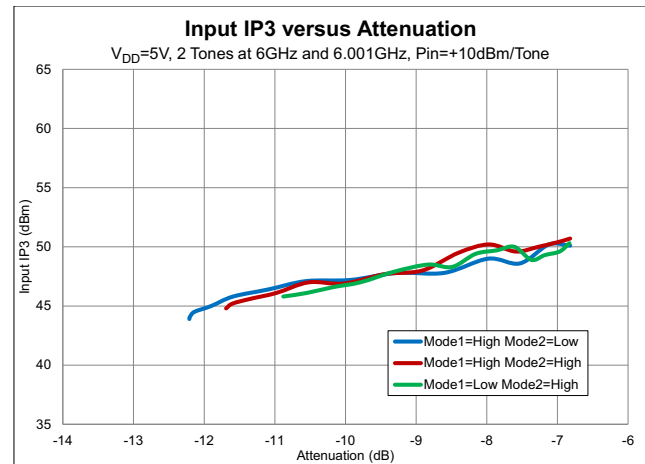
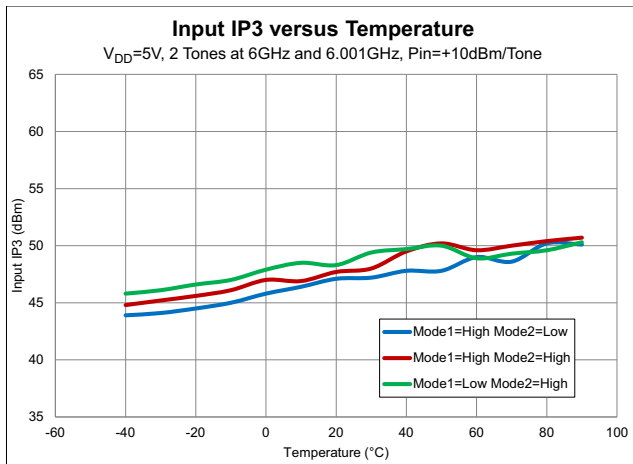

Measured at 6GHz Performance

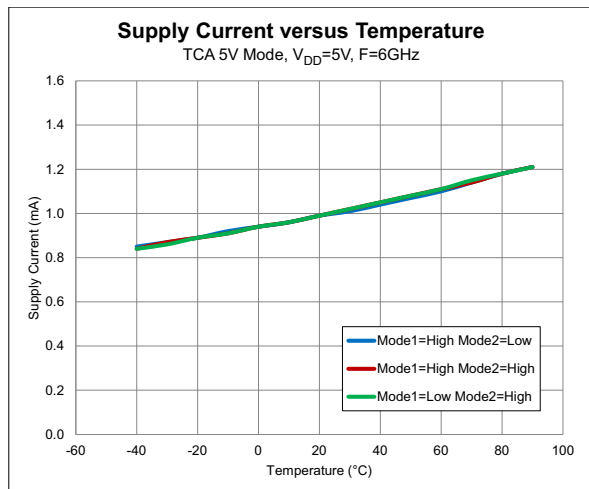
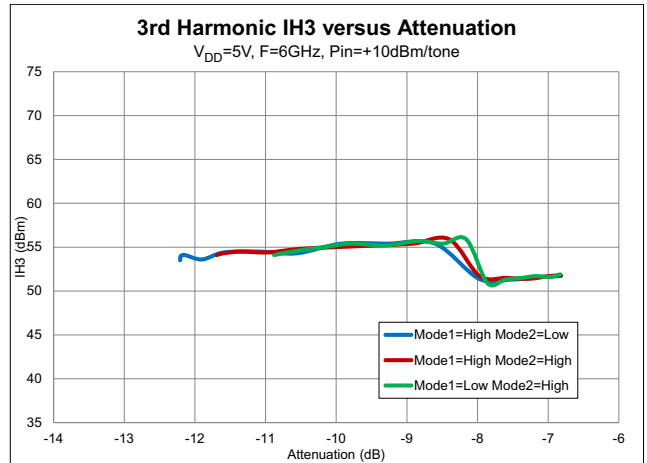
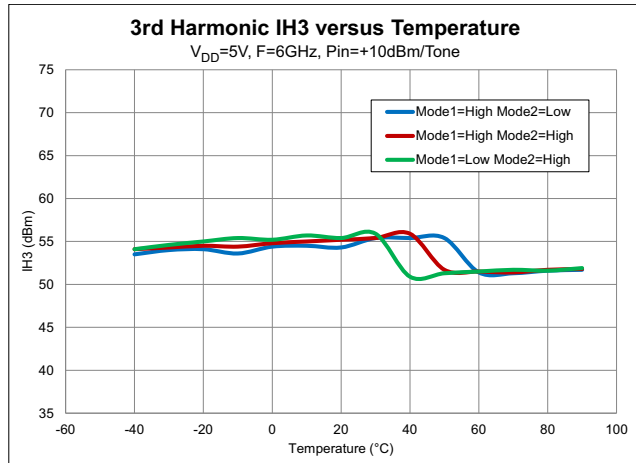
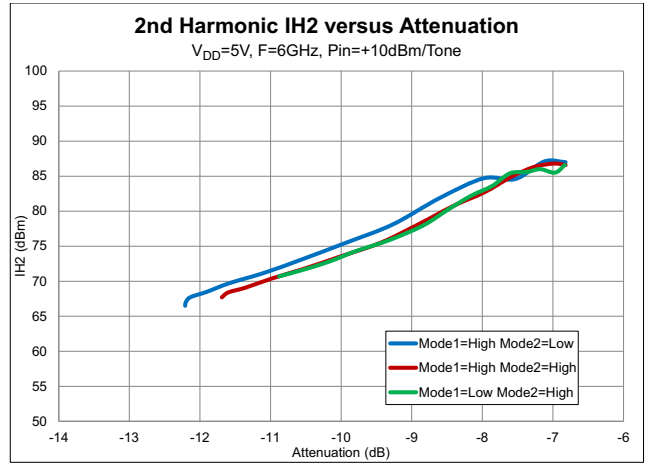
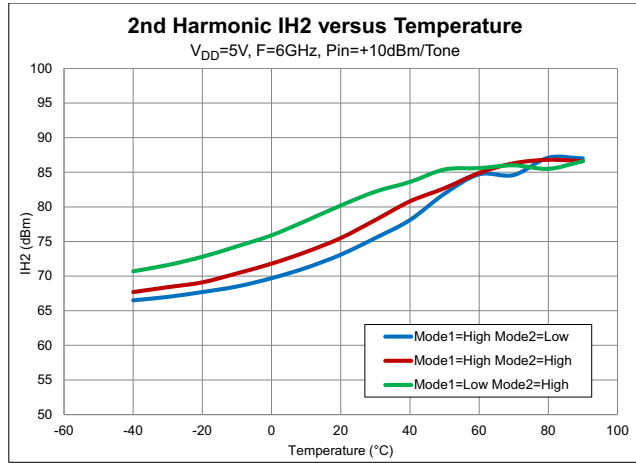

Pin Names and Description

Pin	Name	Description
1	GND	Ground Pin
2	NC	No Connection. Do not Connect to PC Board Ground Plane.
3	RFIN	RF Input. Use External DC Block.
4	NC	No Connection. Do not Connect to PC Board Ground Plane.
5	GND	Ground Pin
6	MODE1	Logic Input for Slope Selection. See Table for Options.
7	MODE2	Logic Input for Slope Selection. See Table for Options.
8	GND	Ground Pin
9	NC	No Connection. Do not Connect to PC Board Ground Plane.
10	RFOUT	RF Output. Use External DC Block.
11	NC	No Connection. Do not Connect to PC Board Ground Plane.
12	GND	Ground Pin
13	GND	Ground Pin
14	GND	Ground Pin
15	VDD	Supply Voltage (5V)
16	GND	Ground Pin
GND	GND	Exposed Package Ground Paddle is RF and DC Ground

Mode Selection Table

Mode1	Mode2	Slope dB/°C	25° C Atten (dB)
LOW	HIGH	0.043	5.4
HIGH	HIGH	0.058	6.35
HIGH	LOW	0.066	7.4

Evaluation Board Schematic

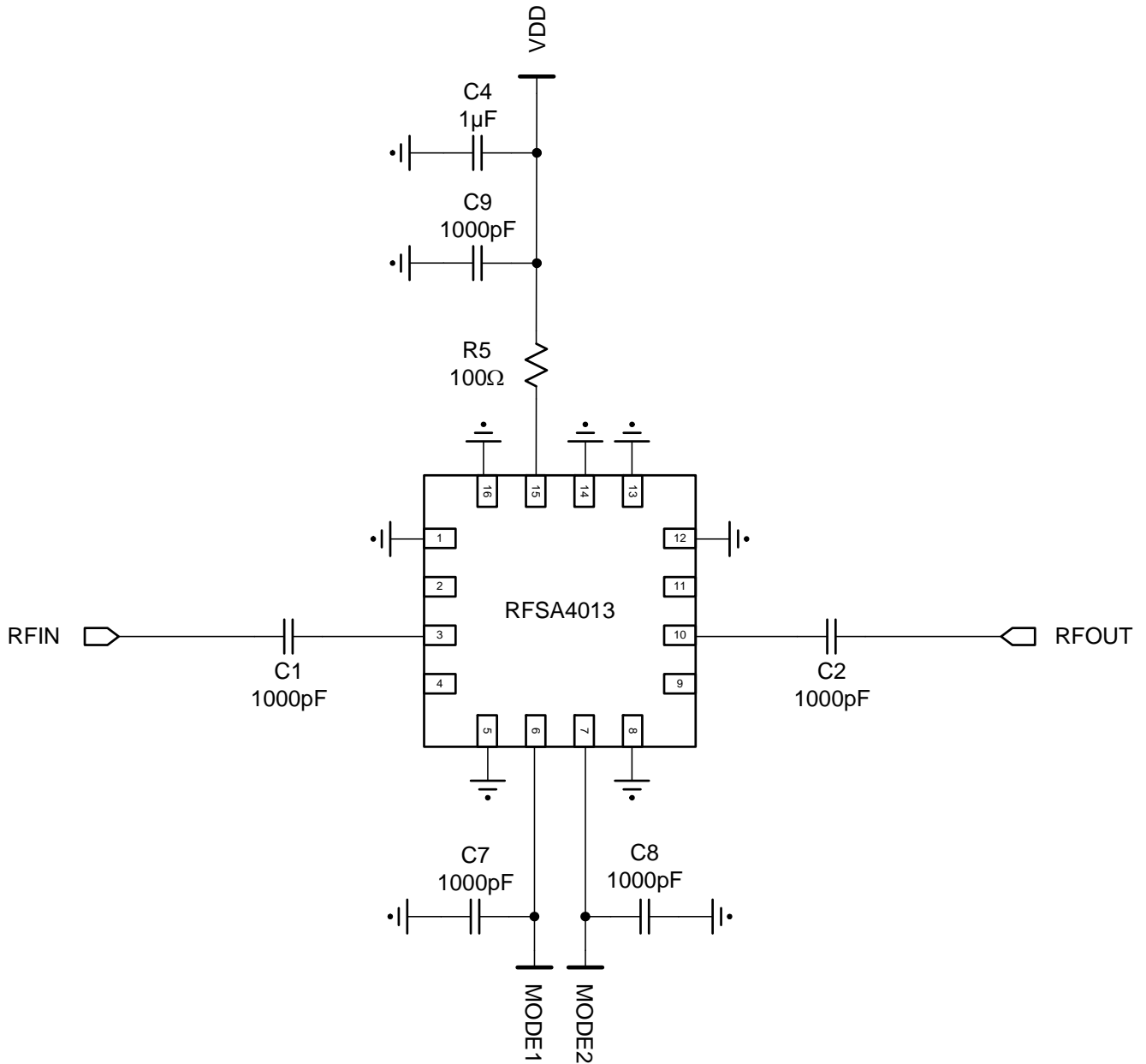

Evaluation Board Assembly Drawing

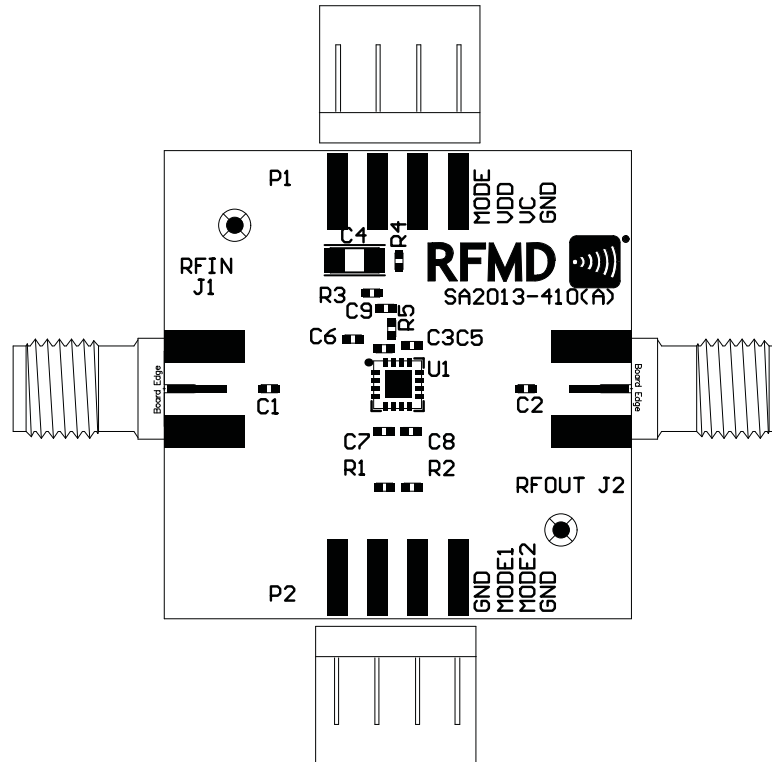

Evaluation Board Build of Materials (BOM)

Description	Reference Designator	Manufacturer	Manufacturer's P/N
Temperature Compensating Attenuator TCA, 5V	U1	RFMD	RFSA4013
CONN, SMA, END LNCH, MINI, FLT, 0.068"	J1-J2	Emerson Network Power	142-0741-851
CONN, HDR, ST, 4-PIN, 0.100", T/H	P1-P2	MOLEX	22-28-4043
PCB, SA2013-410		DDI	SA2013-410(A)
CAP, 1000pF, 10%, 25V, X7R, 0402	C1, C2, C7-C9	Murata Electronics	GRM155R71H102KA01D
CAP, 1μF, 10%, 16V, X7R, 1206	C4	Murata Electronics	GRM31MR71E105KC01L
RES, 100Ω, 5%, 1/16W, 0402	R5	Kamaya, Inc	RMC1/16S-101JTH
DNP	C3, C5-C6	N/A	N/A
DNP	R1-R4	N/A	N/A

Package Drawing
(0.9mm x 3mm x 3mm)

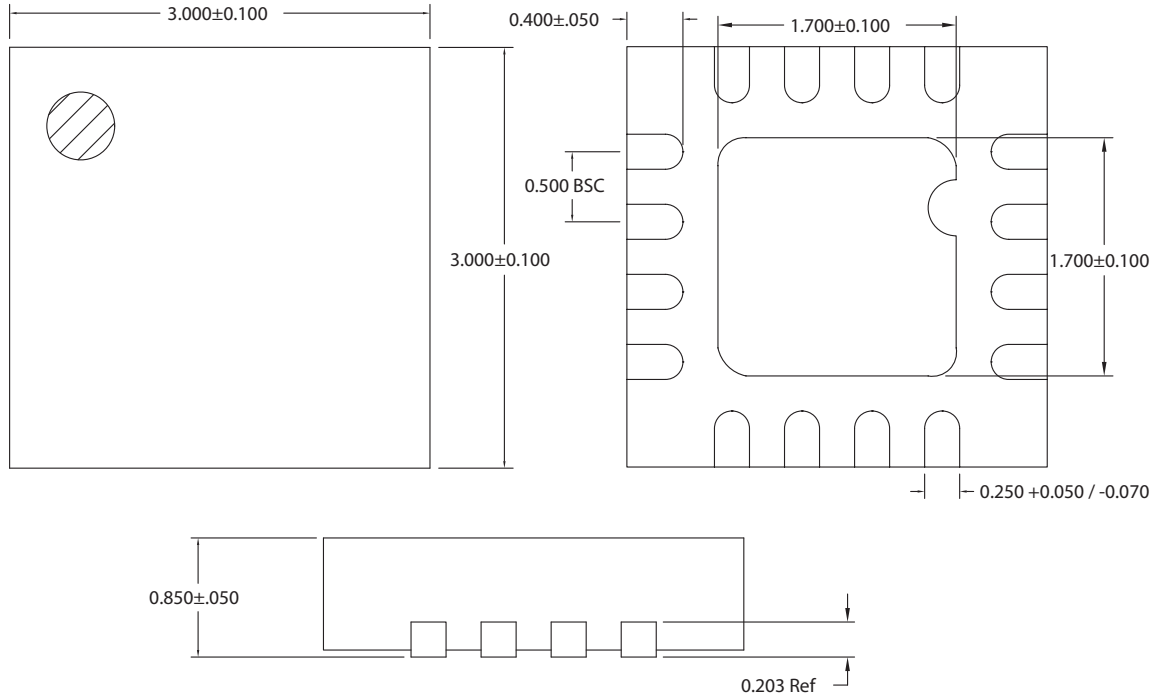

Branding Diagram
(0.9mm x 3mm x 3mm)

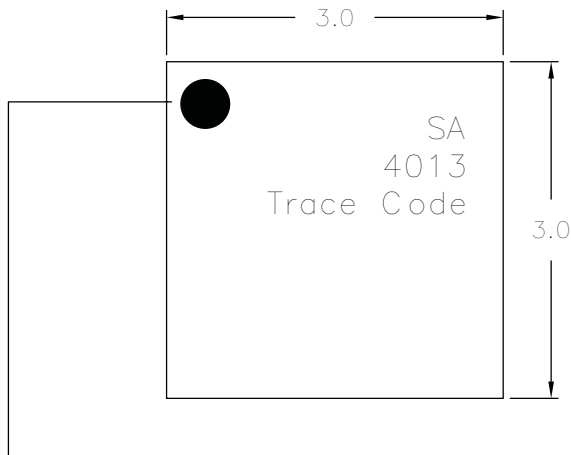

Pin 1 Indicator

Trace Code to be assigned by SubCon

PCB Patterns

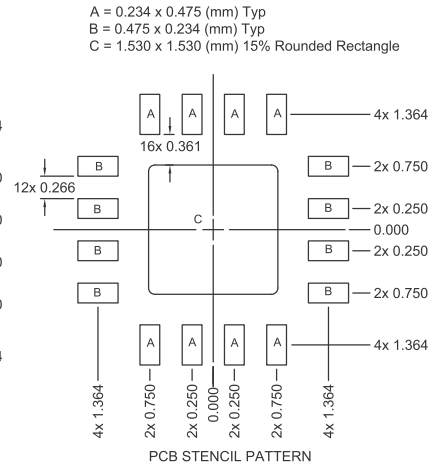
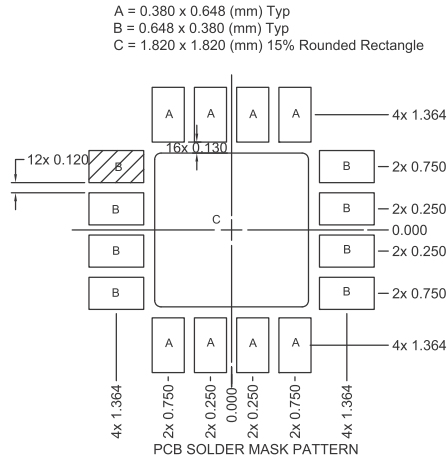
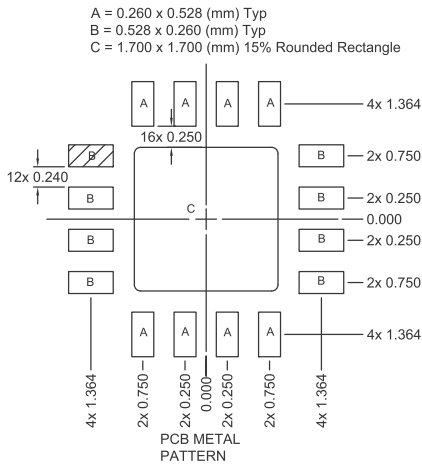

Thermal vias for center slug "C" should be incorporated into the PCB design. The number and size of thermal vias will depend on the application, the power dissipation, and the electrical requirements. Example of the number and size of vias can be found on the RFMD evaluation board layout.

Shaded are represents Pin 1 location.

X-ON Electronics

Largest Supplier of Electrical and Electronic Components

Click to view similar products for [Attenuators](#) category:

Click to view products by [Qorvo](#) manufacturer:

Other Similar products are found below :

[ATN3580-01](#) [HMC305SLP4ETR](#) [MAAD-009195-000100](#) [TGL4201-00](#) [TGL4201-02](#) [TGL4201-03](#) [TGL4201-06](#) [TGL4201-10](#) [ATN3590-15](#) [20-50TPC](#) [D10AA5Z4](#) [18AH-01](#) [18AH-08](#) [ATN3580-20](#) [ATN3590-09](#) [20-50RP](#) [MASW-008322-000000](#) [PCAF-10](#) [EXB-24AT9AR5X](#) [ATN3580-10](#) [HMC539ALP3ETR](#) [ATN3580-02](#) [WA04P006XCTL](#) [SKY12408-321LF](#) [ATN3580-03](#) [WA04P005XBTL](#) [HMC-VVD104-SX](#) [WA04P007XCTL](#) [SKY12236-11](#) [MAATSS0018TR-3000](#) [HMC656-SX](#) [WA04P001XBTL](#) [MAAV-007941-TR3000](#) [WA04P004XBTL](#) [WA04P002XBTL](#) [HMC941A](#) [PAT0816-C-0DB-T5](#) [PAT0816-C-8DB-T5](#) [PAT0816-C-10DB-T5](#) [PAT1632-C-3DB-T1](#) [PAT1632-C-6DB-T1](#) [PAT1632-C-10DB-T1](#) [PAT1632-C-1DB-T1](#) [PAT0816-C-2DB-T5](#) [PAT0816-C-4DB-T5](#) [DHM510-0100-006](#) [MAT10300](#) [MAT10180](#) [MAATCC0007-TB](#) [MAATCC0011](#)