

RFSA4033

Programmable Temperature Compensating Attenuator 5MHz to 6000MHz

The RFSA4033 is a fully monolithic linear-in-dB analog temperature compensating attenuator (TCA) featuring exceptional linearity over its entire gain control range. It is designed to offset the gain reduction of an RF component over temperature without the need for closed loop feedback. Eight customer selectable scaled attenuation slopes and eight selectable nominal attenuation values at 25°C creates a total combination of 64 possible temperature coefficients which make it a flexible solution for RF lineups. It incorporates revolutionary new circuit architecture to solve a long standing industry problem with regards to attenuator architecture: high IP3, low DC current and broad bandwidth. Traditional approaches for solving this problem require expensive co-fired ceramics with temperature sensitive materials or current hungry PIN diodes with elaborate area consuming control circuits. This temperature compensating attenuator requires only a single supply voltage and 6 logic bits to set the temperature coefficient. The RFSA4033 is packaged in a small 3mm x 3mm QFN. This attenuator is matched to 50Ω over its rated control range and frequency with no external matching components required.



Package: QFN, 16-pin,
3.0mm x 3.0mm x 0.85mm

Features

- Patented Circuit Architecture
- Broadband 5MHz to 6000MHz Frequency Range
- 64 Selectable Attenuation versus Temperature Linear-in-dB Slopes
- +52dBm Input IP3 Typical
- +80dBm Input IP2 Typical
- High 1dB Compression Point >+30dBm
- Low Residual Phase Noise <-140dBc/Hz at 10kHz offset
- 3V to 5V Power Supply
- 3V Logic Compatible
- Class 2 ESD (2000V HBM)

Applications

- Cellular, 3G, LTE Infrastructure
- WiBro, LTE
- Microwave Radio
- High Linearity RF Power Control
- Cable Modems
- CATV
- Test Equipment

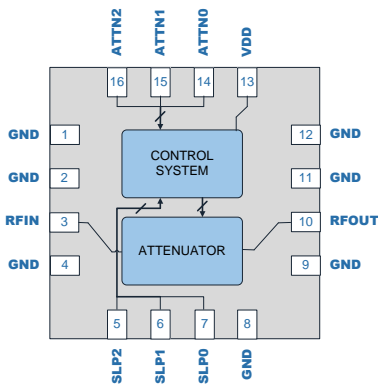

Functional Block Diagram

Ordering Information

RFSA4033SQ	Sample bag with 25 pieces
RFSA4033SR	7" Reel with 100 pieces
RFSA4033TR7	7" Reel with 2500 pieces
RFSA4033PCK-410	5MHz to 6GHz PCBA with 5-piece sample bag

RFSA4033

Absolute Maximum Ratings

Parameter	Rating	Unit
Supply Voltage (V_{DD})	-0.5 to 6.0	V
Logic Control Voltage	-0.5 to V_{DD}	V
Maximum CW Input Power	30	dBm
Storage Temperature Range	-65 to +150	°C
ESD Rating - Human Body Model (HBM)	2000	V
Moisture Sensitivity Level	MSL2	



Caution! ESD sensitive device.



RFMD Green: RoHS status based on EU Directive 2011/65/EU (at time of this document revision), halogen free per IEC 61249-2-21, < 1000ppm each of antimony trioxide in polymeric materials and red phosphorus as a flame retardant, and <2% antimony in solder.

Exceeding any one or a combination of the Absolute Maximum Rating conditions may cause permanent damage to the device. Extended application of Absolute Maximum Rating conditions to the device may reduce device reliability. Specified typical performance or functional operation of the device under Absolute Maximum Rating conditions is not implied.

Recommended Operating Condition

Parameter	Specification			Unit
	Min	Typ	Max	
Operating Temperature Range	-40		+105	°C
Operating Junction Temperature			+125	°C
Supply Voltage (V_{DD})	3.0		5.5	V

Nominal Operating Parameters

Parameter	Specification			Unit	Condition
	Min	Typ	Max		
Supply and Interface Requirements					
Supply Current (I_{DD})		7	10	mA	
Attenuation Bits (ATTN)		3			8 Nominal insertion loss states at 25°C
Slope Bits (SLP)		3			8 (Insertion loss versus temperature) slope states
Control Pins Logic Low			0.8	V	
Control Pins Logic High	2.0			V	
Thermal Resistance		45		°C/W	
RF Input Power			27	dBm	
Typical Performance: $V_{DD} = 5V$, Temp = 25°C, RF Frequency = 2000MHz					
Frequency Range	5		6000	MHz	
Nominal Attenuation	3		10	dB	At +25°C, selectable in 1dB steps
Nominal Attenuation Accuracy (See Table Below)	See Table			dB	At +25°C
Relative Temperature Coefficient	3		10	mdB/°C/ATTN	Selectable in 1mdB/°C/ATTN increments where ATTN is the Nominal Attenuation setting

RFSA4033

Parameter	Specification			Unit	Condition
	Min	Typ	Max		
General Performance - Continued					Typical Performance: $V_{DD} = 5V$, Temp = 25°C, RF Frequency = 2000MHz
Relative Temperature Coefficient Accuracy		±1		mdB/°C/ATTN	where ATTN is the Nominal Attenuation setting
Nominal Impedance		50		Ω	
Input Return Loss		18		dB	
Output Return Loss		18		dB	
Input P1dB		30		dBm	
Input IP2		80		dBm	F1 + F2 input intercept point, Pin + (POUT – IM2)
Input IP3	45	52		dBm	
Input IH2		86		dBm	2F input intercept point, Pin + (POUT – F2)
Input IH3		58		dBm	3F input intercept point, Pin + (POUT – F3) /2

Nominal Attenuation Accuracy Table

Nominal Attenuation Accuracy	Typical	Unit
3	2.7	dB
4	3.6	dB
5	4.6	dB
6	5.7	dB
7	6.8	dB
8	7.9	dB
9	9.0	dB
10	10.1	dB

Nominal Attenuation Truth Table

ATTN2	ATTN1	ATTN0	S ₂₁ ATTN Value at 25°C (dB)
0	0	0	3
0	0	1	4
0	1	0	5
0	1	1	6
1	0	0	7
1	0	1	8
1	1	0	9
1	1	1	10

RFSA4033

Relative Temperature Coefficient Truth Table

SLP2	SLP1	SLP0	S ₂₁ Temperature Coefficient (mdB/°C/Attn)
0	0	0	3
0	0	1	4
0	1	0	5
0	1	1	6
1	0	0	7
1	0	1	8
1	1	0	9
1	1	1	10

Absolute temperature coefficient is dependent on the nominal attenuation setting and can be calculated as *Nominal Attenuation x Relative Temperature Coefficient*.

Example:

For an attenuation setting of ATTN[2:0] = 1 0 0 (7dB) and a relative temperature coefficient setting of SLP[2:0] = 1 1 0 (9mdB/°C/attn.), the absolute temperature coefficient would be 7dB x 9mdB/°C/Attn = 63mdB/°C

The maximum and minimum temperature coefficients would be calculated as:

$$3\text{dB} \times 3 \text{ mdB/}^\circ\text{C/Attn} = 9 \text{ mdB/}^\circ\text{C}$$

And

$$10\text{dB} \times 10 \text{ mdB/}^\circ\text{C/Attn} = 100 \text{ mdB/}^\circ\text{C}$$

RFSA4033

Typical Application Schematic

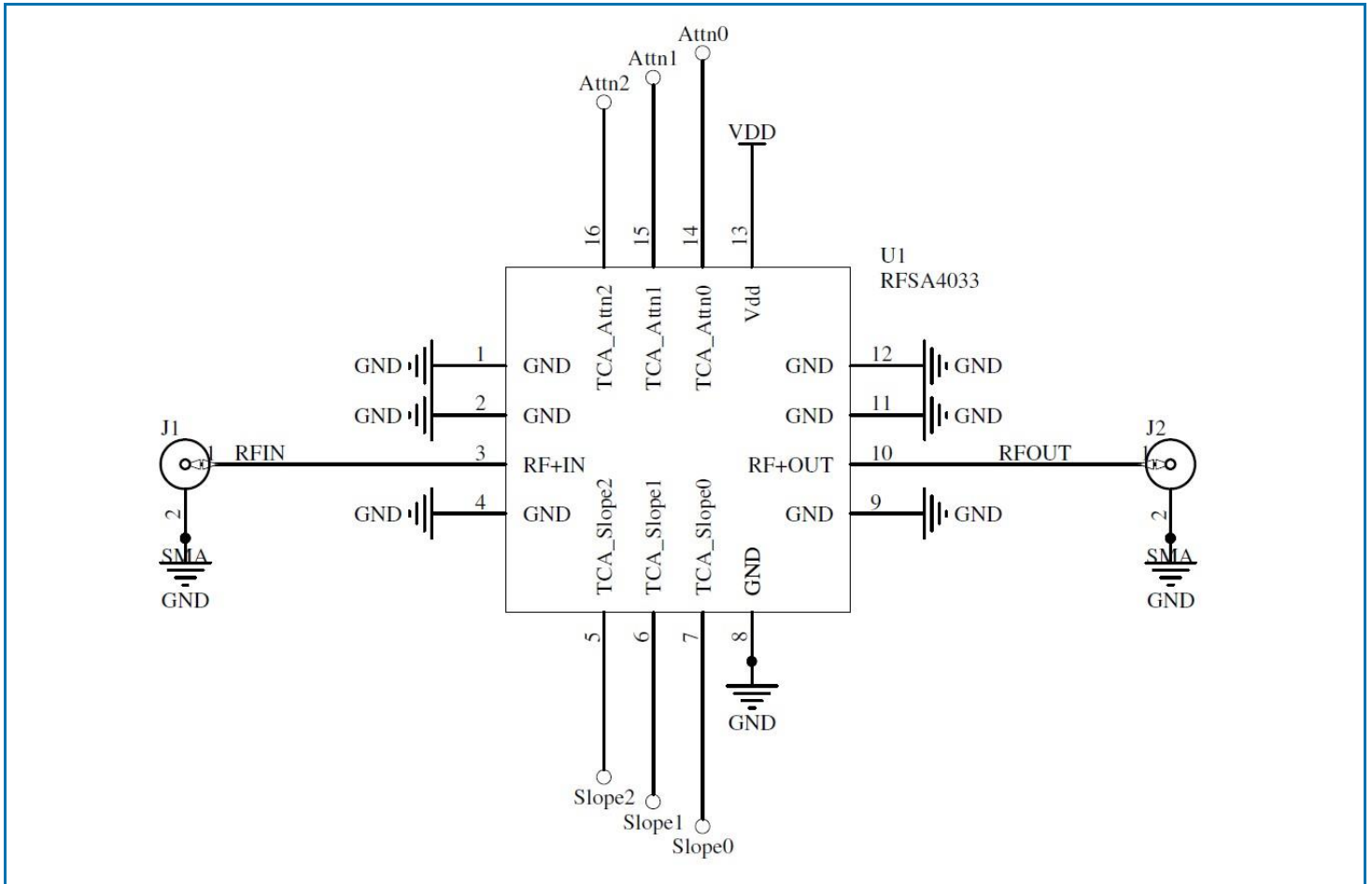

RFSA4033

Typical Performance: T = 25°C, V_{DD} = 5V unless otherwise noted

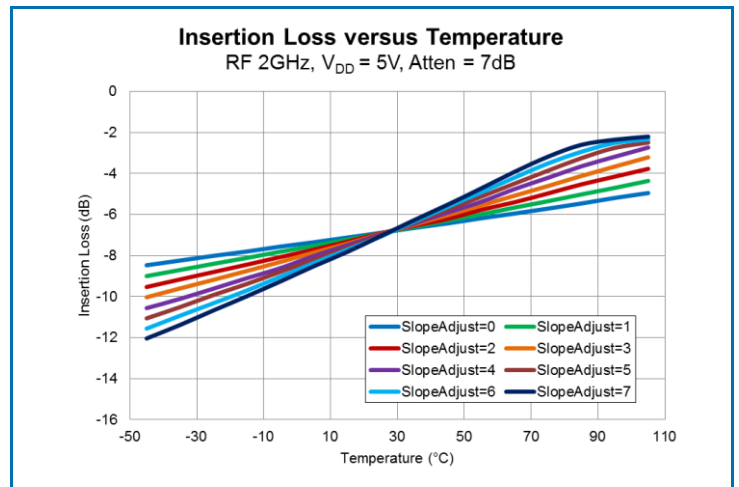
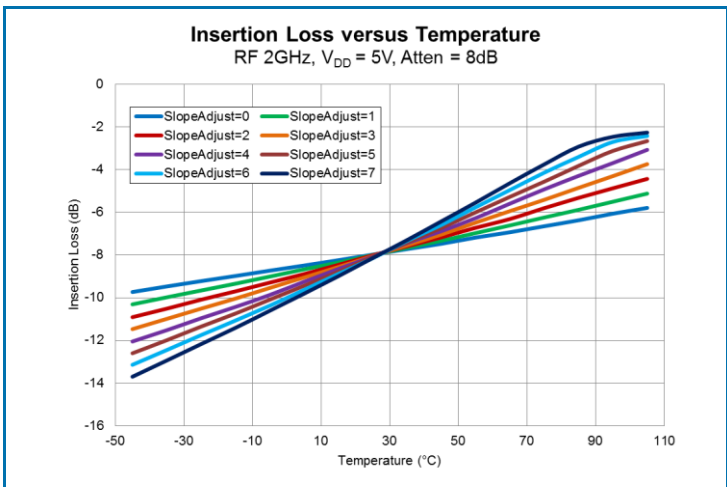
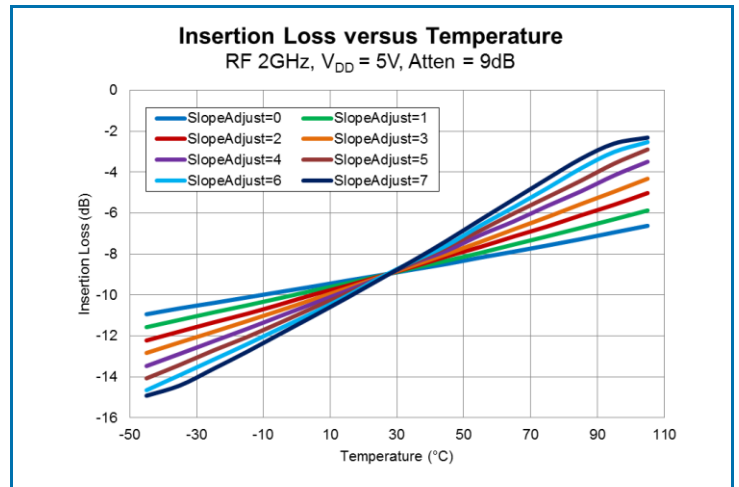
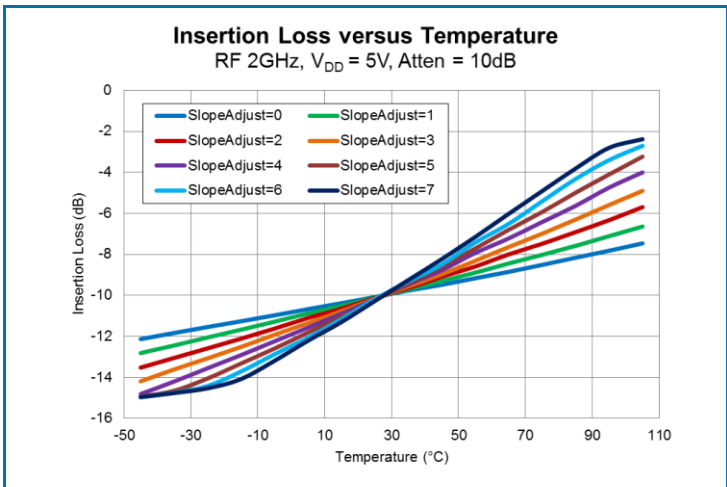
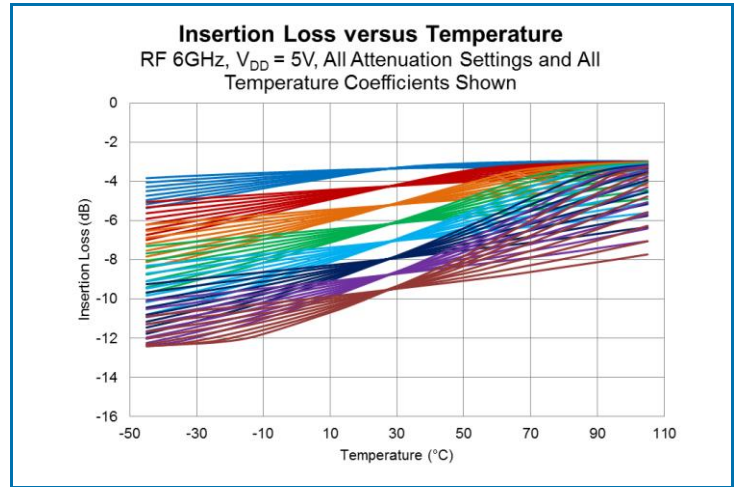
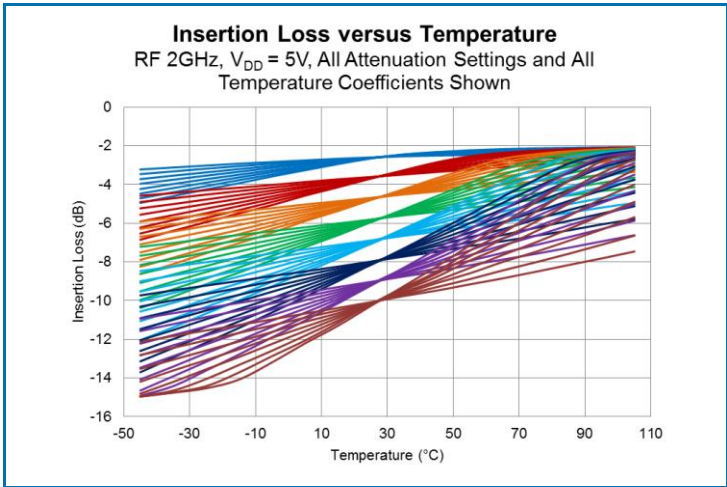

RFSA4033

Typical Performance: T = 25°C, V_{DD} = 5V unless otherwise noted

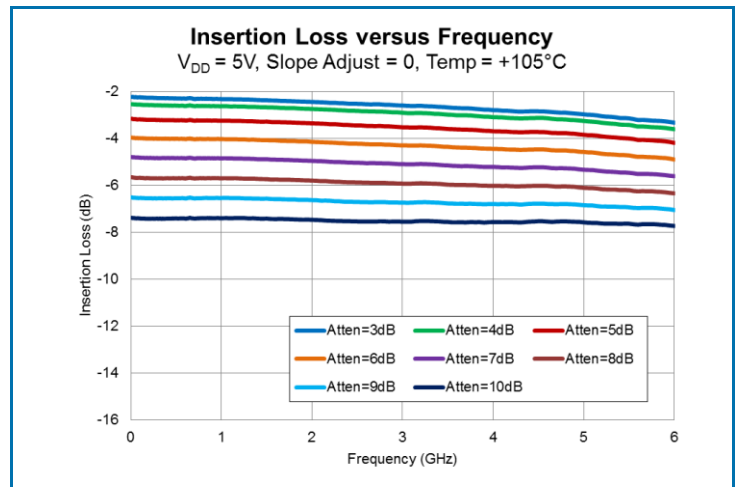
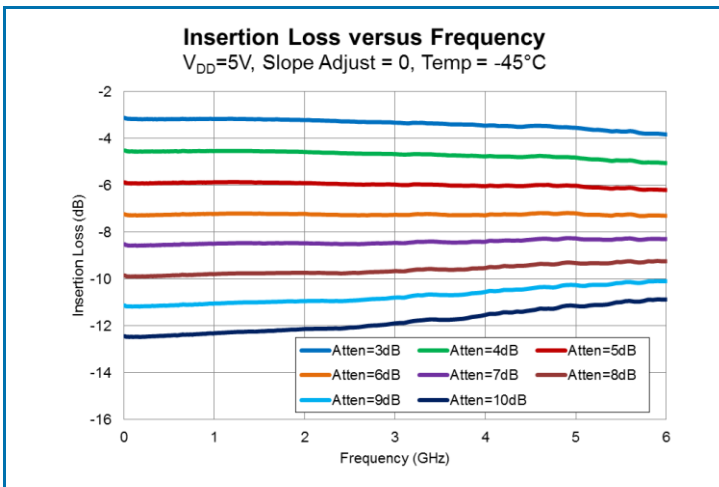
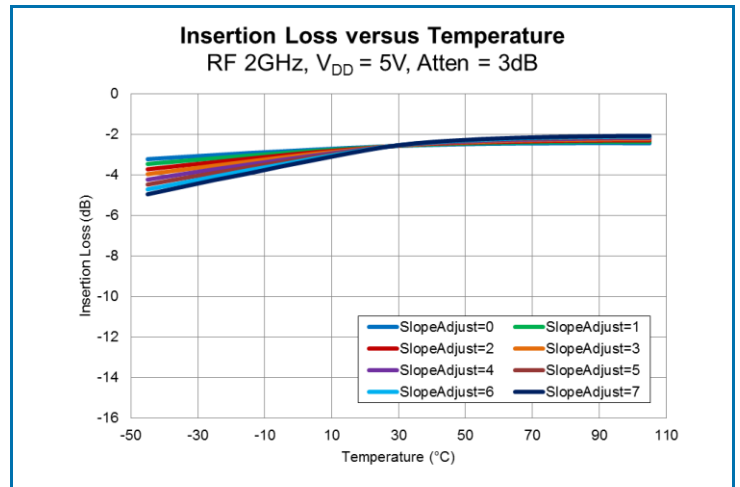
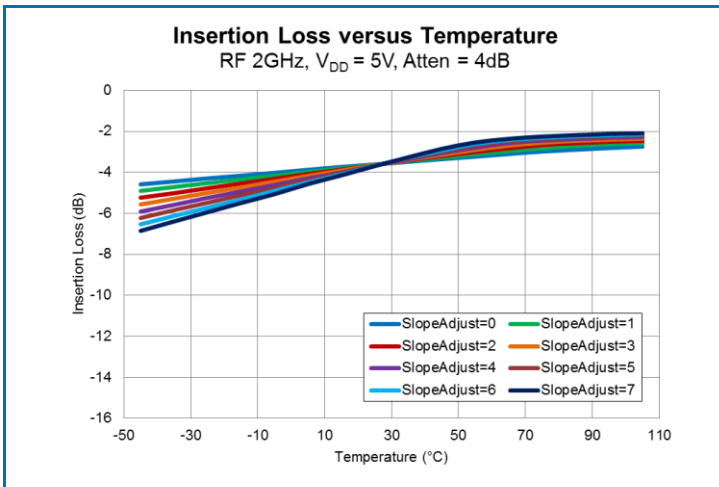
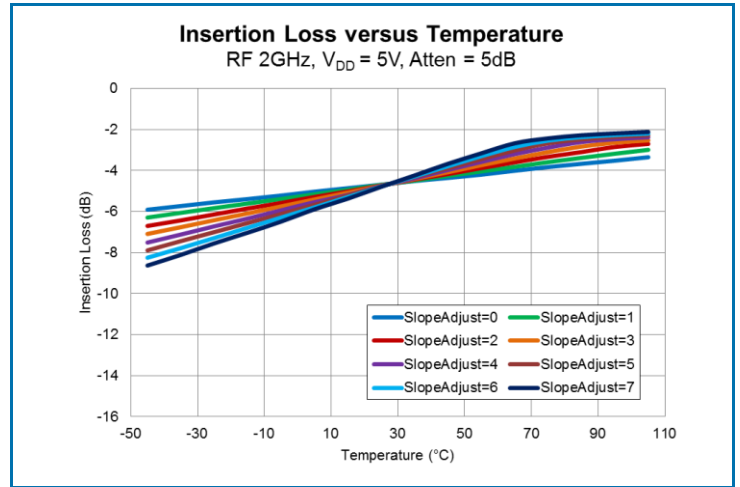
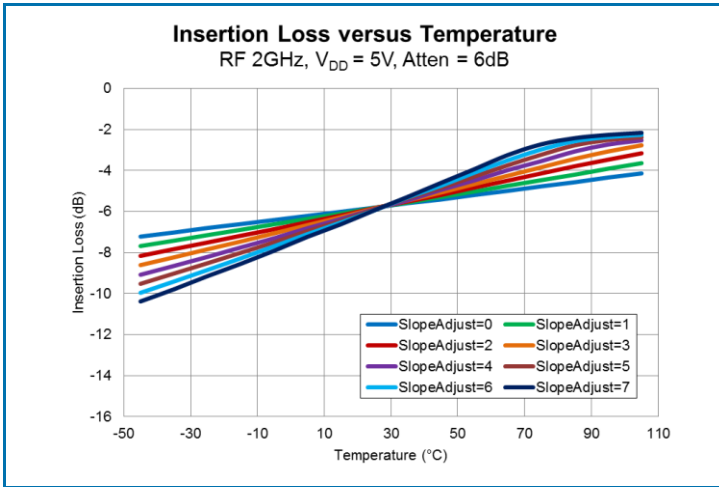

RFSA4033

Typical Performance: T = 25°C, V_{DD} = 5V unless otherwise noted

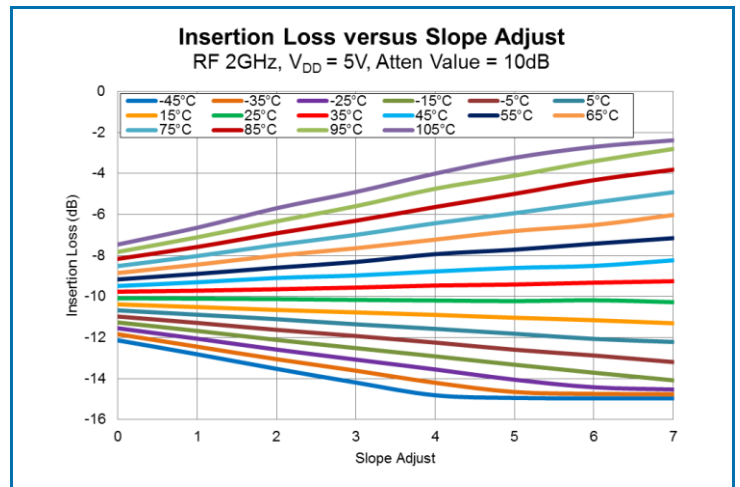
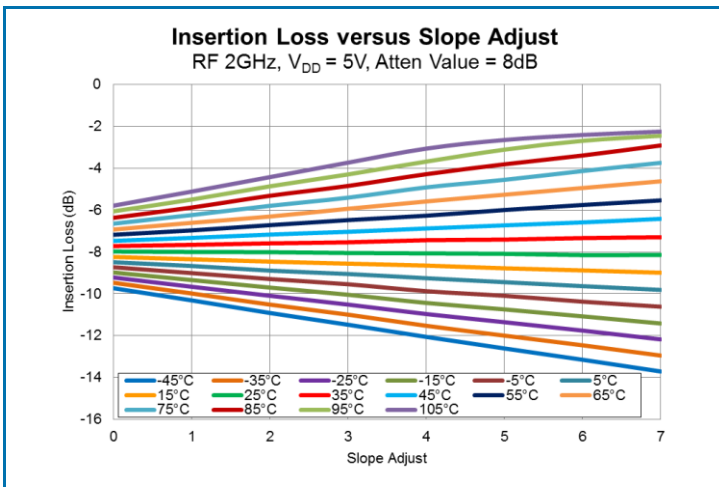
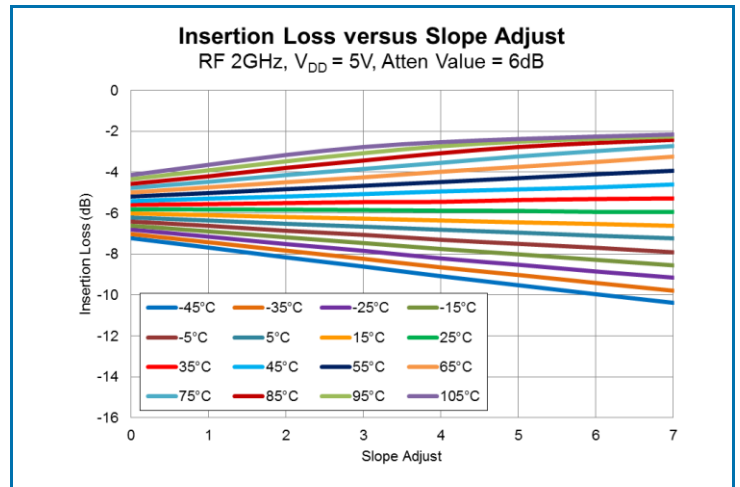
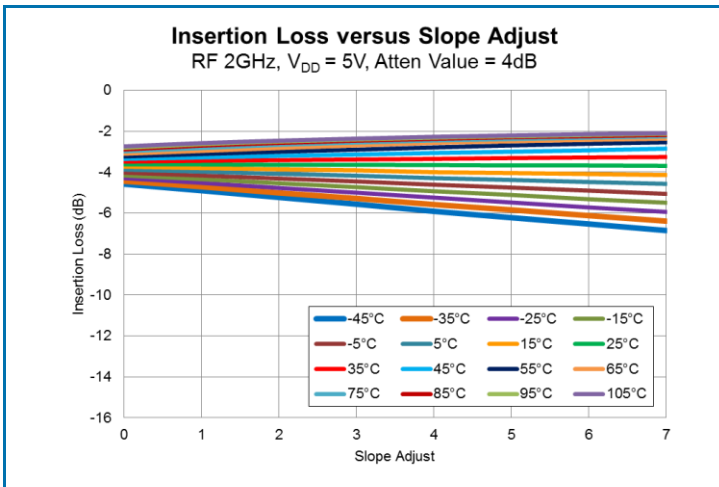
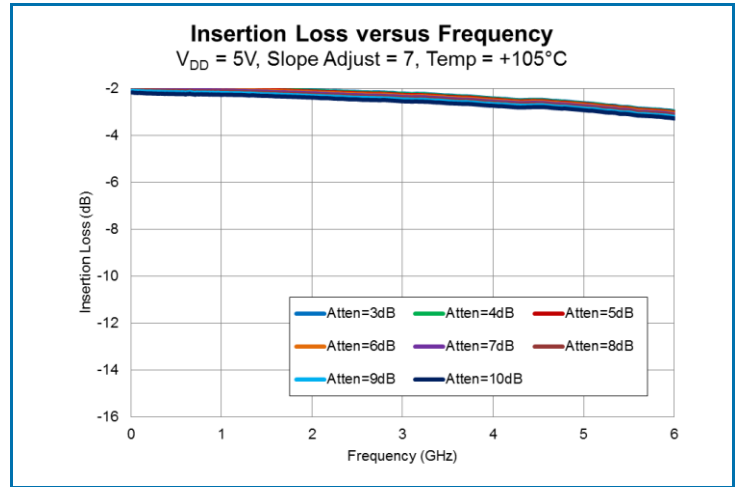
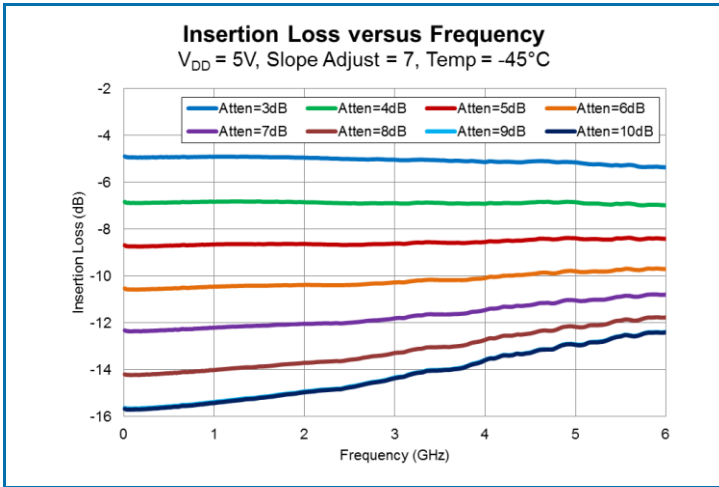

RFSA4033

Typical Performance: T = 25°C, V_{DD} = 5V unless otherwise noted

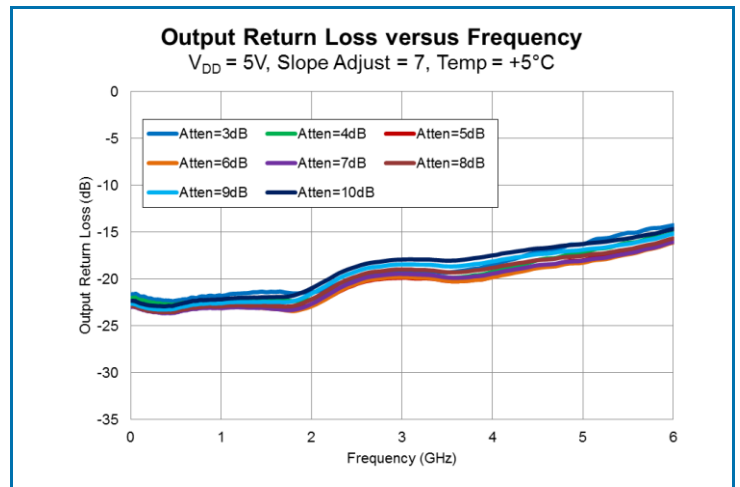
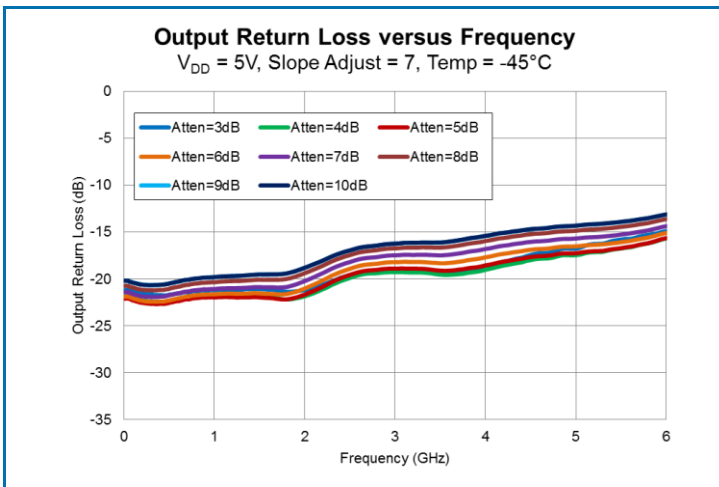
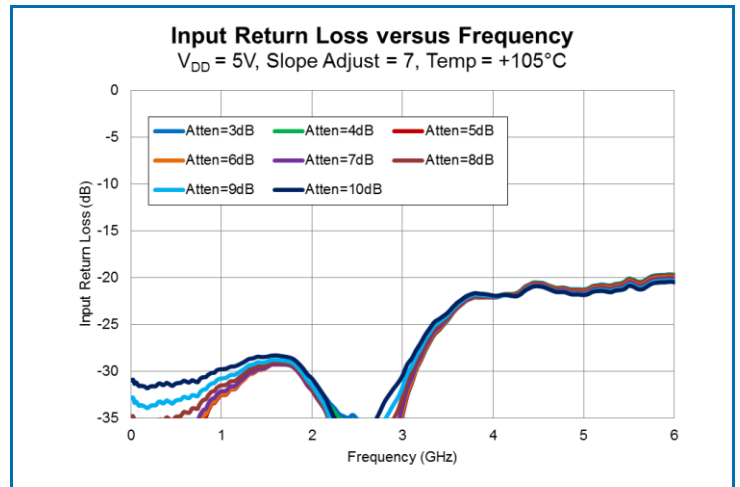
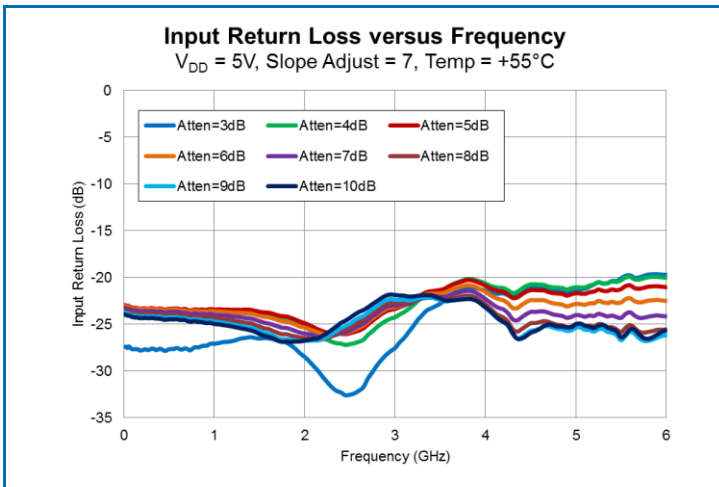
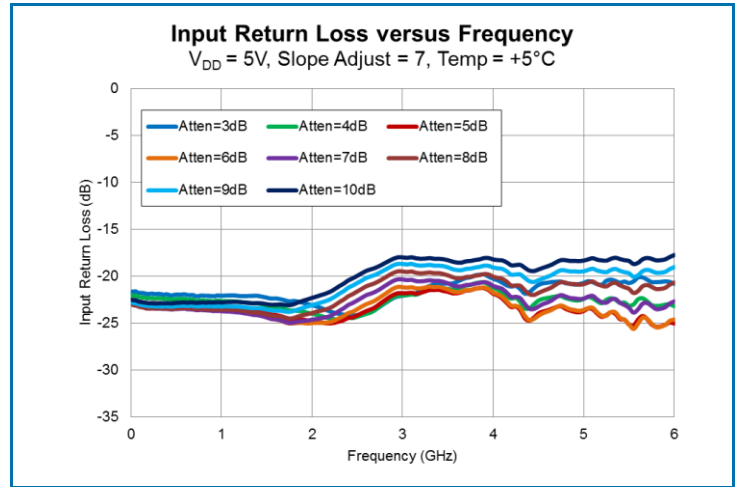
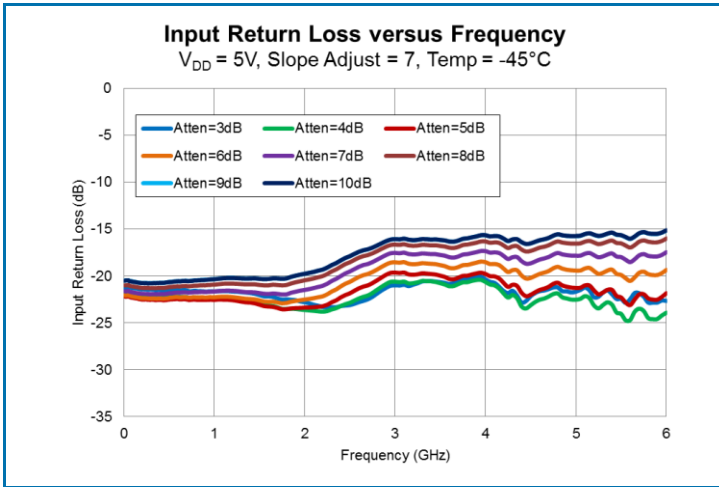

RFSA4033

Typical Performance: T = 25°C, V_{DD} = 5V unless otherwise noted

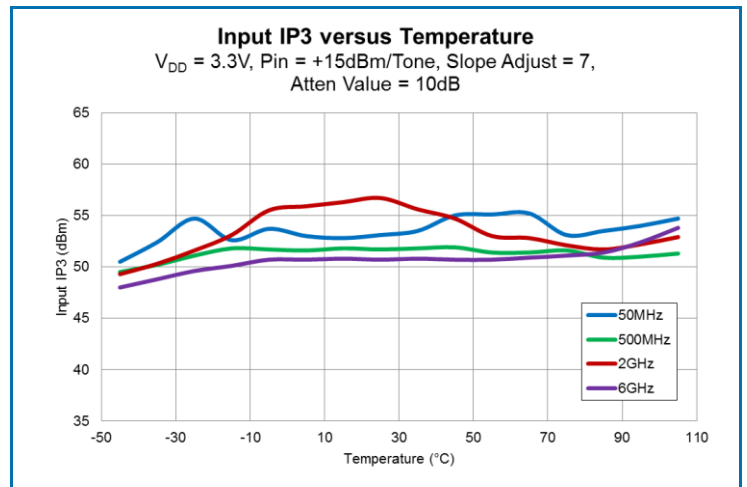
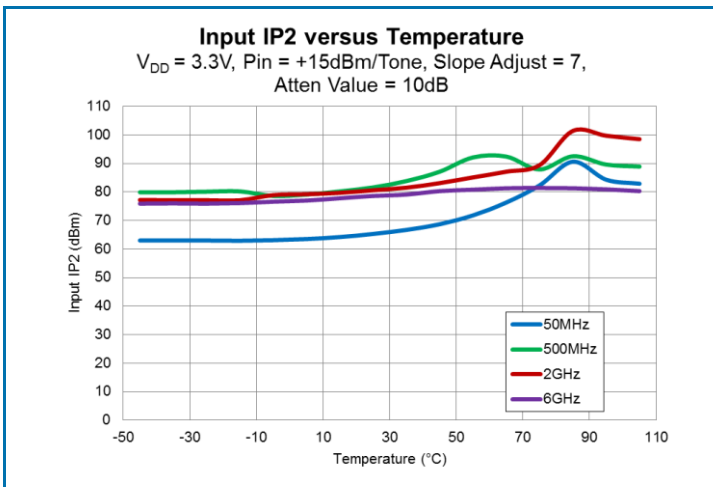
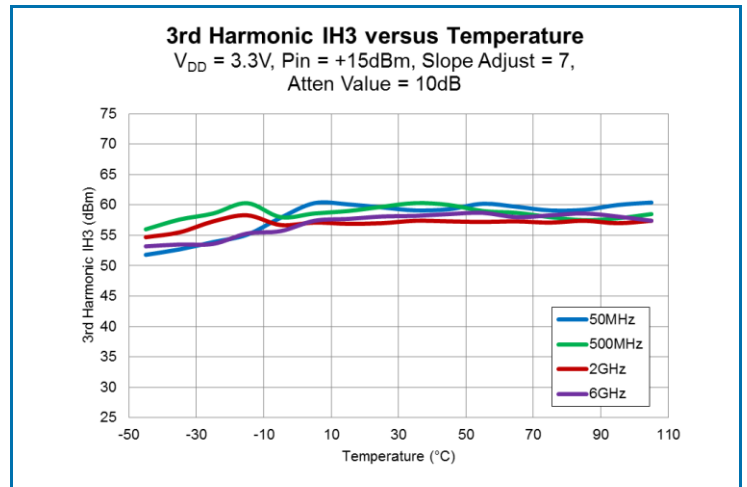
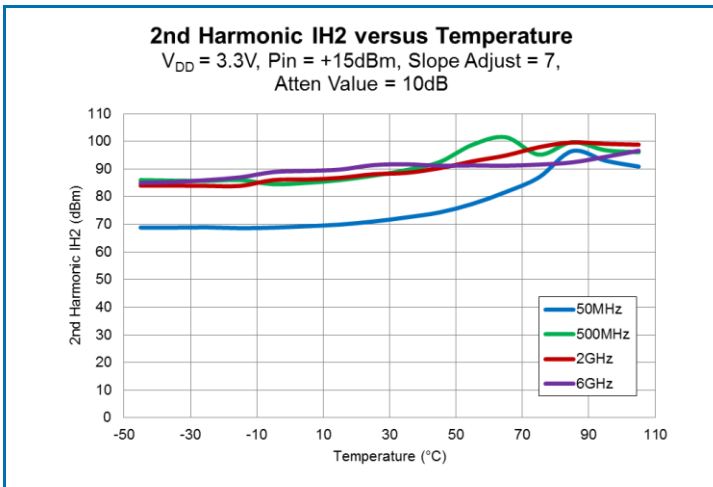
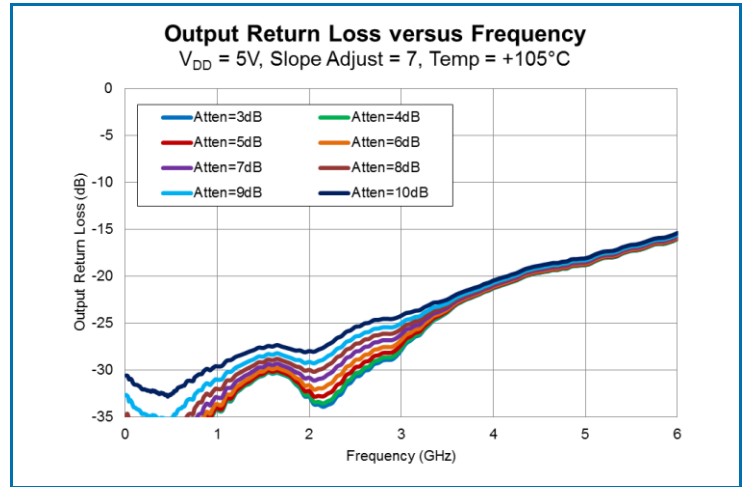
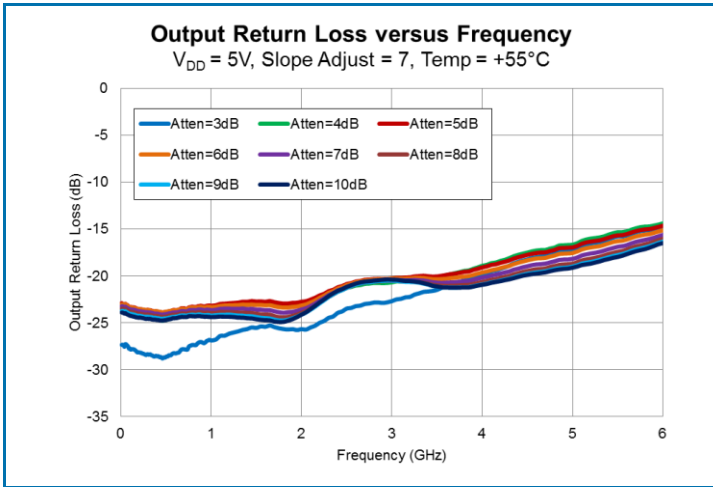

RFSA4033

Typical Performance: T = 25°C, V_{DD} = 5V unless otherwise noted

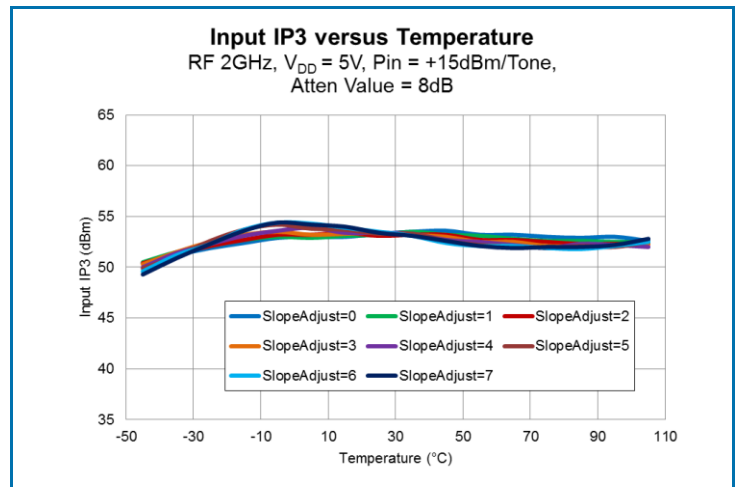
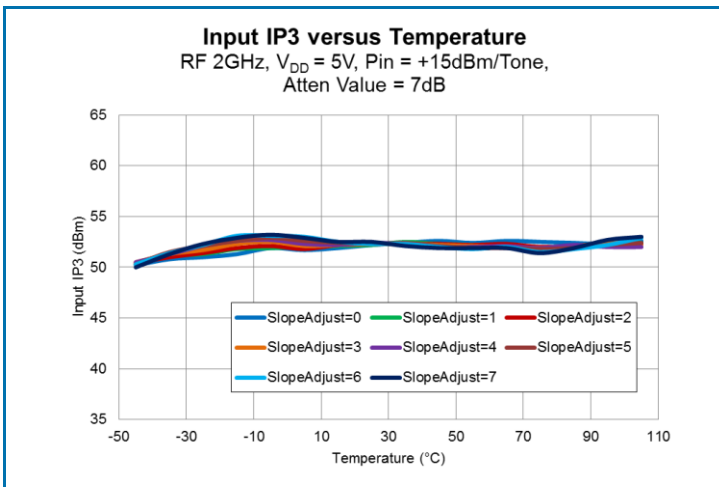
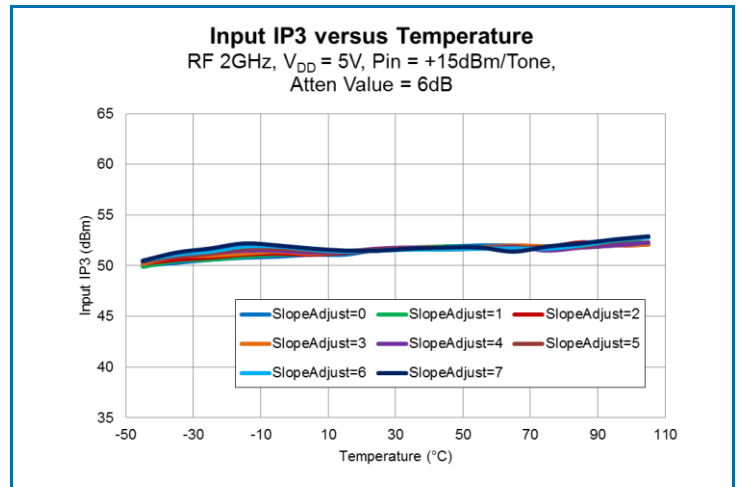
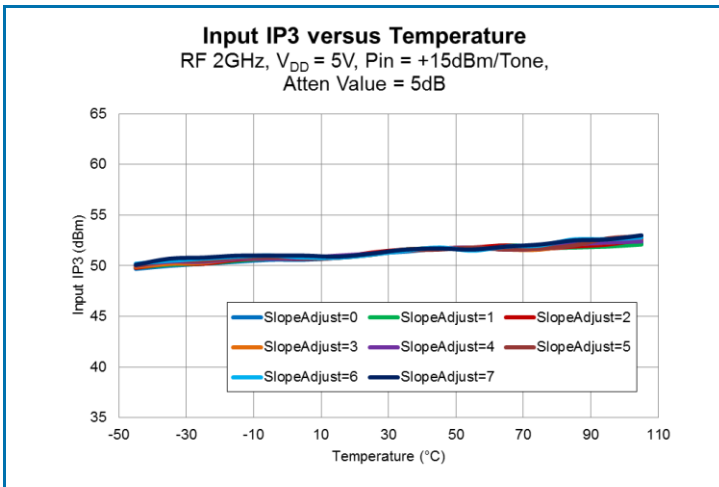
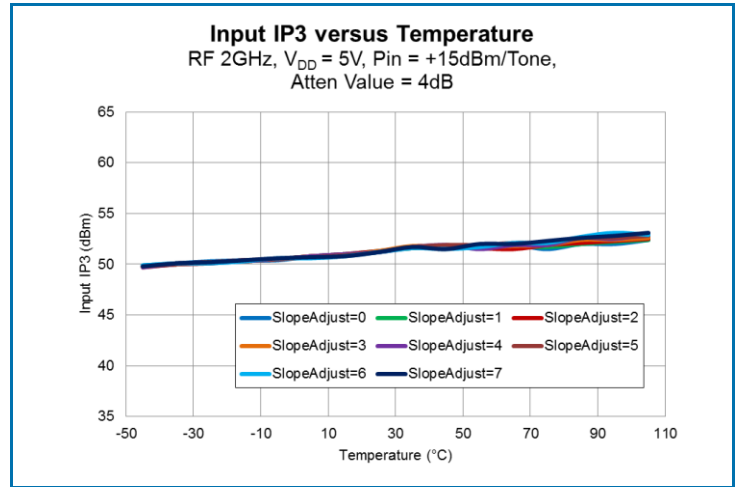
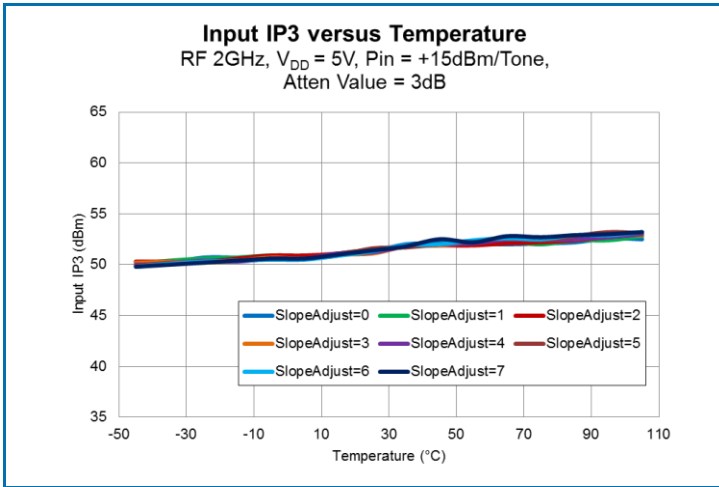

RFSA4033

Typical Performance: T = 25°C, V_{DD} = 5V unless otherwise noted

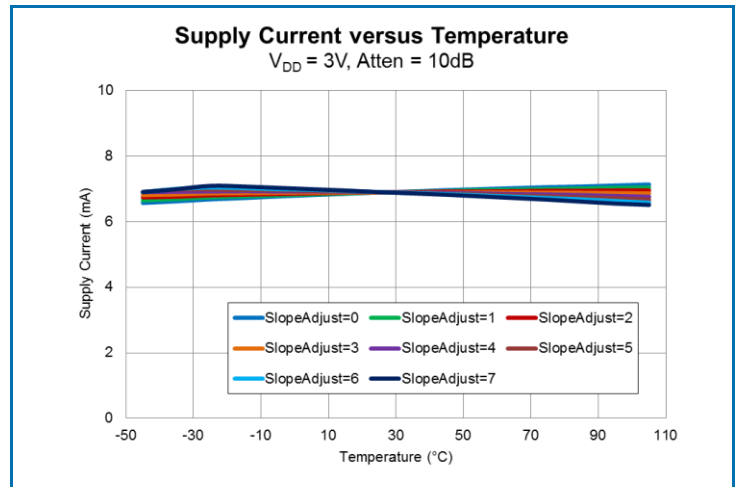
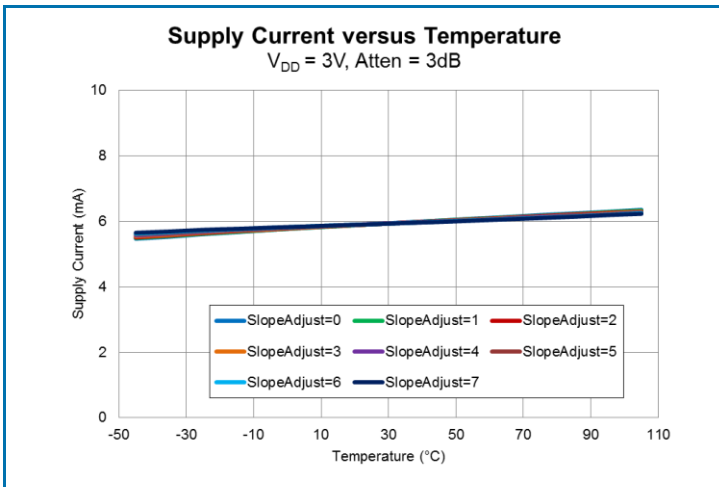
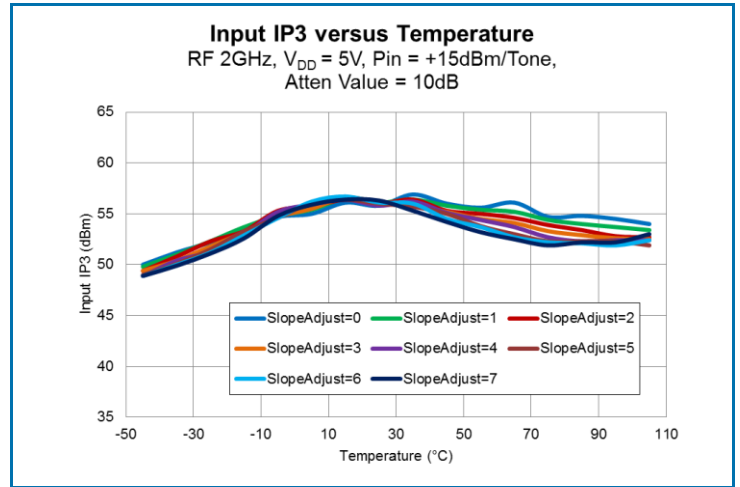
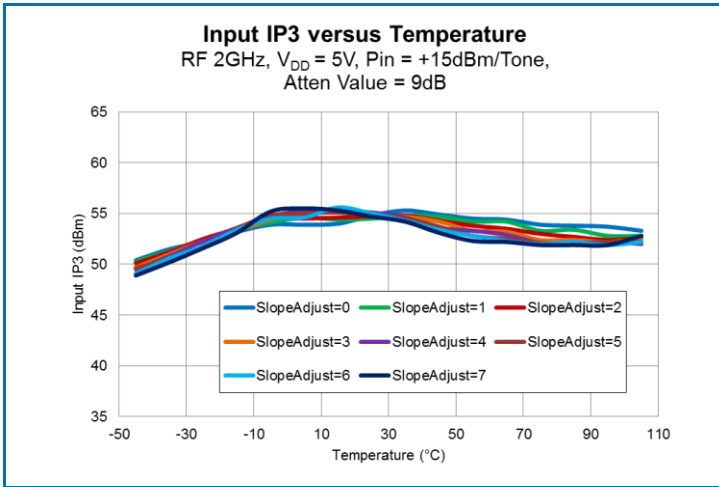

RFSA4033

Evaluation Board Schematic 5MHz to 6000MHz Application Circuit

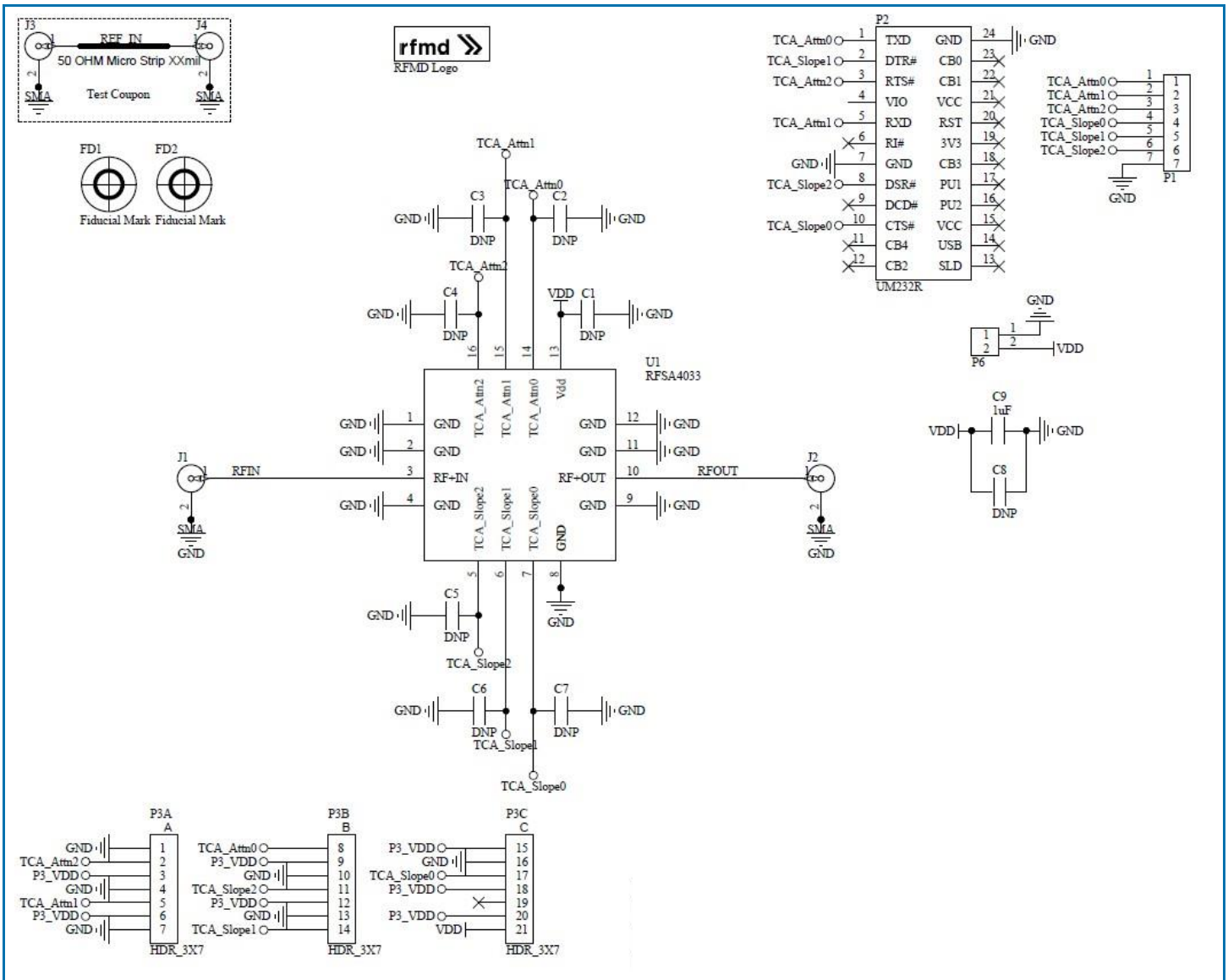

RFSA4033

Evaluation Board Bill of Materials (BOM) 5MHz to 6000MHz Application Circuit

Description	Reference Designator	Manufacturer	Manufacturer's P/N
RFSA4033-410		Dynamic Details (DDI) Toronto	RFSA4033-410(A)
DIGITAL STEP ATTENUATOR 50MHz to 6000MHz	U1	RFMD	RFSA4033SB
CAP, 1µF, 10%, 25V, X7R, 1206	C9	Taiyo Yuden (USA), Inc.	CE TMK316BJ105KL-T
CONN, SMA, END LNCH, UNIV, HYB MNT, FLT	J1-J4	Molex	SD-73251-4000
CONN, HDR, ST, 1x7, 0.100", T/H	P1	Samtec Inc.	TSW-107-07-G-S
CONN, HDR, ST, PLRZD, 2-PIN, 0.100"	P6	ITW Pancon	MPSS100-2-C
CONN, HDR, ST, 3X7, 0.100"	P3	Samtec Inc.	TSW-107-07-G-T
CONN, SKT, 24-PIN DIP, 0.600", T/H	P2	Aries Electronics Inc.	24-6518-10
MOD, USB TO SERIAL UART, SSOP-28	M1	Future Technology Devices Int'l	UM232R
DNP	C1-C8	NA	NA

RFSA4033

Evaluation Board Assembly Drawing

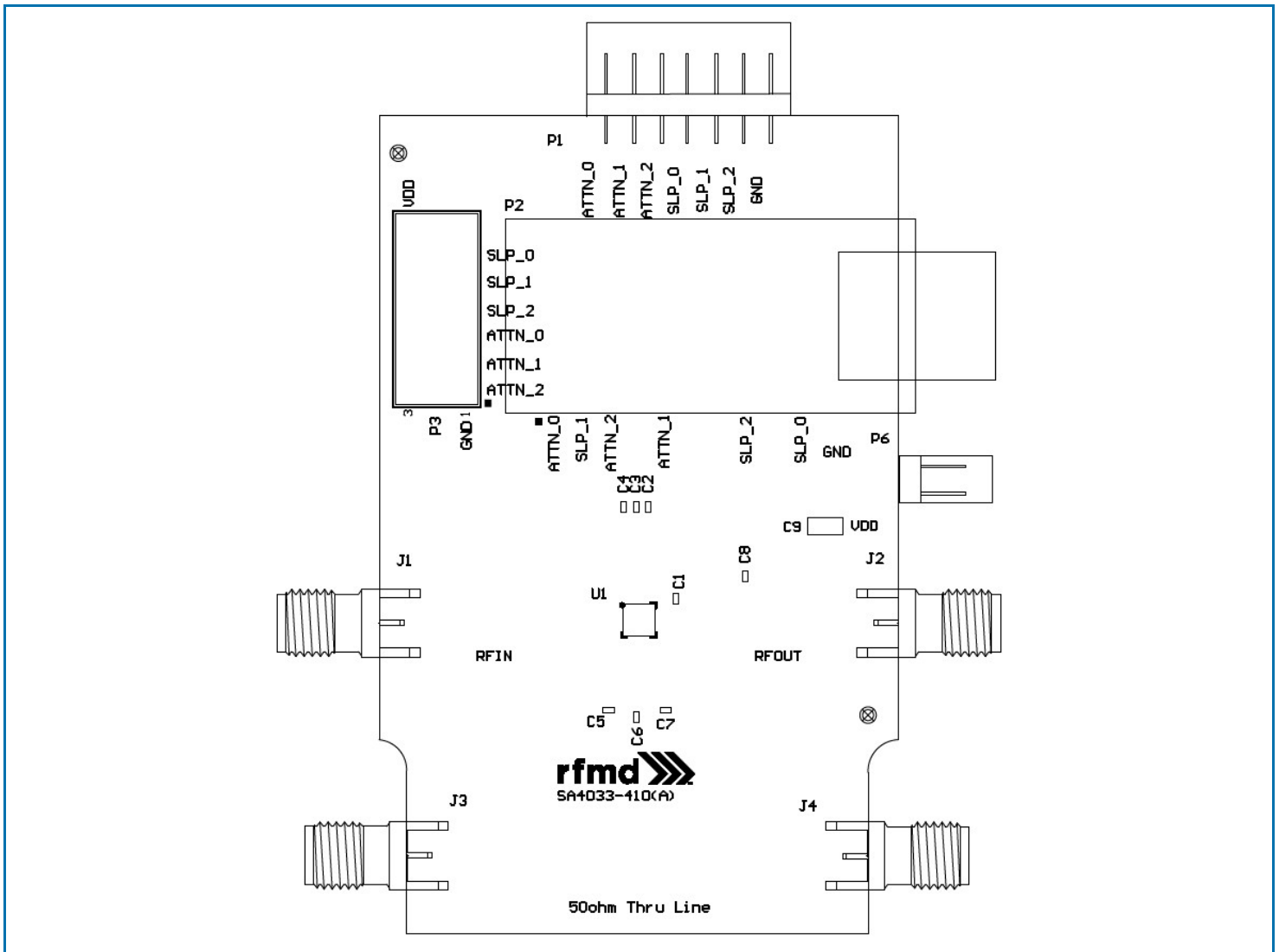

RFSA4033

Pin Names and Descriptions

Pin	Name	Description
1	GND	Connect to PCB ground
2	GND	Connect to PCB ground
3	RFIN	Input RF port; Do not apply DC voltage to this pin. Pin may be grounded externally.
4	GND	Connect to PCB ground
5	SLP2	Input logic bus to control the attenuation slope (MSB)
6	SLP1	Input logic bus to control the attenuation slope
7	SLP0	Input logic bus to control the attenuation slope (LSB)
8	GND	Connect to PCB ground
9	GND	Connect to PCB ground
10	RFOUT	Output RF Port; Do not apply DC voltage to this pin. Pin may be grounded externally.
11	GND	Connect to PCB ground
12	GND	Connect to PCB ground
13	VDD	Supply Voltage
14	ATTN0	Input logic bus to control the 25°C nominal attenuation value (LSB)
15	ATTN1	Input logic bus to control the 25°C nominal attenuation value
16	ATTN2	Input logic bus to control the 25°C nominal attenuation value (MSB)

RFSA4033

Package Outline (Dimensions in millimeters)

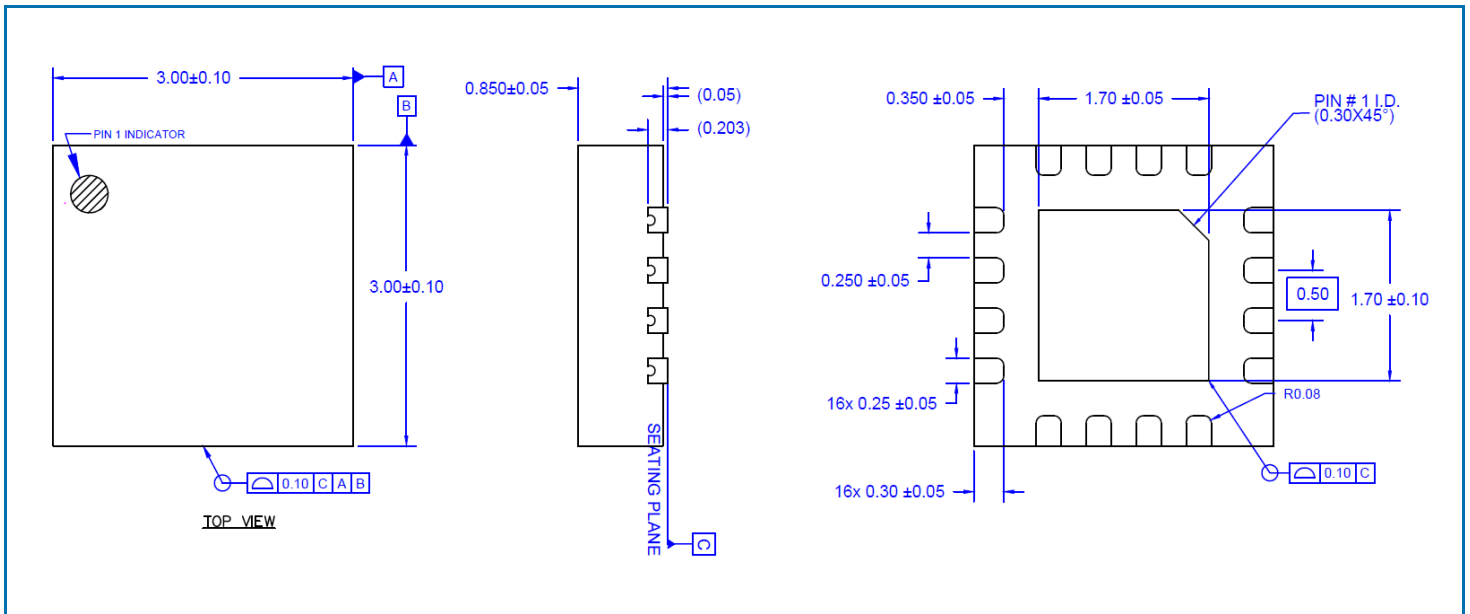

Branding Diagram

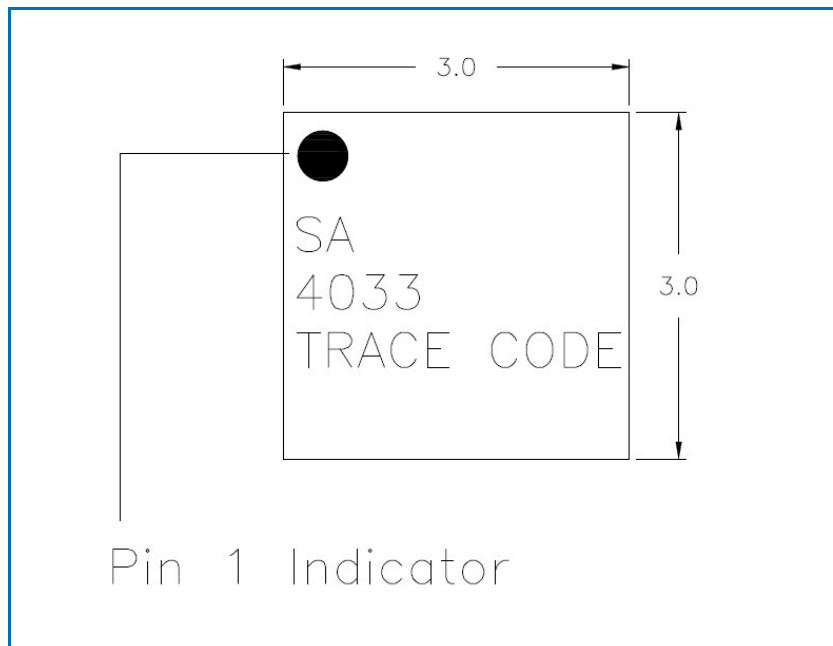

X-ON Electronics

Largest Supplier of Electrical and Electronic Components

Click to view similar products for [Attenuators](#) category:

Click to view products by [Qorvo](#) manufacturer:

Other Similar products are found below :

[HMC305SLP4ETR](#) [MAAD-009195-000100](#) [TGL4201-00](#) [TGL4201-02](#) [TGL4201-03](#) [TGL4201-06](#) [TGL4201-10](#) [ATN3590-15](#) [20-50TPC](#)
[D10AA5Z4](#) [18AH-01](#) [18AH-08](#) [ATN3580-20](#) [ATN3590-09](#) [20-50RP](#) [MASW-008322-000000](#) [PCAF-10](#) [EXB-24AT9AR5X](#) [ATN3580-06](#)
[ATN3580-10](#) [HMC539ALP3ETR](#) [ATN3580-02](#) [ATN3590-07](#) [SKY12408-321LF](#) [ATN3580-03](#) [WA04P005XBTL](#) [HMC-VVD104-SX](#)
[WA04P007XCTL](#) [SKY12236-11](#) [MAATSS0018TR-3000](#) [HMC656-SX](#) [WA04P001XBTL](#) [MAAV-007941-TR3000](#) [WA04P004XBTL](#)
[WA04P002XBTL](#) [C3A50Z4](#) [HMC941A](#) [PAT0816-C-0DB-T5](#) [PAT0816-C-8DB-T5](#) [PAT1632-C-3DB-T1](#) [PAT1632-C-6DB-T1](#) [PAT1632-](#)
[C-10DB-T1](#) [PAT1632-C-1DB-T1](#) [PAT0816-C-2DB-T5](#) [PAT0816-C-4DB-T5](#) [DHM510-0100-006](#) [CMD172](#) [MAT10300](#) [MAT10180](#)
[MAATCC0007-TB](#)