



Product Description

RFMD's SGC2463Z is a high performance SiGe HBT MMIC amplifier utilizing a Darlington configuration with a patented active bias network. The active bias network provides stable current over temperature and process Beta variations. Designed to run directly from a 3V supply, the SGC2463Z does not require a dropping resistor as compared to typical Darlington amplifiers. The SGC2463Z is designed for high linearity 3V gain block applications that require small size and minimal external components. It is internally matched to 50Ω.

Optimum Technology Matching® Applied

- GaAs HBT
- GaAs MESFET
- InGaP HBT
- SiGe BiCMOS
- Si BiCMOS
- SiGe HBT
- GaAs pHEMT
- Si CMOS
- Si BJT
- GaN HEMT
- RF MEMS

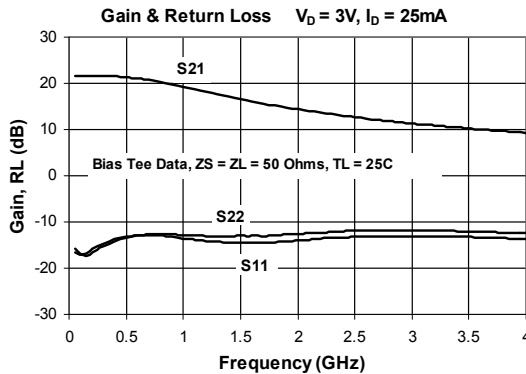

Features

- Single Fixed 3V Supply
- No Dropping Resistor Required
- Patented Self-Bias Circuitry
- $P_{1dB} = 10.5 \text{ dBm}$ at 1950MHz
- $OIP_3 = 23.5 \text{ dBm}$ at 1950MHz
- Robust 1000V ESD, Class 1C HBM

Applications

- PA Driver Amplifier
- Cellular, PCS, GSM, UMTS, WCDMA
- IF Amplifier
- Wireless Data, Satellite

Parameter	Specification			Unit	Condition
	Min.	Typ.	Max.		
Small Signal Gain	17.4	19.8	21.3	dB	850MHz
	12.9	14.4	15.9	dB	1950MHz
		13.4		dB	2400MHz
Output Power at 1dB Compression		10.5		dBm	850MHz
	9.5	10.5		dBm	1950MHz
		9.9		dBm	2400MHz
Output Third Order Intercept Point		22.5		dBm	850MHz
	21.5	23.5		dBm	1950MHz
		24.0		dBm	2400MHz
				dBm	junction - lead
Input Return Loss	10.0	14.0		dB	1950MHz
Output Return Loss	8.5	12.5		dB	1950MHz
Noise Figure		3.5	4.5	dB	1930MHz
Thermal Resistance		255		°C/W	junction - lead
Device Operating Voltage		3.0		V	
Device Operating Current	22.0	26.0	30.0	mA	

Test Conditions: $V_0 = 3V, I_0 = 26 \text{ mA Typ.}, OIP_3 \text{ Tone Spacing} = 1 \text{ MHz}, P_{OUT} \text{ per tone} = -5 \text{ dBm}, T_L = 25^\circ C, Z_S = Z_L = 50 \Omega$

Absolute Maximum Ratings

Parameter	Rating	Unit
Device Current (I_{CE})	55	mA
Device Voltage (V_{CE})	4	V
RF Input Power* (See Note)	12	dBm
Junction Temp (T_J)	+150	°C
Operating Temp Range (T_L)	-55 to +105	°C
Storage Temp	+150	°C
ESD Rating - Human Body Model (HBM)	Class 1C	
Moisture Sensitivity Level	MSL 1	

*Note: Load condition $Z_L = 50\Omega$

Operation of this device beyond any one of these limits may cause permanent damage. For reliable continuous operation, the device voltage and current must not exceed the maximum operating values specified in the table on page one.

Bias Conditions should also satisfy the following expression:

$$I_D V_D < (T_J - T_L) / R_{TH, J-I} \text{ and } T_L = T_{LEAD}$$



Caution! ESD sensitive device.

Exceeding any one or a combination of the Absolute Maximum Rating conditions may cause permanent damage to the device. Extended application of Absolute Maximum Rating conditions to the device may reduce device reliability. Specified typical performance or functional operation of the device under Absolute Maximum Rating conditions is not implied.

RoHS status based on EU Directive 2011/65/EU (at time of this document revision).

The information in this publication is believed to be accurate and reliable. However, no responsibility is assumed by RF Micro Devices, Inc. ("RFMD") for its use, nor for any infringement of patents, or other rights of third parties, resulting from its use. No license is granted by implication or otherwise under any patent or patent rights of RFMD. RFMD reserves the right to change component circuitry, recommended application circuitry and specifications at any time without prior notice.



RFMD Green: RoHS compliant per EU Directive 2011/65/EU, halogen free per IEC 61249-2-21, < 1000 ppm each of antimony trioxide in polymeric materials and red phosphorus as a flame retardant, and <2% antimony in solder.

Typical RF Performance with Application Circuit at Key Operating Frequencies (Bias Tees)

Parameter	Unit	100 MHz	500 MHz	850 MHz	1950 MHz	2400 MHz	3500 MHz
Small Signal Gain (G)	dB	21.7	21.4	19.8	14.4	13.4	10.6
Output Third Order Intercept Point (OIP_3)	dBm	22.5	22.5	22.5	23.5	24.0	22.5
Output Power at 1dB Compression (P_{1dB})	dBm	10.9	10.5	10.5	9.9	8.6	8.6
Input Return Loss (IRL)	dB	15.0	12.0	11.5	14.0	14.5	13.0
Output Return Loss (ORL)	dB	15.0	12.0	11.0	12.5	11.5	12.0
Reverse Isolation (S_{12})	dB	23.5	25.0	25.0	21.0	20.0	19.0
Noise Figure (NF)	dB	2.8	2.8	3.1	3.5	3.6	4.4

Test Conditions: $V_D = 3V$ $I_D = 25mA$ Typ. OIP_3 Tone Spacing = 1MHz, P_{OUT} per tone = -5dBm
 $T_L = 25^\circ C$ $Z_S = Z_L = 50\Omega$

Typical Performance with Bias Tee, $V_D = 3V$, $I_D = 25mA$

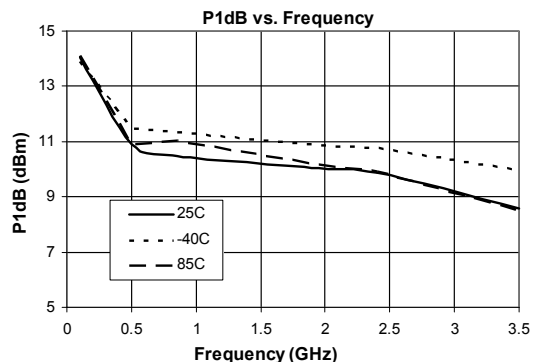
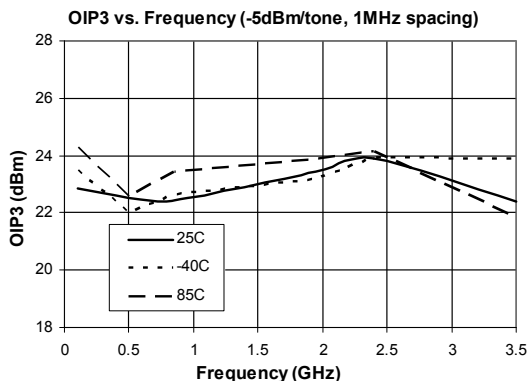

Typical Performance with Bias Tee, $V_D = 3V$, $I_D = 25mA$

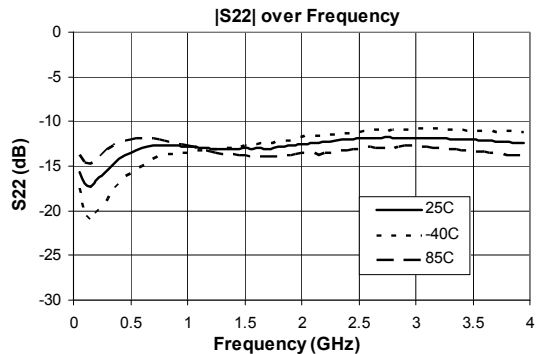
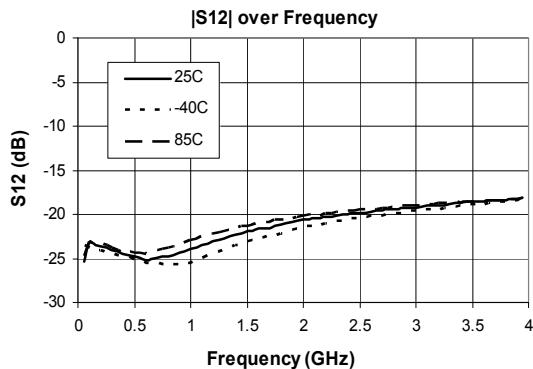
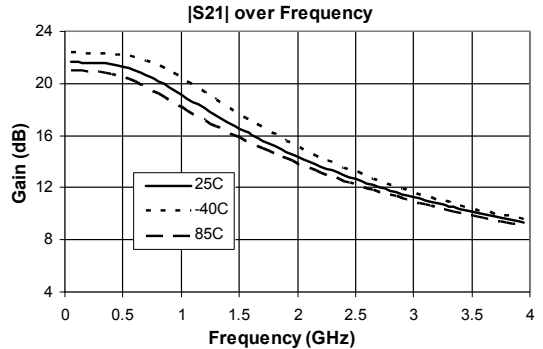
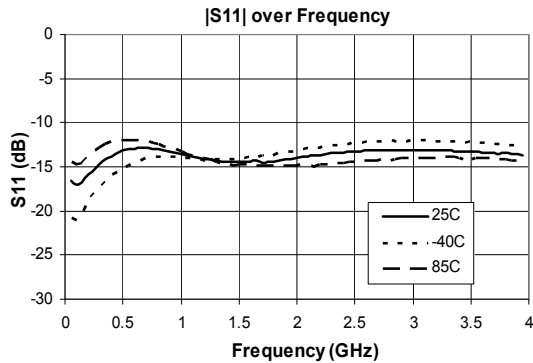
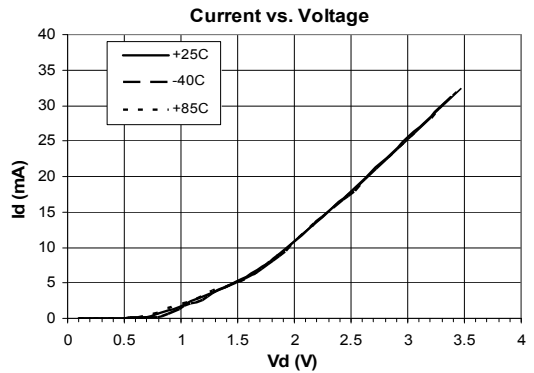
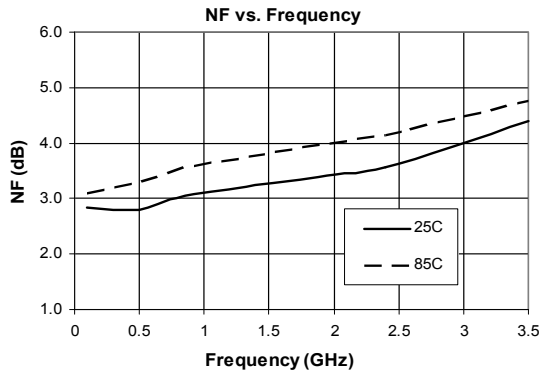

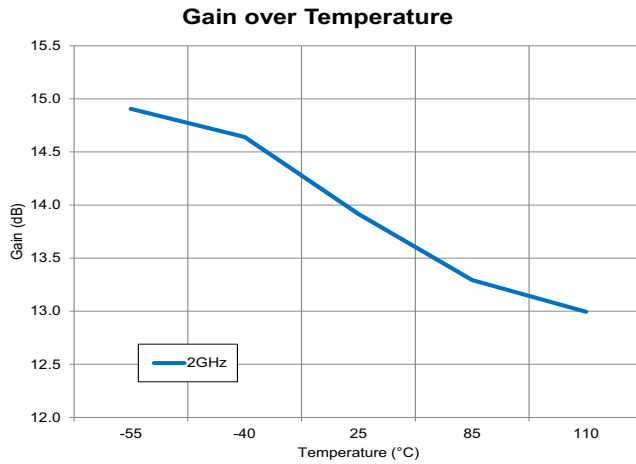

Pin	Function	Description
3	RF IN	RF input pin. This pin requires the use of an external DC blocking capacitor chosen for the frequency of operation.
1, 2, 4, 5	GND	Connection to ground. Use via holes as close to the device ground leads as possible to reduce ground inductance and achieve optimum RF performance.
6	RF OUT/DC BIAS	RF output and bias pin. This pin requires the use of an external DC blocking capacitor chosen for the frequency of operation.

SOT-363 PCB Pad Layout

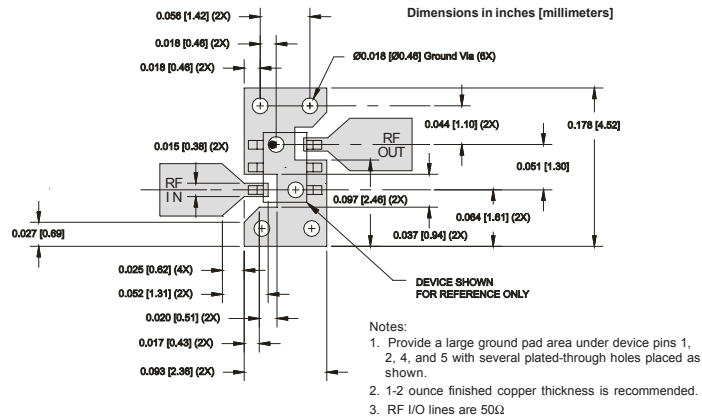

SOT-363 Nominal Package Dimensions

Dimensions in inches (millimeters)
 Refer to drawing posted at www.rfmd.com for tolerances.

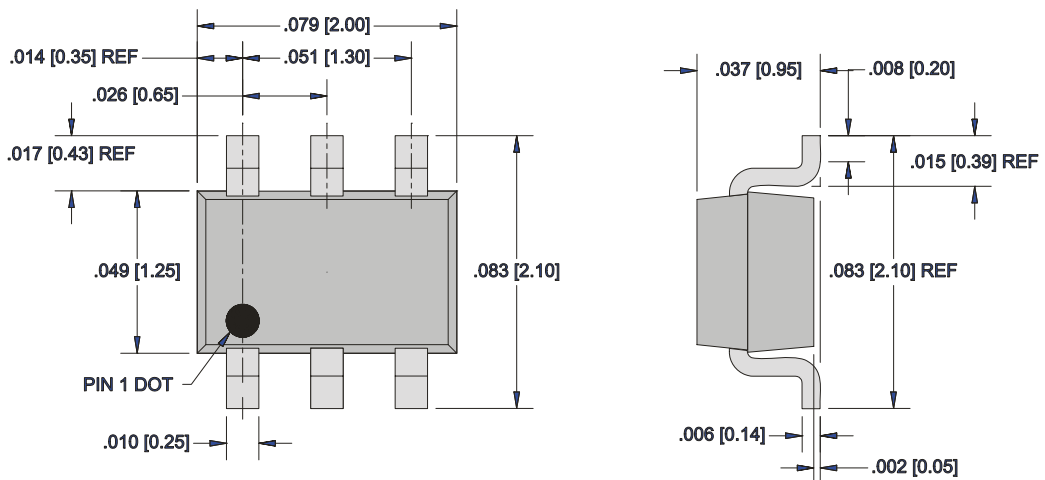

Application Schematic

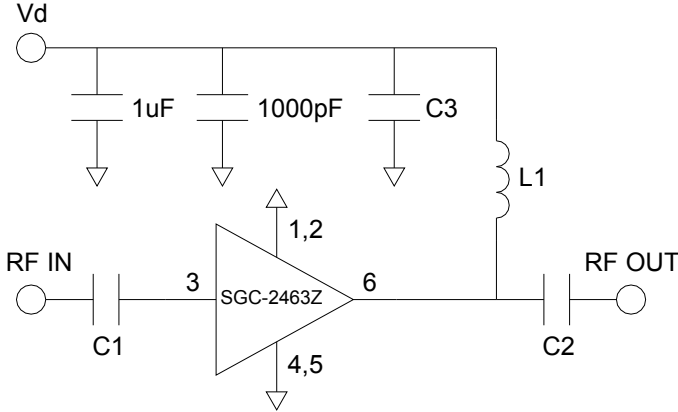

Application Circuit Element Values		
Reference Designator	100-2000MHz	2000-4000MHz
C1	1000pF	2.7pF
C2	100pF	6.8pF
C3	100pF	6.8pF
L1	150nH	39nH

Evaluation Board Layout

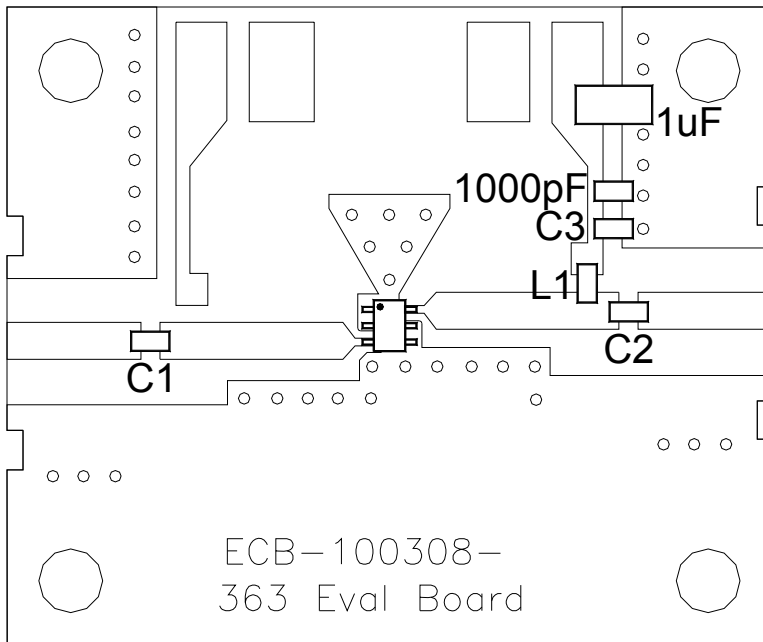

Alternate Marking with Trace Code Only

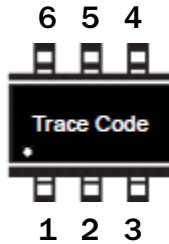

Ordering Information

Ordering Code	Description
SGC2463Z	7" Reel with 3000 pieces
SGC2463ZSQ	Sample bag with 25 pieces
SGC2463ZSR	7" Reel with 100 pieces
SGC2463ZPCK1	100MHz to 2000MHz PCBA with 5-piece sample bag
SGC2463ZPCK2	2000MHz to 4000MHz PCBA with 5-piece sample bag

X-ON Electronics

Largest Supplier of Electrical and Electronic Components

Click to view similar products for [RF Amplifier](#) category:

Click to view products by [Qorvo](#) manufacturer:

Other Similar products are found below :

[A82-1](#) [BGA622H6820XTSA1](#) [BGA 728L7 E6327](#) [BGB719N7ESDE6327XTMA1](#) [HMC397-SX](#) [HMC405](#) [HMC561-SX](#) [HMC8120-SX](#)
[HMC8121-SX](#) [HMC-ALH382-SX](#) [HMC-ALH476-SX](#) [SE2433T-R](#) [SMA3101-TL-E](#) [SMA39](#) [A66-1](#) [A66-3](#) [A67-1](#) [LX5535LQ](#) [LX5540LL](#)
[MAAM02350](#) [HMC3653LP3BETR](#) [HMC549MS8GETR](#) [HMC-ALH435-SX](#) [SMA101](#) [SMA32](#) [SMA411](#) [SMA531](#) [SST12LP17E-XX8E](#)
[SST12LP19E-QX6E](#) [WPM0510A](#) [HMC5929LS6TR](#) [HMC5879LS7TR](#) [HMC1126](#) [HMC1087F10](#) [HMC1086](#) [HMC1016](#) [SMA1212](#)
[MAX2689EWS+T](#) [MAAMSS0041TR](#) [MAAM37000-A1G](#) [LTC6430AIUF-15#PBF](#) [CHA5115-QDG](#) [SMA70-2](#) [SMA4011](#) [A231](#) [HMC-](#)
[AUH232](#) [LX5511LQ](#) [LX5511LQ-TR](#) [HMC7441-SX](#) [HMC-ALH310](#)