

Package: QFN, 4 mm x 4 mm



Product Description

RFMD's SZA-5044 is a high efficiency class AB Heterojunction Bipolar Transistor (HBT) amplifier housed in a low-cost surface-mountable plastic package. This HBT amplifier is made with InGaP on GaAs device technology and fabricated with MOCVD for an ideal combination of low cost and high reliability. This product is specifically designed as a final or driver stage for 802.11a equipment in the 4.9GHz to 5.9GHz band for a 5V supply. Optimized on-chip impedance matching circuitry provides a 50Ω nominal RF input impedance. A single external output matching circuit covers the entire 4.9GHz to 5.9GHz band simultaneously. The external output match allows for load line optimization for other applications or optimized performance over narrower bands. This product is available in a RoHS Compliant and Green package with matte tin finish, designated by the "Z" package suffix.

Optimum Technology Matching® Applied

- GaAs HBT
- GaAs MESFET
- InGaP HBT
- SiGe BiCMOS
- Si BiCMOS
- SiGe HBT
- GaAs pHEMT
- Si CMOS
- Si BJT
- GaN HEMT
- RF MEMS

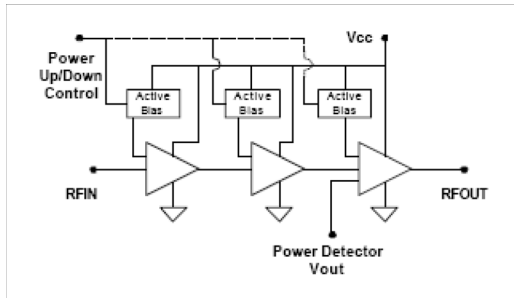

Features

- 802.11a 54 Mb/s Class AB Performance $P_{OUT} = 22 \text{ dBm}$ at 3% EVM, 5V, 343 mA
- High Gain = 33 dB
- Output Return Loss > 11 dB for Linear Tune
- On-Chip Output Power Detector
- $P_{1dB} = 30 \text{ dBm}$ at 5V
- Simultaneous 4.9 GHz to 5.9 GHz Performance
- Robust - Survives RF Input Power = +15 dBm
- Power Up/Down Control < 1 ms, $V_{PC} 2.9 \text{ V to } 5 \text{ V}$

Applications

- 802.11a WiFi, OFDM
- 5.8 GHz ISM Band, 802.16 WiMAX

Parameter	Specification			Unit	Condition
	Min.	Typ.	Max.		
Frequency of Operation	4900		5900	MHz	
Output Power at 1dB Compression		30.2		dBm	5.15 GHz
	27.5	29.0		dBm	5.875 GHz
Gain	30.7	32.7	34.7	dB	4.9 GHz
		33.0		dB	5.15 GHz
	25.7	27.7	29.7	dB	5.875 GHz
Output Power		21.0		dBm	3% EVM 802.11a 54 Mb/s-5.15 GHz
		22.0		dBm	3% EVM 802.11a 54 Mb/s-5.875 GHz
Noise Figure		6.3		dB	5.875 GHz
Third Order Intermod		-39.0	-35.0	dBc	5.875 GHz, 18 dBm per tone
Worst Case Input Return Loss	8.6	11.6		dB	4.9 GHz to 5.875 GHz
Worst Case Output Return Loss	9.3	12.3		dB	4.9 GHz to 5.875 GHz
Output Voltage Range		0.8 to 1.9		V	$P_{OUT} = 10 \text{ dBm to } 26 \text{ dBm}$
V_{CC} Quiescent Current	230	270	310	mA	
Power Up Control Current		1.7		mA	$V_{PC} = 5 \text{ V}$ ($I_{VPC1} + I_{VPC2} + I_{VPC3}$)
Off V_{CC} Leakage Current		8	100	uA	$V_{PC} = 0 \text{ V}$
Thermal Resistance (junction-lead)		24		°C/W	junction - lead
802.11ac Output power		21.0		dBm	1.8% EVM 802.11ac HT80 MCS9 5.21 GHz to 5.77 GHz
802.11ac Operating Current		330		mA	$P_{OUT} = 21 \text{ dBm}$

Test Conditions: $Z_0 = 50 \Omega$, $V_{CC} = 5 \text{ V}$, $I_{CQ} = 270 \text{ mA}$, $T_{BP} = 25 \text{ °C}$

Absolute Maximum Ratings

Parameter	Rating	Unit
VC3 Collector Bias Current (pin 16)	500	mA
VC2 Collector Bias Current (pin 18)	225	mA
VC1 Collector Bias Current (pin 19)	75	mA
Device Voltage (V_D), No RF drive	7.0	V
Power Dissipation	3.4	W
Operating Lead Temperature (T_L)	-40to+85	°C
RF Input Power for 50Ω RF out load	15	dBm
RF Input Power for 10:1 VSWR RF out load	2	dBm
Storage Temperature Range	-40to+150	°C
Operating Junction Temperature (T_J)	150	°C
ESD Rating - Human Body Model (HBM)	> 1000	V

Operation of this device beyond any one of these limits may cause permanent damage. For reliable continuous operation, the device voltage and current must not exceed the maximum operating values specified in the table on page one.

Bias Conditions should also satisfy the following expression:

$$I_D V_D < (T_J - T_L) / R_{TH, J}$$



Caution! ESD sensitive device.

Exceeding any one or a combination of the Absolute Maximum Rating conditions may cause permanent damage to the device. Extended application of Absolute Maximum Rating conditions to the device may reduce device reliability. Specified typical performance or functional operation of the device under Absolute Maximum Rating conditions is not implied.

RoHS status based on EUDirective2002/95/EC (at time of this document revision).

The information in this publication is believed to be accurate and reliable. However, no responsibility is assumed by RF Micro Devices, Inc. ("RFMD") for its use, nor for any infringement of patents, or other rights of third parties, resulting from its use. No license is granted by implication or otherwise under any patent or patent rights of RFMD. RFMD reserves the right to change component circuitry, recommended application circuitry and specifications at any time without prior notice.

Simplified Device Schematic

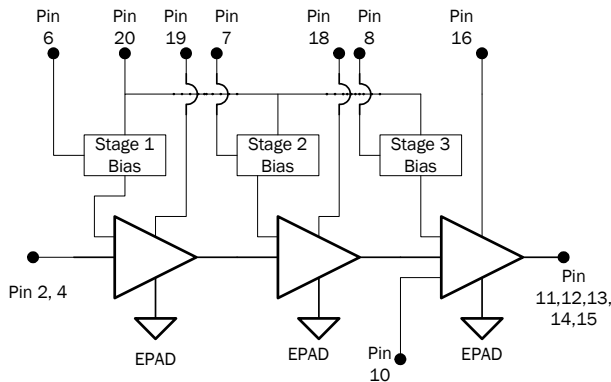

L

Pin	Function	Description
1, 3, 5, 9, 11, 15, 17	N/C	Pins are not used. May be grounded, left open, or connected to adjacent pin.
6	VPC1	VPC1 is the bias control pin for the stage 1 active bias circuit and can be run from 2.9V to 5V control. An external series resistor is required for proper setting of bias levels depending on control voltage. Refer to the evaluation board schematic for resistor value. To prevent potential damage, do not apply voltage to this pin that is +1V greater than voltage applied to pin 20 (Vbias) unless Vpc supply current capability is less than 10mA.
7	VPC2	VPC2 is the bias control pin for the stage 2 active bias circuit and can be run from 2.9V to 5V control. An external series resistor is required for proper setting of bias levels depending on control voltage. Refer to the evaluation board schematic for resistor value. To prevent potential damage, do not apply voltage to this pin that is +1V greater than voltage applied to pin 20 (Vbias) unless Vpc supply current capability is less than 10mA.
8	VPC3	VPC3 is the bias control pin for the stage 3 active bias circuit and can be run from 2.9V to 5V control. An external series resistor is required for proper setting of bias levels depending on control voltage. Refer to the evaluation board schematic for resistor value. To prevent potential damage, do not apply voltage to this pin that is +1V greater than voltage applied to pin 20 (Vbias) unless Vpc supply current capability is less than 10mA.
10	VDET	Output power detector voltage. Load with 10K to 100K Ω to ground for best performance.
2, 4	RF IN	RF input pins. This is DC grounded internal to the IC. Do not apply voltage to this pin. All three pins must be used for proper operation.
12, 13, 14	RF OUT	RF output pin. This is also another connection to the 3rd stage collector
16	VC3	3rd stage collector bias pin. Apply 5V to this pin.
18	VC2	2nd stage collector bias pin. Apply 5V to this pin.
19	VC1	1st stage collector bias pin. Apply 5V to this pin.
20	VBIAS	Active bias network VCC. Apply 5V to this pin.
EPAD	GND	Exposed area on the bottom side of the package needs to be soldered to the ground plane of the board for optimum thermal and RF performance. Several vias should be located under the EPAD as shown in the recommended land pattern (page 5).

4.9GHz to 5.9GHz Evaluation Board Data ($V_{BIAS}=5.0V$, $I_Q=270mA$)

Broadband S11 - Input Return Loss

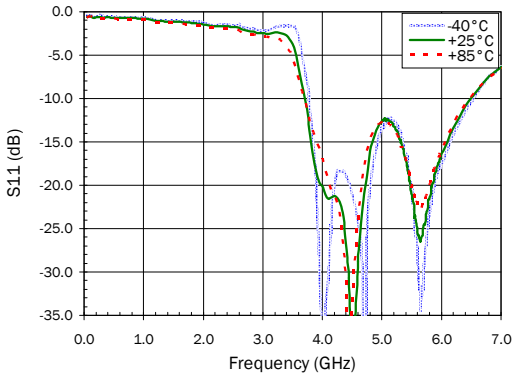

Broadband S21 - Forward Gain

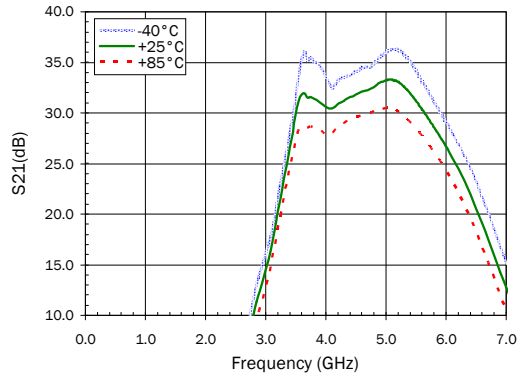

Broadband S22 - Output Return Loss

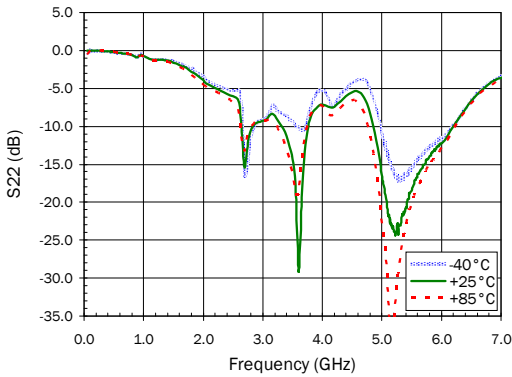

Typical Gain versus P_{OUT} , $T=+25^\circ C$

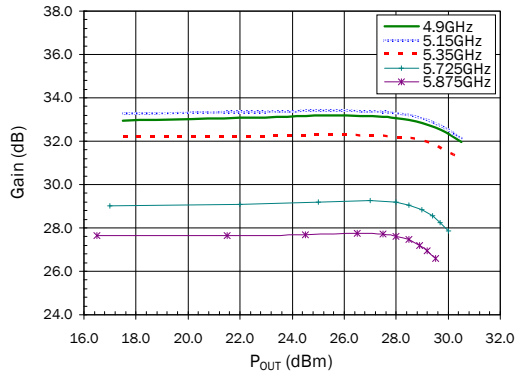

DC Supply Current versus P_{OUT} , $T=+25^\circ C$

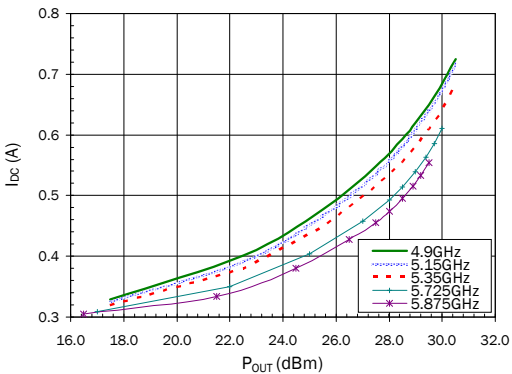

I_{DC} (DC bias point) vs V_{supply} ($V+$ and V_{pc})

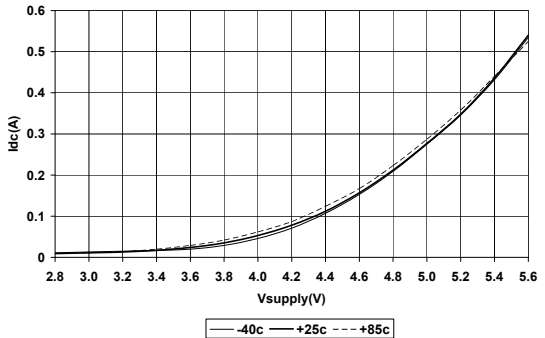

4.9GHz to 5.9GHz Evaluation Board Data ($V_{BIAS}=5.0V$, $I_Q=270mA$)
 802.11a EVM, OFDM, 54Mb/s, 64QAM

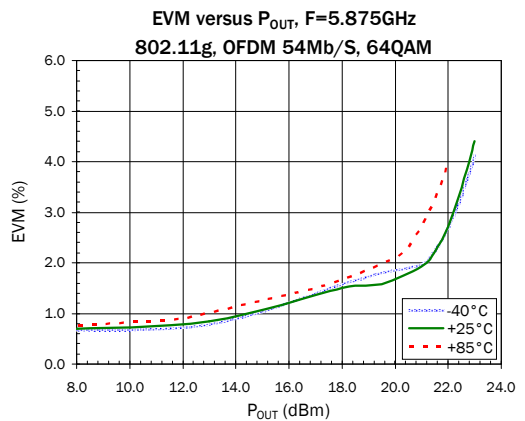
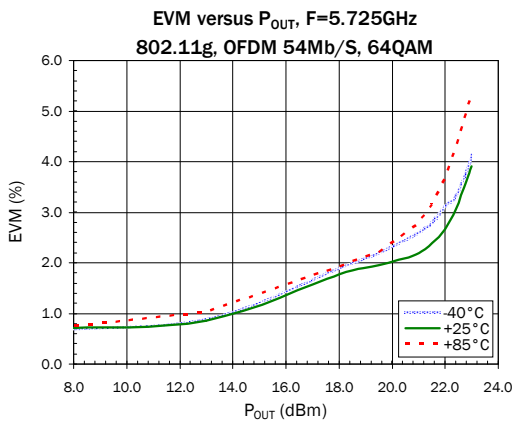
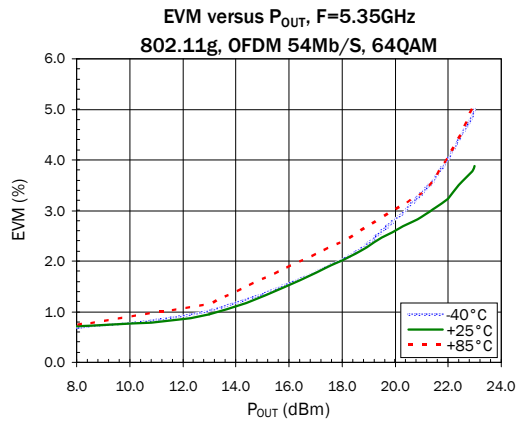
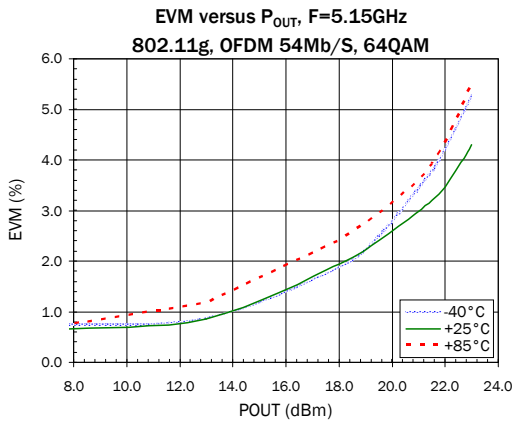
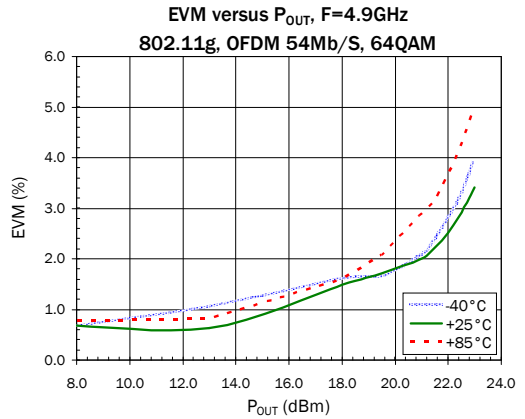
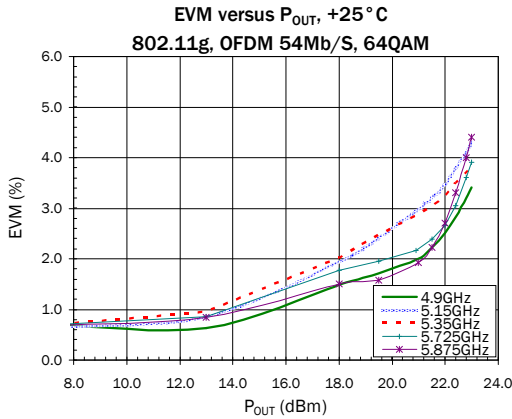

5.21GHz to 5.775GHz Evaluation Board Data ($V_{BIAS}=5.0V$, $I_Q=270mA$) 802.11ac EVM, HT80 MCS9

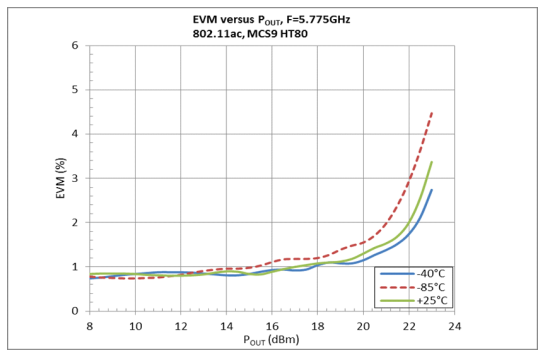
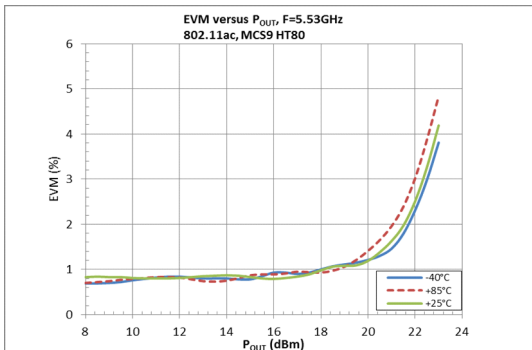
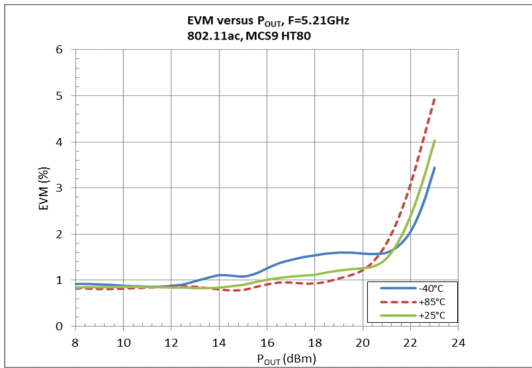
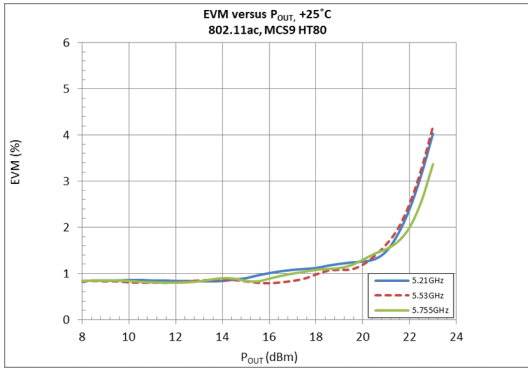

4.9GHz to 5.9GHz Evaluation Board Data ($V_{BIAS}=5.0V$, $I_Q=270mA$)

IM3 versus P_{OUT} (2 Tone Avg.), $T=25^\circ C$
Tone Spacing=1MHz

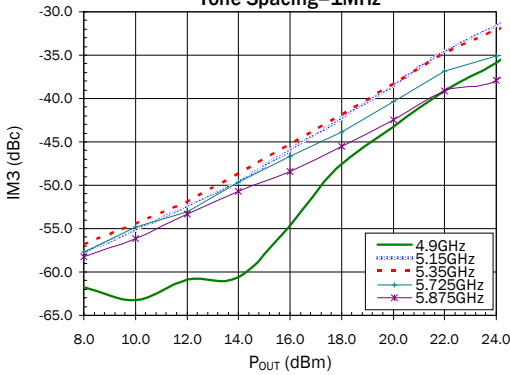

RF Power Detector (V_{DET}) versus P_{OUT} , $F=4.9GHz$

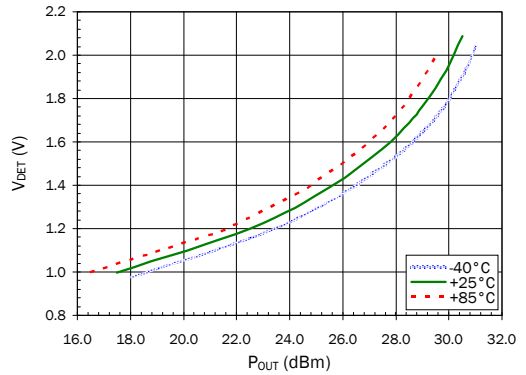

RF Power Detector (V_{DET}) versus P_{OUT} , $F=5.15GHz$

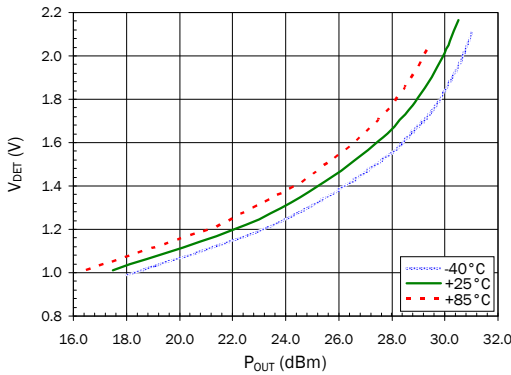

RF Power Detector (V_{DET}) versus P_{OUT} , $F=5.35GHz$

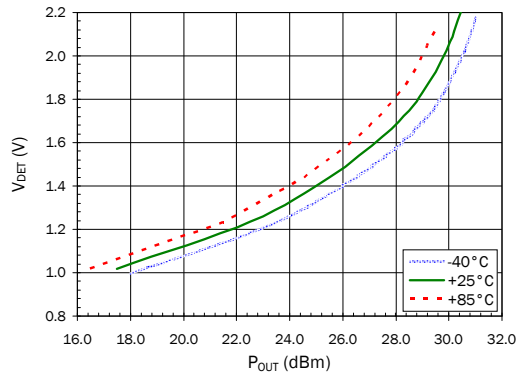

RF Power Detector (V_{DET}) versus P_{OUT} , $F=5.725GHz$

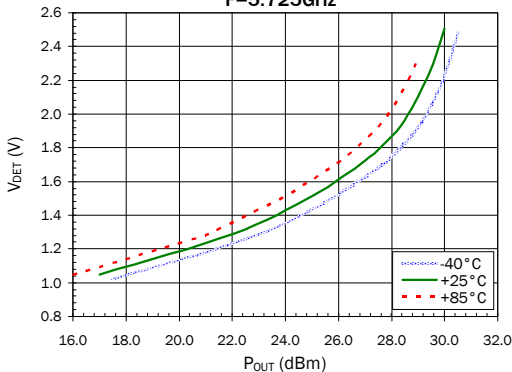

RF Power Detector (V_{DET}) versus P_{OUT} , $F=5.875GHz$

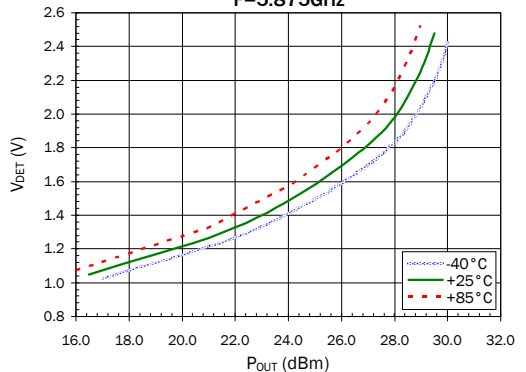

Evaluation Board Schematic for $V^+ = V_{CC} = 5.0V$ (4.9GHz to 5.9GHz)

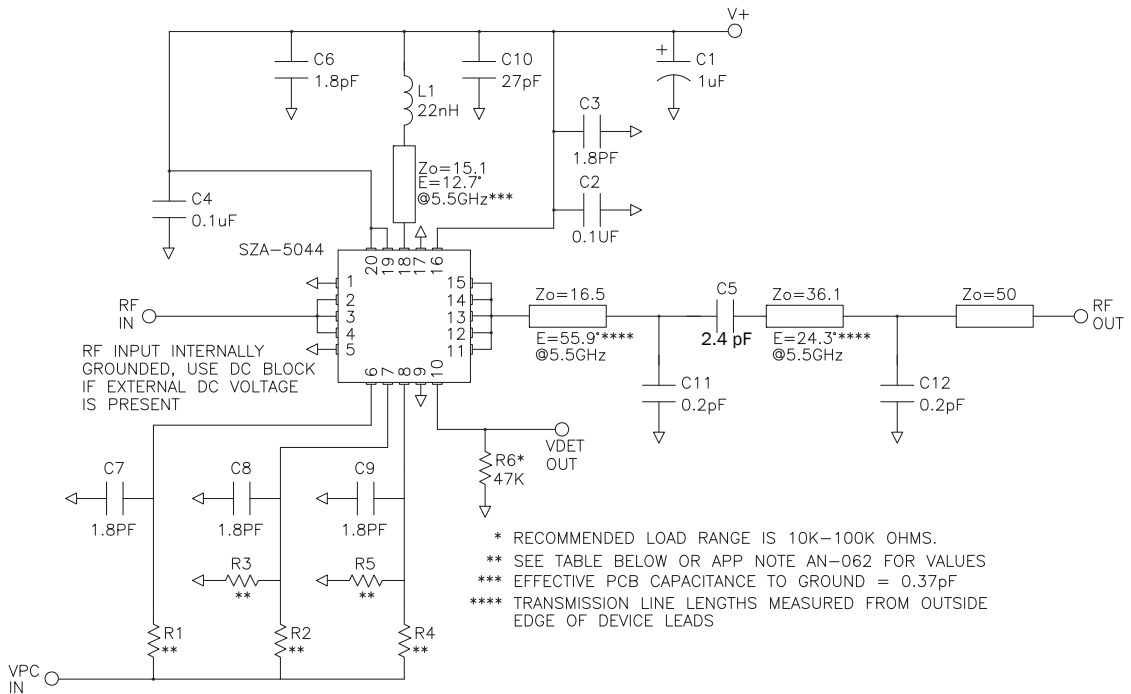

Notes: Pins 1, 3, 5, 9, 11, 15, and 17 are unwired (N/C) inside the package. Refer to page 2 for detailed pin descriptions. Some of these pins are wired to adjacent pins or grounded as shown in the application circuit. This is to maintain consistency with the evaluation board layout shown below. It is recommended to use this layout and wiring to achieve the specified performance.

To prevent potential damage, do not apply voltage to the V_{PC} pin that is +1V greater than voltage applied to pin 20 (V_{BIAS}/V_{CC}) unless V_{PC} supply current capability is less than 10mA.

Evaluation Board Layout for $V_+ = V_{CC} = 5.0V$

(4.9GHz to 5.9GHz)

Board material GETEK, 10mil thick, $D_k = 3.9$, 2oz. copper finish

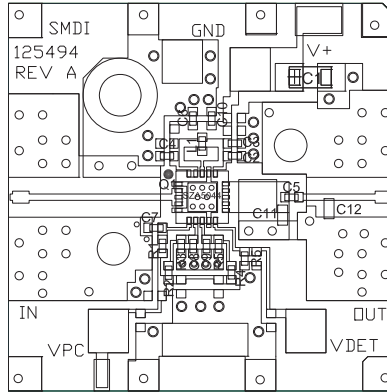

PCB notes: Do not use less than recommended ground via holes.

RF Layers thicker than .020 inches (0.5mm) not recommended.

DESG	Description
Q1	SZA-5044
R1, 2, 3, 4, 5, 6	1%, 0402
C1	1uF 15V TANTALUM CAP
C2, 4	0.1uF CAP, 0402
C3, 6, 7, 8, 9	1.8pF Cap, 0402
C5	2.4pF Cap, 0402
C10	27pF Cap, 0402
L1	22nH IND, 0402
C11, 12	0.2pF Cap, 0603

Resistor values for $V_{PC} = 2.9V$ to $5V$ ($V_{CC} = 5V$, $I_Q = 270mA$)

VPC(V)	R1	R2	R4	R3	R5
2.9	0	698	10	OUT	OUT
3.0	174	1.1K	281	OUT	OUT
3.1	348	1.37K	499	OUT	OUT
3.2	511	1.78K	750	OUT	OUT
3.3	698	2.15K	1.00K	OUT	OUT
5.0	3.6K	2.2K	2.4K	7.5K	7.5K

Note: See app note for V_{CC} and V_{PC} combinations

Package Drawing

Dimensions in millimeters (inches)

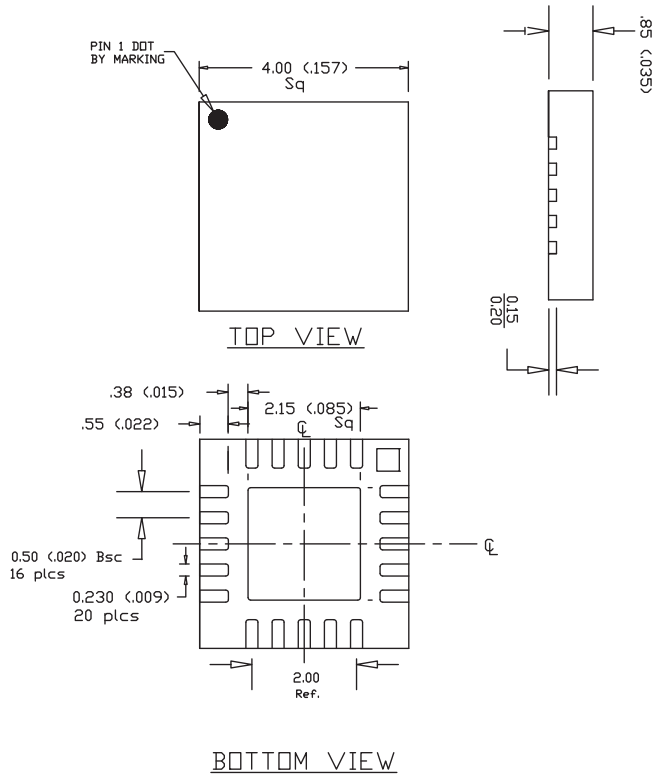

Recommended Land Pattern

Dimensions in millimeters (inches)

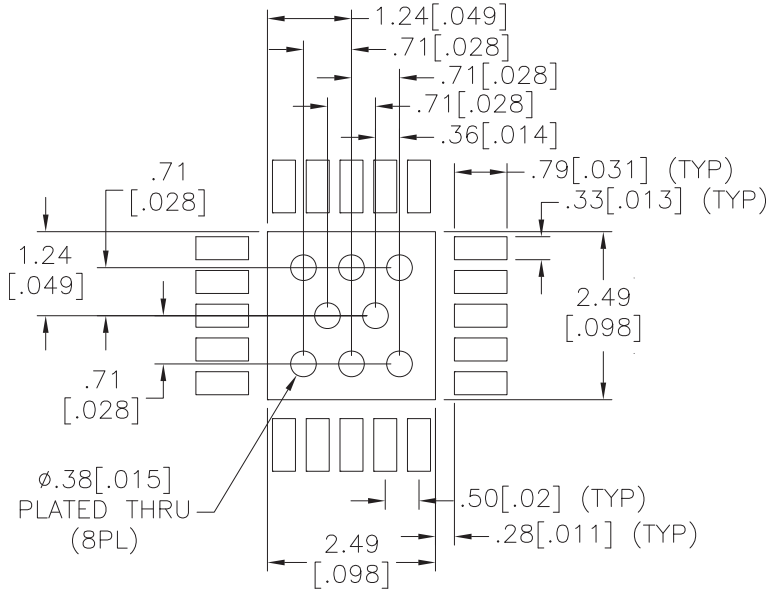

Recommended PCB Soldermask (SMBOC) for Land Pattern

Dimensions in millimeters (inches)

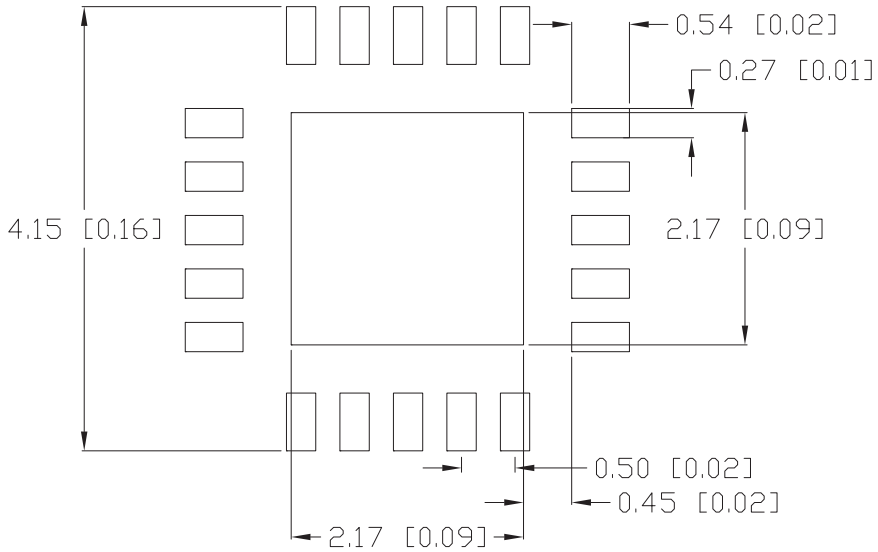

Part Symbolization

The part will be symbolized with an “SZA-5044” for Sn/Pb plating or “SZA-5044Z” for RoHS green compliant product. Marking designator will be on the top surface of the package.

Ordering Information

Ordering Code	Description
SZA5044ZSQ	Standard 25 piece bag
SZA5044ZSR	Standard 100 piece reel
SZA5044Z	Standard 1000 piece reel
SZA5044Z-EVB1	Evaluation Board 4.9GHz to 5.9 GHz Tune

X-ON Electronics

Largest Supplier of Electrical and Electronic Components

Click to view similar products for [RF Amplifier](#) category:

Click to view products by [Qorvo](#) manufacturer:

Other Similar products are found below :

[A82-1](#) [BGA622H6820XTSA1](#) [BGA 728L7 E6327](#) [BGB719N7ESDE6327XTMA1](#) [HMC397-SX](#) [HMC405](#) [HMC561-SX](#) [HMC8120-SX](#)
[HMC8121-SX](#) [HMC-ALH382-SX](#) [HMC-ALH476-SX](#) [SE2433T-R](#) [SMA3101-TL-E](#) [SMA39](#) [A66-1](#) [A66-3](#) [A67-1](#) [LX5535LQ](#) [LX5540LL](#)
[MAAM02350](#) [HMC3653LP3BETR](#) [HMC549MS8GETR](#) [HMC-ALH435-SX](#) [SMA101](#) [SMA32](#) [SMA411](#) [SMA531](#) [SST12LP19E-QX6E](#)
[WPM0510A](#) [HMC5929LS6TR](#) [HMC5879LS7TR](#) [HMC1126](#) [HMC1087F10](#) [HMC1086](#) [HMC1016](#) [SMA1212](#) [MAX2689EWS+T](#)
[MAAMSS0041TR](#) [MAAM37000-A1G](#) [LTC6430AIUF-15#PBF](#) [CHA5115-QDG](#) [SMA70-2](#) [SMA4011](#) [A231](#) [HMC-AUH232](#) [LX5511LQ](#)
[LX5511LQ-TR](#) [HMC7441-SX](#) [HMC-ALH310](#) [XD1001-BD-000V](#)