

Package: QFN, 6mm x 6mm



### Product Description

RFMD's SZM-3066Z is a high linearity class AB Heterojunction Bipolar Transistor (HBT) amplifier housed in a low-cost surface-mountable plastic Q-FlexN multi-chip module package. This HBT amplifier is made with InGaP on GaAs device technology and fabricated with MOCVD for an ideal combination of low cost and high reliability. This product is specifically designed as a final or driver stage for 802.16 equipment in the 3.3GHz to 3.8GHz bands. It can run from a 3V to 6V supply. The external output match and bias adjustability allows load line optimization for other applications or over narrower bands. It features an output power detector, on/off power control and high RF overdrive robustness. A 20dB step attenuator feature can be utilized by switching the second stage Power up/down control. This product features a RoHS compliant and Green package with matte tin finish, designated by the 'Z' suffix.

#### Optimum Technology Matching® Applied

- GaAs HBT
- GaAs MESFET
- InGaP HBT
- SiGe BiCMOS
- Si BiCMOS
- SiGe HBT
- GaAs pHEMT
- Si CMOS
- Si BJT
- GaN HEMT
- RF MEMS

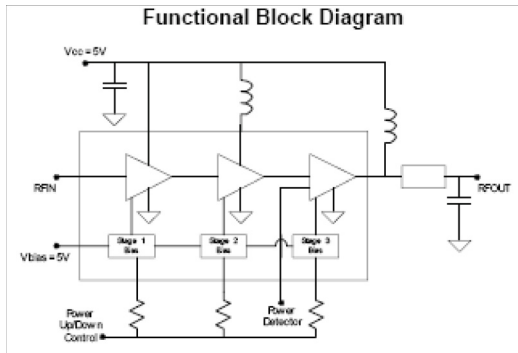

### Features

- $P_{1dB} = 33.5 \text{ dBm}$  at 5V
- Three Stages of Gain: 34 dB
- 802.11g 54 Mb/s Class AB Performance
- $P_{OUT} = 26 \text{ dBm}$  at 2.5% EVM,  $V_{CC} = 5 \text{ V}$ , 730 mA
- Active Bias with Adjustable Current
- On-Chip Output Power Detector
- Low Thermal Resistance
- Power Up/Down Control  $< 1 \mu\text{s}$
- Attenuator Step 20dB at  $V_{PC2} = 0 \text{ V}$
- Class 1B ESD Rating

### Applications

- 802.16 WiMAX Driver or Output Stage
- Fixed Wireless, WLL

Parameter	Specification			Unit	Condition
	Min.	Typ.	Max.		
Frequency of Operation	3300		3800	MHz	
Output Power at 1dB Compression		33.5		dBm	3.5GHz
Gain	32.5	34.0		dBm	@ $P_{OUT} = 26 \text{ dBm}$ - 3.5GHz
Output power		26.0		dBm	@ 2.5% EVM 802.11g 54Mb/s - 3.5GHz
Third Order Suppression		-38.0	-33.0	dBc	$P_{OUT} = 23 \text{ dBm}$ per tone - 3.5GHz
Noise Figure		5.0		dB	@ 3.6GHz
Worst Case Input Return Loss	11.0	14.0		dB	3.3GHz to 3.8GHz
Worst Case Output Return Loss	6.0	9.0		dB	3.3GHz to 3.8GHz
Supply voltage range	3.0	5.0	6.0	V	
Output Voltage Range		0.9 to 2.2		V	for $P_{OUT} = 10 \text{ dBm}$ to 30dBm
Quiescent Current	540	600	660	mA	$V_{CC} = 5 \text{ V}$
Power Up Control Current		5.0		mA	$V_{PC} = 5 \text{ V}$ , $I_{VPC1} + I_{VPC2} + I_{VPC3}$
VCC Leakage Current			0.1	mA	$V_{CC} = 5 \text{ V}$ , $V_{PC} = 0 \text{ V}$
Thermal Resistance		12.0		$^{\circ}\text{C/W}$	junction - lead

Test Conditions: 3.3GHz to 3.8GHz App circuit,  $Z_0 = 50 \Omega$ ,  $V_{CC} = 5 \text{ V}$ ,  $I_Q = 600 \text{ mA}$ ,  $T_{BP} = 30^{\circ}\text{C}$

## Absolute Maximum Ratings

Parameter	Rating	Unit
VC3 Collector Bias Current ( $I_{VC3}$ )	1500	mA
VC2 Collector Bias Current ( $I_{VC2}$ )	600	mA
VC1 Collector Bias Current ( $I_{VC1}$ )	300	mA
*Device Voltage ( $V_D$ )	9.0	V
Power Dissipation	6	W
**Max RF output Power for 50 $\Omega$ continuous long term operation	30	dBm
Max RF Input Power for 10:1 VSWR output load	5	dBm
Storage Temperature Range	-40 to +150	$^{\circ}$ C
Operating Temp Range ( $T_L$ )	-40 to +85	$^{\circ}$ C
ESD Rating - Human Body Model	500	V
Maximum Junction Temperature for long term reliability, $T_J$ Max	150	$^{\circ}$ C



**Caution!** ESD sensitive device.

Exceeding any one or a combination of the Absolute Maximum Rating conditions may cause permanent damage to the device. Extended application of Absolute Maximum Rating conditions to the device may reduce device reliability. Specified typical performance or functional operation of the device under Absolute Maximum Rating conditions is not implied.

RoHS status based on EU Directive 2011/65/EU (at time of this document revision).

The information in this publication is believed to be accurate and reliable. However, no responsibility is assumed by RF Micro Devices, Inc. ("RFMD") for its use, nor for any infringement of patents, or other rights of third parties, resulting from its use. No license is granted by implication or otherwise under any patent or patent rights of RFMD. RFMD reserves the right to change component circuitry, recommended application circuitry and specifications at any time without prior notice.

\*Note: No RF Drive

\*\*Note: With specified application circuit

Operation of this device beyond any one of these limits may cause permanent damage. For reliable continuous operation, the device voltage and current must not exceed the maximum operating values specified in the table on page one.

Bias Conditions should also satisfy the following expression:

$$I_D V_D < (T_J - T_L) / R_{TH+JH}$$

## Typical Performance 3.3GHz to 3.8GHz App Circuit ( $V_{CC}=5V$ , $I_{CC}=600mA$ , 802.11g 54mb/s 64QAM)

Parameter	Units	3.3GHz	3.4GHz	3.5GHz	3.6GHz	3.7GHz	3.8GHz
Gain @ $P_{OUT}=26dBm$	dB	35.2	35.2	35.2	34.5	32.8	30.0
P1dB	dBm	34.4	34.3	34.3	34.1	33.9	33.0
$P_{OUT}$ @ 2.5% EVM	dBm	26.5	26.5	26.5	26.5	26.0	26.0
Current @ $P_{OUT}$ 2.5% EVM	mA	769	769	752	750	750	720
Input Return Loss	dB	14	17	19	21	19	16
Output Return Loss	dB	10.0	10.5	10.0	9.0	9.0	8.0
Step Attenuation ( $V_{PC2}=0V$ )	dB	23.0	22.0	22.0	21.0	18.0	15.0

## Simplified Device Schematic

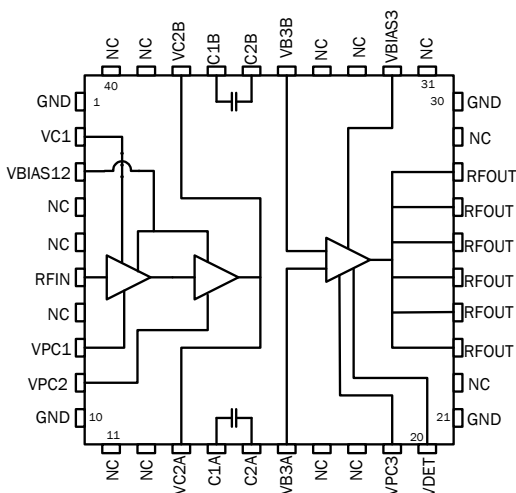

Measured 3.3GHz to 3.8GHz Application Circuit Data ( $V_{CC}=V_{PC}=5.0V$   $I_Q=600mA$ ,  $T=25^\circ C$ )

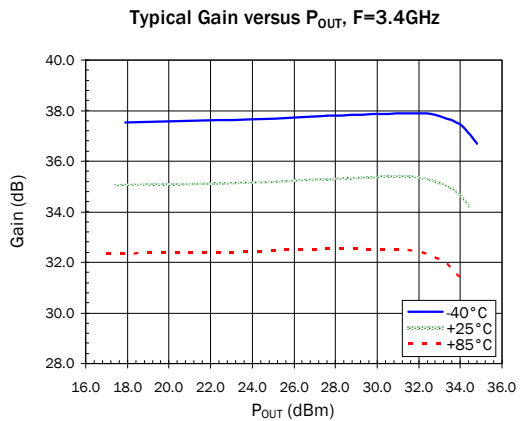
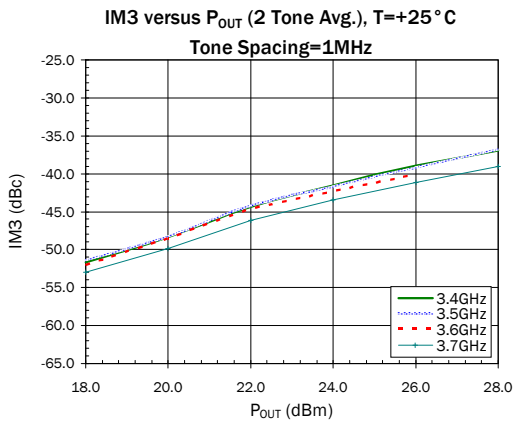
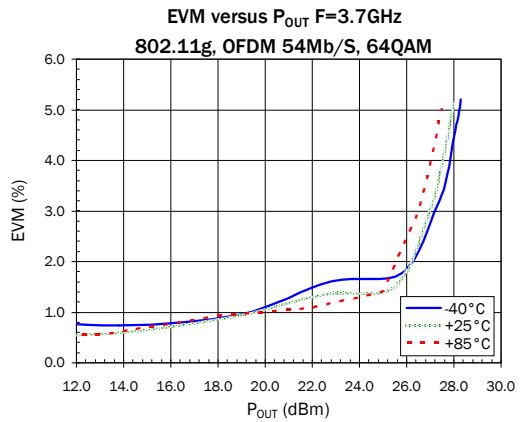
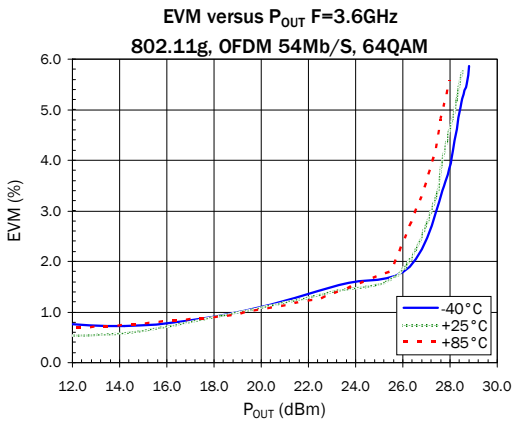
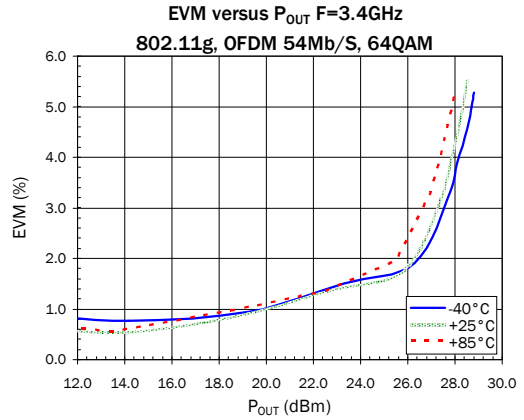
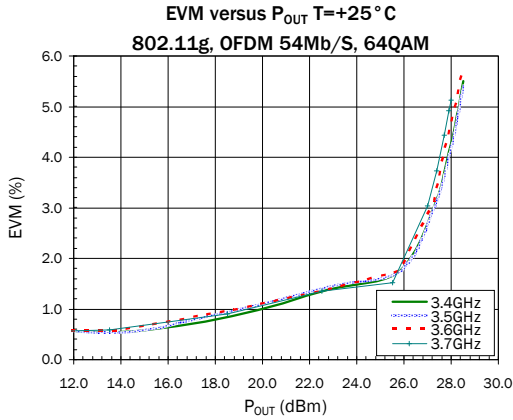

Measured 3.3GHz to 3.8GHz Application Circuit Data ( $V_{CC}=V_{PC}=5.0V$   $I_Q=600mA$ ,  $T=25^\circ C$ )

Typical Gain versus  $P_{OUT}$ ,  $F=3.6GHz$

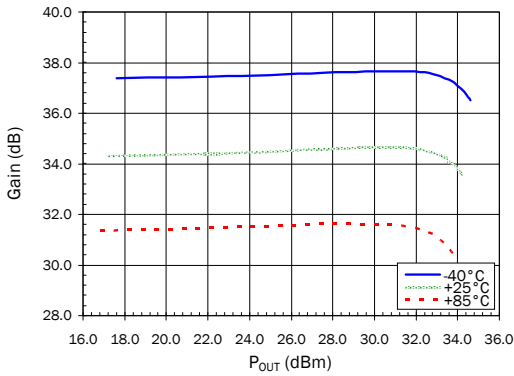

Typical Gain versus  $P_{OUT}$ ,  $F=3.7GHz$

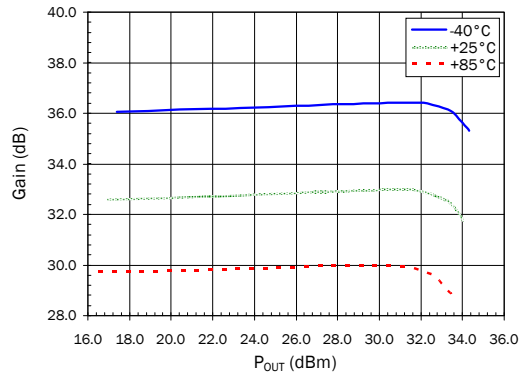

Narrowband S11 - Input Return Loss

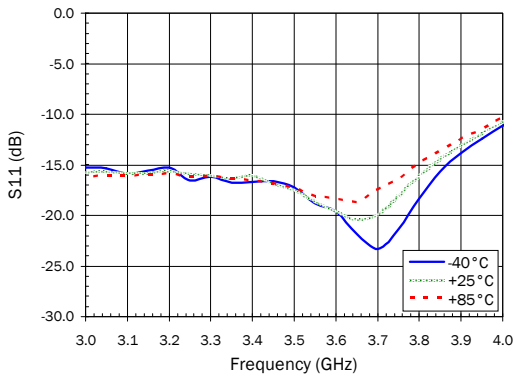

Narrowband S12 - Reverse Isolation

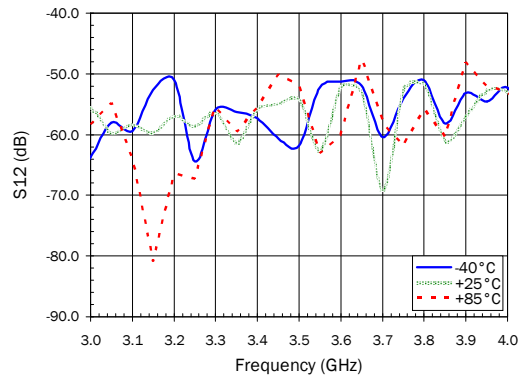

Narrowband S21 - Forward Gain

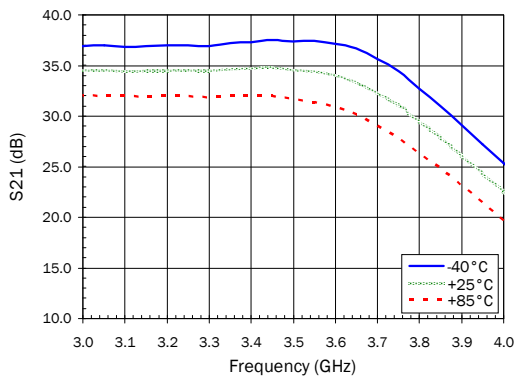

Narrowband S22 - Output Return Loss

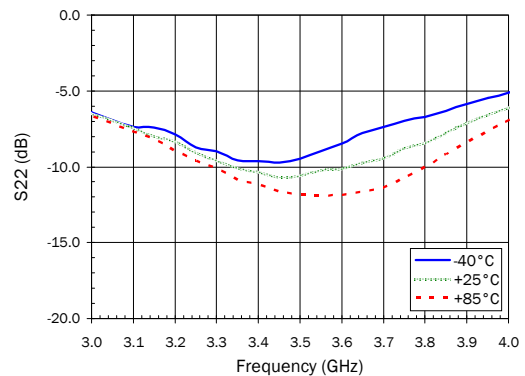

Measured 3.3GHz to 3.8GHz Application Circuit Data ( $V_{CC}=V_{PC}=5.0V$   $I_Q=600mA$ ,  $T=25^\circ C$ )

DC Supply Current versus  $P_{OUT}$ ,  $T=25^\circ C$

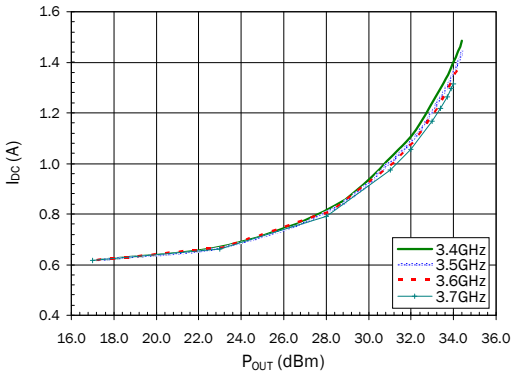

DC Supply Current versus  $P_{OUT}$ ,  $F=3.5GHz$

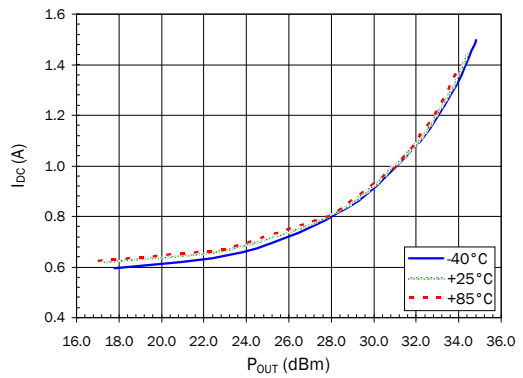

Noise Figure versus Frequency,  $T=+25^\circ C$

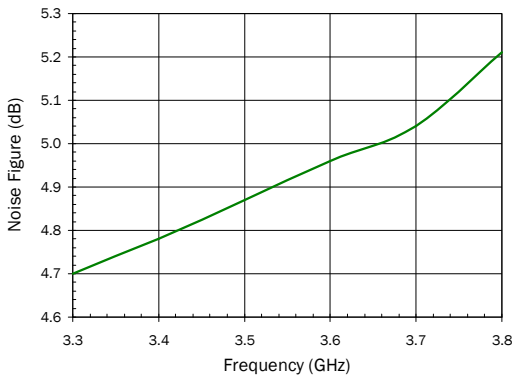

RF Power Detector ( $V_{DET}$ ) versus  $P_{OUT}$ ,  $F=3.4GHz$

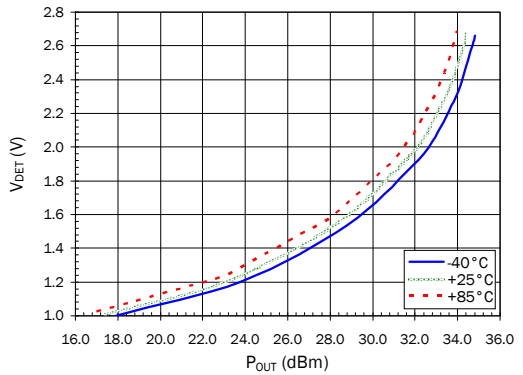

RF Power Detector ( $V_{DET}$ ) versus  $P_{OUT}$ ,  $F=3.7GHz$

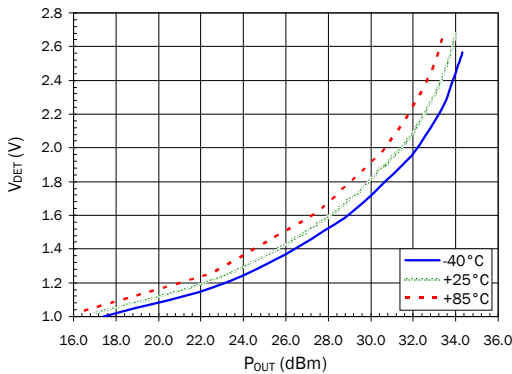

$I_{CQ}$  versus  $V_{PC}$ ,  $V_{CC}=5V$ , Swept  $V_{PC}$   
See App. Circuit pg. 8 for  $V_{PC}$  resistor value used

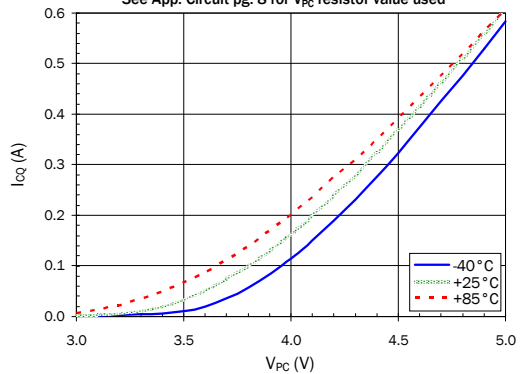

Measured 3.3GHz to 3.8GHz Application Circuit Data ( $V_{CC}=V_{PC}=5.0V$   $I_Q=600mA$ ,  $T=25^\circ C$ )

**Broadband S11 - Input Return Loss**

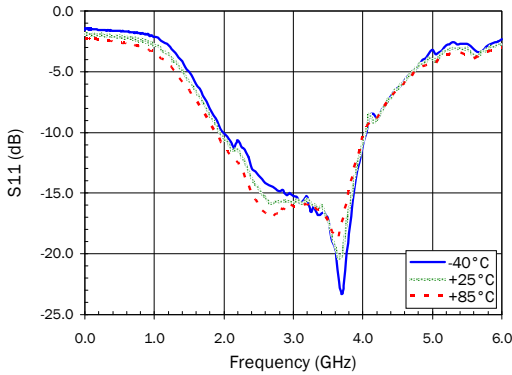

**Broadband S12 - Reverse Isolation**

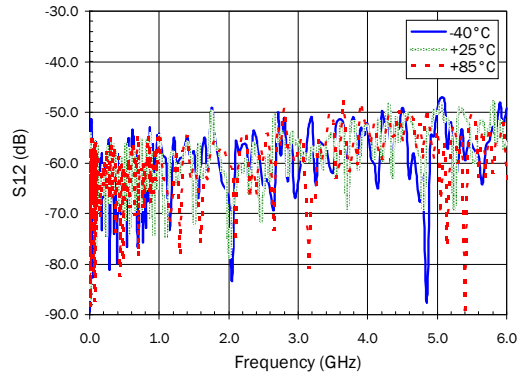

**Broadband S21 - Forward Gain**

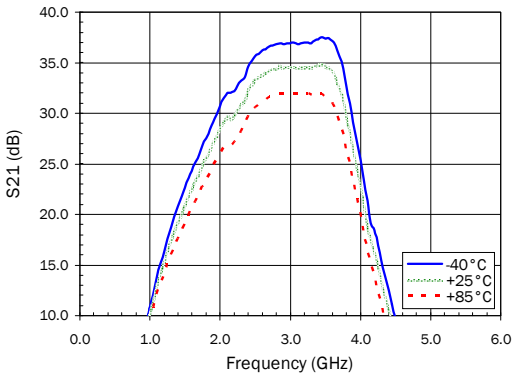

**Broadband S22 - Output Return Loss**

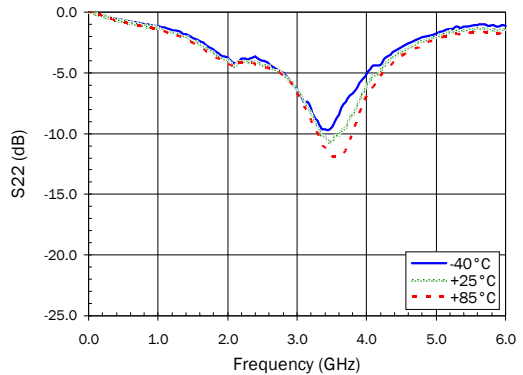

**20dB Step Attenuator Function Gain Delta versus Temperature**

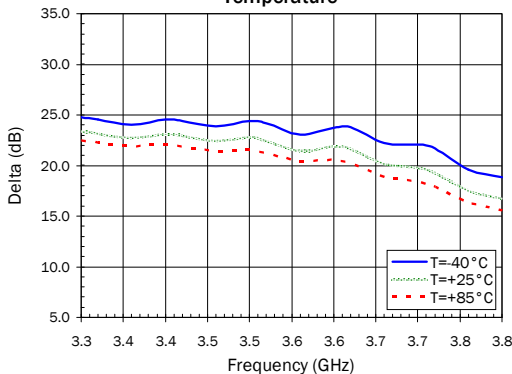

Pin	Function	Description
5, 7, 11, 12, 17, 18, 22, 29, 31, 33, 34, 39, 40	NC	These are no connect (NC) pins and are not wired inside the package. It is recommended to connect them as shown in the application circuit to achieve the stated performance.
1, 10, 21, 30	GND	These pins are internally grounded inside the package to the backside ground paddle. It is recommended to also ground them external to the package to achieve the specified performance.
2	VC1	This is the collector of the first stage.
3	VBIAS12	This is the supply voltage for the active bias circuit of the 1st and 2nd stages.
4	NC	This pin is not connected inside the package, but it is recommended to connect it to GND to achieve the specified performance.
6	RF IN	This is the RF input pin. It is DC grounded inside the package. Do not apply DC voltage to this pin.
8	VPC1	Power up/down control pin for the 1st stage. An external series resistor is required for proper setting of bias levels depending on control voltage. The voltage on this pin should never exceed the voltage on pin 3 by more than 0.5V unless the supply current from pin 3 is limited < 10mA.
9	VPC2	Power up/down control pin for the 2nd stage. Power down VPC2 < 1V for step attenuator function enable. An external series resistor is required for proper setting of bias levels depending on control voltage. The voltage on this pin should never exceed the voltage on pin 3 by more than 0.5V unless the supply current from pin 3 is limited < 10mA.
13, 38	VC2A, VC2B	These two pins are connected internal to the package to the 2nd stage collector. To achieve specified performance, the layout of these pins should match the Recommended Land Pattern.
14, 15, 36, 37	C1A, C2A C1B, C2B	These pins have capacitors across them internal to the package as shown in the below schematic. They are used as tuning and RF coupling elements between the 2nd and 3rd stage.
16, 35	VB3A, VB3B	These are the connections to the base of the 3rd stage output device. To achieve specified performance, the layout of these pins should match the Recommended Land Pattern.
19	VPC3	Power up/down control pin for the 3rd stage. An external series resistor is required for proper setting of bias levels depending on control voltage. The voltage on this pin should never exceed the voltage on pin 32 by more than 0.5V unless the supply current from pin 33 is limited < 10mA.
20	VDET	This is the output port for the power detector. It samples the power at the input of the 3rd stage.
23-28	RFOUT	These are the RF output pins and DC connections to the 3rd stage collector.
32	VBIAS3	This is the supply voltage for the active bias circuit of the 3rd stage.

## Package Drawing

Dimensions in millimeters

Refer to drawing posted at [www.rfmd.com](http://www.rfmd.com) for tolerances.

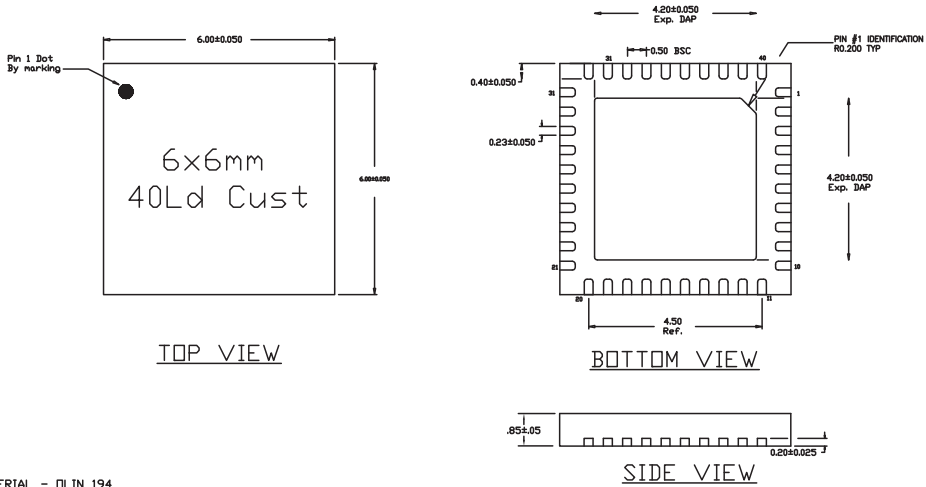

### NOTES:

1. LF MATERIAL - OLIN 194
2. LF METAL THICKNESS - .20 mm
3. MOLD COMPOUND - 94V0 GREEN COMPLIANT
4. LEAD FINISH Sn/Pb - BASIC PN  
100% MATTE Sn "Z" OPTION

### Part Symbolization

The part will be symbolized with "SZM-3066Z" to designate it as RoHs green compliant product. Marking designator will be on the top surface of the package.



**3.3GHz to 3.8GHz Evaluation Board Schematic**

For  $V_{CC}=V+=V_{PC}=5.0V$

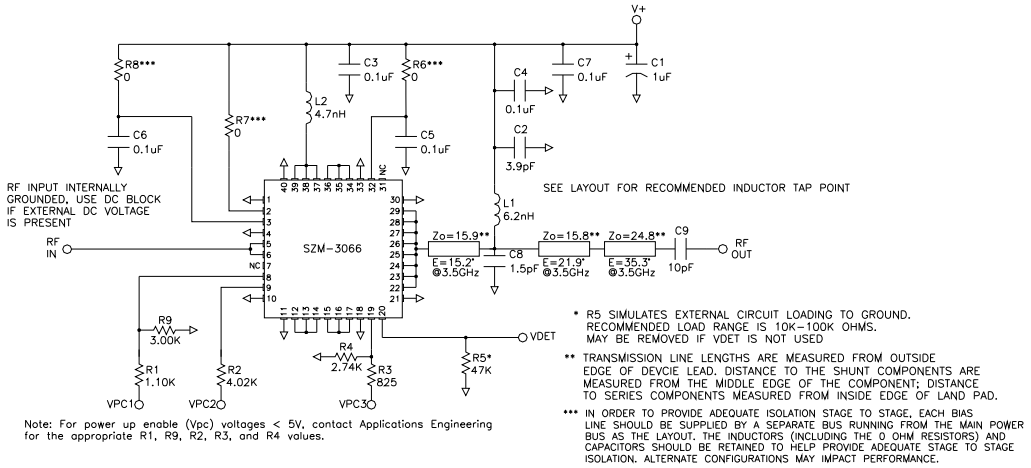

## 3.3GHz to 3.8GHz Evaluation Board Layout and Bill of Materials

For  $V_{CC}=V+=V_{PC}=5.0V$

Board Material GETEK, 10mil thick, Dk=3.9, 2oz. copper

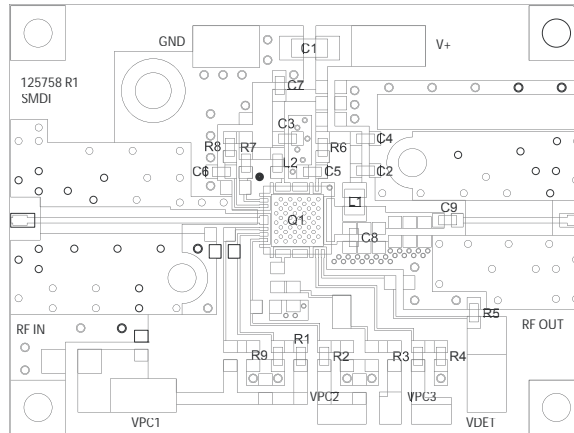

### Bill of Materials

Desg	Description	Notes
Q1	SZM-3066Z	6mmx6mm QFN
R1	1.0K $\Omega$ , 0603 1%	0402 may be used
R2	4.02K $\Omega$ , 0603 1%	0402 may be used
R3	825 $\Omega$ , 0603 1%	0402 may be used
R4	2.74K $\Omega$ , 0603 1%	0402 may be used
R5	47K $\Omega$ , 0603	0402 may be used
R6, 7, 8	0 $\Omega$ , 0603	0402 may be used
R9	3kW, 0603 1%	0402 may be used
C1	1 $\mu$ F 16V MLCC CAP	Tantalum ok for EVM performance. Use MLCC type for best IM3 levels.
C2	3.9pF CAP, 0603	NPO, ROHM MCH185A3R9DK or equivalent
C3, 4, 5, 6, 7	0.1 $\mu$ F CAP, 0603	X7R 0402 ok, ROHM MCH182CN104K or equivalent
C8	1.5pF CAP, 0603	NPO, low ESR, ATC 600S1RCW250 or equivalent
C9	10pF CAP, 0603	NPO, low EST, ATC 600S100JW250 or equivalent
L1	6.2nH IND 0805	Coilcraft 0805HQ - 6N2XJBB
L2	4.7nH IND, 0603	TOKO 0603 - LL1608FH4N7J

**Recommended Metal Land Pattern**

Dimensions in millimeters

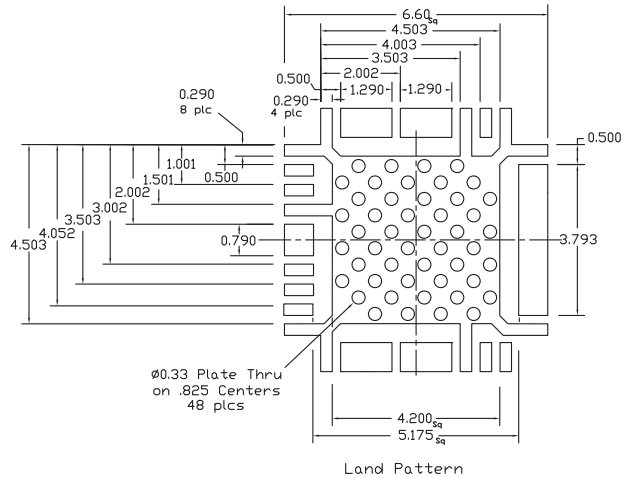

Land Pattern

**Recommended PCB Soldermask for Land Pattern**

Dimensions in millimeters

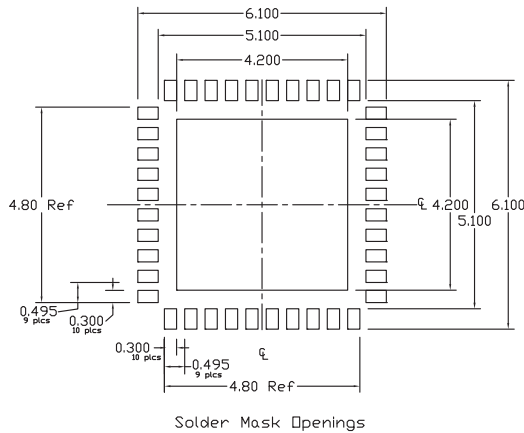

Solder Mask Openings

## Ordering Information

Ordering Code	Description
SZM3066ZSQ	Standard 25 piece bag
SZM3066ZSR	Standard 100 piece reel
SZM3066Z	Standard 1000 piece reel
SZM3066ZPCK-EVB1	Evaluation Board 3.3GHz to 3.8GHz Tune and 5 loose sample pieces

## X-ON Electronics

Largest Supplier of Electrical and Electronic Components

*Click to view similar products for [RF Amplifier](#) category:*

*Click to view products by [Qorvo](#) manufacturer:*

Other Similar products are found below :

[A82-1](#) [BGA622H6820XTSA1](#) [BGA 728L7 E6327](#) [BGB719N7ESDE6327XTMA1](#) [HMC397-SX](#) [HMC405](#) [HMC561-SX](#) [HMC8120-SX](#)  
[HMC8121-SX](#) [HMC-ALH382-SX](#) [HMC-ALH476-SX](#) [SE2433T-R](#) [SMA3101-TL-E](#) [SMA39](#) [A66-1](#) [A66-3](#) [A67-1](#) [LX5535LQ](#) [LX5540LL](#)  
[MAAM02350](#) [HMC3653LP3BETR](#) [HMC549MS8GETR](#) [HMC-ALH435-SX](#) [SMA101](#) [SMA32](#) [SMA411](#) [SMA531](#) [SST12LP19E-QX6E](#)  
[WPM0510A](#) [HMC5929LS6TR](#) [HMC5879LS7TR](#) [HMC1126](#) [HMC1087F10](#) [HMC1086](#) [HMC1016](#) [SMA1212](#) [MAX2689EWS+T](#)  
[MAAMSS0041TR](#) [MAAM37000-A1G](#) [LTC6430AIUF-15#PBF](#) [SMA70-2](#) [SMA4011](#) [A231](#) [HMC-AUH232](#) [LX5511LQ](#) [LX5511LQ-TR](#)  
[HMC7441-SX](#) [HMC-ALH310](#) [XD1001-BD-000V](#) [A4011](#)