

TAT6254B

Fiber To The Home RF Amplifier 47–1000 MHz

Applications

- High dynamic range FTTH
- RFoG (Radio Frequency over Glass) and GPON FTTH
- Multi Dwelling Unit TIA
- Mini-node



Product Features

- Pin compatible with the TAT6254C
- Single 12 V configuration
- Low Noise 3.0 pA/rHz Equivalent Input Noise
- 14 dBmV/channel RF output at 55.25 MHz
- Both RF and Optical AGC designs available, continuously variable
- Low power consumption, 1.2 Watts at 12 V
- -12 to -2 dBm optical input range
- Linearity better than -62 dBc CSO and -62 dBc CTB

General Description

The TriQuint TAT6254B FTTP SFU Video Receiver provides a low noise analog interface to CATV receivers and optical triplexers. The TAT6254B is intended for use in single family unit (SFU) analog video fiber to the premise (FTTP) applications.

The TAT6254B exhibits low input noise and distortion that provides performance margin critical to meeting stringent FTTP link requirements, particularly those with all QAM channel loading. It runs on a single 12 volt supply, eliminating the need for an extra ONU power supply. The TAT6254B provides automatic gain control (AGC) to maintain a constant +14 dBmV/ch output to ensure consistent video quality and ease of design. The TAT6254B is fabricated using 6-inch GaAs pHEMT technology to optimize performance and cost. The TAT6254B is pin and functionally compatible with the TAT6254C, though it has significantly increased gain and lower noise for all or near-all QAM deployments.

Functional Block Diagram

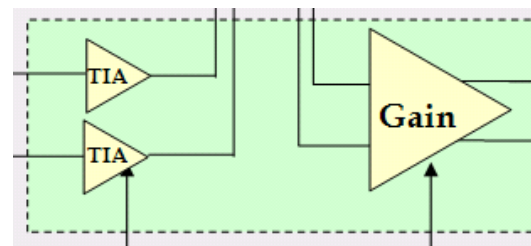

Pin Configuration

Pin #	Symbol
1	TIA IN A
2,4	BIAS 1
3,13	NC
5	TIA IN B
6	BIAS ADJ B
7	TIA OUT B
8, 18	BIAS 2
9	PA IN B
11, 12	PA OUT B
14, 15	PA OUT A
17	PA IN A
19	TIA OUT A
20	BIAS ADJ A
EPAD	GND

Ordering Information

Part No.	Description
TAT6254B	CATV FTTH pHEMT amplifier
TAT6254B-EB	Evaluation Board

Standard T/R size = 2500 pieces on a 13" reel.

TAT6254B

Fiber To The Home RF Amplifier 47–1000 MHz



Specifications

Absolute Maximum Ratings

Parameter	Rating
Storage Temperature	-60 to +150 °C
Device Voltage, V_{DD}	+15 V
Thermal Resistance (jnc. to case) θ_{jc}	19 °C/W

Operation of this device outside the parameter ranges given above may cause permanent damage.

Recommended Operating Conditions

Parameter	Min	Typ	Max	Units
V_{DD}		12		V
T_J (for $>10^6$ hours MTF)			150	°C

Electrical specifications are measured at specified test conditions. Specifications are not guaranteed over all recommended operating conditions.

Electrical Specifications

(Per Applications Circuit Herein)

Parameter	Conditions	Min	Typical	Max	Units
Operational Frequency Range		47		1000	MHz
RF Gain at 553.25 MHz	See Note 1.		38		dB
Gain Flatness			1.0		dB
Tilt	See Note 2.		4		dB
Equivalent Input Noise			3.0		pA/rtHz
RF Output Level @ 55.25 MHz	See Notes 3 & 5.		14		dBmV/ch
Output Return Loss			16		dB
CSO	See Note 4.		-62		dBc
CTB	See Note 4.		-62		dBc
Gain Control Range	See Note 6.		33		dB
Power Supply Current @ 12V			100		mA

- 1) Gain = $20 \cdot \log(Z/75)$
- 2) From 47MHz to 1000MHz
- 3) AGC using 3.3%/ch OMI, output level fixed by external AGC
- 4) 80 channels analog NTSC
- 5) Uses 4:1 output transformer
- 6) With suggested RF AGC application circuit, 25dB with Optical AGC application circuit

Optical Input and Triplexer Requirements

Parameter	Conditions	Min	Typical	Max	Units
Optical Input Power		-12		-2	dBm
Optical Modulation Index			3.3		%/ch
Triplexer 1550 nm PIN Responsivity			0.875		mA/mW
Triplexer 1550 nm PIN Capacitance				0.9	pF

TAT6254B

Fiber To The Home RF Amplifier 47–1000 MHz



Application Board Typical Performance

$V_{DD} = +12\text{ V}$, $I_{DD} = 100\text{ mA}$ (at 25 °C), Temperatures are case temp

Gain Over AGC Voltage

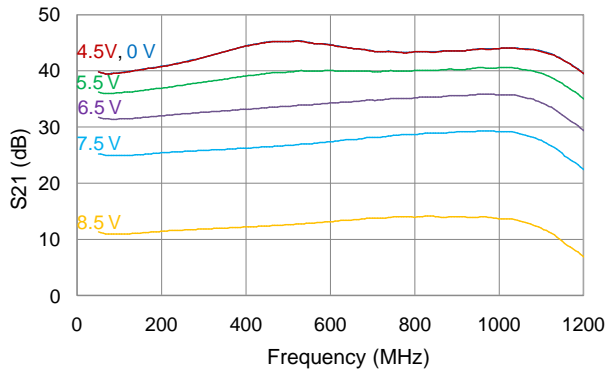

Output Return Loss

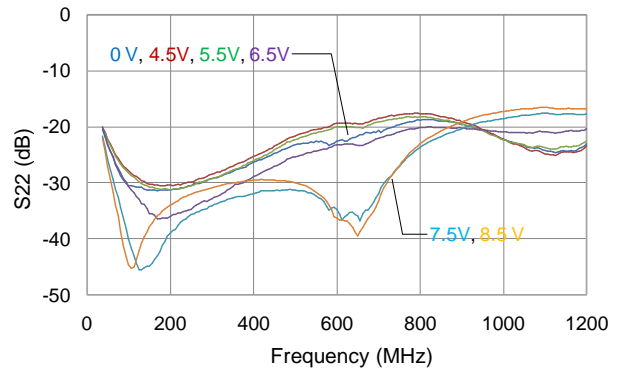

Equivalent Input Noise

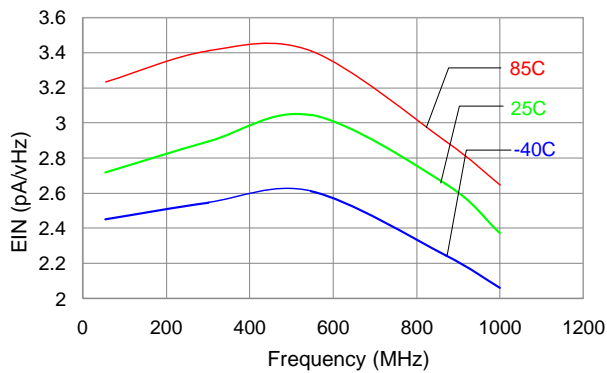

Carrier to Noise Ratio

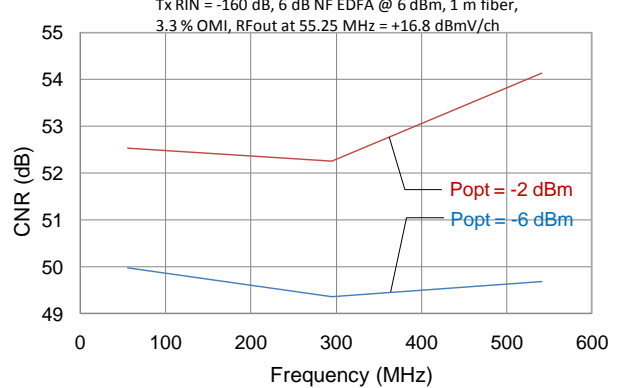

CTB

80 Channels NTSC, 16.8 dBmV/ch at 55.25 MHz, $P_{in} = -2\text{ dBm}$

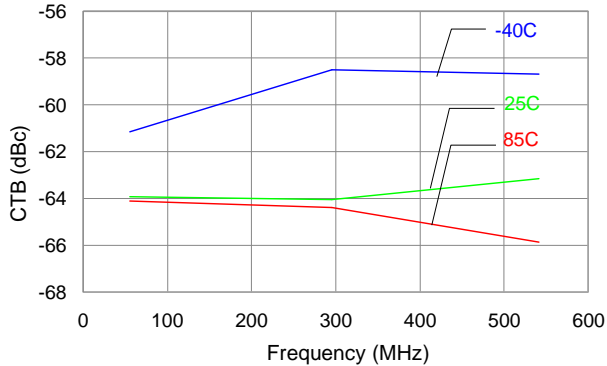

CSO

80 Channels NTSC, 16.8 dBmV/ch at 55.25 MHz, $P_{in} = -2\text{ dBm}$

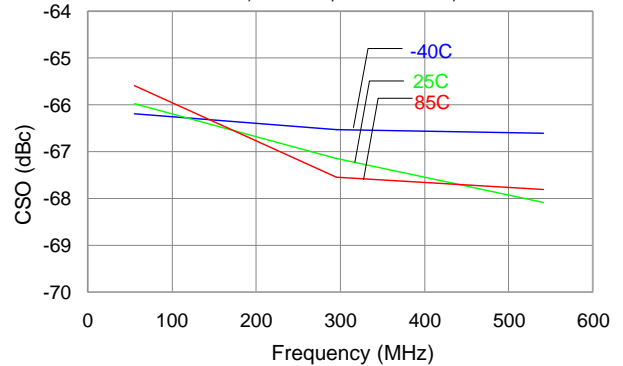

TAT6254B

Fiber To The Home RF Amplifier 47–1000 MHz

Detailed Device Description

The TAT6254B integrates two low noise high gain trans-impedance amplifiers in a differential configuration followed by an output amplifier. It provides a low input impedance to minimize the effects of photodiode capacitances and stray impedance affects on gain flatness.

The TAT6254B is fabricated using high gain Gallium Arsenide pHEMT technology developed for high-volume commercial markets. It provides improved gain and noise compared to older MESFET technologies and lower gain pHEMT technologies.

The TAT6254B was designed as a general purpose FTTP receiver. It allows users wide flexibility in setting gain, tilt, and bias levels to best meet the requirements posed by different operators and architectures. The TAT6254B provides the flexibility to address high levels of gain required by GPON and RFoG architectures. Designers can easily modify external circuit values to enable wider optical input ranges, such as needed in newer high digital content FTTH architectures.

Gain control is accommodated with a low cost external PIN diode circuit placed between the input trans-impedance amplifier and the output amplifier. This helps reduce the die size of the TAT6254B and provides for excellent PIN diode distortion characteristics over a continuous control range. RF AGC, Figure 1, provides 33 dB range. The optical AGC solution, Figure 2, provides 25 dB range, using fewer PIN diodes.

There are no discrete steps over the full gain control range which eliminates the possibility of bit errors from a stepped or switched AGC approach.

RF AGC Solution, Figure 1

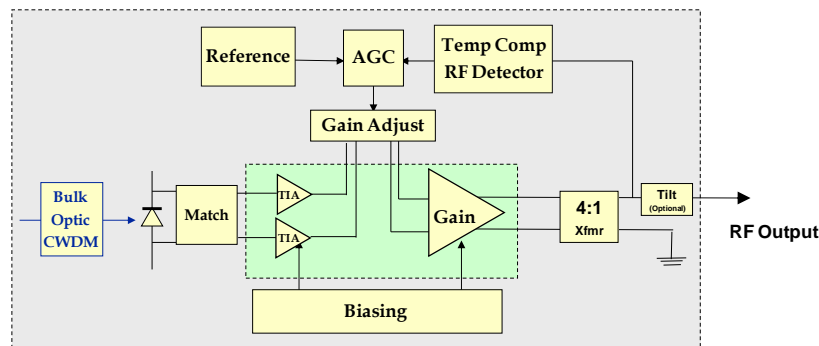

Optical AGC Solution, Figure 2

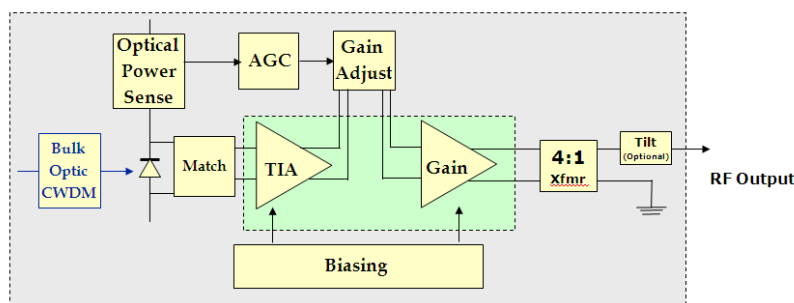

For further information email sicapplication.engineering@tqs.com.

TAT6254B

Fiber To The Home RF Amplifier 47–1000 MHz



Application Schematic

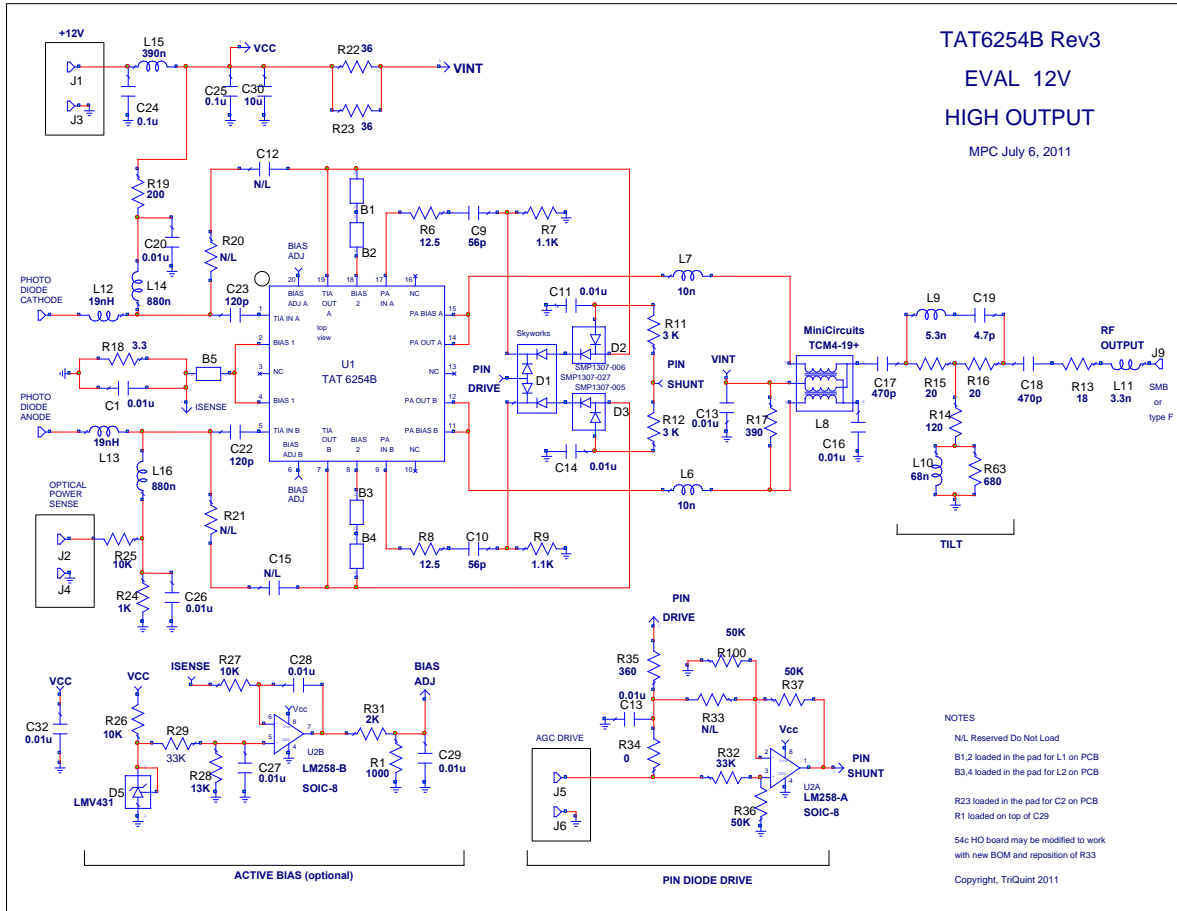

Pin Description

Pin	Symbol	Description
1	TIA IN A	Input to trans-impedance amplifier A
2,4	BIAS 1	Bias Port
3,13	NC	No Connect
5	TIA IN B	Input to trans-impedance amplifier B
6	BIAS ADJ B	Bias adjustment for trans-impedance amplifier B
7	TIA OUT B	Output of trans-impedance amplifier B
8, 18	BIAS 2	Bias port
9	PA IN B	Input to post-amplifier B
11, 12	PA OUT B	Output of post amplifier B

TAT6254B

Fiber To The Home RF Amplifier 47–1000 MHz



Pin	Symbol	Description
14, 15	PA OUT A	Output of post amplifier A
17	PA IN A	Input to post amplifier A
19	TIA OUT A	Output of trans-impedance amplifier A
20	BIAS ADJ A	Bias adjustment for trans-impedance amplifier A
EPAD	GND	Ground

Mechanical Information

Package Information and Dimensions

This package is lead-free/RoHS-compliant. It is compatible with both lead-free (maximum 260 °C reflow temperature) and lead (maximum 245 °C reflow temperature) soldering processes.

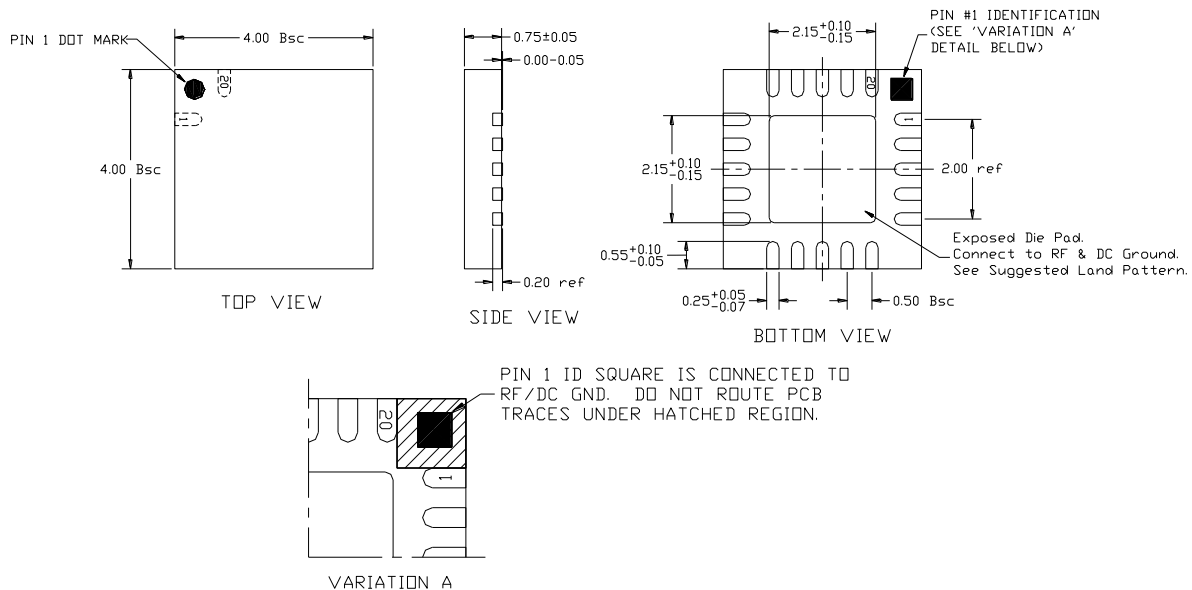

Pin #1 Identification Detail

Mounting Configuration

All dimensions are in millimeters. Angles are in degrees.

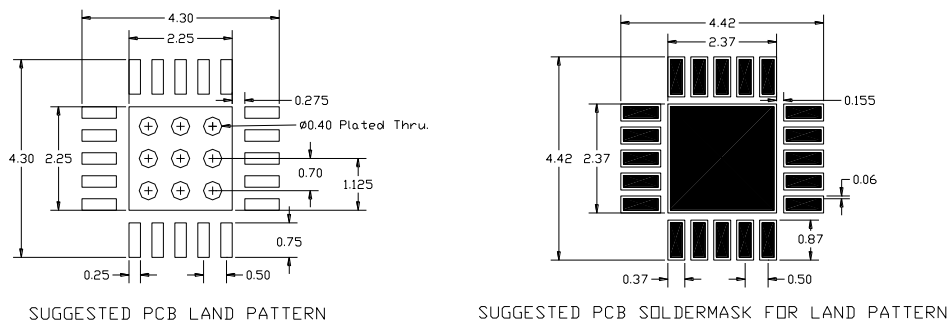

TAT6254B

Fiber To The Home RF Amplifier 47–1000 MHz



Product Compliance Information

ESD Information



Caution! ESD-Sensitive Device

ESD Rating: Class 1A
Value: Passes ≥ 250 V min.
Test: Human Body Model (HBM)
Standard: JEDEC Standard JESD22-A114

ESD Rating: Class IV
Value: Passes ≥ 1000 V min.
Test: Charged Device Model (CDM)
Standard:

MSL Rating

The part is rated Moisture Sensitivity Level 1 at 260°C per JEDEC standard IPC/JEDEC J-STD-020.

Solderability

Compatible with the latest version of J-STD-020, Lead free solder, 260°

This part is compliant with EU 2002/95/EC RoHS directive (Restrictions on the Use of Certain Hazardous Substances in Electrical and Electronic Equipment).

This product also has the following attributes:

- Lead Free

Contact Information

For the latest specifications, additional product information, worldwide sales and distribution locations, and information about TriQuint:

Web: www.triquint.com
Email: info-sales@tqs.com

Tel: +1.707.526.4498
Fax: +1.707.526.1485

For technical questions and application information:

Email: sicapplication.engineering@tqs.com

Important Notice

The information contained herein is believed to be reliable. TriQuint makes no warranties regarding the information contained herein. TriQuint assumes no responsibility or liability whatsoever for any of the information contained herein. TriQuint assumes no responsibility or liability whatsoever for the use of the information contained herein. The information contained herein is provided "AS IS, WHERE IS" and with all faults, and the entire risk associated with such information is entirely with the user. All information contained herein is subject to change without notice. Customers should obtain and verify the latest relevant information before placing orders for TriQuint products. The information contained herein or any use of such information does not grant, explicitly or implicitly, to any party any patent rights, licenses, or any other intellectual property rights, whether with regard to such information itself or anything described by such information.

TriQuint products are not warranted or authorized for use as critical components in medical, life-saving, or life-sustaining applications, or other applications where a failure would reasonably be expected to cause severe personal injury or death.

X-ON Electronics

Largest Supplier of Electrical and Electronic Components

Click to view similar products for [RF Amplifier](#) category:

Click to view products by [Qorvo](#) manufacturer:

Other Similar products are found below :

[A82-1](#) [BGA622H6820XTSA1](#) [BGA 728L7 E6327](#) [BGB719N7ESDE6327XTMA1](#) [HMC397-SX](#) [HMC405](#) [HMC561-SX](#) [HMC8120-SX](#)
[HMC8121-SX](#) [HMC-ALH382-SX](#) [HMC-ALH476-SX](#) [SE2433T-R](#) [SMA3101-TL-E](#) [SMA39](#) [A66-1](#) [A66-3](#) [A67-1](#) [A81-2](#) [LX5535LQ](#)
[LX5540LL](#) [MAAM02350](#) [HMC3653LP3BETR](#) [HMC549MS8GETR](#) [HMC-ALH435-SX](#) [SMA101](#) [SMA32](#) [SMA411](#) [SMA531](#)
[SST12LP19E-QX6E](#) [WPM0510A](#) [HMC5929LS6TR](#) [HMC5879LS7TR](#) [HMC1087F10](#) [HMC1086](#) [HMC1016](#) [SMA1212](#) [MAX2689EWS+T](#)
[MAAMSS0041TR](#) [MAAM37000-A1G](#) [LTC6430AIUF-15#PBF](#) [SMA70-2](#) [SMA4011](#) [A231](#) [HMC-AUH232](#) [LX5511LQ](#) [LX5511LQ-TR](#)
[HMC7441-SX](#) [HMC-ALH310](#) [XD1001-BD-000V](#) [A4011](#)