

Product Description

Qorvo's TGA2214-CP is a packaged wideband power amplifier fabricated on Qorvo's QGaN15 0.15 μm GaN on SiC process. Operating from 2 to 18 GHz, the TGA2214-CP generates > 4 W saturated output power with a power-added efficiency of > 15 %, and > 14 dB large signal gain across the entire operational band.

The TGA2214-CP is offered in a 10-lead 15 x 15 mm bolt-down package. The package has a pure Cu base, offering superior thermal management. The TGA2214-CP is ideally suited to support, both in the commercial and the defense arenas, applications requiring either wideband or multi-band frequency performance.

Both RF ports have integrated DC blocking capacitors and are fully matched to 50 Ohms.



Product Features

- Frequency Range: 2 – 18 GHz
- P_{OUT} : > 36 dBm at $P_{IN} = 23$ dBm
- PAE: > 15 % CW at $P_{IN} = 23$ dBm
- Small Signal Gain: > 22 dB
- IM3: < -17 dBc at 30 dBm P_{OUT} /Tone
- Bias: $V_D = +22$ V, $I_{DQ} = 600$ mA, $V_G = -2.3$ V Typical
- Package Dimensions: 15.2 x 15.2 x 3.5 mm
- Package base is pure Cu offering superior thermal management

Functional Block Diagram

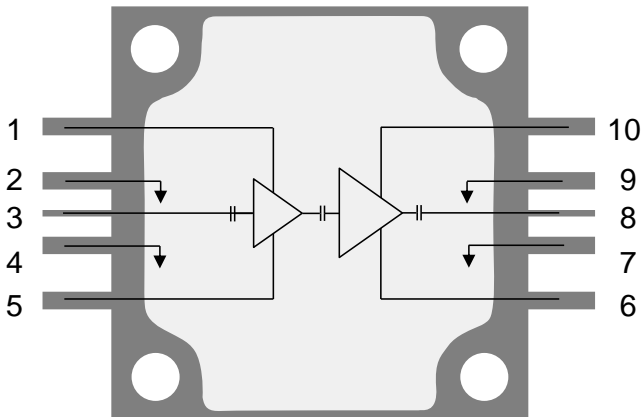

Applications

- Test Equipment
- Electronic Warfare
- Military and Commercial Radar

Ordering Information

Part No.	Description
TGA2214-CP	2 – 18 GHz 4 W GaN Power Amplifier
1119150	TGA2214-CP Evaluation Board



TGA2214-CP

2 – 18 GHz 4 W GaN Power Amplifier

Absolute Maximum Ratings

Parameter	Value / Range
Drain Voltage (V_D)	+29.5 V
Gate Voltage Range (V_G)	-5 to 0 V
Drain Current (I_D)	
1 st stage	0.5 A
2 nd stage	1.0 A
Forward Gate Current (I_G)	See page 8
Power Dissipation (P_{DISS}), 85 °C	31 W
Input Power, CW, 50 Ω , (P_{IN})	31 dBm
Input Power, CW, VSWR 3:1, $V_D = +30$ V, 85 °C, (P_{IN})	31 dBm
Channel Temperature (T_{CH})	275 °C
Soldering Temperature (30 Seconds)	260 °C
Storage Temperature	-55 to 150 °C

Operation of this device outside the parameter ranges given above may cause permanent damage. These are stress ratings only, and functional operation of the device at these conditions is not implied.

Recommended Operating Conditions

Parameter	Min	Typ.	Max	Units
Drain Voltage (V_D)		+22		V
Drain Current, (I_{DQ})		600		mA
Drain Current, RF (I_{D_Drive})	See chart page 6			mA
Gate Voltage Range (V_G)	-2 to -2.9			V
Gate Current, RF (I_{G_Drive})	See chart page 6			mA
T_{BASE} Range	-40		+85	°C

Electrical specifications are measured at specified test conditions. Specifications are not guaranteed over all recommended operating conditions.

Electrical Specifications

Parameter	Min	Typ	Max	Units
Operational Frequency Range	2	–	18	GHz
Small Signal Gain	–	> 22	–	dB
Input Return Loss	–	> 8	–	dB
Output Return Loss	–	> 11	–	dB
Output Power at $P_{IN} = 23$ dBm	–	> 36	–	dBm
Power Added Efficiency at $P_{IN} = 23$ dBm	–	> 15	–	%
IM3 ($P_{OUT} / \text{Tone} = 30$ dBm/Tone)	–	< -17	–	dBc
IM5 ($P_{OUT} / \text{Tone} = 30$ dBm/Tone)	–	< -29	–	dBc
Small Signal Gain Temperature Coefficient	–	-0.04	–	dB/°C
Output Power Temperature Coefficient (25 to 85 °C)	–	-0.005	–	dBm/°C
Recommended Operating Voltage	–	+22	+22	V

Test conditions unless otherwise noted: 25 °C, $V_D = +22$ V, $I_{DQ} = 600$ mA, $V_G = -2.3$ V Typ, CW.

Performance Plots – Small Signal

Conditions unless otherwise specified: $V_D = +22\text{ V}$, $I_{DQ} = 600\text{ mA}$, $V_G = -2.3\text{ V}$ Typical, CW.

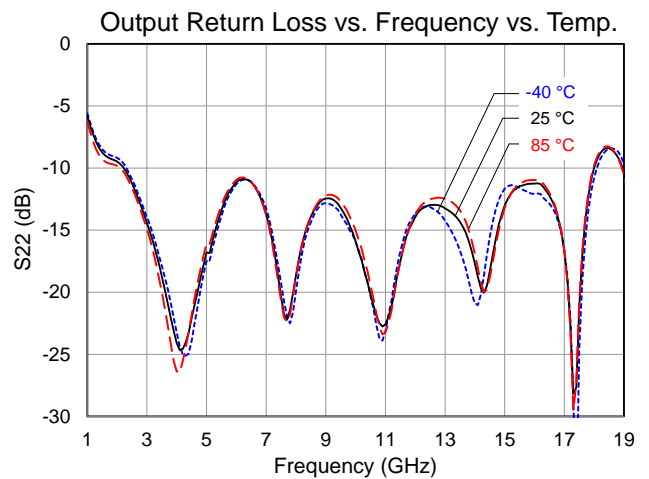
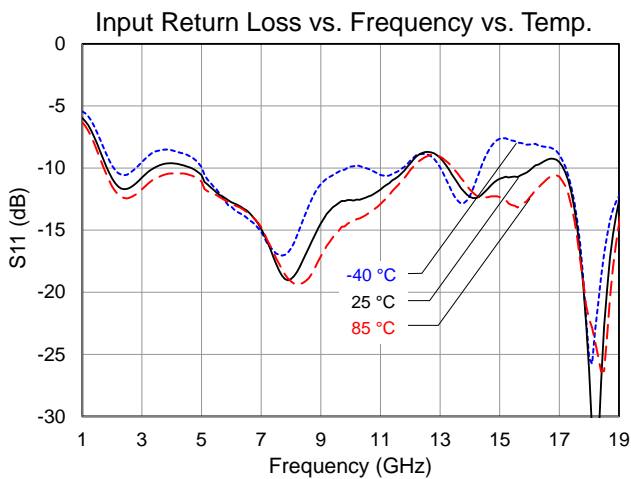
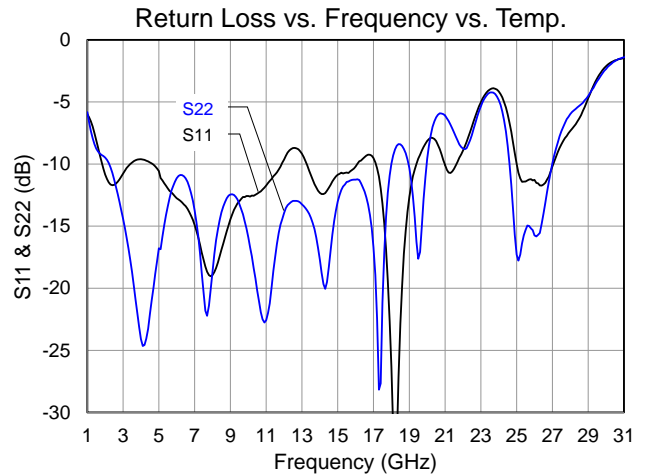
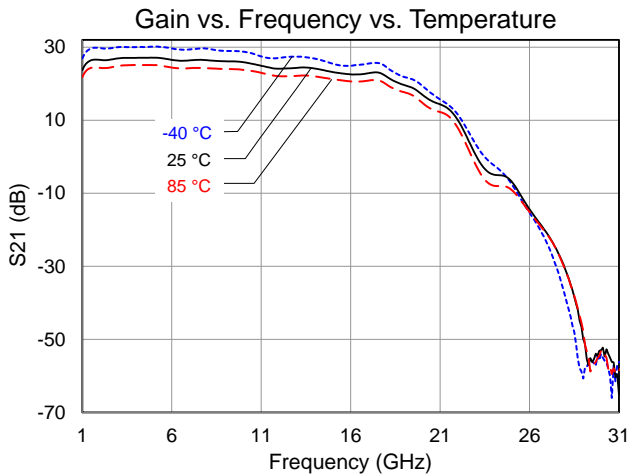
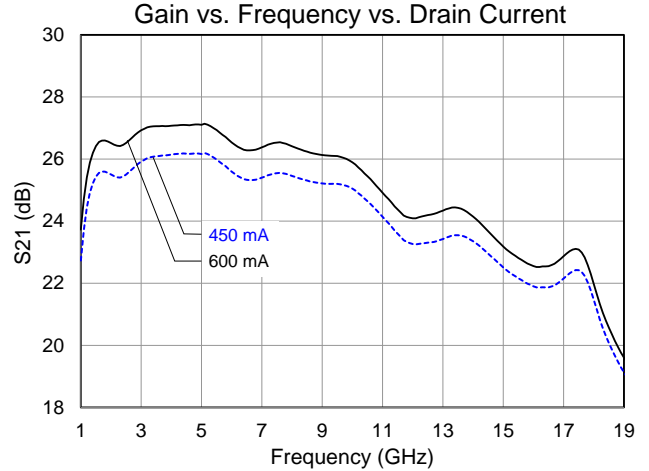
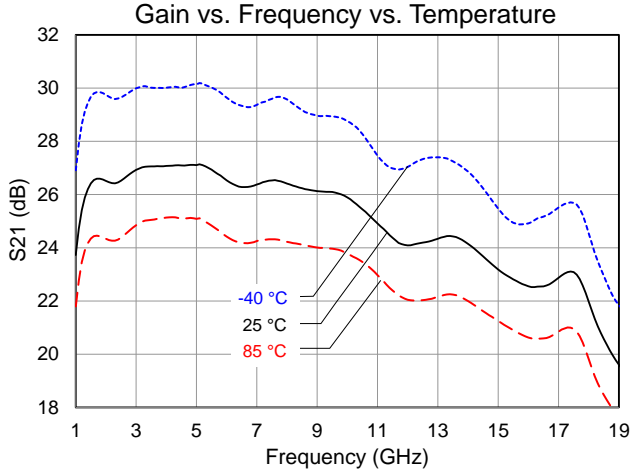

Performance Plots – Large Signal

Conditions unless otherwise specified: $V_D = +22\text{ V}$, $I_{DQ} = 600\text{ mA}$, $V_G = -2.3\text{ V}$ Typical, CW.

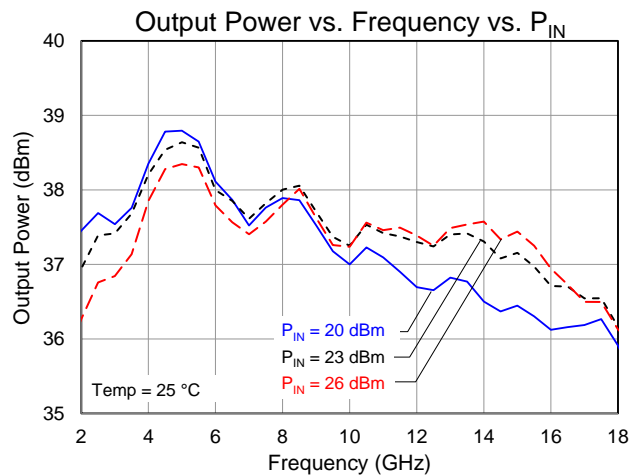
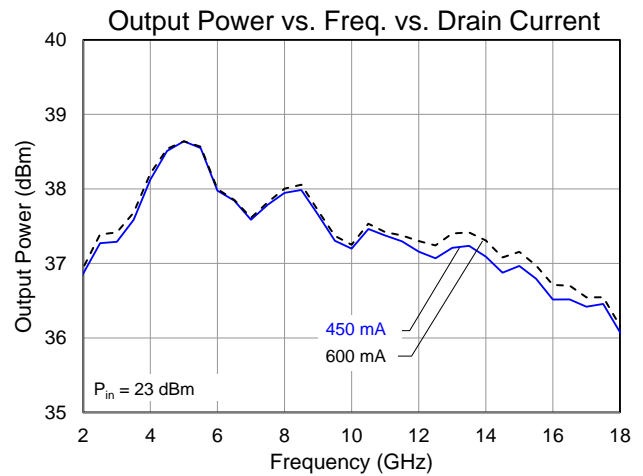
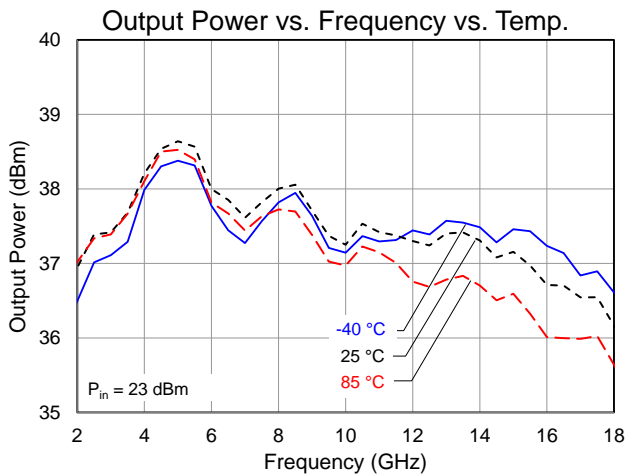
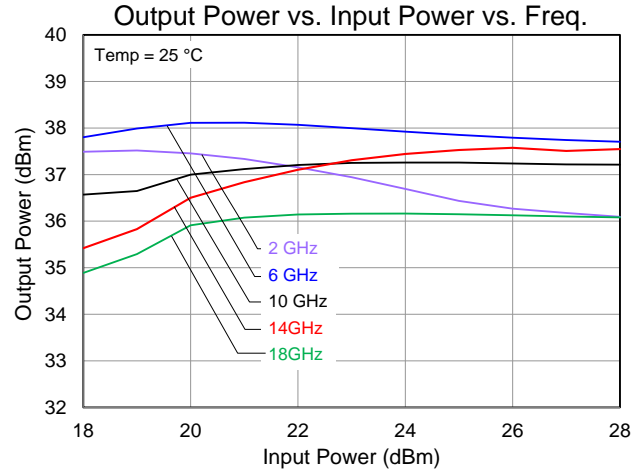
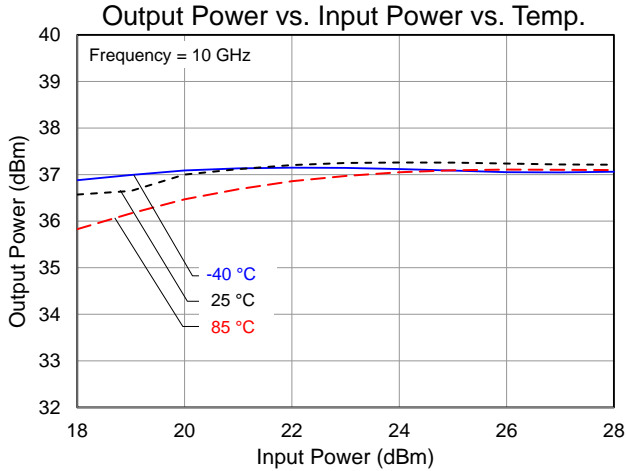

Performance Plots – Large Signal

Conditions unless otherwise specified: $V_D = +22\text{ V}$, $I_{DQ} = 600\text{ mA}$, $V_G = -2.3\text{ V}$ Typical, CW.

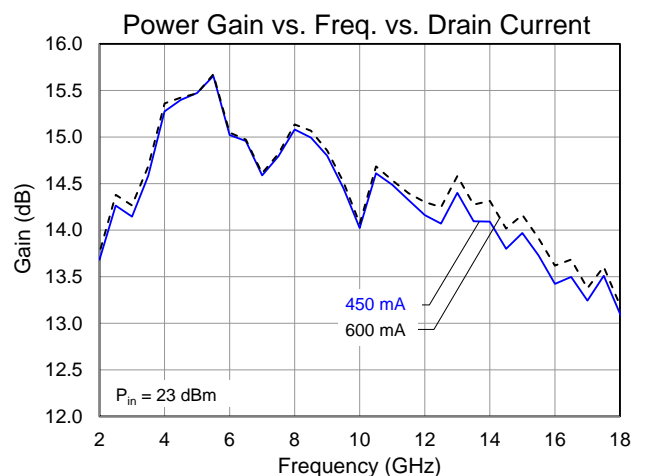
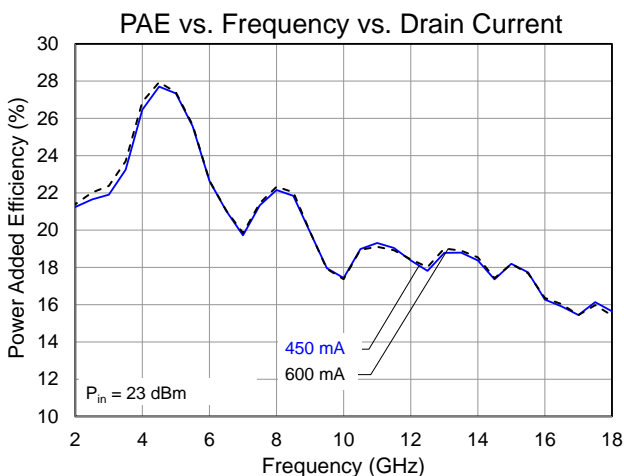
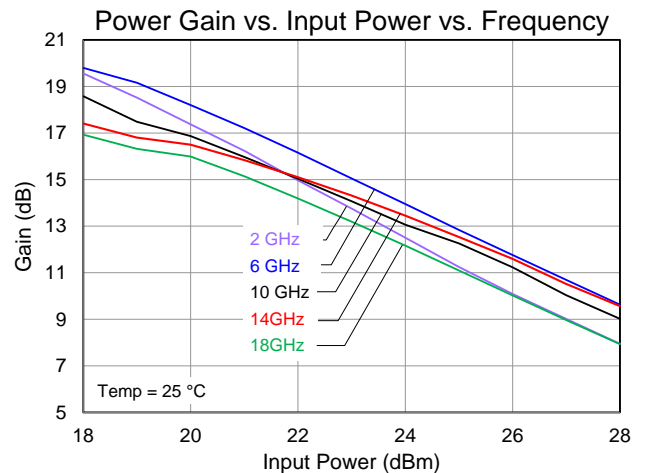
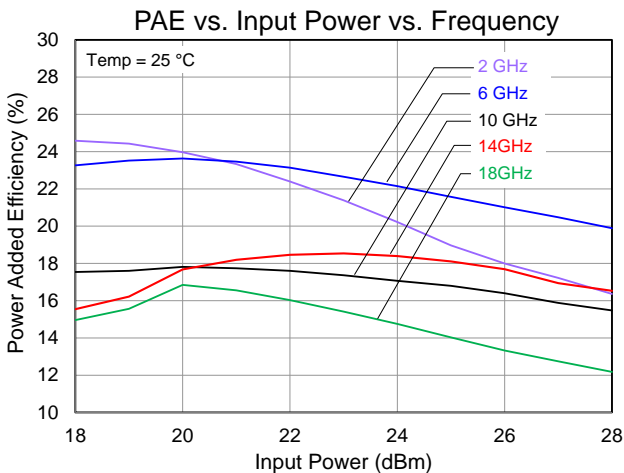
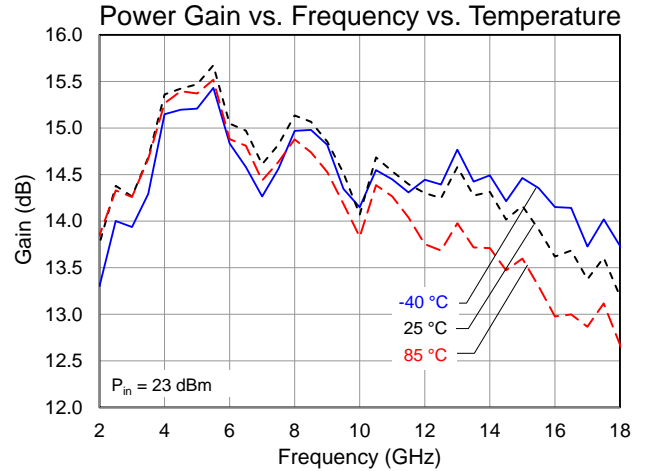
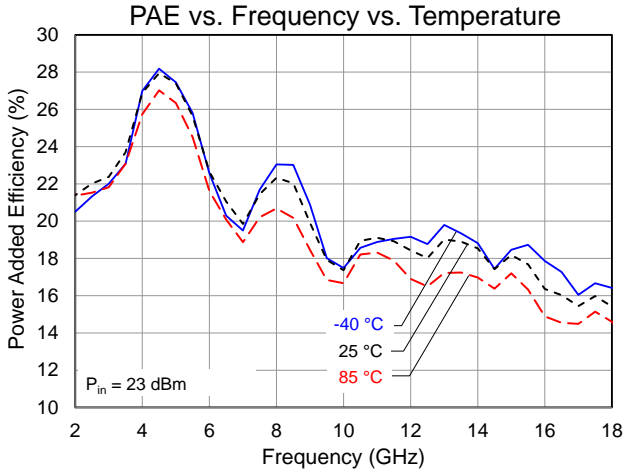

Performance Plots – Large Signal

Conditions unless otherwise specified: $V_D = +22\text{ V}$, $I_{DQ} = 600\text{ mA}$, $V_G = -2.3\text{ V}$ Typical, CW.

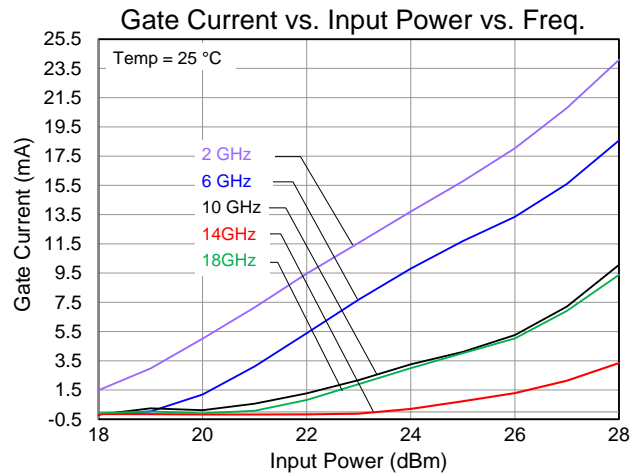
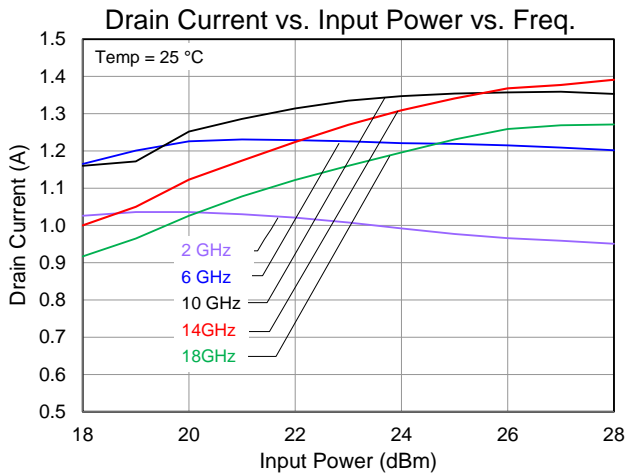
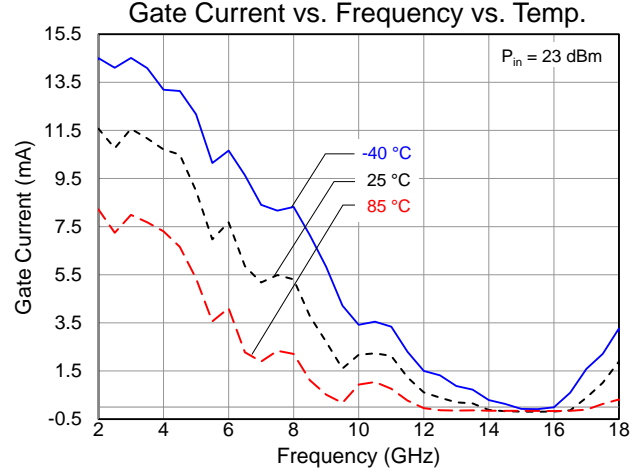
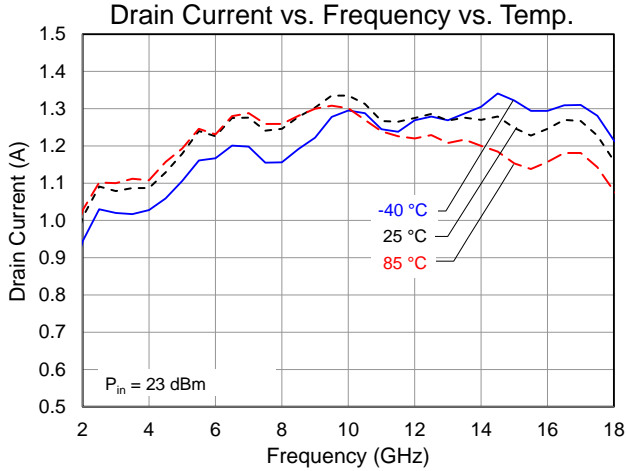

Performance Plots – Linearity

Conditions unless otherwise specified: $V_D = +22V$, $I_{DQ} = 600\text{ mA}$, $V_G = -2.3V$ Typical, CW.

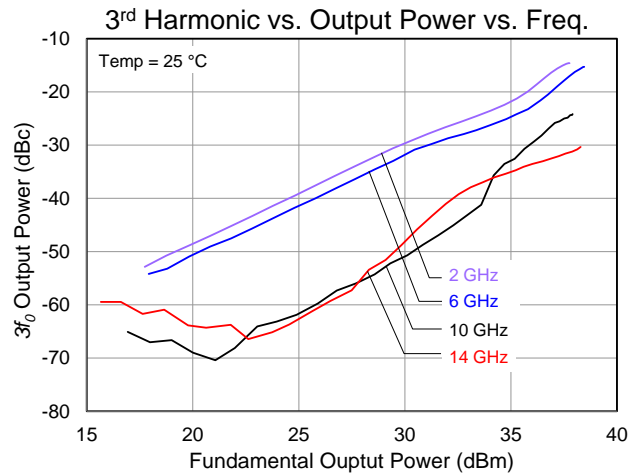
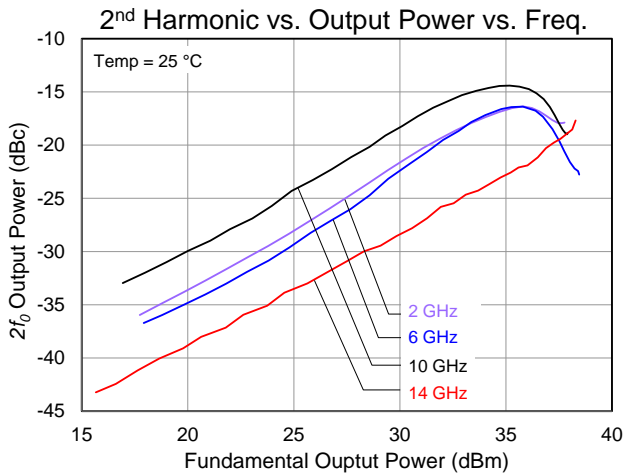
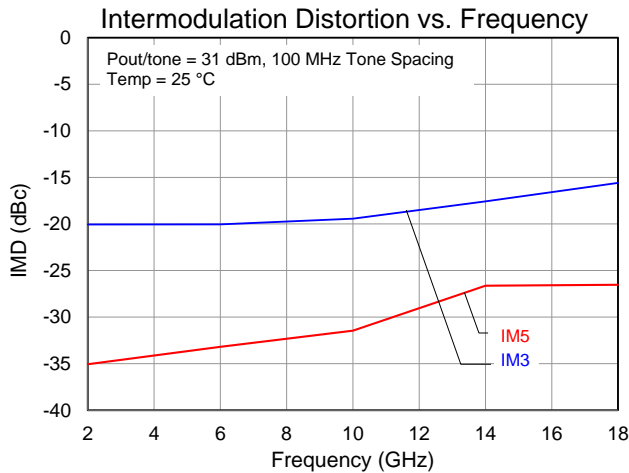
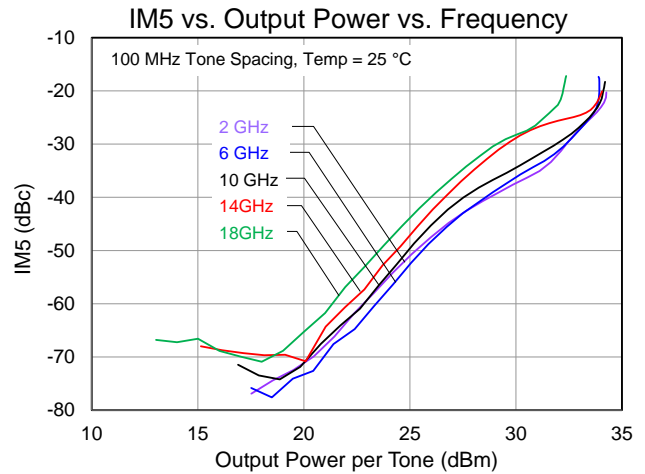
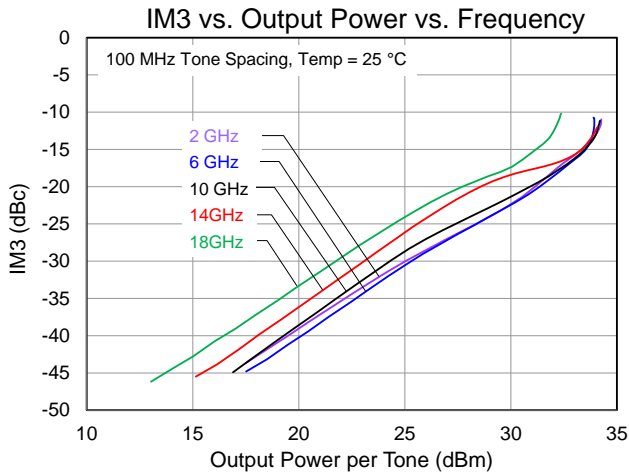

Thermal and Reliability Information

Parameter	Test Conditions	Value	Units
Thermal Resistance (θ_{JC}) ⁽¹⁾	$V_D = +22\text{ V}$, $I_{DQ} = 600\text{ mA}$, $T_{BASE} = 85\text{ }^\circ\text{C}$, CW	3.98	$^\circ\text{C/W}$
Channel Temperature (T_{CH}) (under RF) ⁽²⁾	Freq = 10 GHz, $P_{IN} = 23\text{ dBm}$, $P_{OUT} = 37\text{ dBm}$, $P_{DISS} = 23.6\text{ W}$, $I_{D_Drive} = 1.3\text{ A}$	179	$^\circ\text{C}$

Notes:

1. Thermal resistance is referenced to the back of package ($85\text{ }^\circ\text{C}$)
2. Refer to the following document: [GaN Device Channel Temperature, Thermal Resistance, and Reliability Estimates](#)

Dissipated Power and Maximum Gate Current

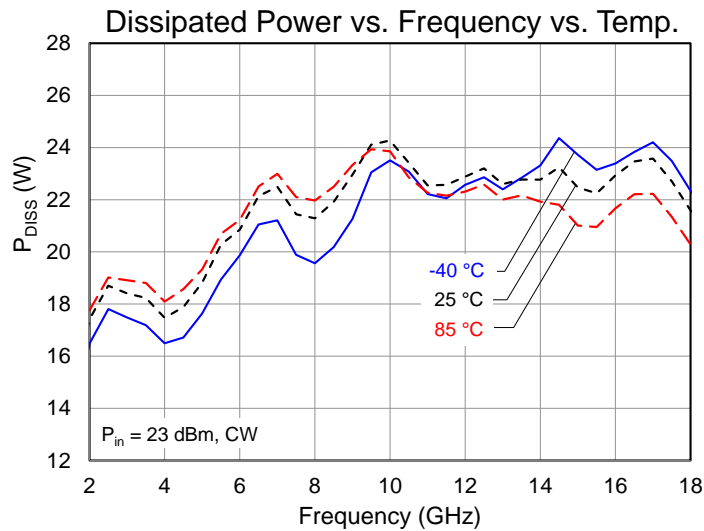
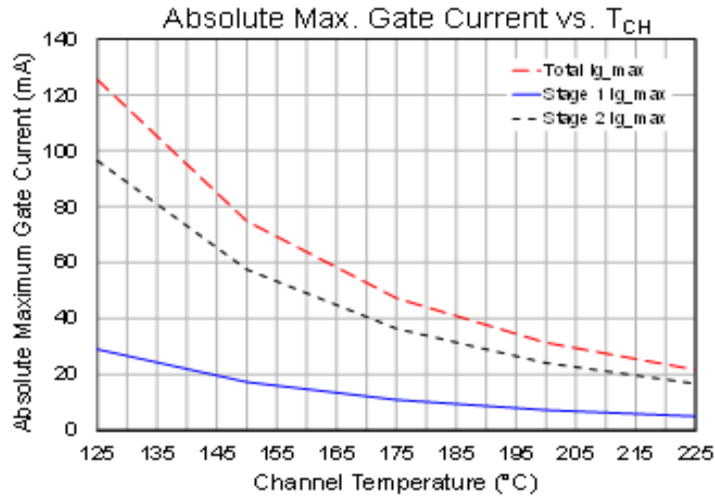

Applications Information and Pin Layout

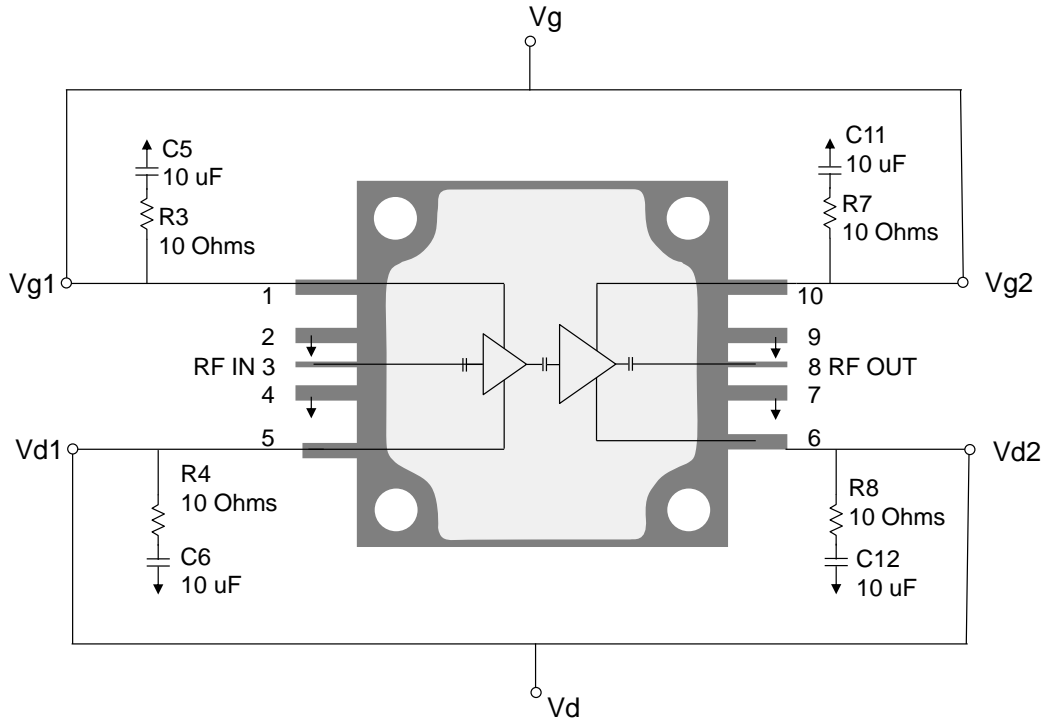

Bias Up Procedure

1. Set I_D limit to 1.5 A, I_G limit to 26 mA
2. Apply -5 V to V_G
3. Apply $+22\text{ V}$ to V_D ; ensure I_{DQ} is approx. 0 mA
4. Adjust V_G until $I_{DQ} = 600\text{ mA}$ ($V_G \sim -2.3\text{ V Typ.}$).
5. Turn on RF supply

Bias Down Procedure

1. Turn off RF supply
2. Reduce V_G to -5 V ; ensure I_{DQ} is approx. 0 mA
3. Set V_D to 0 V
4. Turn off V_D supply
5. Turn off V_G supply

Pad Description

Pin No.	Symbol	Description
1,10	V_{G1}, V_{G2} (respectively)	Gate Voltage; Bias network is required; must be biased from both sides; see recommended Application Information above.
2,4,7,9	GND	Must be grounded on the PCB
3	RF_{IN}	Output; matched to $50\ \Omega$; DC blocked
5,6	V_{D1}, V_{D2} (respectively)	Drain voltage; Bias network is required; must be biased from both sides; see recommended Application Information above.
8	RF_{OUT}	Input; matched to $50\ \Omega$; DC blocked

Evaluation Board

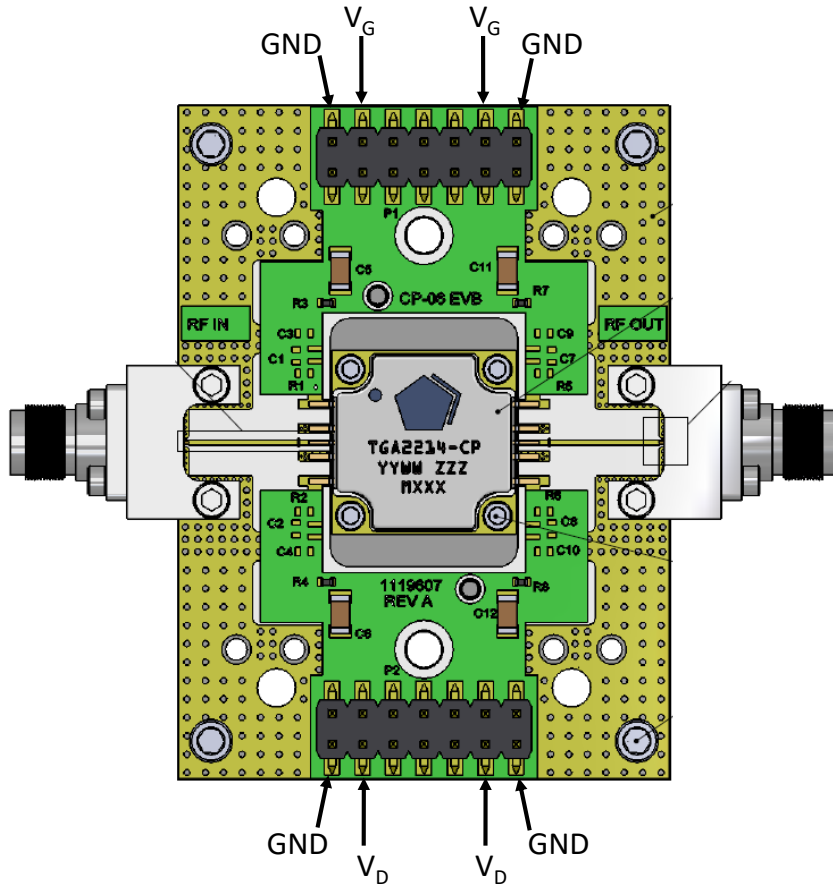

Notes:

1. PCB is made from Rogers 4003C dielectric, 0.008 inch thick, 0.5 oz. copper both sides.
2. Both V_D and V_G pins must be biased.

Bill of Materials

Reference Des.	Value	Description	Manuf.	Part Number
C5, C6, C11, C12	10 μ F	Cap, 1206, +50 V, 20%, X5R	Various	–
R3, R4, R7, R8	10 Ohm	Res, 0402, 5%	Various	–

Assembly Notes

1. Carefully clean the PC board and package leads with alcohol. Allow it to dry fully.
2. To improve the thermal and RF performance, Qorvo recommends attaching a heat sink to the bottom of the PCB and apply thermal compound (Arctic Silver 5 recommended) or 4 mil indium shim between the heat sink and the package.
3. (The following is for *information only*. There are many variables in a second level assembly that Qorvo does not control, so Qorvo does not recommend an absolute torque value.) Use screws to attach the component to the heat sink. A suggested torque value is 16 in-oz. for a 0-80 screw. Start with screws finger tight, then torque to 8 in-oz., then torque to final value. Use the following tightening pattern:

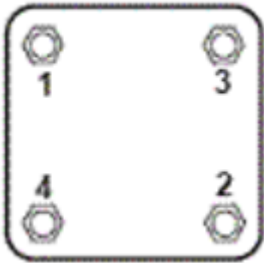

4. Apply no-flux solder to each pin of the TGA2214-CP. The component leads should be manually soldered, and the package cannot be subjected to conventional reflow processes. The use of no-clean solder to avoid washing after soldering is recommended.

Mechanical Information and Marking

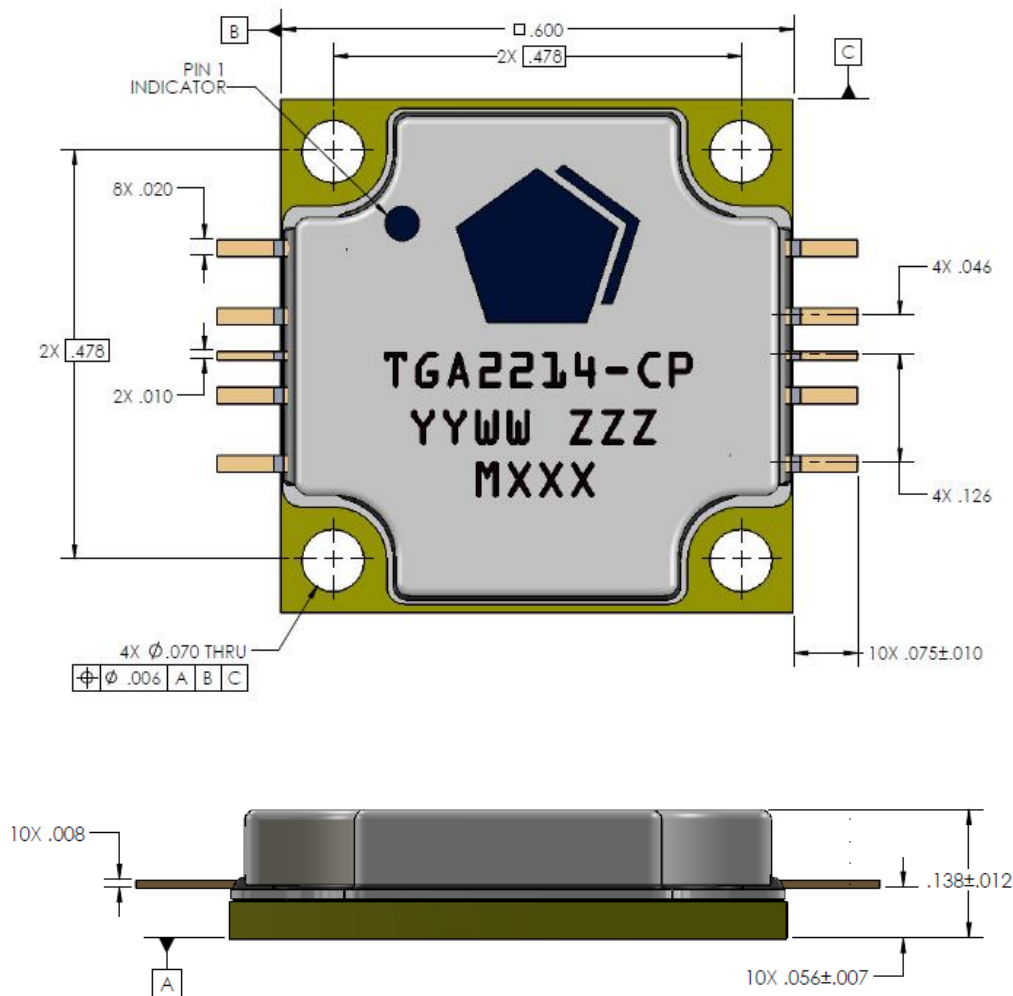

Units: inches

Tolerances: unless specified

x.xx = ± 0.01

x.xxx = ± 0.005

Materials:

Base: Copper

Lid: Plastic

All metalized features are gold plated

Part is epoxy sealed

Marking:

2214: Part number

YY: Part Assembly year

WW: Part Assembly week

ZZZ: Serial Number

MXXX: Batch ID

Handling Precautions

Parameter	Rating	Standard
ESD – Human Body Model (HBM)	Class 0B	ANSI/ESD/JEDEC JS-001
MSL – Moisture Sensitivity Level	N/A	



Caution!
ESD-Sensitive Device

Solderability

Compatible with the latest version of J-STD-020, Lead-free solder, 260 °C

RoHS Compliance

This product is compliant with the 2011/65/EU RoHS directive (Restrictions on the Use of Certain Hazardous Substances in Electrical and Electronic Equipment), as amended by Directive 2015/863/EU. This product also has the following attributes:

- Product uses RoHS Exemption 7c-I to meet RoHS compliance requirements
- Halogen Free (Chlorine, Bromine)
- Antimony Free
- TBBP-A (C₁₅H₁₂Br₄O₂) Free
- PFOS Free
- SVHC Free

Contact Information

For the latest specifications, additional product information, worldwide sales and distribution locations:

Web: www.qorvo.com

Tel: 1-844-890-8163

Email: customer.support@qorvo.com

Important Notice

The information contained herein is believed to be reliable; however, Qorvo makes no warranties regarding the information contained herein and assumes no responsibility or liability whatsoever for the use of the information contained herein. All information contained herein is subject to change without notice. Customers should obtain and verify the latest relevant information before placing orders for Qorvo products. The information contained herein or any use of such information does not grant, explicitly or implicitly, to any party any patent rights, licenses, or any other intellectual property rights, whether with regard to such information itself or anything described by such information. **THIS INFORMATION DOES NOT CONSTITUTE A WARRANTY WITH RESPECT TO THE PRODUCTS DESCRIBED HEREIN, AND QORVO HEREBY DISCLAIMS ANY AND ALL WARRANTIES WITH RESPECT TO SUCH PRODUCTS WHETHER EXPRESS OR IMPLIED BY LAW, COURSE OF DEALING, COURSE OF PERFORMANCE, USAGE OF TRADE OR OTHERWISE, INCLUDING THE IMPLIED WARRANTIES OF MERCHANTABILITY AND FITNESS FOR A PARTICULAR PURPOSE.**

Without limiting the generality of the foregoing, Qorvo products are not warranted or authorized for use as critical components in medical, life-saving, or life-sustaining applications, or other applications where a failure would reasonably be expected to cause severe personal injury or death.

Copyright 2019 © Qorvo, Inc. | Qorvo is a registered trademark of Qorvo, Inc.

X-ON Electronics

Largest Supplier of Electrical and Electronic Components

Click to view similar products for [RF Development Tools](#) category:

Click to view products by [Qorvo](#) manufacturer:

Other Similar products are found below :

[MAAM-011117](#) [MAAP-015036-DIEEV2](#) [EV1HMC1113LP5](#) [EV1HMC6146BLC5A](#) [EV1HMC637ALP5](#) [EVAL-ADG919EBZ](#) [ADL5363-EVALZ](#) [LMV228SDEVAL](#) [SKYA21001-EVB](#) [SMP1331-085-EVB](#) [EV1HMC618ALP3](#) [EVAL01-HMC1041LC4](#) [MAAL-011111-000SMB](#)
[MAAM-009633-001SMB](#) [MASW-000936-001SMB](#) [107712-HMC369LP3](#) [107780-HMC322ALP4](#) [SP000416870](#) [EV1HMC470ALP3](#)
[EV1HMC520ALC4](#) [EV1HMC244AG16](#) [MAX2614EVKIT#](#) [124694-HMC742ALP5](#) [SC20ASATEA-8GB-STD](#) [MAX2837EVKIT+](#)
[MAX2612EVKIT#](#) [MAX2692EVKIT#](#) [EV1HMC629ALP4E](#) [SKY12343-364LF-EVB](#) [108703-HMC452QS16G](#) [EV1HMC863ALC4](#)
[EV1HMC427ALP3E](#) [119197-HMC658LP2](#) [EV1HMC647ALP6](#) [ADL5725-EVALZ](#) [106815-HMC441LM1](#) [EV1HMC1018ALP4](#)
[UXN14M9PE](#) [MAX2016EVKIT](#) [EV1HMC939ALP4](#) [MAX2410EVKIT](#) [MAX2204EVKIT+](#) [EV1HMC8073LP3D](#) [SIMSA868-DKL](#)
[SIMSA868C-DKL](#) [SKY65806-636EK1](#) [SKY68020-11EK1](#) [SKY67159-396EK1](#) [SKY66181-11-EK1](#) [SKY65804-696EK1](#)