

Product Description

Qorvo's TGA2239-CP is a 3-stage, 50 W power amplifier operating over the 13.4 to 15.5 GHz band. Fabricated on Qorvo's production 0.15 um GaN on SiC technology, this high performance amplifier offers greater than 30 dB small-signal gain and greater than 31 % power-added efficiency, allowing the system designer to achieve superior performance levels in a cost efficient manner.

The TGA2239-CP is offered in a 10-lead 15 x 15 mm bolt-down package. Assembled with a pure-copper base, coupled with its high efficiency, the TGA2239-CP minimizes the strain on the system-level cooling requirements, further reducing system operating costs. Superior electrical performance and thermal management makes the TGA2239-CP ideal for supporting communications and radar applications in both commercial and military markets.

Both RF ports have integrated DC blocking capacitors and are fully matched to 50 Ohms.

RoHS compliant.



Product Features

- Frequency Range: 13.4 – 15.5 GHz
- P_{OUT} : >45.5 dBm (P_{IN} = 22 dBm)
- PAE: > 31 % (P_{IN} = 22 dBm)
- Small Signal Gain: > 30 dB
- IM3: < -19 dBc @ 38 dBm P_{OUT} /Tone
- Bias: V_D = +28 V, I_{DQ} = 900 mA, V_G = -2.7 V Typical
- Package Dimensions: 15.2 x 15.2 x 3.5 mm
- Process Technology: QGaN15
- Package base is pure Cu offering superior thermal management

Functional Block Diagram

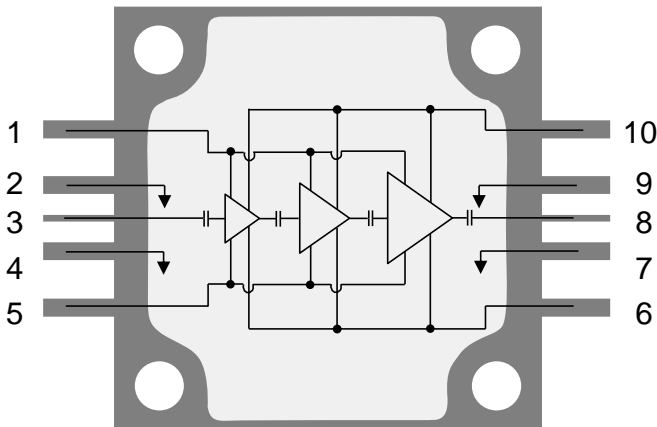

Applications

- Commercial VSAT
- Military Satcom
- Datalinks
- Radar

Ordering Information

Part No.	Description
TGA2239-CP	13.4 – 15.5 GHz 50 W GaN Power Amplifier (10 pieces)
TGA2239-CPEVB01	TGA2239-CP Evaluation Board

Absolute Maximum Ratings

Parameter	Value / Range
Drain Voltage (V_D)	+29.5 V
Gate Voltage Range (V_G)	-5 to 0 V
Drain Current (I_D)	7.2 A
Forward Gate Current (I_G)	See plot on page 3
Power Dissipation (P_{DISS}), 85 °C	140 W
Input Power (P_{IN}), CW, 50 Ω , $V_D = +28$ V, 85 °C	33 dBm
Input Power (P_{IN}), CW, 3:1 VSWR, $V_D = +28$ V, 85 °C	30 dBm
Mounting Temperature (30 Seconds)	260 °C
Storage Temperature	-55 to 150 °C

Operation of this device outside the parameter ranges given above may cause permanent damage. These are stress ratings only, and functional operation of the device at these conditions is not implied.

Recommended Operating

Parameter	Value / Range
Drain Voltage (V_D)	+28 V
Drain Current (I_{DQ})	900 mA
Drain Current Under RF Drive (I_{D_DRIVE})	See plots p. 7
Gate Current Under RF Drive (I_{G_DRIVE})	See plots p. 7
Temperature (T_{BASE})	-40 to 85 °C

Electrical specifications are measured at specified test conditions. Specifications are not guaranteed over all recommended operating conditions.

Electrical Specifications

Parameter		Min	Typ	Max	Units
Operational Frequency Range		13.4	–	15.5	GHz
Small Signal Gain		–	> 30	–	dB
Input Return Loss		–	> 14	–	dB
Output Return Loss		–	> 9	–	dB
Output Power ($P_{IN} = 22$ dBm)	13.0 GHz	46	46.5	–	dBm
	14.5 GHz	46	47		
	15.5 GHz	45	47		
Power Added Efficiency ($P_{IN} = 22$ dBm)	13.0 GHz	25	30	–	%
	14.5 GHz	25	32		
	15.5 GHz	30	33		
IM3 ($P_{OUT}/Tone = 38$ dBm/Tone, 1 MHz Spacing)		–	< -19	–	dBc
IM5 ($P_{OUT}/Tone = 38$ dBm/Tone, 1 MHz Spacing)		–	< -30	–	dBc
Small Signal Gain Temperature Coefficient		–	-0.09	–	dB/°C
Output Power Temperature Coefficient ($P_{IN} = 22$ dBm) (From 25 °C to 85 °C)		–	-0.014	–	dBm/°C
Recommended Operating Voltage		–	+28	+28	V

Test conditions unless otherwise noted: 25 °C, $V_D = +28$ V, $I_{DQ} = 900$ mA, CW operation

Thermal and Reliability Information

Parameter	Test Conditions	Value	Units
Thermal Resistance (θ_{JC}) ⁽¹⁾	$T_{BASE} = 85^{\circ}\text{C}$, $V_D = +28\text{ V}$ (CW)	0.52	$^{\circ}\text{C}/\text{W}$
Channel Temperature (T_{CH}) (Quiescent)	At $I_{DQ} = 900\text{ mA}$, $P_{DISS} = 25.2\text{ W}$	98	$^{\circ}\text{C}$
Thermal Resistance (θ_{JC}) ⁽¹⁾	$T_{BASE} = 85^{\circ}\text{C}$, $V_D = +22\text{ V}$ (CW)	0.79	$^{\circ}\text{C}/\text{W}$
Channel Temperature (T_{CH}) (Under RF drive)	At Freq = 15 GHz, $P_{IN} = 24\text{ dBm}$: $I_{DQ} = 900\text{ mA}$, $I_{D_Drive} = 5.1\text{ A}$ $P_{OUT} = 45.4\text{ dBm}$, $P_{DISS} = 77\text{ W}$	146	$^{\circ}\text{C}$
Thermal Resistance (θ_{JC}) ⁽¹⁾	$T_{BASE} = 85^{\circ}\text{C}$, $V_D = +28\text{ V}$ (CW)	0.79	$^{\circ}\text{C}/\text{W}$
Channel Temperature (T_{CH}) (Under RF drive)	At Freq = 15 GHz, $P_{IN} = 27\text{ dBm}$: $I_{DQ} = 900\text{ mA}$, $I_{D_Drive} = 5.8\text{ A}$ $P_{OUT} = 46.7\text{ dBm}$, $P_{DISS} = 116\text{ W}$	177	$^{\circ}\text{C}$

Notes:

1. Thermal resistance measured to back of package.
2. Refer to the following document: [GaN Device Channel Temperature, Thermal Resistance, and Reliability Estimates](#)

Dissipated Power

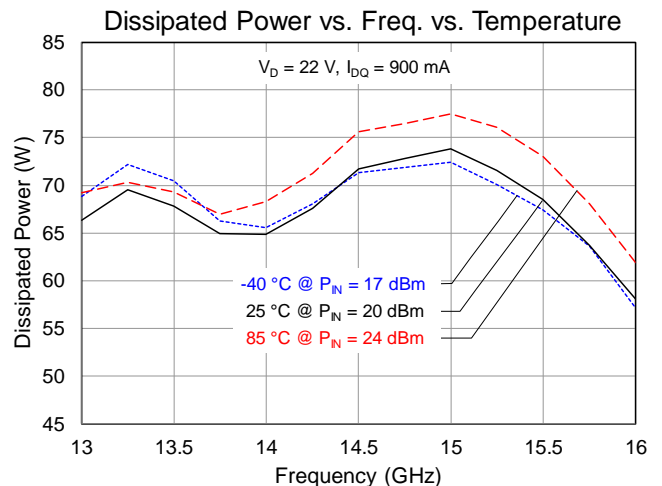
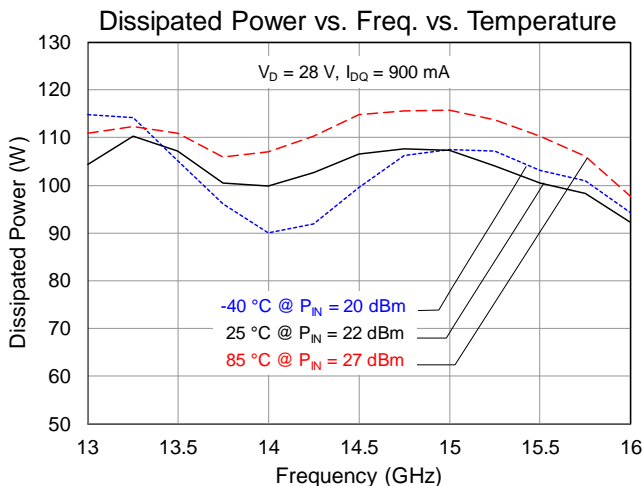
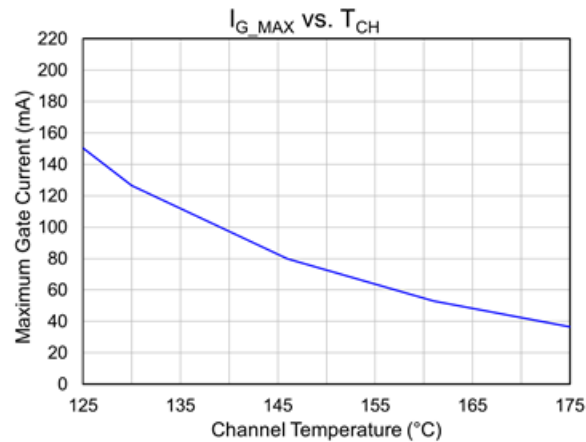

Performance Plots – Small Signal

Conditions unless otherwise specified: $V_D = +28\text{ V}$, $I_{DQ} = 900\text{ mA}$, Temp. = $25\text{ }^\circ\text{C}$, CW operation

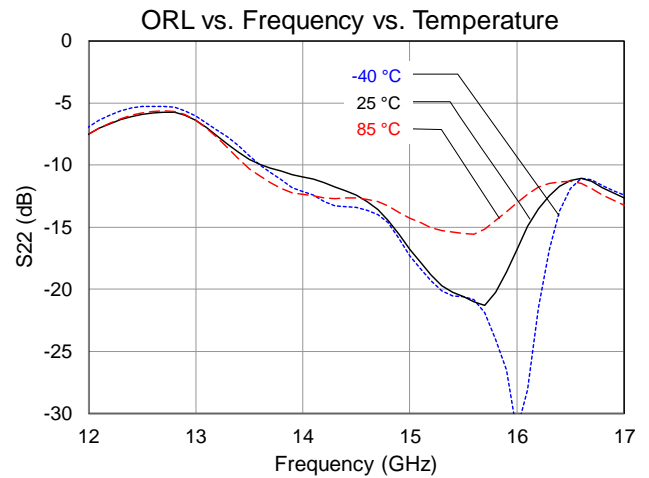
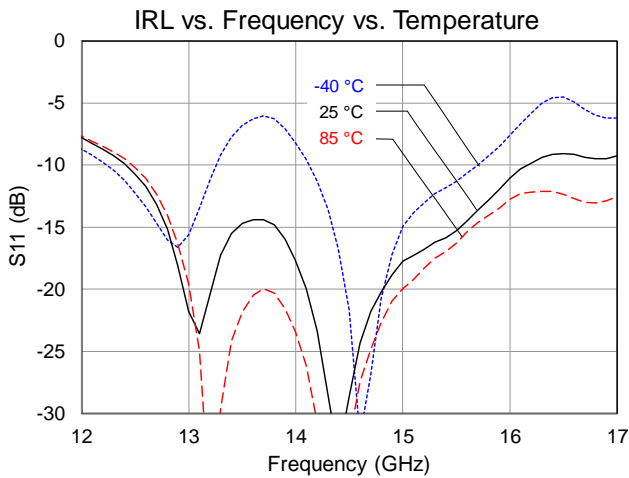
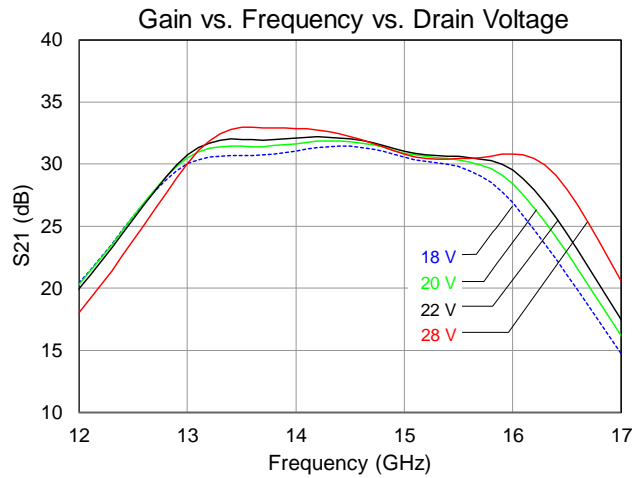
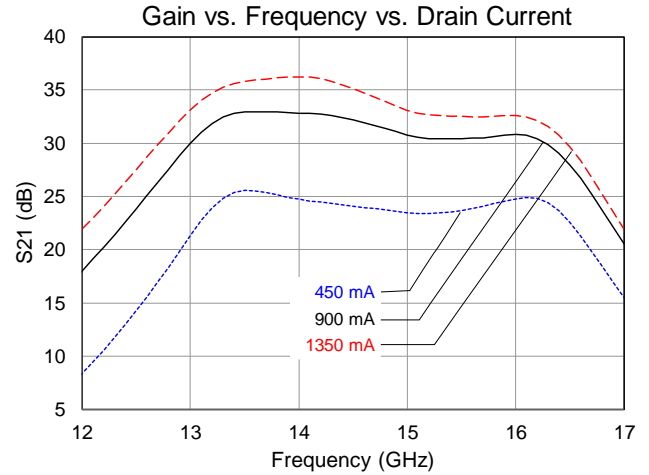
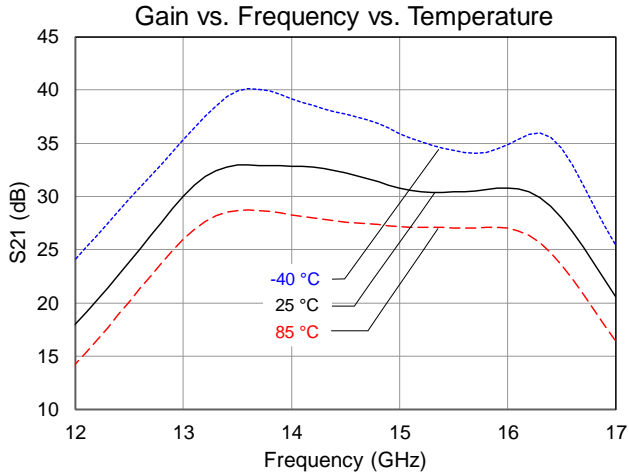

Performance Plots – Large Signal

Conditions unless otherwise specified: $V_D = +28\text{ V}$, $I_{DQ} = 900\text{ mA}$, Temp. = $25\text{ }^\circ\text{C}$, CW operation

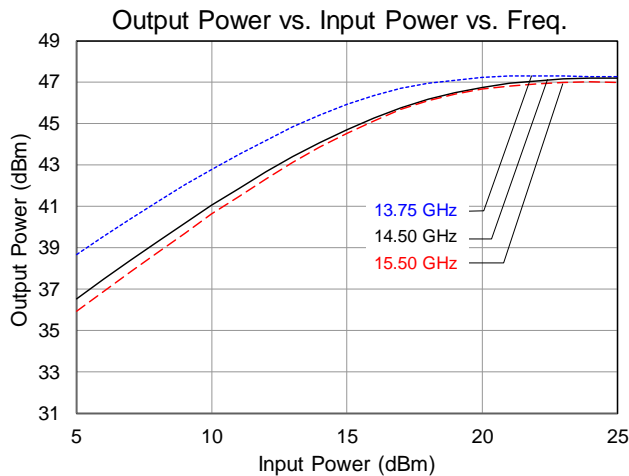
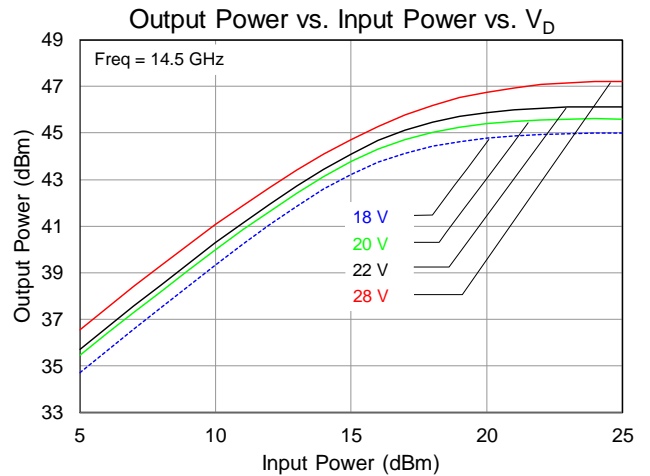
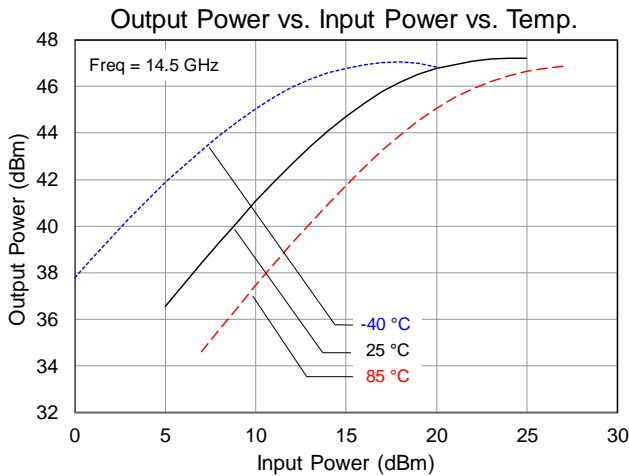
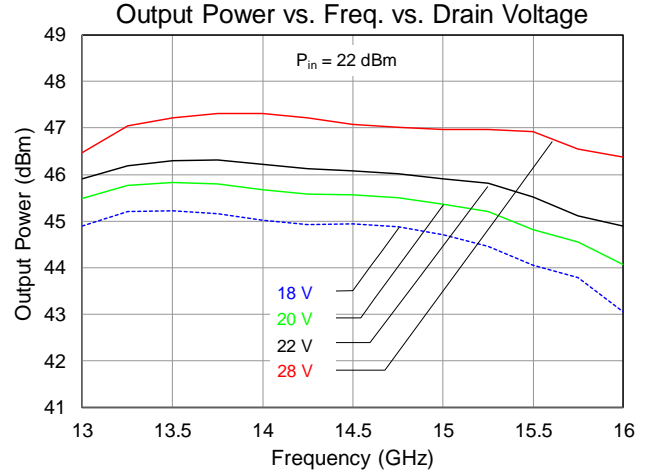
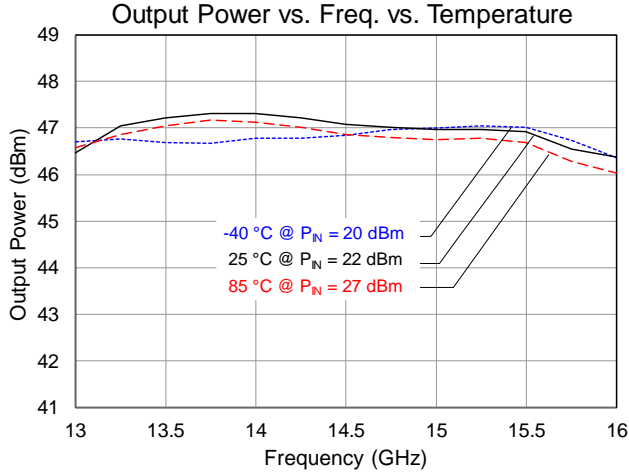

Performance Plots – Large Signal

Conditions unless otherwise specified: $V_D = +28\text{ V}$, $I_{DQ} = 900\text{ mA}$, Temp. = 25 °C, CW operation

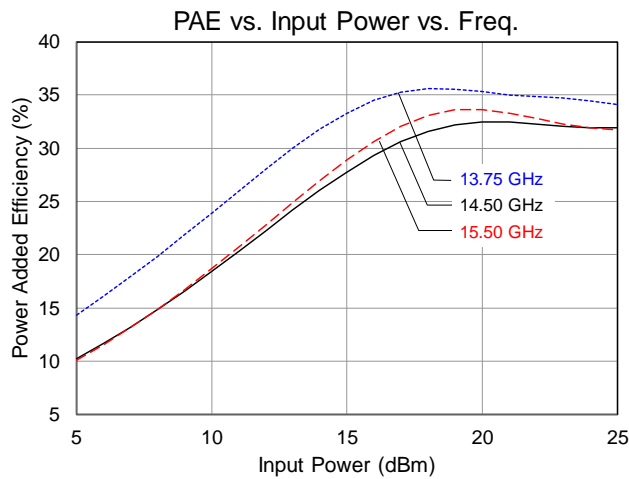
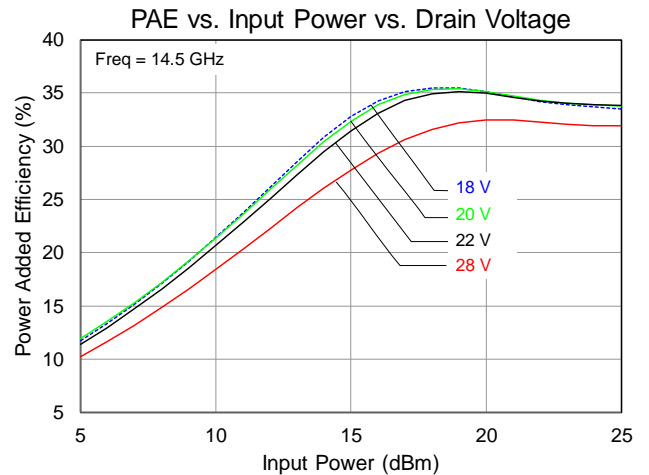
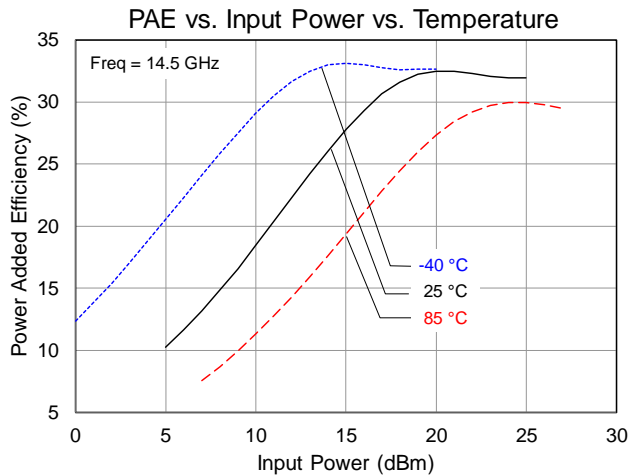
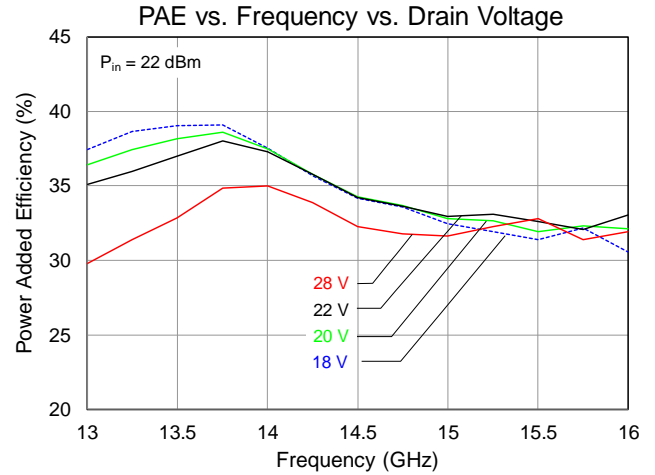
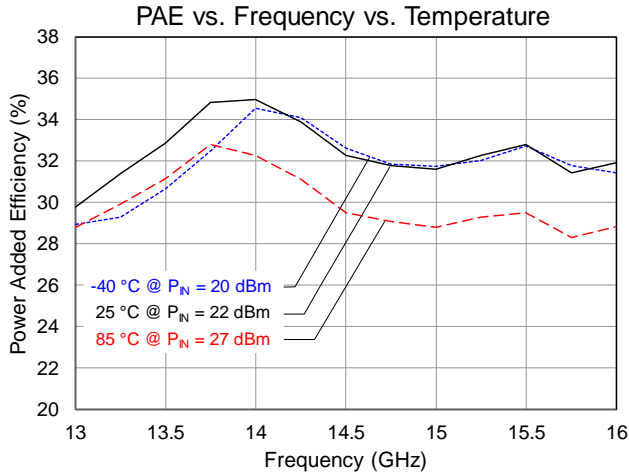

Performance Plots – Large Signal

Conditions unless otherwise specified: $V_D = +28\text{ V}$, $I_{DQ} = 900\text{ mA}$, Temp. = $25\text{ }^\circ\text{C}$, CW operation

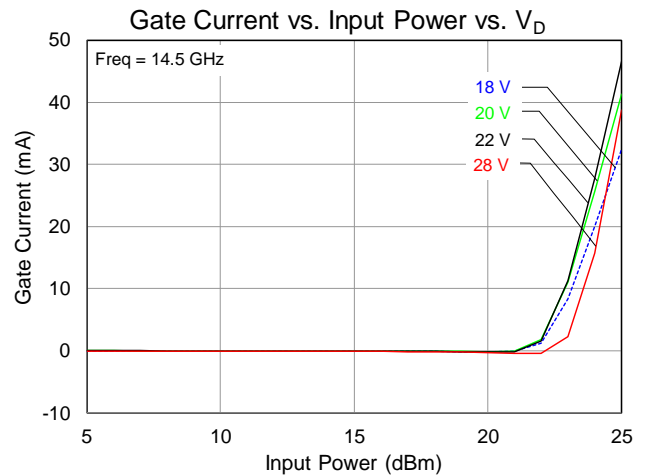
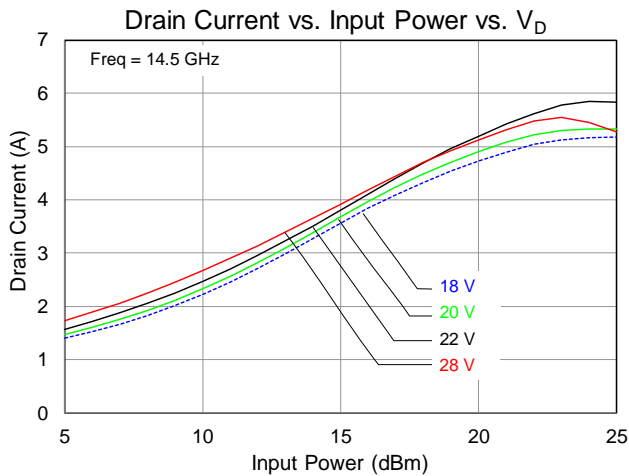
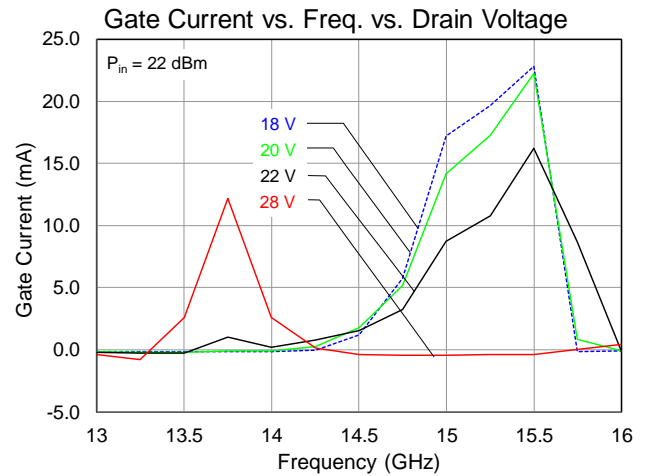
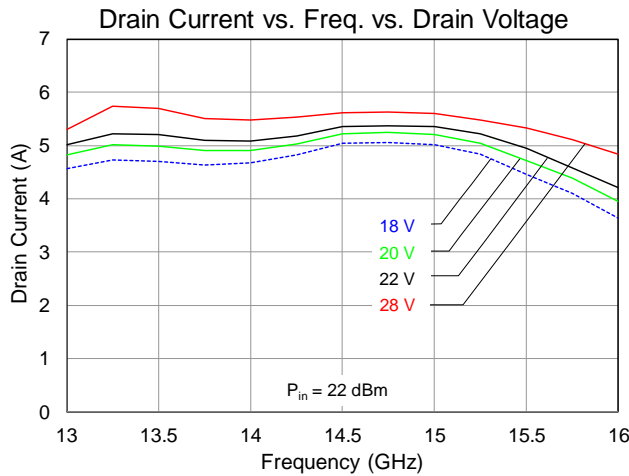
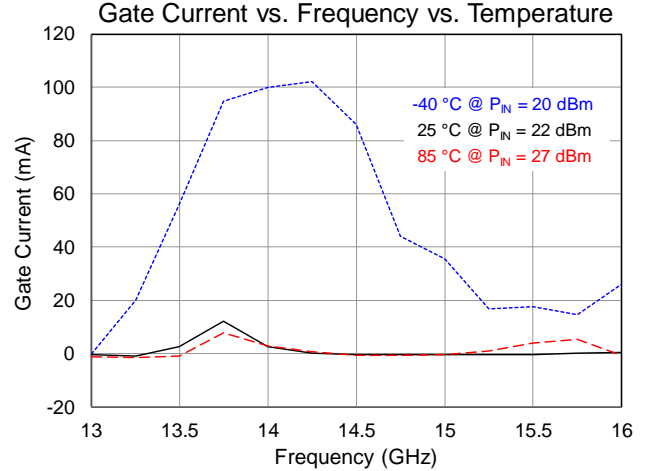
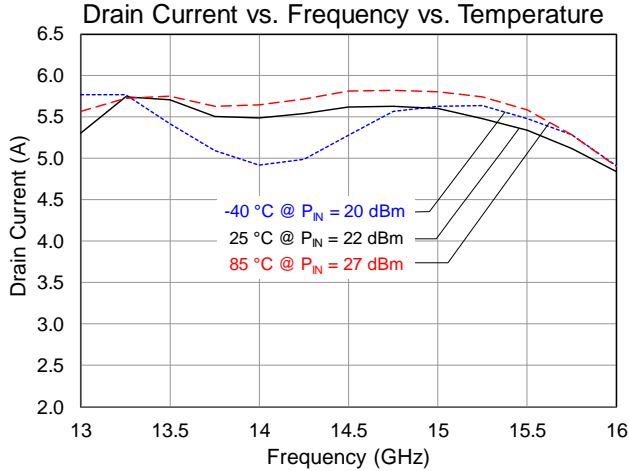

Performance Plots – Large Signal

Conditions unless otherwise specified: $V_D = +28\text{ V}$, $I_{DQ} = 900\text{ mA}$, Temp. = $25\text{ }^\circ\text{C}$, CW operation

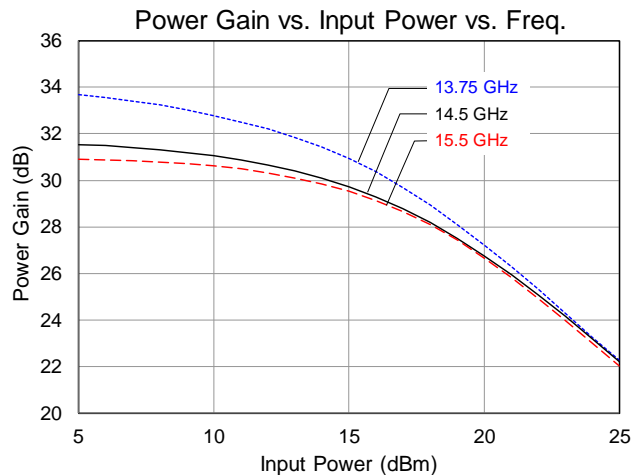
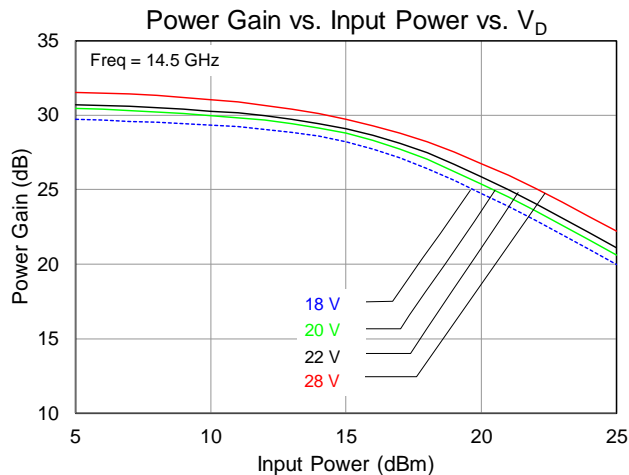
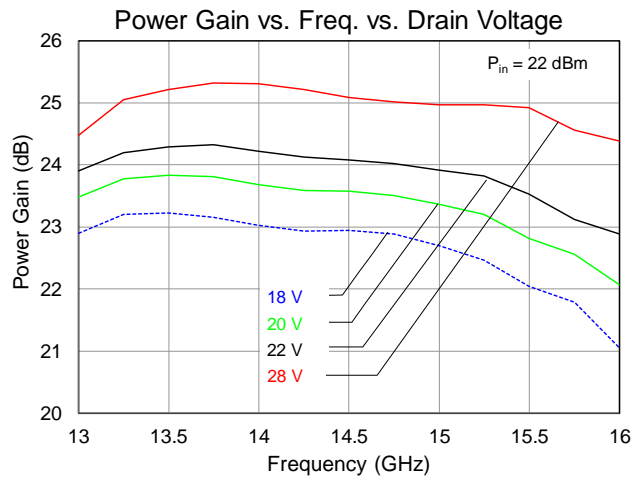
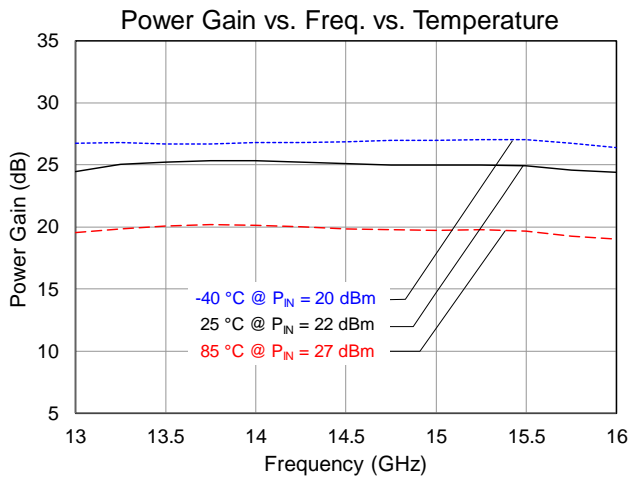
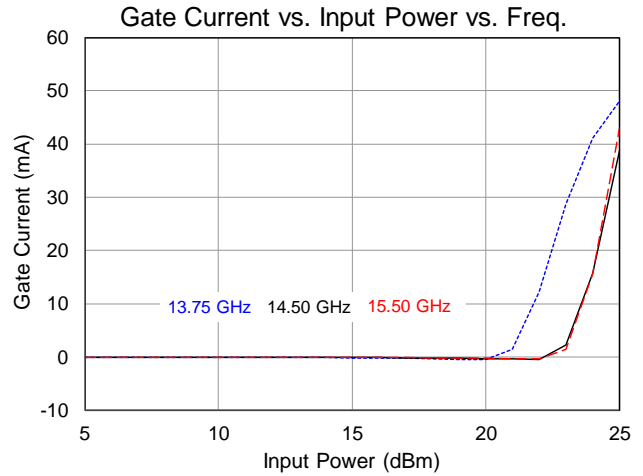
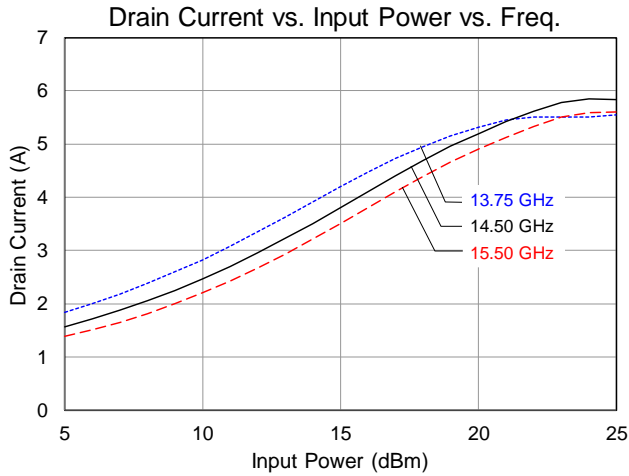

Performance Plots – Linearity

Conditions unless otherwise specified: $V_D = +28\text{ V}$, $I_{DQ} = 900\text{ mA}$, $\text{Temp.} = 25\text{ }^\circ\text{C}$, CW operation, Input Tone Spacing = 1 MHz

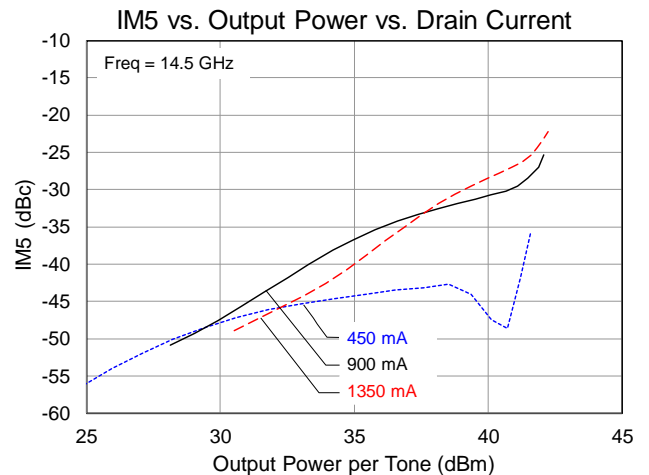
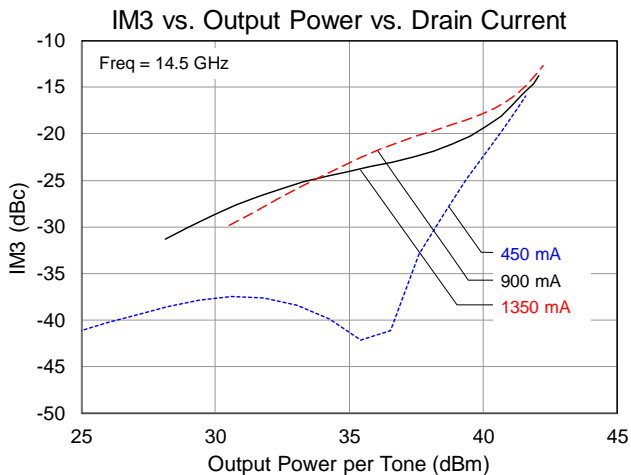
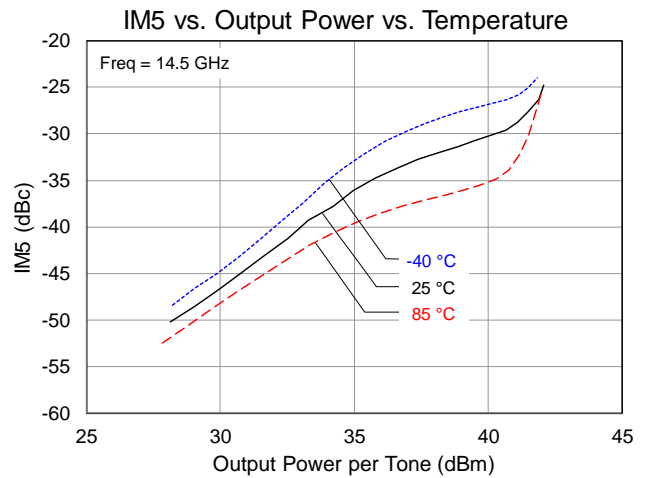
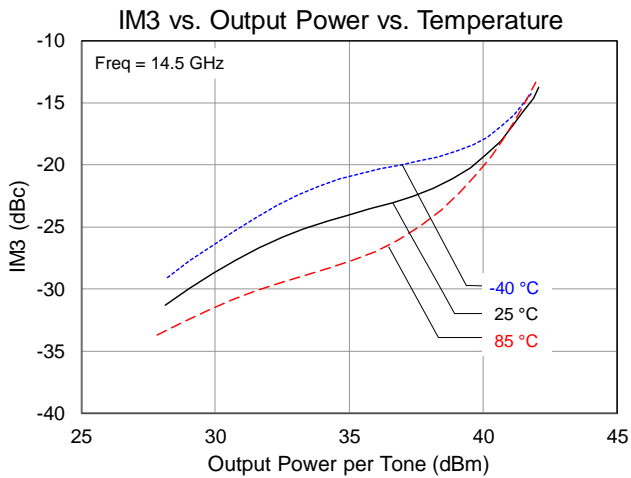
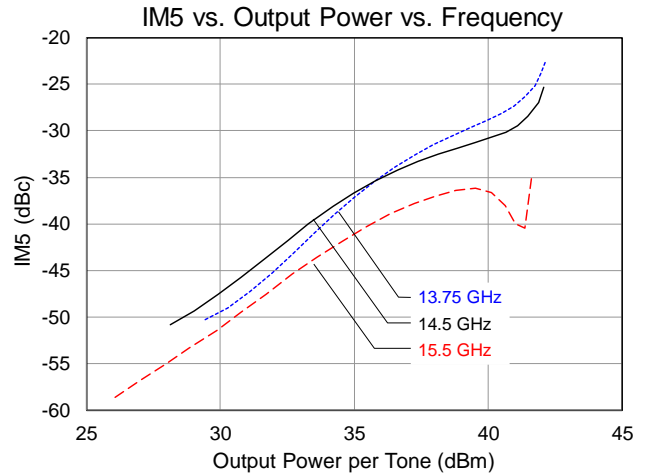
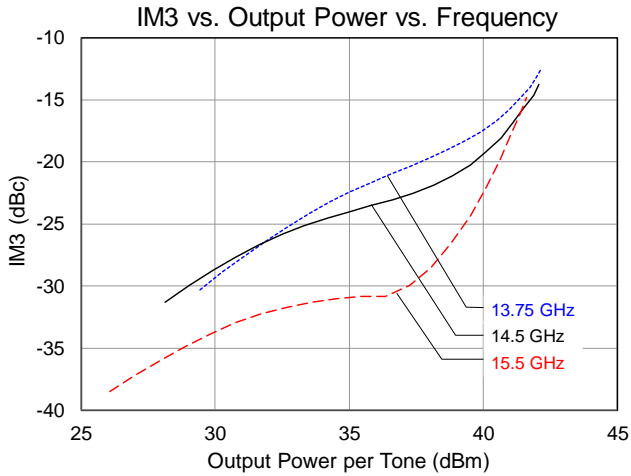

Performance Plots – Linearity

Conditions unless otherwise specified: $V_D = +28\text{ V}$, $I_{DQ} = 900\text{ mA}$, $\text{Temp.} = 25\text{ }^\circ\text{C}$, CW operation, Input Tone Spacing = 1 MHz

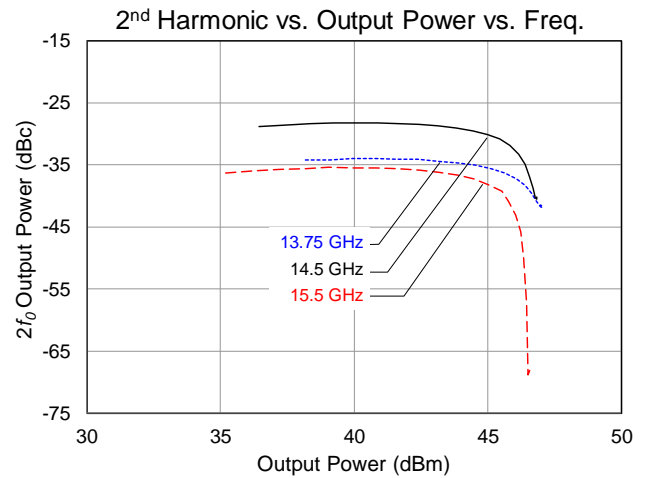
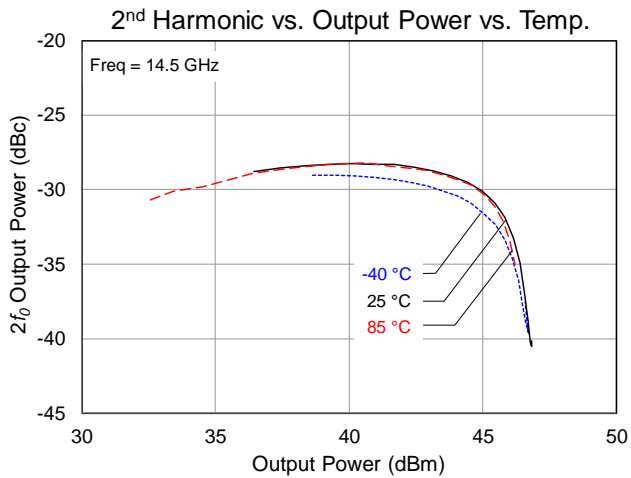
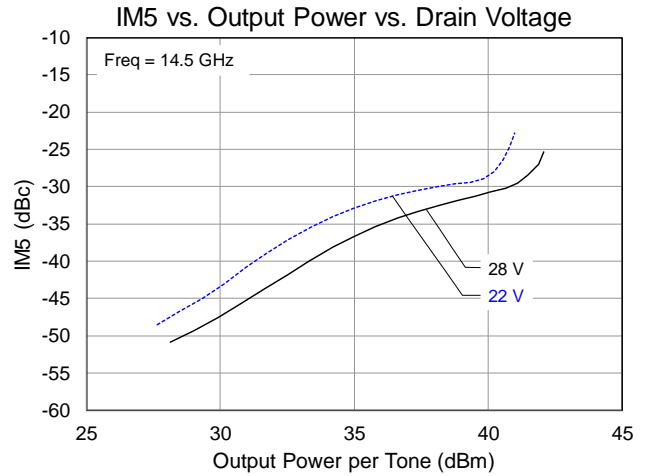
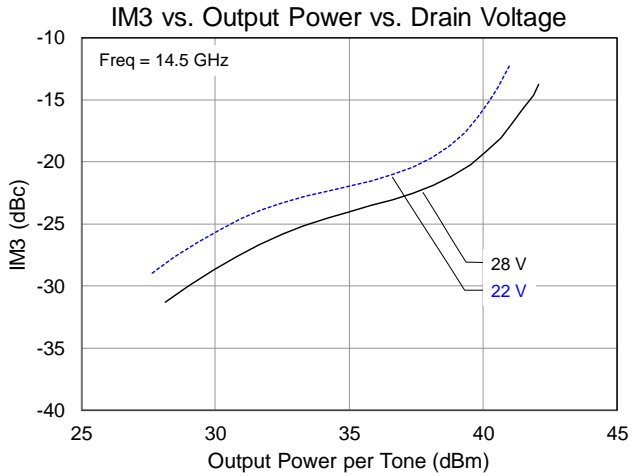

Applications Information and Pad Layout

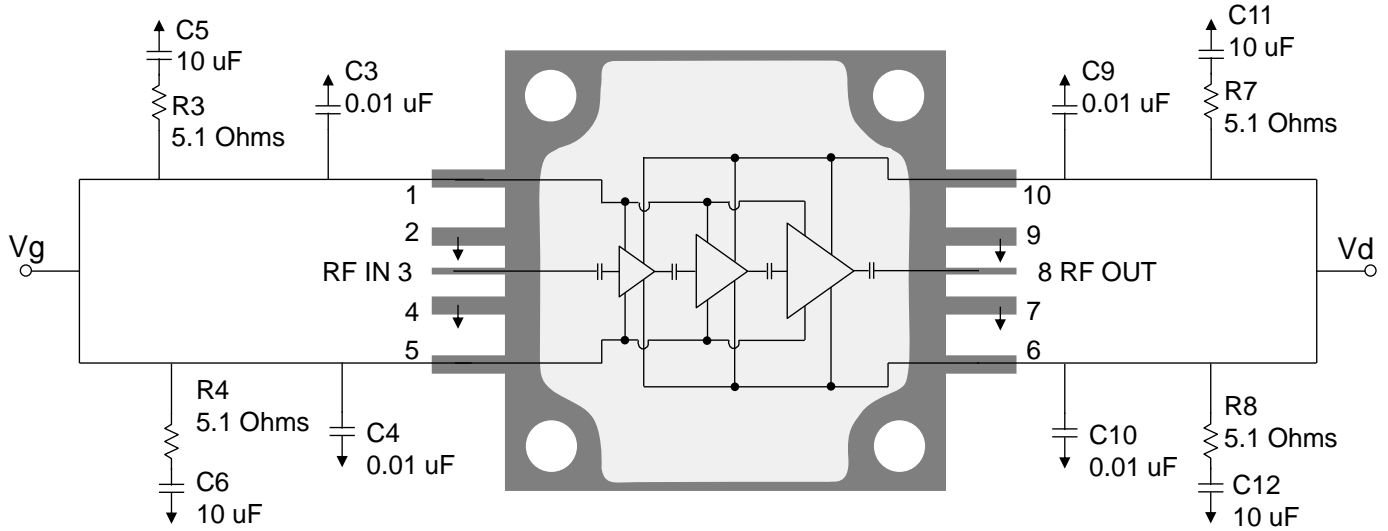

Bias Up Procedure

1. Set I_D limit to 6.3 A, I_G limit to 110 mA
2. Apply -5 V to V_G
3. Apply $+28\text{ V}$ to V_D ; ensure I_{DQ} is approx. 0 mA
4. Adjust V_G until $I_{DQ} = 900\text{ mA}$ ($V_G \sim -2.7\text{ V Typ.}$).
5. Turn on RF supply

Bias Down Procedure

1. Turn off RF supply
2. Reduce V_G to -5 V ; ensure I_{DQ} is approx. 0 mA
3. Set V_D to 0 V
4. Turn off V_D supply
5. Turn off V_G supply

Pin Description

Pad No.	Symbol	Description
1,5	V_G	Gate Voltage; Bias network is required; must be biased from both sides; see recommended Application Information above.
3	RF_{IN}	Input; matched to $50\ \Omega$; DC blocked
2,4,7,9	GND	Must be grounded on the PCB.
6,10	V_D	Drain voltage; Bias network is required; must be biased from both sides; see recommended Application Information above.
8	RF_{OUT}	Output; matched to $50\ \Omega$; DC blocked

Evaluation Board

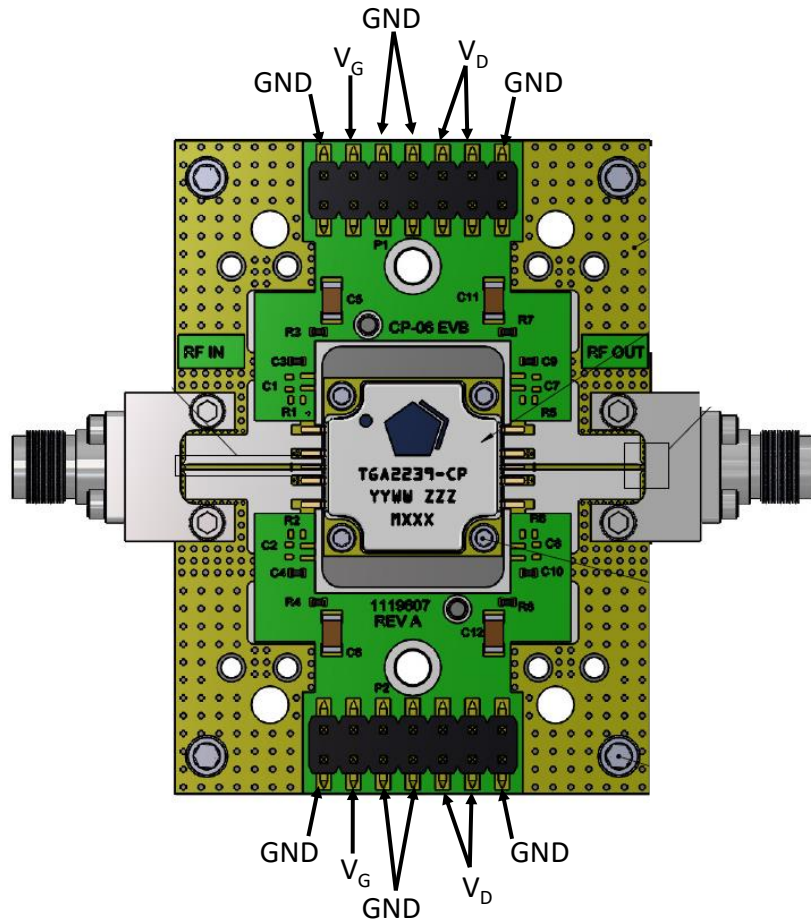

- Notes:
- Both Top and Bottom Vd and Vg must be biased.

Bill of Materials

Reference Des.	Value	Description	Manuf.	Part Number
C3, C4, C9, C10	0.01 μ F	Cap, 0402, 50 V, 10 %, X7R	Various	–
C5, C6, C11, C12	10 μ F	Cap, 1206, 50 V, 20 %, X5R	Various	–
R3, R4, R7, R8	5.1 Ohm	Res, 0402, 50 V, 5 %	Various	–

Assembly Notes

1. Carefully clean the PC board and package leads with alcohol. Allow it to dry fully.
2. To improve the thermal and RF performance, Qorvo recommends attaching a heat sink to the bottom of the PCB and apply thermal compound (Arctic Silver 5 recommended) or 4 mil indium shim between the heat sink and the package.
3. (The following is for *information only*. There are many variables in a second level assembly that Qorvo does not control, so Qorvo does not recommend an absolute torque value.) Use screws to attach the component to the heat sink. A suggested torque value is 16 in-oz. for a 0-80 screw. Start with screws finger tight, then torque to 8 in-oz., then torque to final value. Use the following tightening pattern:

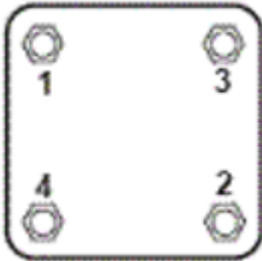

4. Apply no-flux solder to each pin of the TGA2239-CP. The component leads should be manually soldered, and the package cannot be subjected to conventional reflow processes. The use of no-clean solder to avoid washing after soldering is recommended.

Mechanical Information

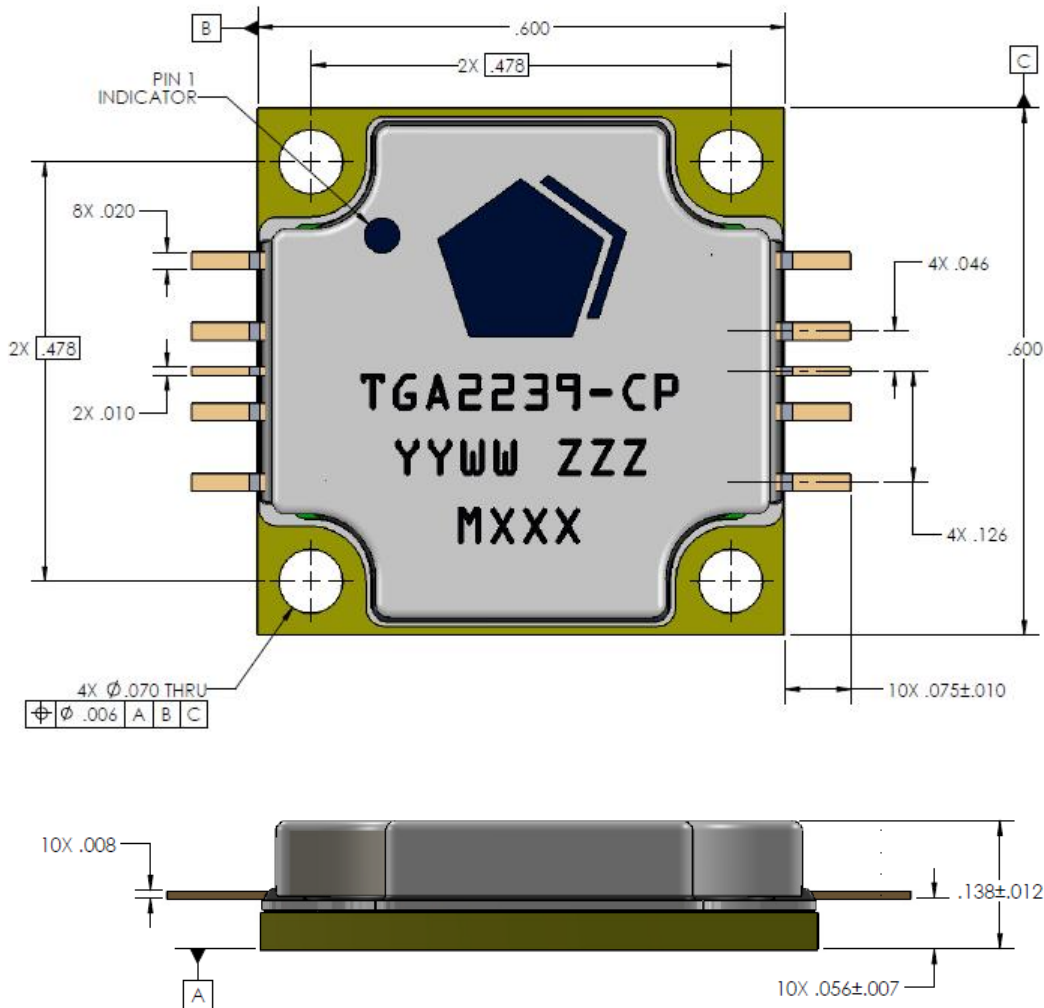

Units: inches

Tolerances: unless specified

x.xx = ± 0.01

x.xxx = ± 0.005

Materials:

Base: Copper

Lid: Plastic

All metalized features are gold plated

Part is epoxy sealed

Marking:

2239: Part number

YY: Part Assembly year

WW: Part Assembly week

ZZZ: Serial Number

MXXX: Batch ID

Handling Precautions

Parameter	Rating	Standard
ESD – Human Body Model (HBM)	Class 1B	JEDEC Standard JESD22 A114
MSL – Moisture Sensitivity Level	N/A	



Caution!
ESD-Sensitive Device

Solderability

The component leads should be manually soldered, and the package cannot be subjected to conventional reflow processes. Soldering of the component leads is compatible with the latest version of J-STD-020, lead-free solder, 260 °C. The use of no-clean solder to avoid washing after soldering is recommended.

RoHS Compliance

This product is compliant with the 2011/65/EU RoHS directive (Restrictions on the Use of Certain Hazardous Substances in Electrical and Electronic Equipment), as amended by Directive 2015/863/EU. This product also has the following attributes:

- Product uses RoHS Exemption 7c-1 to meet RoHS Compliance requirements
- Halogen Free (Chlorine, Bromine)
- Antimony Free
- TBBP-A (C₁₅H₁₂Br₄O₂) Free
- PFOS Free
- SVHC Free

Contact Information

For the latest specifications, additional product information, worldwide sales and distribution locations:

Web: www.qorvo.com
Tel: 1-844-890-8163
Email: customer.support@qorvo.com

Important Notice

The information contained herein is believed to be reliable; however, Qorvo makes no warranties regarding the information contained herein and assumes no responsibility or liability whatsoever for the use of the information contained herein. All information contained herein is subject to change without notice. Customers should obtain and verify the latest relevant information before placing orders for Qorvo products. The information contained herein or any use of such information does not grant, explicitly or implicitly, to any party any patent rights, licenses, or any other intellectual property rights, whether with regard to such information itself or anything described by such information. **THIS INFORMATION DOES NOT CONSTITUTE A WARRANTY WITH RESPECT TO THE PRODUCTS DESCRIBED HEREIN, AND QORVO HEREBY DISCLAIMS ANY AND ALL WARRANTIES WITH RESPECT TO SUCH PRODUCTS WHETHER EXPRESS OR IMPLIED BY LAW, COURSE OF DEALING, COURSE OF PERFORMANCE, USAGE OF TRADE OR OTHERWISE, INCLUDING THE IMPLIED WARRANTIES OF MERCHANTABILITY AND FITNESS FOR A PARTICULAR PURPOSE.**

Without limiting the generality of the foregoing, Qorvo products are not warranted or authorized for use as critical components in medical, life-saving, or life-sustaining applications, or other applications where a failure would reasonably be expected to cause severe personal injury or death.

Copyright 2021 © Qorvo, Inc. | Qorvo is a registered trademark of Qorvo, Inc.

X-ON Electronics

Largest Supplier of Electrical and Electronic Components

Click to view similar products for [RF Amplifier](#) category:

Click to view products by [Qorvo](#) manufacturer:

Other Similar products are found below :

[A82-1](#) [BGA622H6820XTSA1](#) [BGA 728L7 E6327](#) [BGB719N7ESDE6327XTMA1](#) [HMC397-SX](#) [HMC405](#) [HMC561-SX](#) [HMC8120-SX](#)
[HMC8121-SX](#) [HMC-ALH382-SX](#) [HMC-ALH476-SX](#) [SE2433T-R](#) [SMA3101-TL-E](#) [SMA39](#) [A66-1](#) [A66-3](#) [A67-1](#) [LX5535LQ](#) [LX5540LL](#)
[MAAM02350](#) [HMC3653LP3BETR](#) [HMC549MS8GETR](#) [HMC-ALH435-SX](#) [SMA101](#) [SMA32](#) [SMA411](#) [SMA531](#) [SST12LP17E-XX8E](#)
[SST12LP19E-QX6E](#) [WPM0510A](#) [HMC5929LS6TR](#) [HMC5879LS7TR](#) [HMC1126](#) [HMC1087F10](#) [HMC1086](#) [HMC1016](#) [SMA1212](#)
[MAX2689EWS+T](#) [MAAMSS0041TR](#) [MAAM37000-A1G](#) [LTC6430AIUF-15#PBF](#) [CHA5115-QDG](#) [SMA70-2](#) [SMA4011](#) [A231](#) [HMC-](#)
[AUH232](#) [LX5511LQ](#) [LX5511LQ-TR](#) [HMC7441-SX](#) [HMC-ALH310](#)