

General Description

The Qorvo TGA2524-SM is a Ku-Band GaAs Power Amplifier. The TGA2524-SM operates from 11.3 – 16 GHz and is designed using Qorvo’s power pHEMT production process.

TGA2524-SM has a typical gain of 23dB, and can deliver 26.5 dBm of saturated output power and 26dBm at P1dB. It is a high linearity part with output TOI of 37dBm at 8dBm output per tone.

The TGA2524-SM is available in a low-cost, surface mount 16 lead 3x3 QFN overmold package and is ideally suited for Point-to-Point Radio applications.

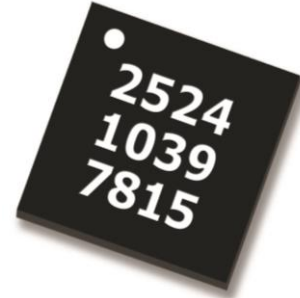

Product Features

- Frequency Range: 11.3 – 16 GHz
- Psat: 26.5 dBm
- P1dB: 26 dBm
- Gain: 23 dB, good gain flatness with regulation
- OTOI: 37 dBm at 8 dBm Pout/tone
- NF: 7 dB
- Bias: Vd = 5 V, Idq = 320 mA, Vg = -0.52 V Typical
- Package Dimensions: 3.0 x 3.0 x 0.85 mm

*Performance is typical across frequency.
Please reference electrical specification table and data plots for more details.*

Functional Block Diagram

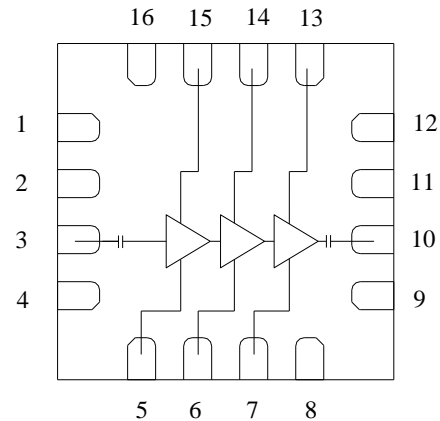

Applications

- Point-to-Point Radio
- Ku-band Sat-Com

Ordering Information

Part No.	Description
TGA2524-SM	TGA2524-SM, Driver Amplifier
1078986	TGA2524-SM Tape and Reel 7", Qty 1000
TGA2524-SMEVB02	TGA2424-SM Evaluation Board, Qty 1

Absolute Maximum Ratings

Parameter	Min Value	Max Value	Units
Drain Voltage, Vd	-	8	V
Gate Voltage, Vg	-2	0	V
Drain to Gate Voltage, Vd – Vg	-	12	V
Drain Current, Id	-	450	mA
Gate Current, Ig	-8.2	10	mA
Power Dissipation, Pdiss	-	3.6	W
RF Input Power, CW, T = 25°C	-	19	dBm
Channel Temperature, Tch	-	200	°C
Mounting Temperature (30 Seconds)	-	260	°C
Storage Temperature	-40	150	°C

Operation of this device outside the parameter ranges given above may cause permanent damage. These are stress ratings only, and functional operation of the device at these conditions is not implied. Extended application of Absolute Maximum Rating conditions may reduce device reliability.

Recommended Operating Conditions

Parameter	Value	Units
Drain Voltage	5	V
Drain Current (quiescent, Idq)	320	mA
Gate Voltage (typical)	-0.52	V
Operating Temperature Range	-40 to 85	°C

Electrical specifications are measured at specified test conditions. Specifications are not guaranteed over all recommended operating conditions.

Electrical Specifications

Test Conditions unless otherwise stated: V_D = 5V, I_{DQ} = 320mA, 25 °C. Data de-embedded to device reference planes

Parameter	Min	Typical	Max	Units
Frequency	11.3		16	GHz
Small Signal Gain (11.3 to 12 GHz)	16	20		dB
Small Signal Gain (12 to 16 GHz)	20	23		dB
Input Return Loss		-12	-8	dB
Output Return Loss		-15	-10	dB
Output Power at Saturation (11.3 to 12 GHz)	24	25		dBm
Output Power at Saturation (12 to 16 GHz)	25.5	26.5		dBm
Output Power at 1dB Compression (11.3 to 12 GHz)	23.5	24.5		dBm
Output Power at 1dB Compression (12 to 16 GHz)	25	26		dBm
Noise Figure		7		dB
Output TOI (@ Drain Current of 300 mA)		37		dBm
Gain Temperature Coefficient		-0.035		dB/°C
Power Temperature Coefficient		-0.007		dB/°C

Performance Plots – Small Signal

Test Conditions unless otherwise stated: $V_D = 5\text{ V}$, $I_{DQ} = 320\text{ mA}$, $25\text{ }^\circ\text{C}$.

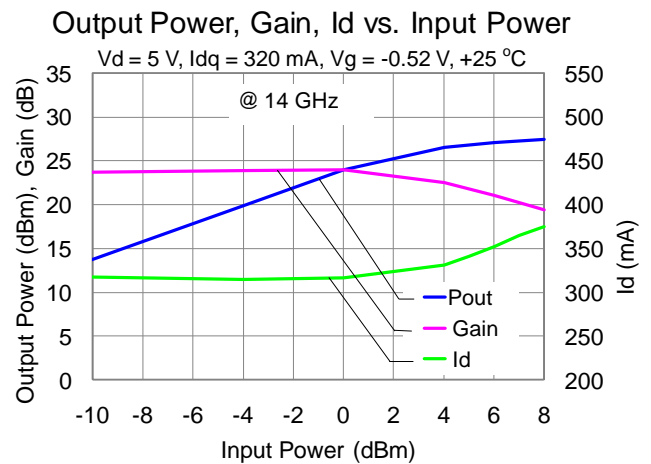
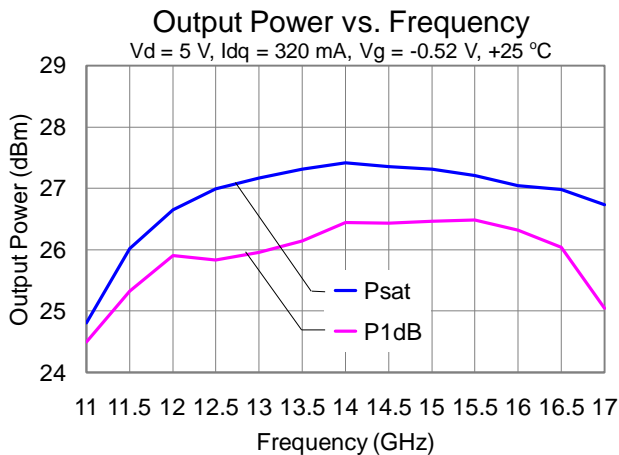
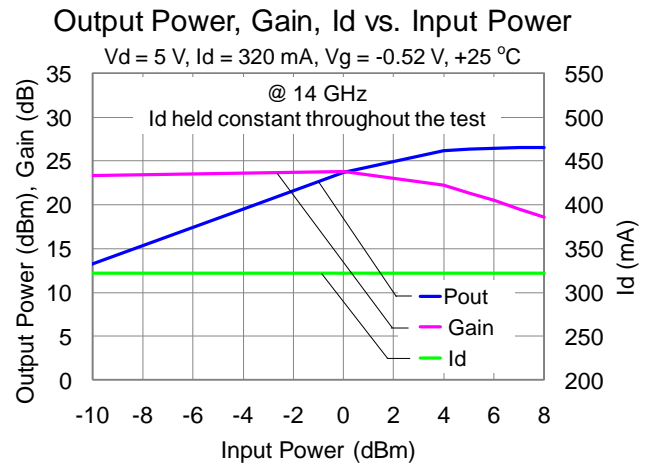
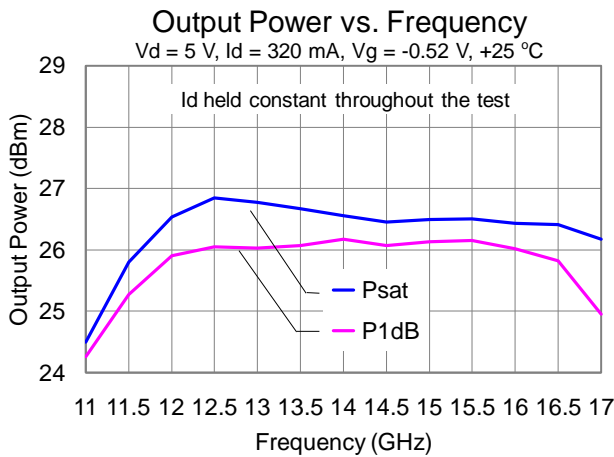
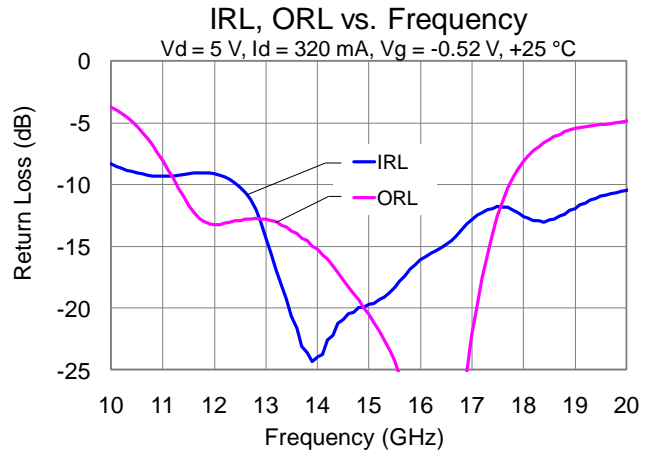
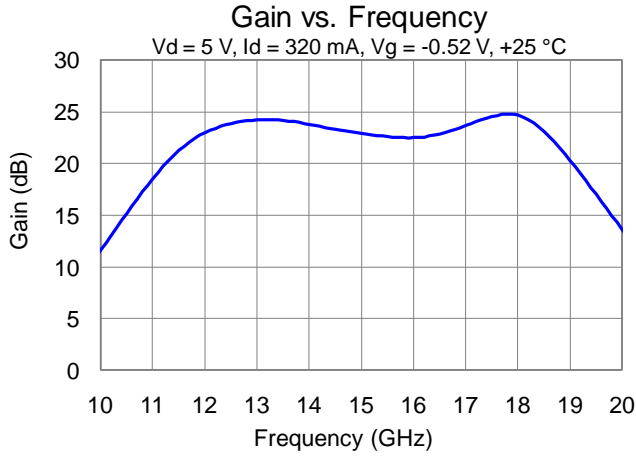

Performance Plots – Small Signal

Test Conditions unless otherwise stated: $V_D = 5\text{ V}$, $I_{DQ} = 320\text{ mA}$, $25\text{ }^\circ\text{C}$.

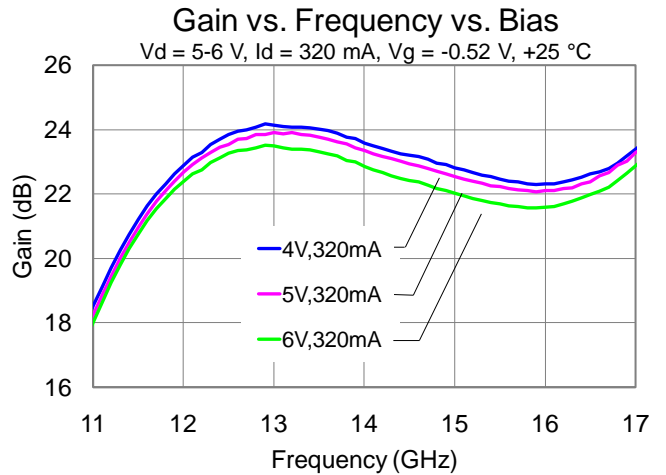
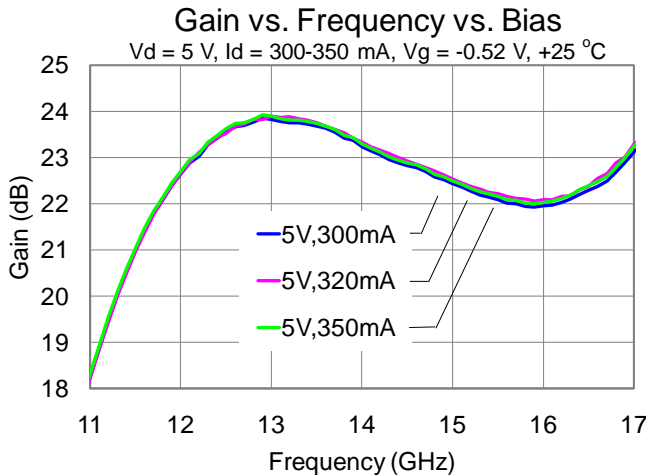
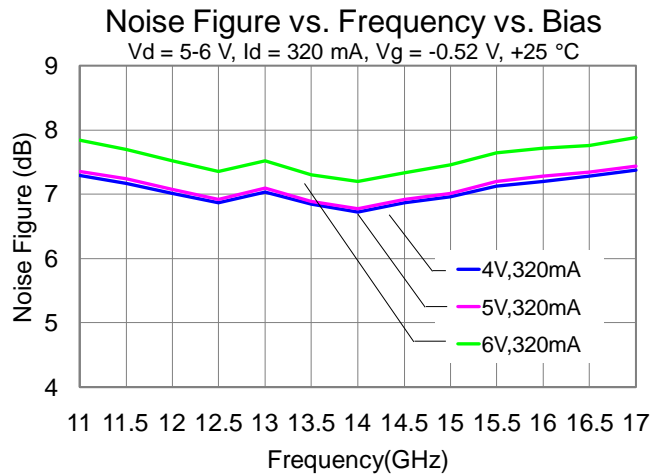
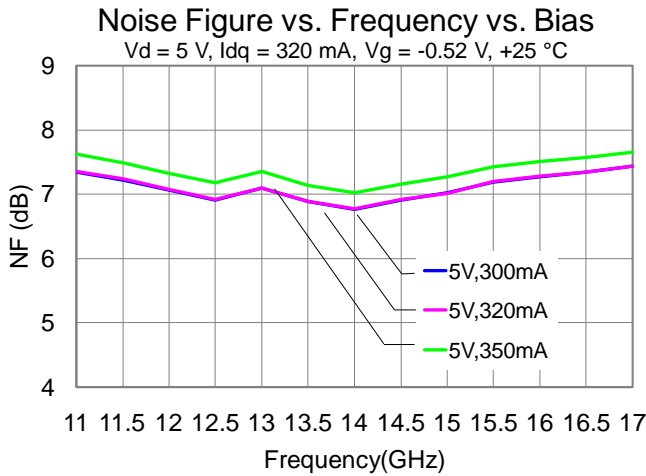
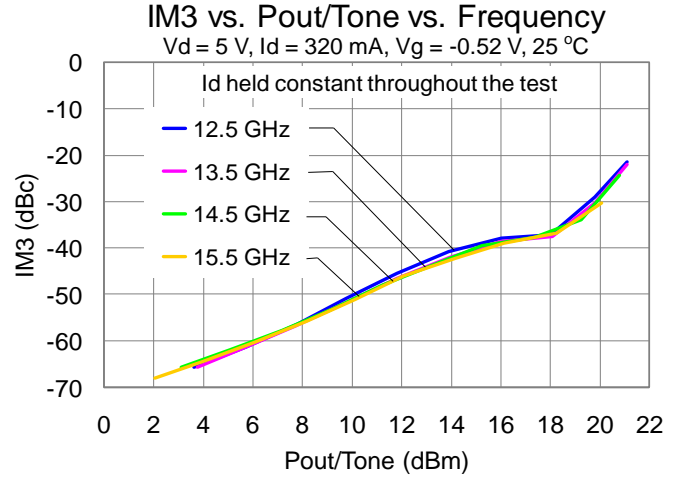
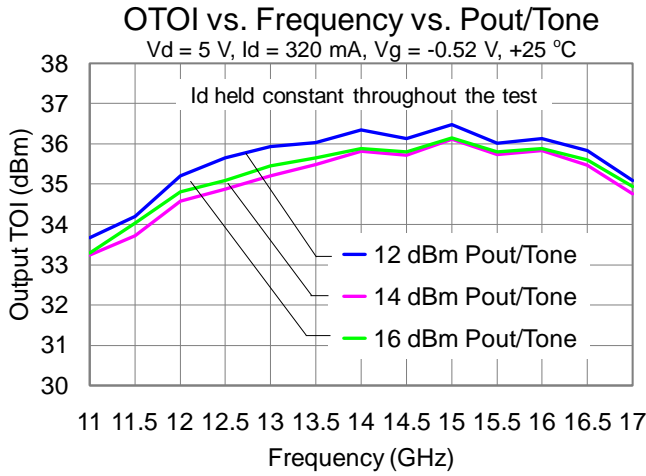

Performance Plots – Noise Figure

Test Conditions unless otherwise stated: $V_D = 5\text{ V}$, $I_{DQ} = 320\text{ mA}$, $25\text{ }^\circ\text{C}$.

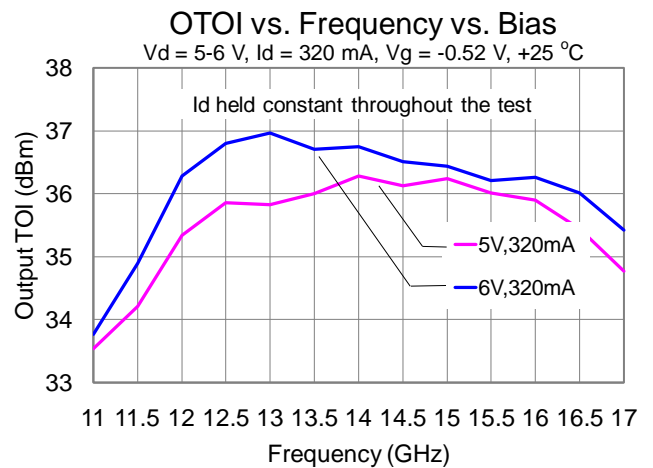
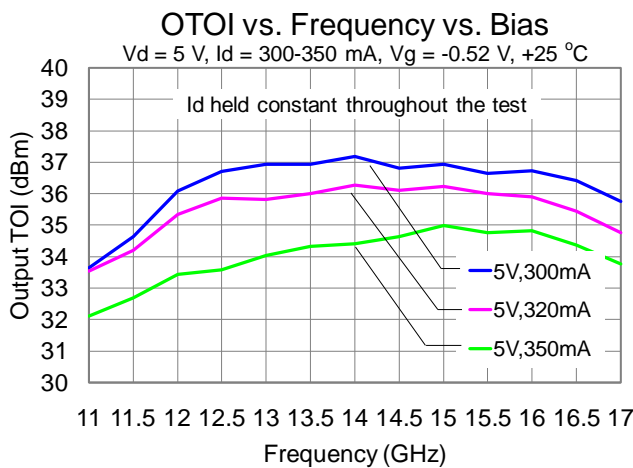
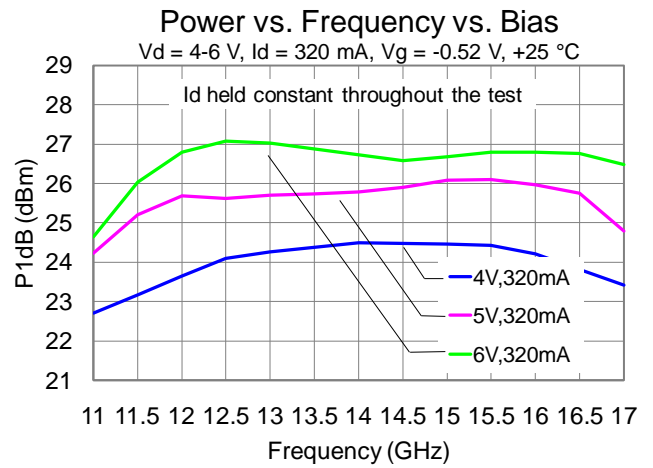
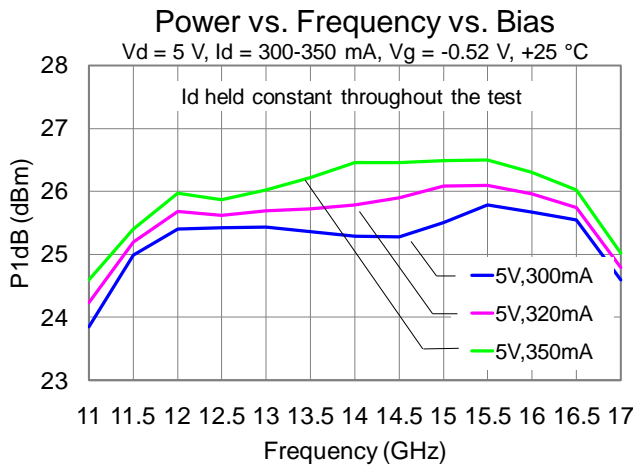
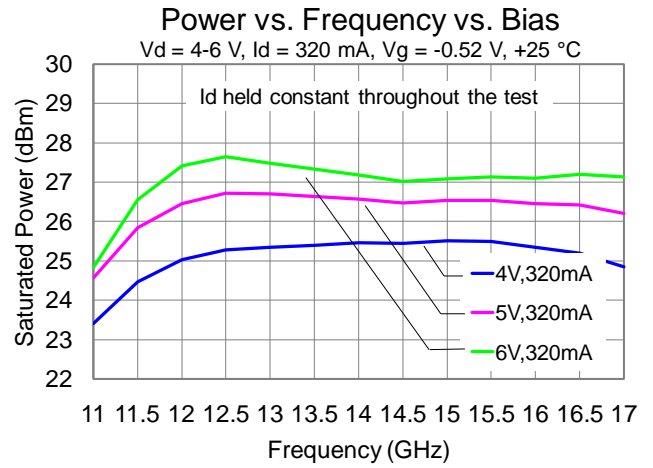
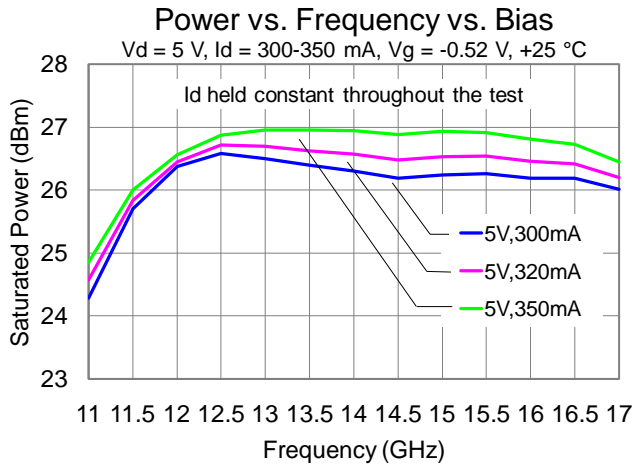

Performance Plots – Power

Test Conditions unless otherwise stated: $V_D = 5\text{ V}$, $I_{DQ} = 320\text{ mA}$, $25\text{ }^\circ\text{C}$.

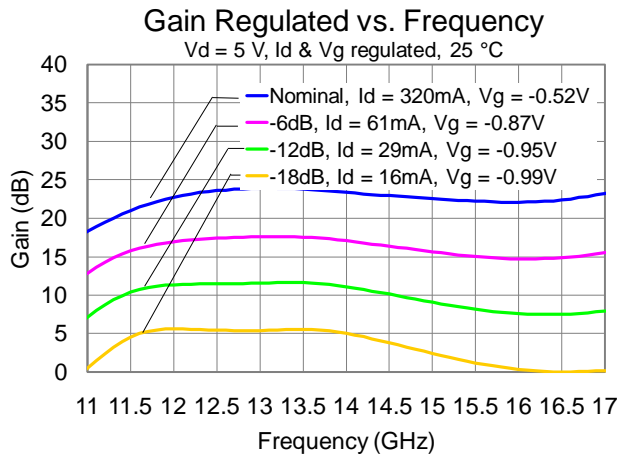
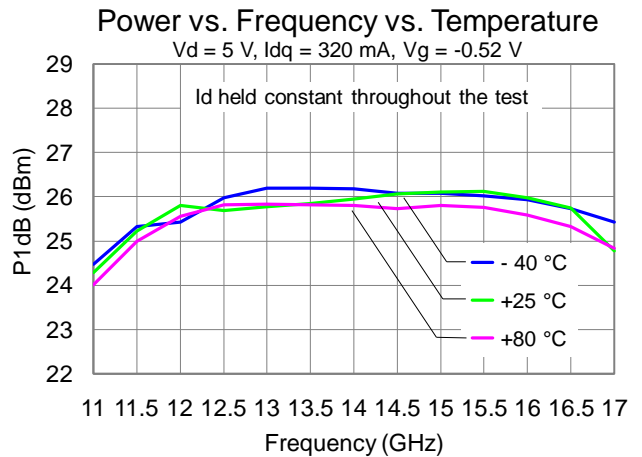
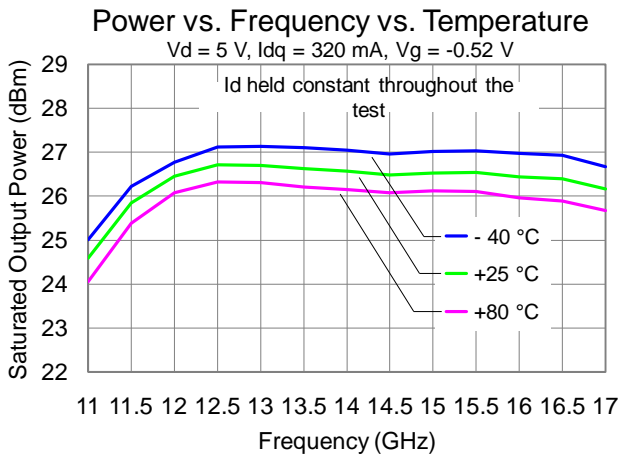
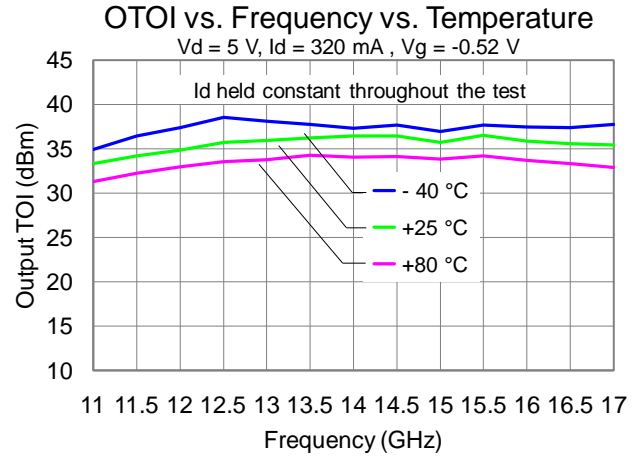
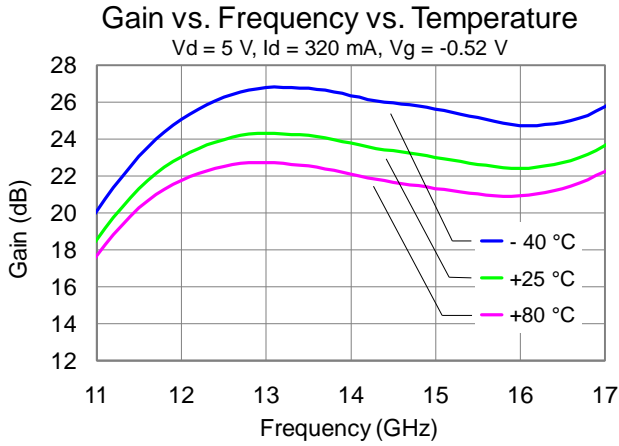

Application Circuit

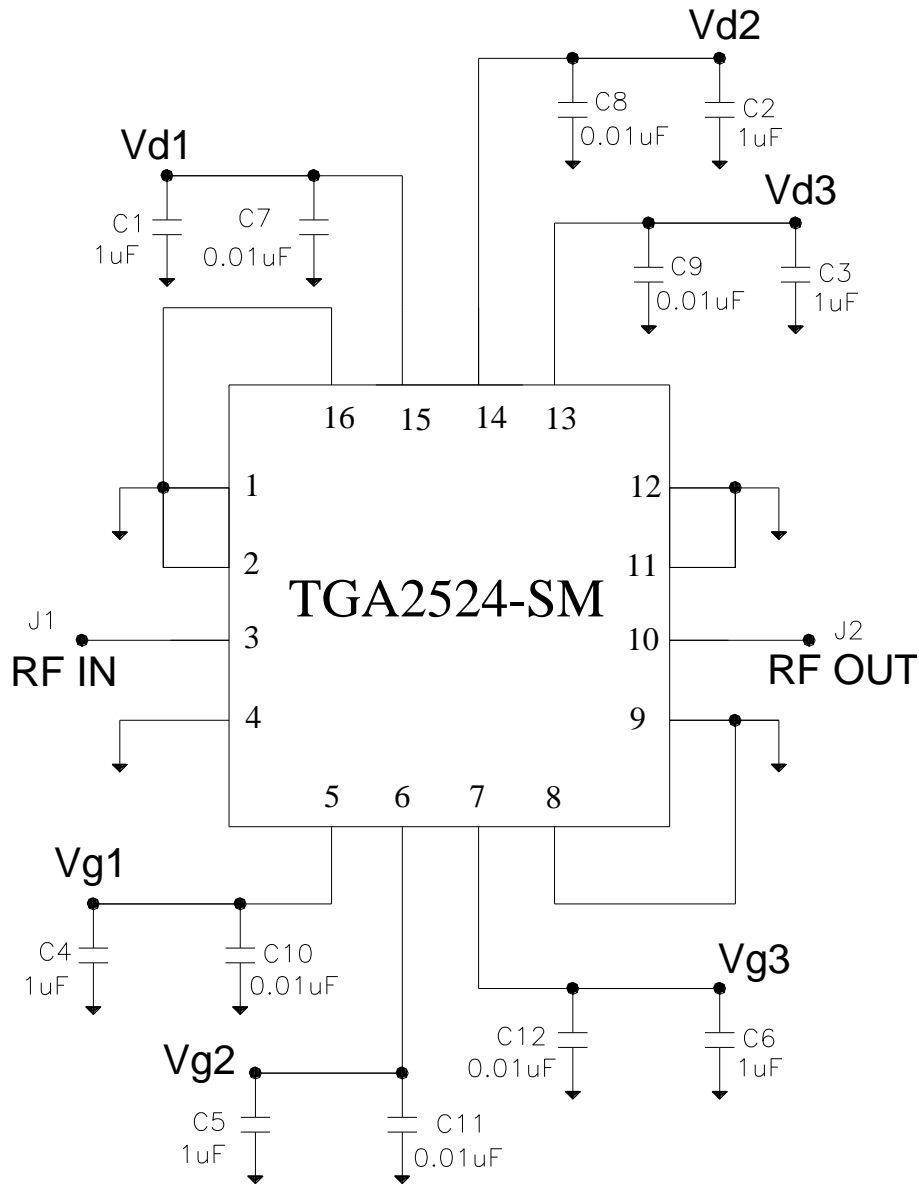

Bias-up Procedure

1. Vg (externally connect Vg1, Vg2, and Vg3 together) set to -1.5 V
2. Vd (externally connect Vd1, Vd2, and Vd3 together) set to +5 V
3. Adjust Vg more positive until quiescent current is 320 mA, Vg = -0.52 V typical
4. Apply RF signal to RF Input

Bias-down Procedure

1. Turn off RF signal
2. Reduce Vg to -1.5V. Ensure Id ~ 0 mA
3. Turn Vd to 0 V
4. Turn Vg to 0 V

Evaluation Board and Assembly

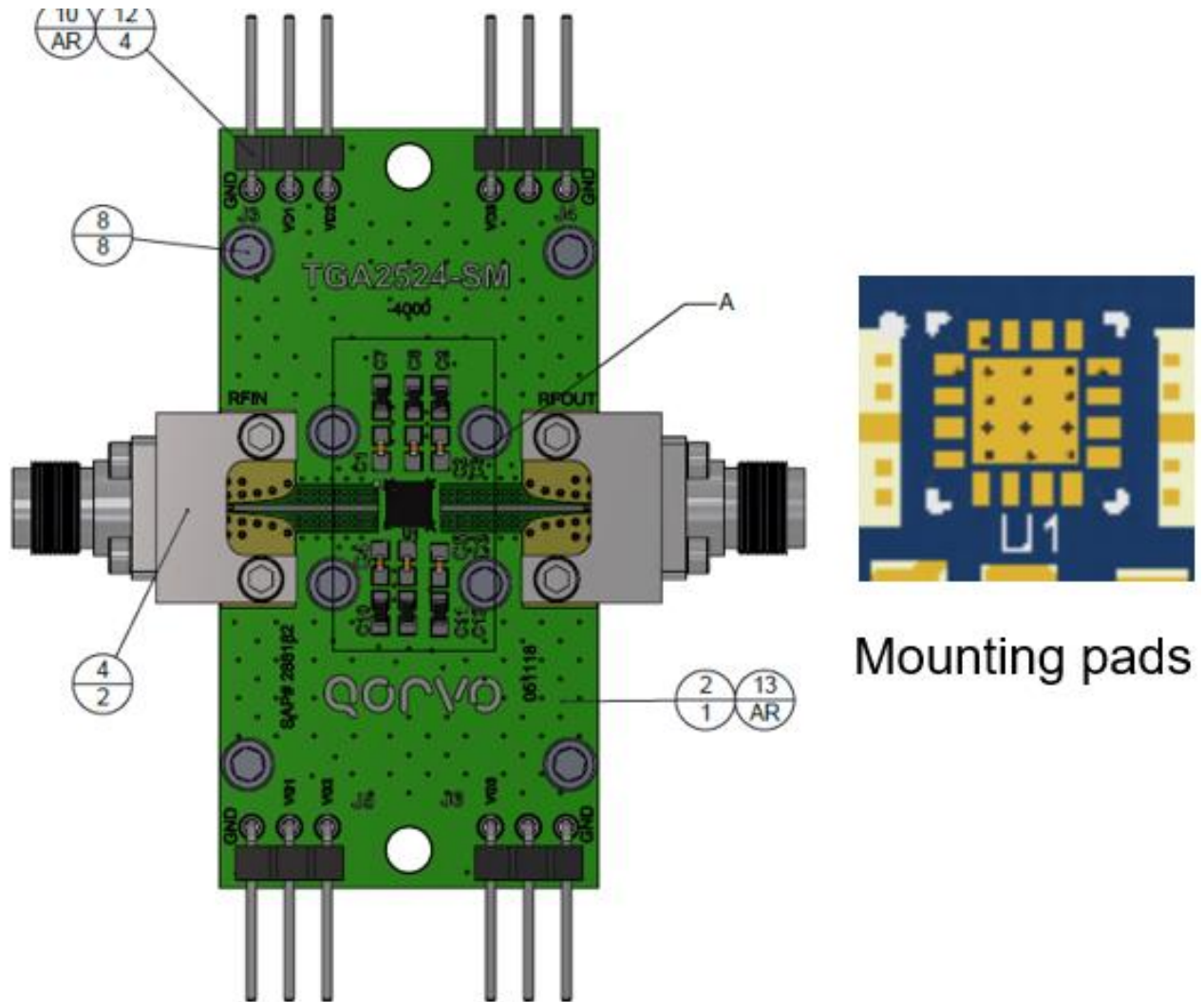

RF Layer is 0.008" thick Rogers Corp. RO4003C ($\epsilon_r = 3.35$). Metal layers are 0.5 oz. copper. The microstrip line at the connector interface is optimized for the Southwest Microwave end launch connector 1092-01A-5.

Bill of Materials

Ref. Des.	Component	Value	Manuf.	Part Number
C1 - C6	Surface Mount	CAP 1.0UF +/-5%, 16V, 1206, COG	AVX	12063C105KAT2A
C7 - C12	Surface Mount	CAP 0.01UF +/-5%, 16V, 0603, COG	AVX	06033C103KAT2A
J1, J2	RF Connector	2.92 MM RF CONNECTOR	Southwest Microwave	1092-01A-5

Mechanical Drawing & Pad Description

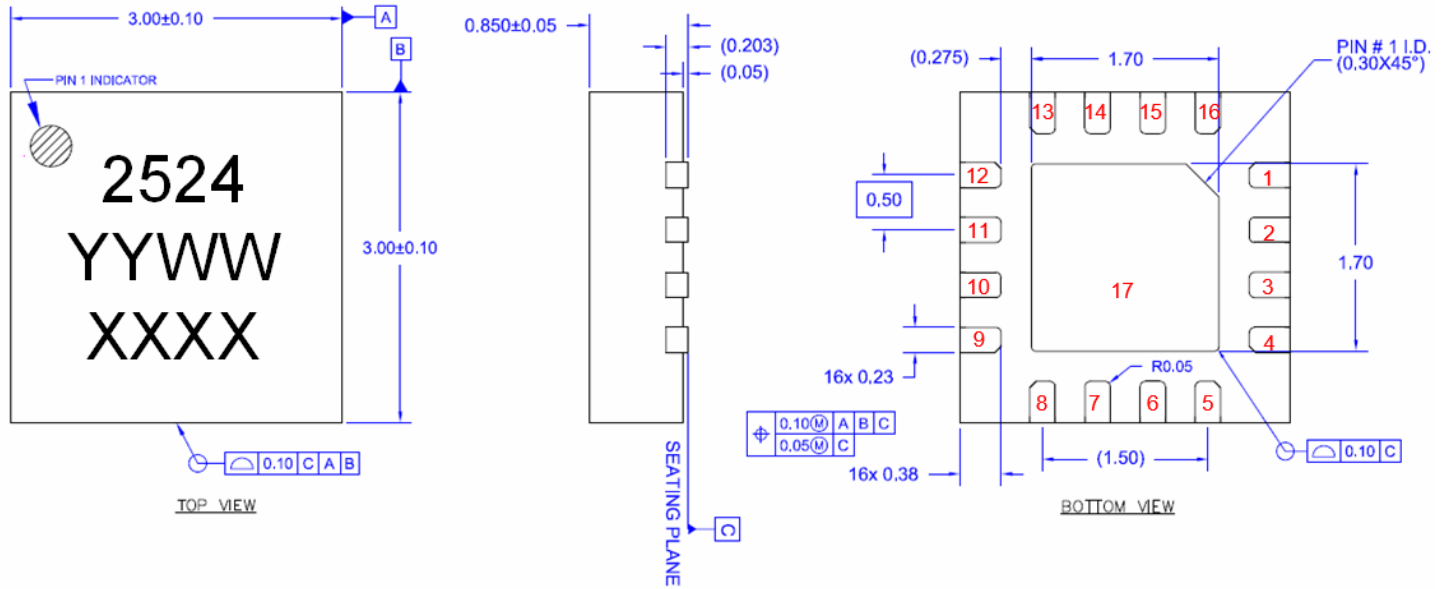

Dimensions in mm.

The package base is copper alloy and the plating material on the leads is matte Sn annealed.

Part Marking: 2524: Part Number, YY = Part Assembly Year, WW = Part Assembly Week, MXXX = Batch ID.

Pin Number	Label	Description
1, 2, 4, 8, 9, 11, 12, 16	N/C	No internal connection. Recommend to GND at the PCB level
3	RF IN	Matched to 50 ohms, DC blocked
5	Vg1	Gate Voltage; bias network is required (V_G can be tied together at PCB)
6	Vg2	Gate Voltage; bias network is required (V_G can be tied together at PCB)
7	Vg3	Gate Voltage; bias network is required (V_G can be tied together at PCB)
10	RF OUT	Matched to 50 ohms, DC blocked
13	Vd3	Drain Voltage; bias network is required (V_D can be tied together at PCB)
14	Vd2	Drain Voltage; bias network is required (V_D can be tied together at PCB)
15	Vd1	Drain Voltage; bias network is required (V_D can be tied together at PCB)
17	GND	Ground Pedestal

Thermal and Reliability Information

Parameter	Test Conditions	Value	Units
Thermal Resistance (θ_{JC}) ⁽¹⁾	Tbase = 90 °C	31.1	°C/W
Channel Temperature (T _{CH})	Vd = 5 V, Id = 320 mA, Quiescent	140	°C
Median Lifetime (T _M)	Pdiss = 1.6 W	2.4E06	Hrs
Thermal Resistance (θ_{JC}) ⁽¹⁾	Tbase = 90 °C	31.1	°C/W
Channel Temperature (T _{CH})	Vd = 5 V, Id = 375 mA, RF Pout = 26.5 dBm	134	°C
Median Lifetime (T _M)	Pdiss = 1.4 W	5.6E06	Hrs

Notes:

1. Thermal resistance is referenced to back of the package.

Median Lifetime

Test Conditions: $V_D = 4 V$
Failure Criteria = 10% reduction in I_{D_MAX}

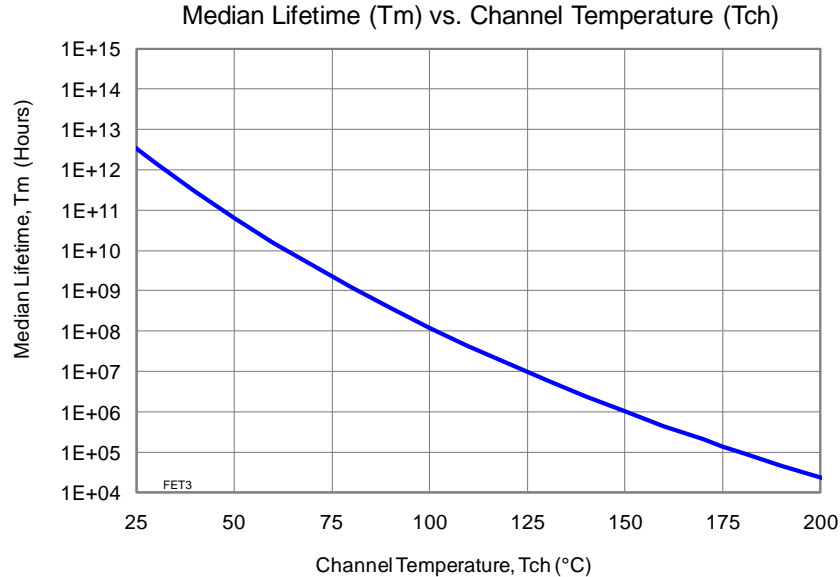

Solderability

- Compatible with the latest version of J-STD-020, Lead-free solder (maximum 260 °C reflow temperature) and tin-lead (maximum 245 °C reflow temperature) soldering processes.

Recommended Soldering Temperature Profile

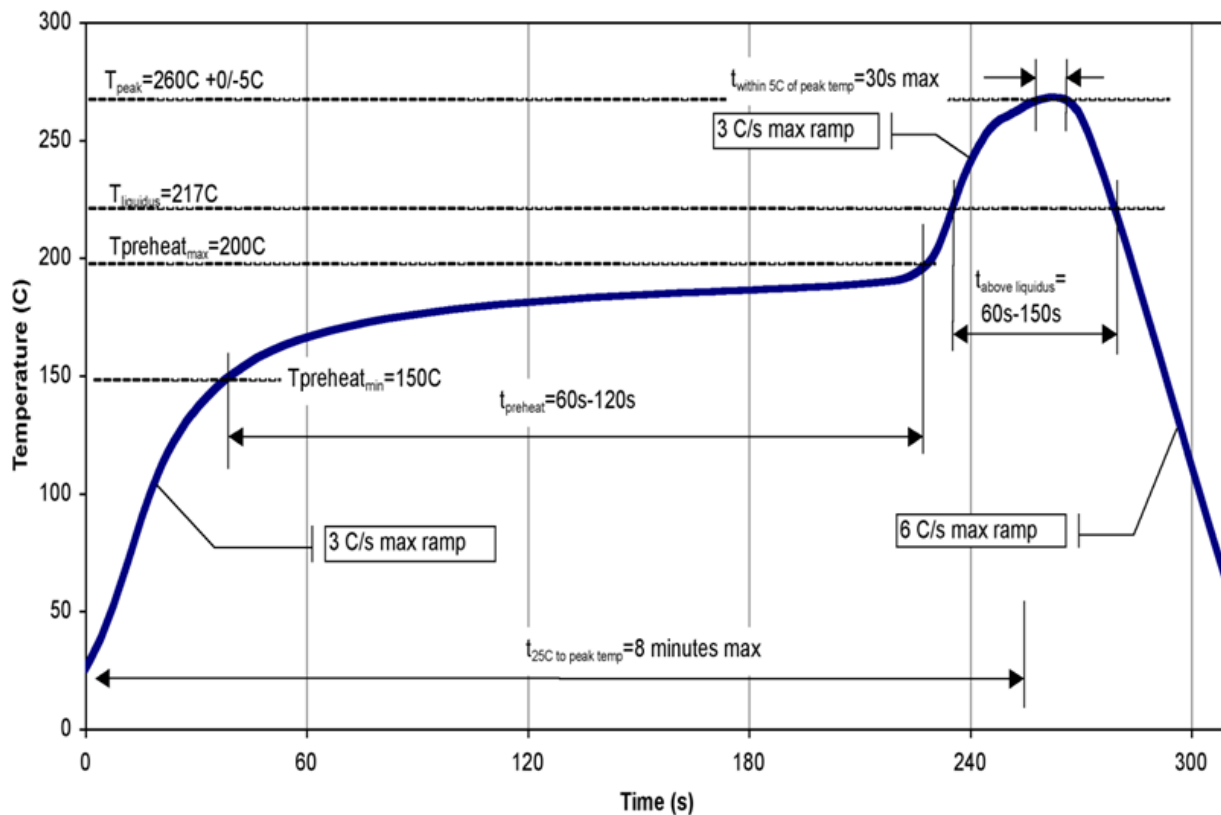

Tape and Reel Information

Standard T/R size = 1000 pieces on a 7" x 0.5" reel.

Material		Cavity (mm)				Distance Between Centerline (mm)		Carrier Tape (mm)	Cover Carrier (mm)
Vendor	Vendor P/N	Length (A0)	Width (B0)	Depth (K0)	Pitch (P1)	Length direction (P2)	Width Direction (F)	Width (W)	Width (W)
C-Pack	QFN0400 X 0400D	3.4	3.2	1.4	4.0	2.0	3.5	8.0	5.4

Carrier and Cover Tape Physical Dimensions

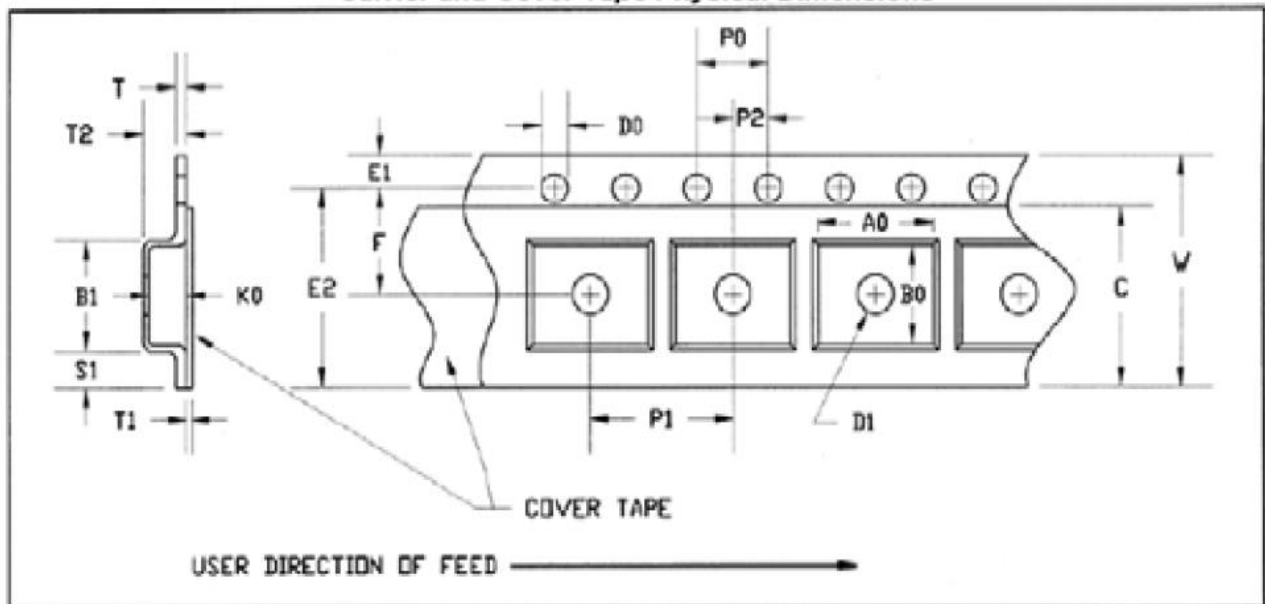

Handling Precautions

Parameter	Rating	Standard
ESD – Human Body Model (HBM)	1A	ESDA / JEDEC JS-001-2012
ESD – Charged Device Model (CDM)	TBD	ESDA / JEDEC JS-002-2014
MSL – Convection Reflow 260 °C	1	JEDEC standard IPC/JEDEC J-STD-020



Caution!
ESD-Sensitive Device

RoHS Compliance

This product is compliant with the 2011/65/EU RoHS directive (Restrictions on the Use of Certain Hazardous Substances in Electrical and Electronic Equipment), as amended by Directive 2015/863/EU.

This product also has the following attributes:

- Lead Free
- Halogen Free (Chlorine, Bromine)
- Antimony Free
- TBBP-A (C₁₅H₁₂Br₄O₂) Free
- SVHC Free

Contact Information

For the latest specifications, additional product information, worldwide sales and distribution locations:

Tel: 1-844-890-8163

Web: www.qorvo.com

Email: customer.support@qorvo.com

Important Notice

The information contained herein is believed to be reliable; however, Qorvo makes no warranties regarding the information contained herein and assumes no responsibility or liability whatsoever for the use of the information contained herein. All information contained herein is subject to change without notice. Customers should obtain and verify the latest relevant information before placing orders for Qorvo products. The information contained herein or any use of such information does not grant, explicitly or implicitly, to any party any patent rights, licenses, or any other intellectual property rights, whether with regard to such information itself or anything described by such information. **THIS INFORMATION DOES NOT CONSTITUTE A WARRANTY WITH RESPECT TO THE PRODUCTS DESCRIBED HEREIN, AND QORVO HEREBY DISCLAIMS ANY AND ALL WARRANTIES WITH RESPECT TO SUCH PRODUCTS WHETHER EXPRESS OR IMPLIED BY LAW, COURSE OF DEALING, COURSE OF PERFORMANCE, USAGE OF TRADE OR OTHERWISE, INCLUDING THE IMPLIED WARRANTIES OF MERCHANTABILITY AND FITNESS FOR A PARTICULAR PURPOSE.**

Without limiting the generality of the foregoing, Qorvo products are not warranted or authorized for use as critical components in medical, life-saving, or life-sustaining applications, or other applications where a failure would reasonably be expected to cause severe personal injury or death.

Copyright 2020 © Qorvo, Inc. | Qorvo is a registered trademark of Qorvo, Inc.

X-ON Electronics

Largest Supplier of Electrical and Electronic Components

Click to view similar products for [RF Amplifier](#) category:

Click to view products by [Qorvo](#) manufacturer:

Other Similar products are found below :

[A82-1](#) [BGA622H6820XTSA1](#) [BGA 728L7 E6327](#) [BGB719N7ESDE6327XTMA1](#) [HMC397-SX](#) [HMC405](#) [HMC561-SX](#) [HMC8120-SX](#)
[HMC8121-SX](#) [HMC-ALH382-SX](#) [HMC-ALH476-SX](#) [SE2433T-R](#) [SMA3101-TL-E](#) [SMA39](#) [A66-1](#) [A66-3](#) [A67-1](#) [LX5535LQ](#) [LX5540LL](#)
[MAAM02350](#) [HMC3653LP3BETR](#) [HMC549MS8GETR](#) [HMC-ALH435-SX](#) [SMA101](#) [SMA32](#) [SMA411](#) [SMA531](#) [SST12LP19E-QX6E](#)
[WPM0510A](#) [HMC5929LS6TR](#) [HMC5879LS7TR](#) [HMC1126](#) [HMC1087F10](#) [HMC1086](#) [HMC1016](#) [SMA1212](#) [MAX2689EWS+T](#)
[MAAMSS0041TR](#) [MAAM37000-A1G](#) [LTC6430AIUF-15#PBF](#) [CHA5115-QDG](#) [SMA70-2](#) [SMA4011](#) [A231](#) [HMC-AUH232](#) [LX5511LQ](#)
[LX5511LQ-TR](#) [HMC7441-SX](#) [HMC-ALH310](#) [XD1001-BD-000V](#)