

Applications

- Commercial and military radar

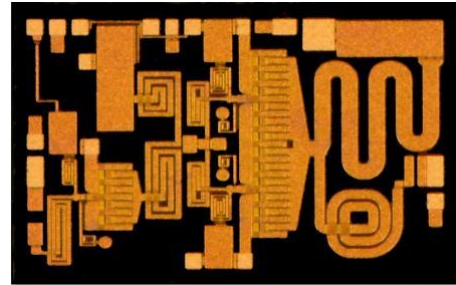

Product Features

- Frequency Range: 2.7 – 3.7GHz
- P_{SAT} : 40.5dBm at 25V
- PAE: 54%
- Small Signal Gain: 33dB
- Input Return Loss: >18dB
- Output Return Loss: >12dB
- Bias: $V_D = 25-32V$ (CW or Pulsed), $I_{DQ} = 175mA$, $V_G = -2.3V$ Typical
- Pulsed V_D : PP = 1ms, DC = 10%
- Chip Dimensions: 3.0 x 1.9 x 0.10 mm

Functional Block Diagram

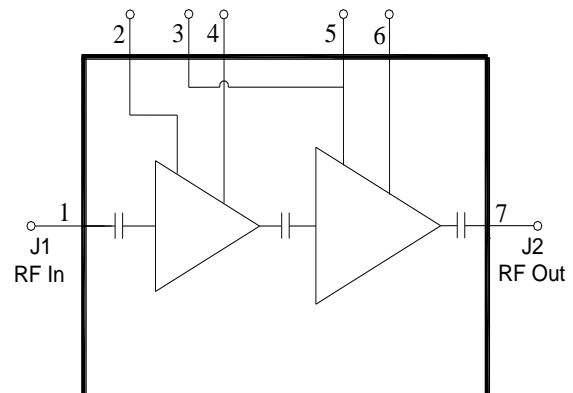

General Description

TriQuint's TGA2583 is an S-band MMIC amplifier fabricated on TriQuint's production 0.25um GaN on SiC process (TQGaN25). Covering 2.7-3.7GHz, the TGA2583 provides 10W of saturated output power and 33dB of small signal gain while achieving 54% power-added efficiency. Higher power can be achieved at the expense of PAE by increasing the drain voltage.

The TGA2583 is ideal for phase array S-band radars and can support both short pulse and CW conditions.

Both RF ports have integrated DC blocking capacitors and are fully matched to 50ohms.

Lead-free and RoHS compliant.

Pad Configuration

Pad No.	Symbol
1	RF In
2	V_{G1}
3, 5	V_{G2}
4	V_{D1}
6	V_{D2}
7	RF Out

Ordering Information

Part	ECCN	Description
TGA2583	3A001.b.2.a	2.7 – 3.7GHz 10W GaN Power Amplifier

Absolute Maximum Ratings

Parameter	Value
Drain Voltage (V_D)	40V
Gate Voltage Range (V_G)	-8 to 0V
Drain Current (I_{D1})	285mA
Drain Current (I_{D2})	1250mA
Gate Current (I_{G1})	-1.4 to 2.8mA
Gate Current (I_{G2})	-4.0 to 8.4mA
Power Dissipation (P_{DISS}), 85°C	25W
Input Power (P_{IN}), CW, 50 Ω , 85°C,	30dBm
Input Power (P_{IN}), CW, VSWR 10:1, $V_D = 28V$, 85°C	23dBm
Channel Temperature (T_{CH})	275°C
Mounting Temperature (30 Seconds)	320°C
Storage Temperature	-55 to 150°C

Operation of this device outside the parameter ranges given above may cause permanent damage. These are stress ratings only, and functional operation of the device at these conditions is not implied.

Recommended Operating Conditions

Parameter	Value
Drain Voltage (V_D)	25V
Drain Current (I_{DQ})	175mA (Total)
Gate Voltage (V_G)	-2.3V (Typ.)

Electrical specifications are measured at specified test conditions. Specifications are not guaranteed over all recommended operating conditions.

Electrical Specifications

Test conditions unless otherwise noted: 25°C, $V_D = 25V$, $I_{DQ} = 175mA$, $V_G = -2.3V$ Typical, Pulsed V_D : PP = 1ms, DC = 10%

Parameter	Min	Typical	Max	Units
Operational Frequency Range	2.7		3.7	GHz
Small Signal Gain		33		dB
Input Return Loss		>18		dB
Output Return Loss		>12		dB
Output Power ($P_{in} = 16dBm$)		40.5		dBm
Power Added Efficiency ($P_{in} = 16dBm$)		54		%
IM3 @ $P_{OUT}/Tone = 30dBm$		-25		dBc
IM5 @ $P_{OUT}/Tone = 30dBm$		-35		dBc
Small Signal Gain Temperature Coefficient		-0.05		dB/°C
Output Power Temperature Coefficient		-0.005		dBm/°C
Recommended Operating Voltage:		25	32	V

Thermal and Reliability Information

Parameter	Test Conditions	Value	Units
Thermal Resistance (θ_{JC}) ⁽¹⁾	$T_{base} = 85^{\circ}C, V_D = 25V, I_{DQ} = 175mA$ Pulsed V_D: PP = 1ms, DC = 10%	3.51	$^{\circ}C/W$
Channel Temperature (T_{CH}) (Under RF drive)	$T_{base} = 85^{\circ}C, V_D = 25V, I_{D_Drive} = 915mA,$	126	$^{\circ}C$
Median Lifetime (T_M)	$P_{IN} = 16dBm, P_{OUT} = 40.5dBm, P_{DISS} = 11.7W$	2.9×10^{11}	Hrs
Thermal Resistance (θ_{JC}) ⁽¹⁾	$T_{base} = 85^{\circ}C, V_D = 32V, I_{DQ} = 175mA$ Pulsed V_D: PP = 1ms, DC = 10%	4.68	$^{\circ}C/W$
Channel Temperature (T_{CH}) (Under RF drive)	$T_{base} = 85^{\circ}C, V_D = 32V, I_{D_Drive} = 1035mA,$	169	$^{\circ}C$
Median Lifetime (T_M)	$P_{IN} = 16dBm, P_{OUT} = 41.8dBm, P_{DISS} = 17.9W$	2.36×10^9	Hrs
Thermal Resistance (θ_{JC}) ⁽¹⁾	$T_{base} = 85^{\circ}C, V_D = 25V, I_{DQ} = 175mA, CW$	5.15	$^{\circ}C/W$
Channel Temperature (T_{CH}) (Under RF drive)	$T_{base} = 85^{\circ}C, V_D = 25V, I_{D_Drive} = 850mA,$	140	$^{\circ}C$
Median Lifetime (T_M)	$P_{IN} = 16dBm, P_{OUT} = 40.3dBm, P_{DISS} = 10.6W$	5.43×10^9	Hrs
Thermal Resistance (θ_{JC}) ⁽¹⁾	$T_{base} = 85^{\circ}C, V_D = 32V, I_{DQ} = 175mA, CW$	7.1	$^{\circ}C/W$
Channel Temperature (T_{CH}) (Under RF drive)	$T_{base} = 85^{\circ}C, V_D = 32V, I_{D_Drive} = 970mA,$	202	$^{\circ}C$
Median Lifetime (T_M)	$P_{IN} = 16dBm, P_{OUT} = 41.6dBm, P_{DISS} = 16.5W$	1.06×10^7	Hrs

Notes:

1. Thermal resistance measured to back of carrier plate. MMIC mounted on 40 mils CuMo (80/20) carrier using 1.5 mil AuSn.

Median Lifetime

Test Conditions: $V_D = 40 V$; Failure Criteria = 10% reduction in I_{D_MAX}

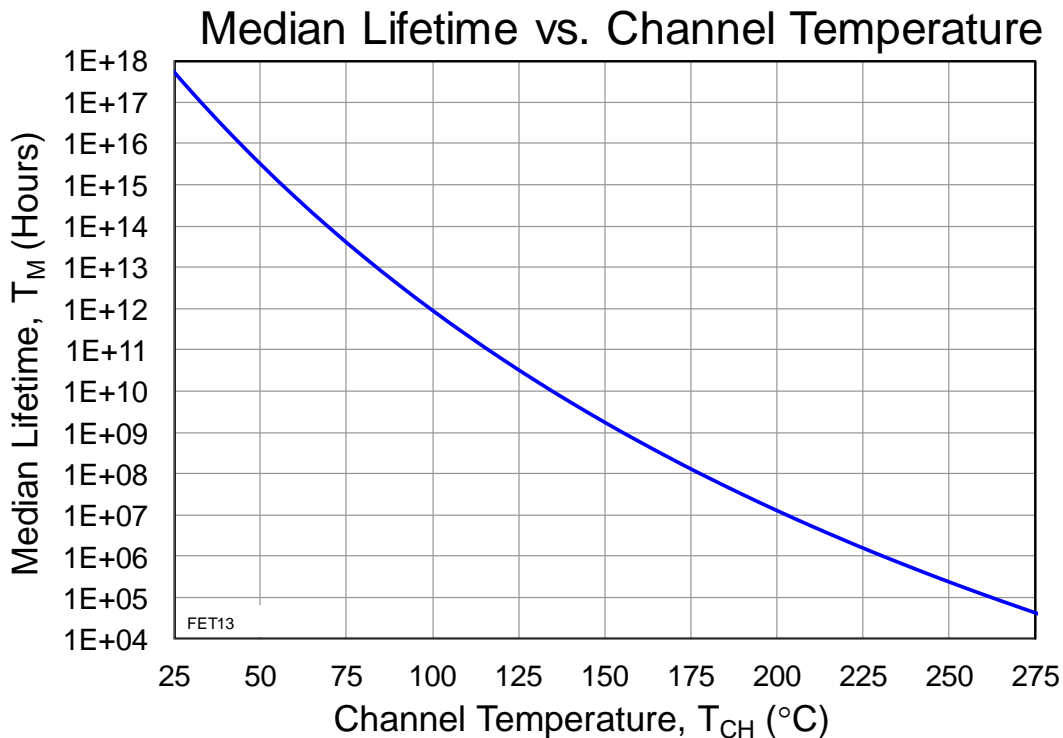

Typical Performance (Small Signal)

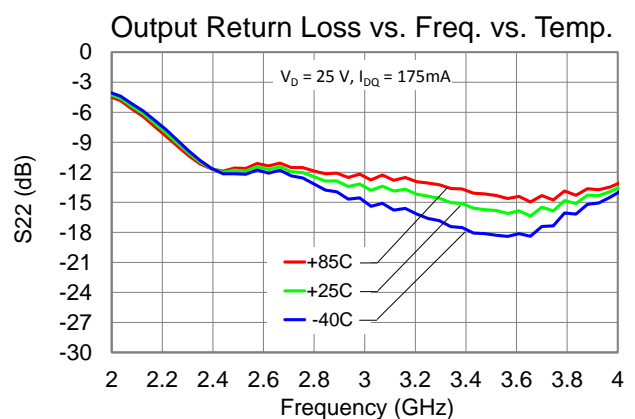
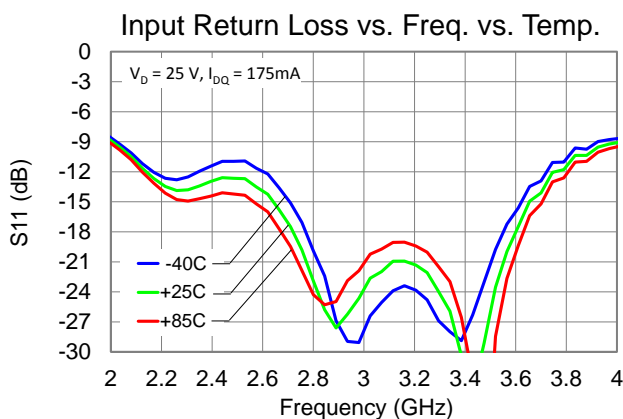
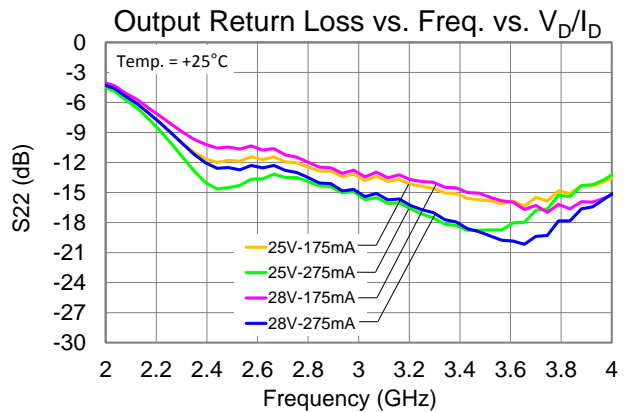
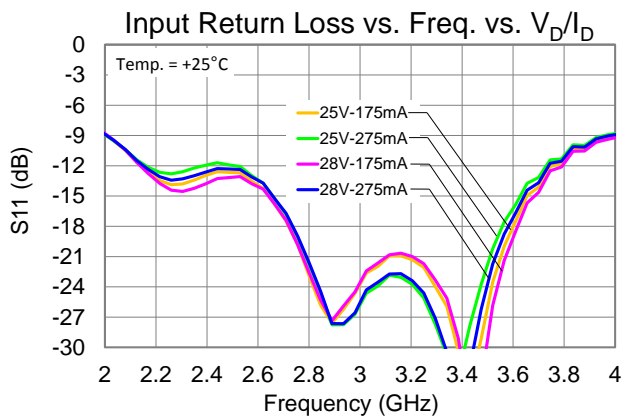
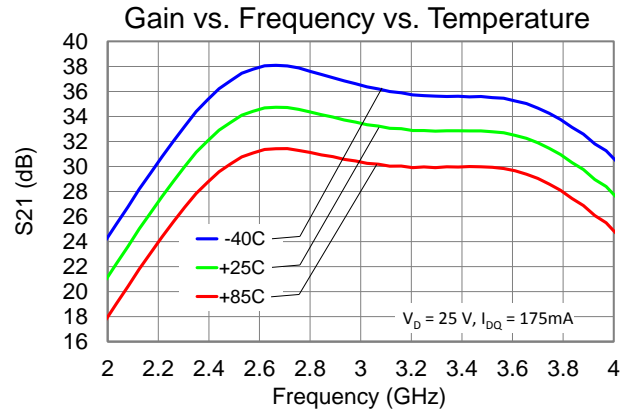
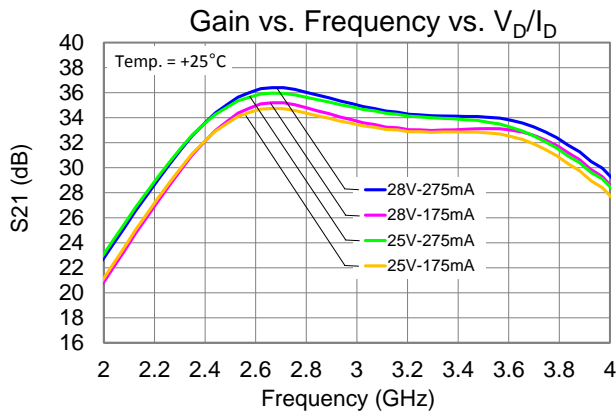

Typical Performance (Pulsed Operation)

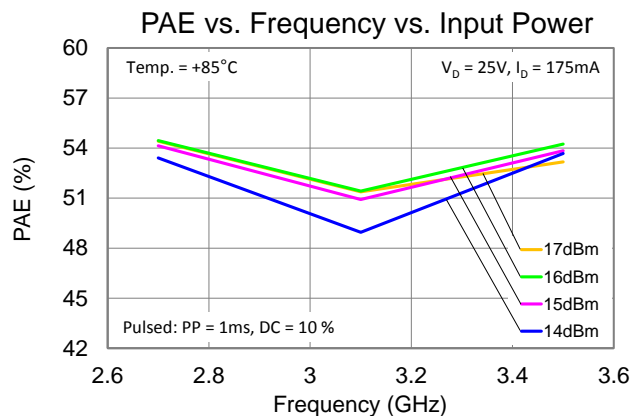
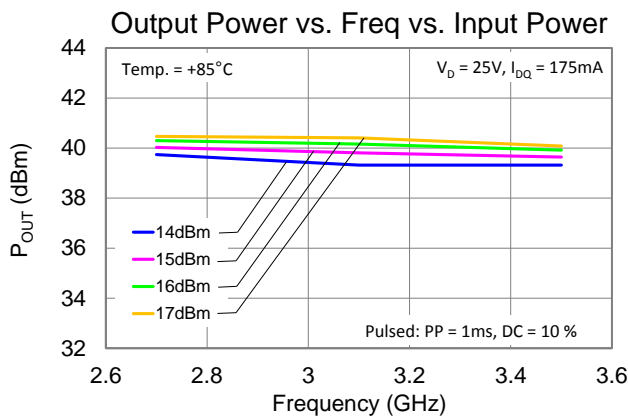
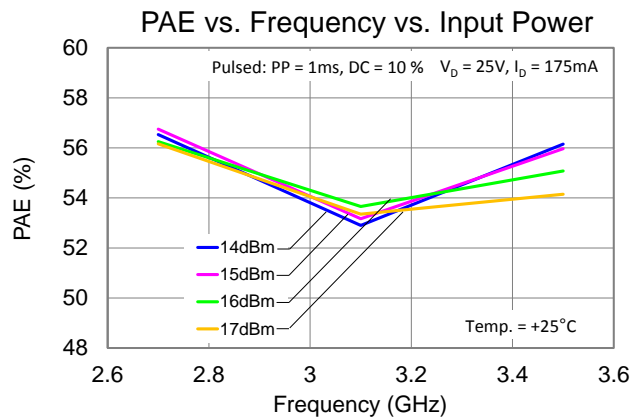
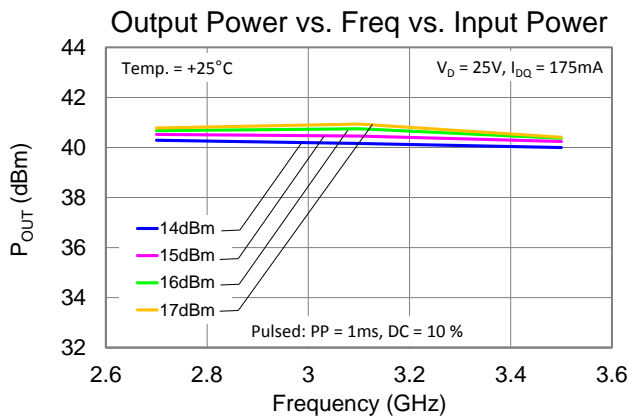
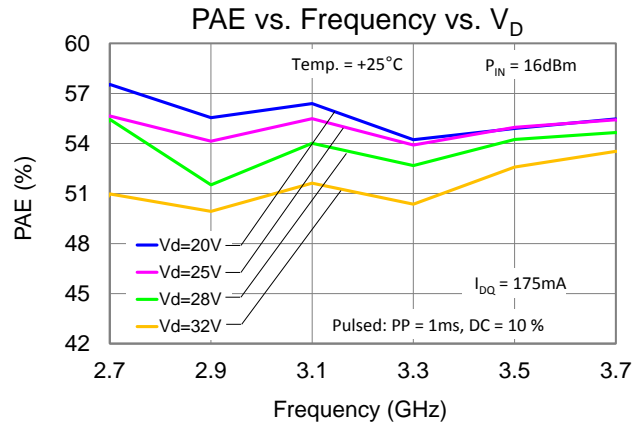
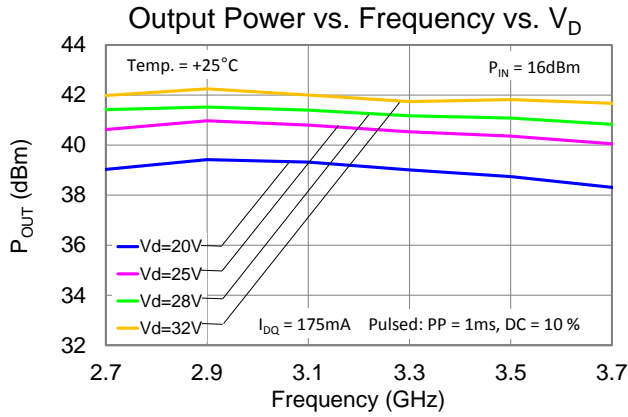

Typical Performance (Pulsed Operation)

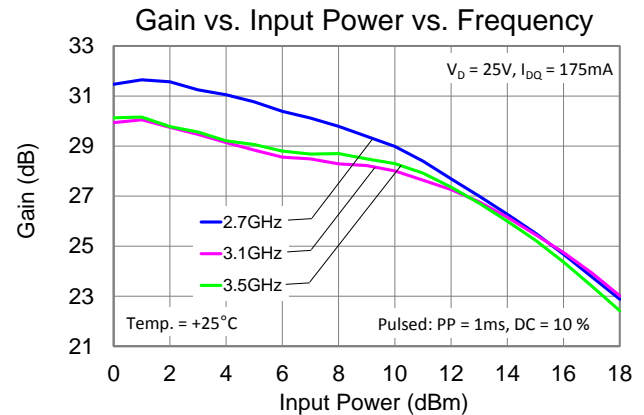
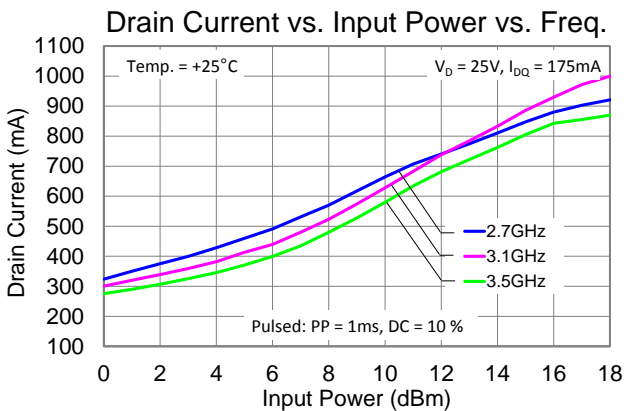
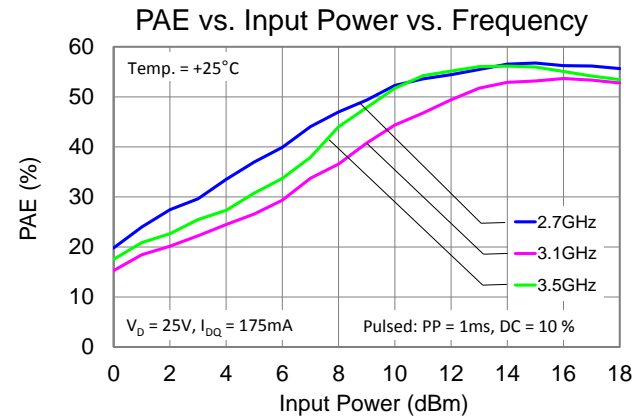
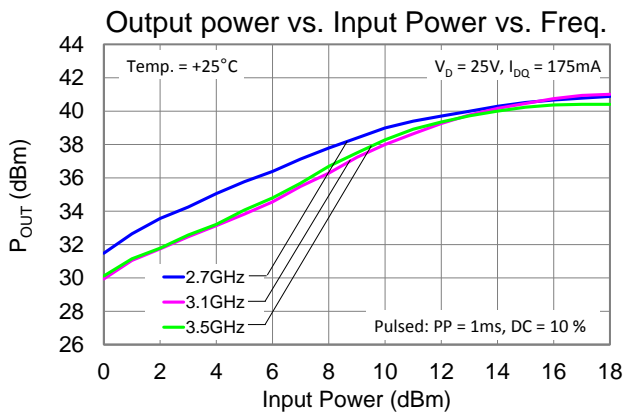
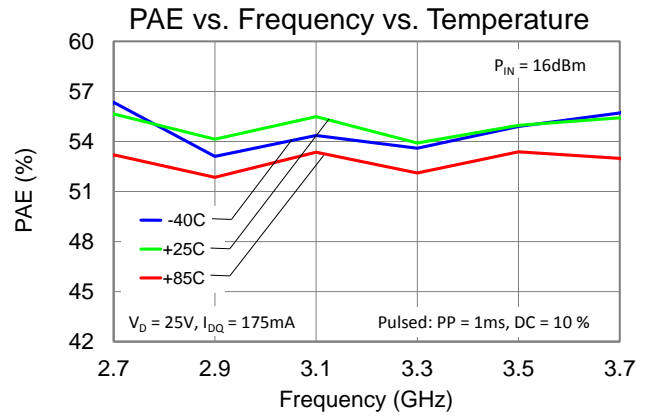
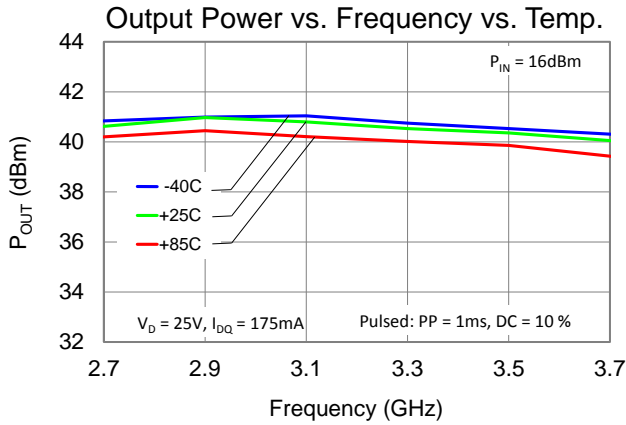

Typical Performance (CW Operation)

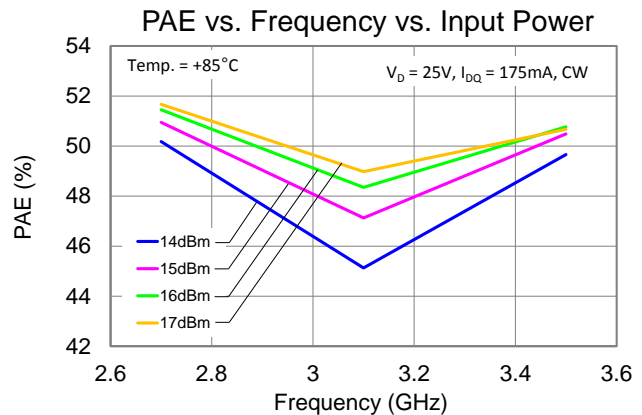
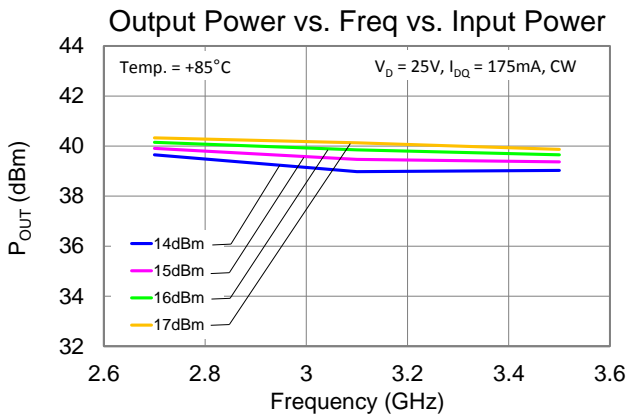
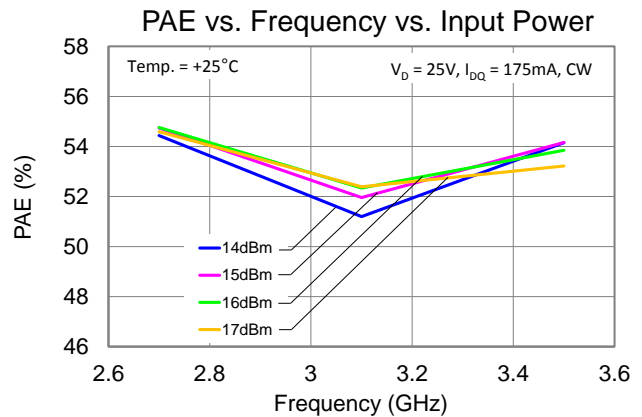
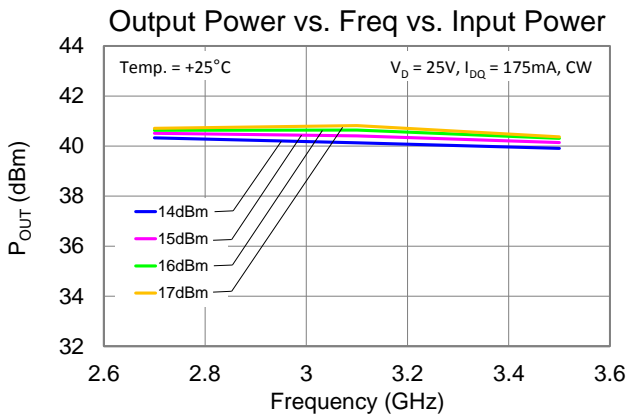
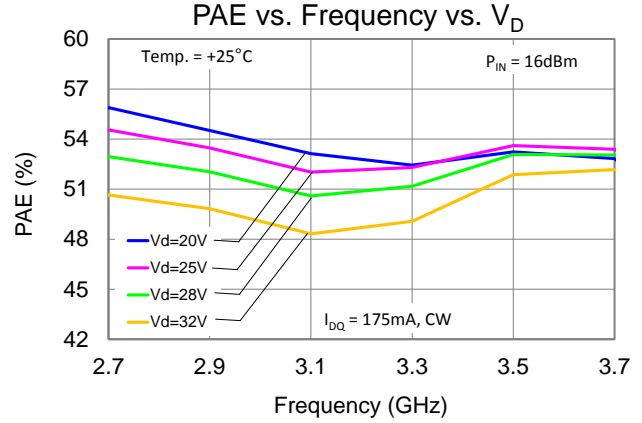
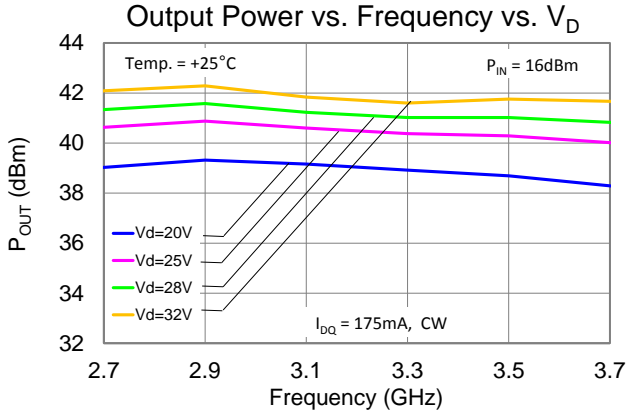

Typical Performance (CW Operation)

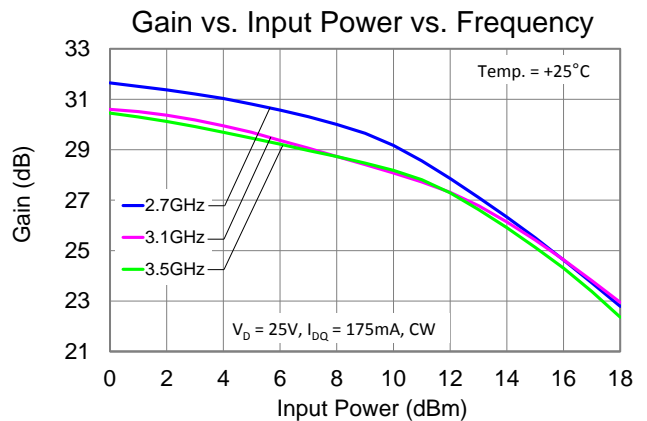
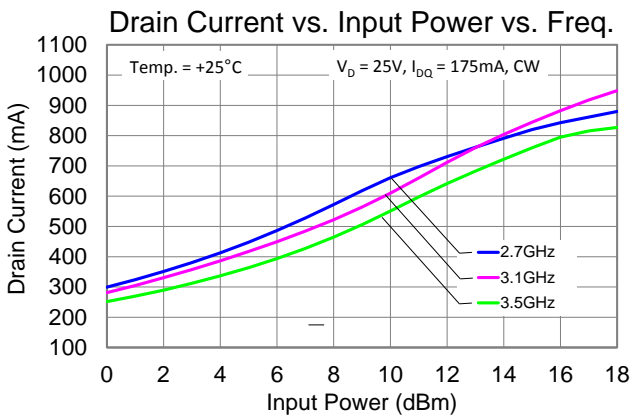
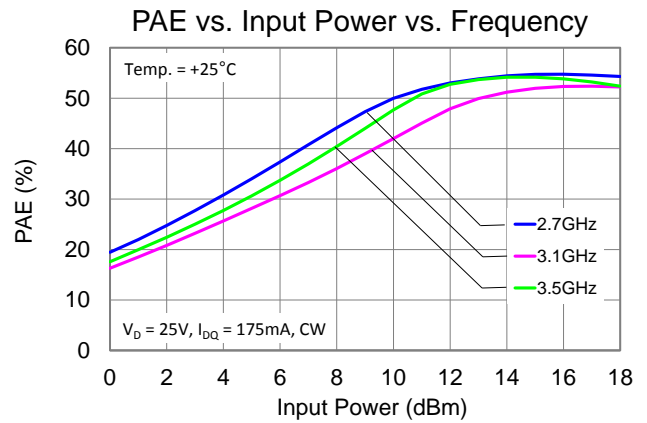
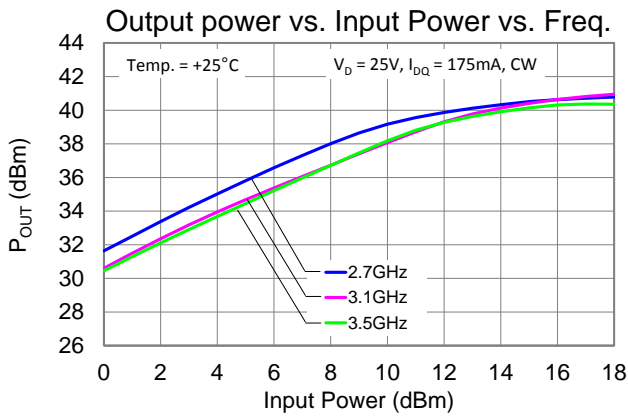
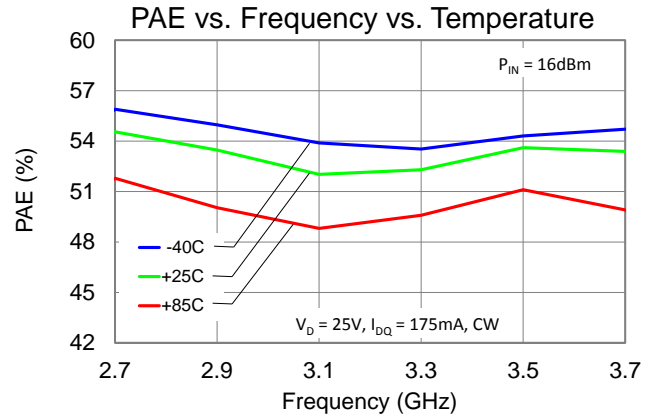
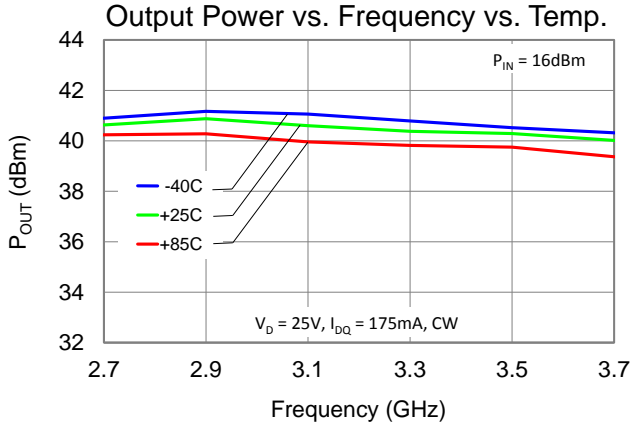

Typical Performance (Linearity)

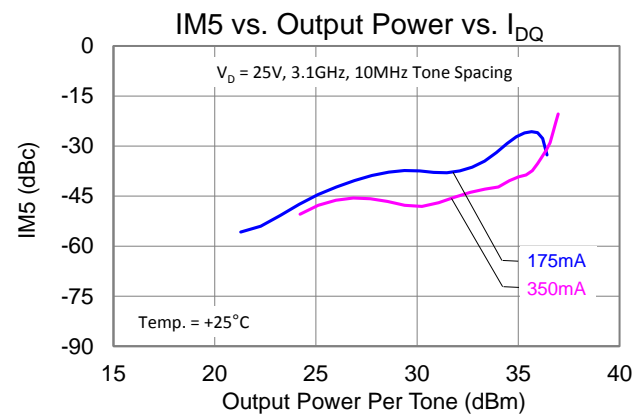
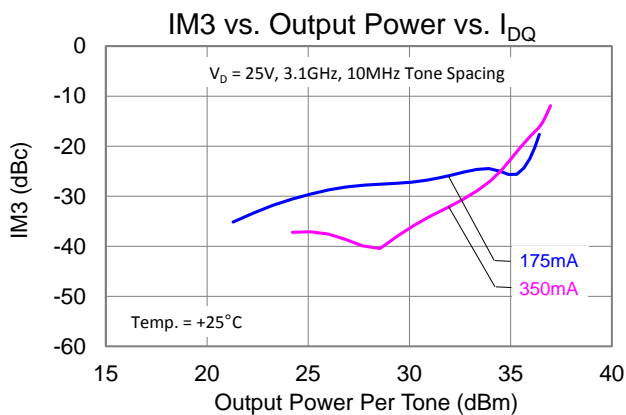
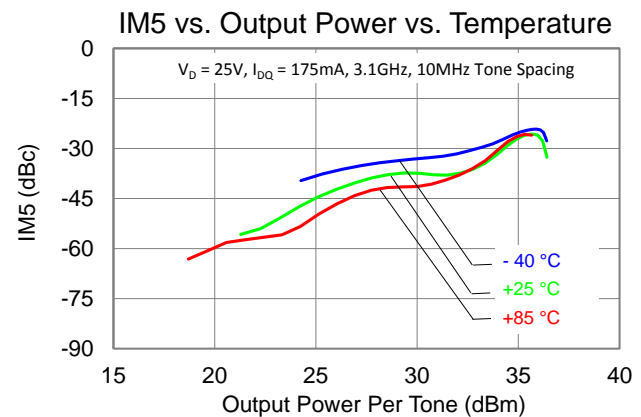
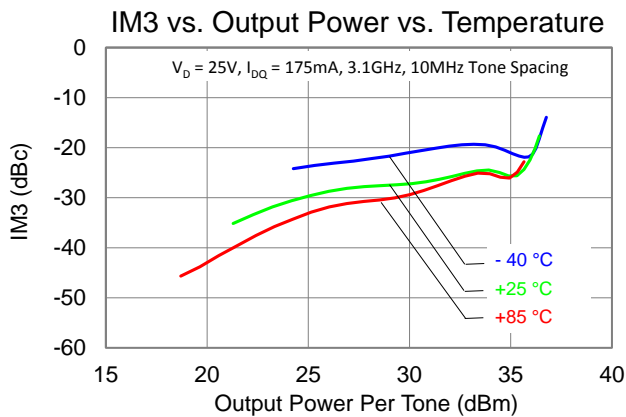
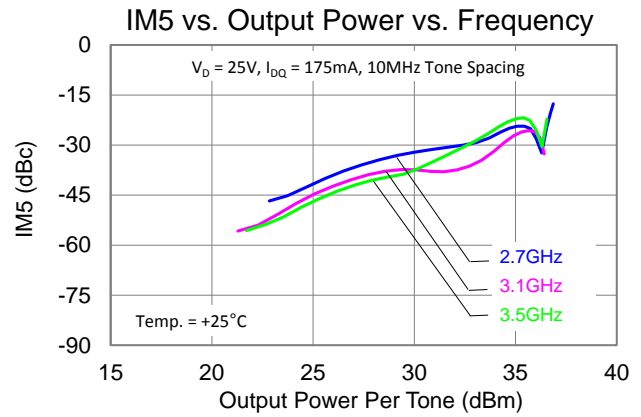
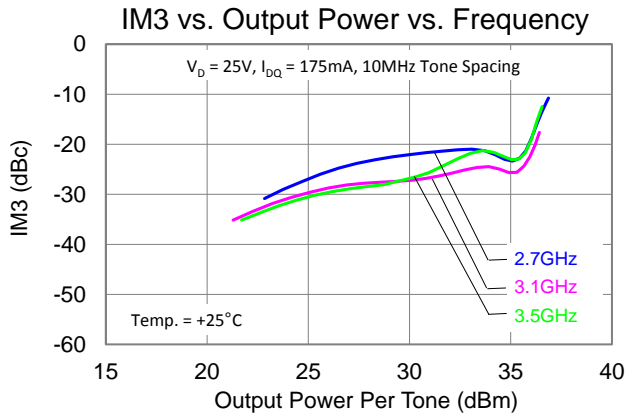

Typical Performance (Linearity)

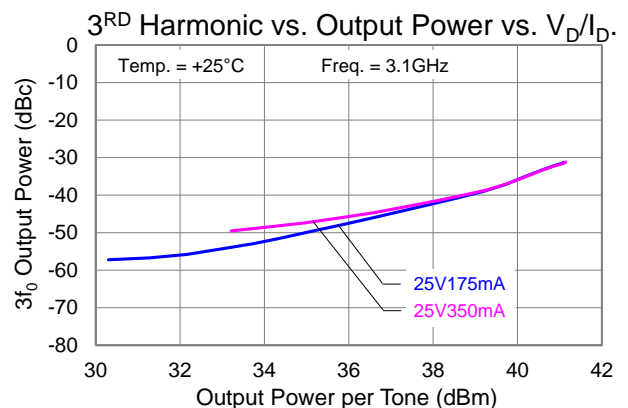
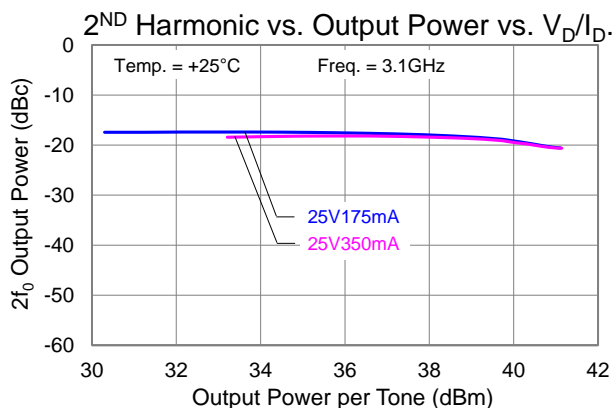
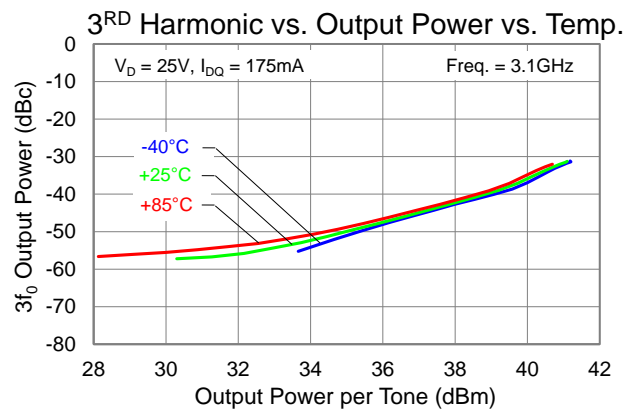
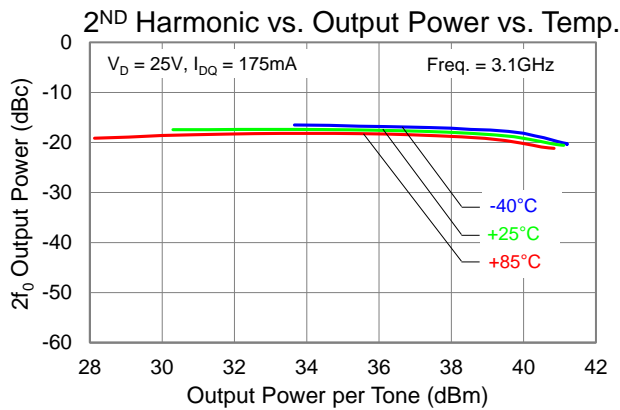
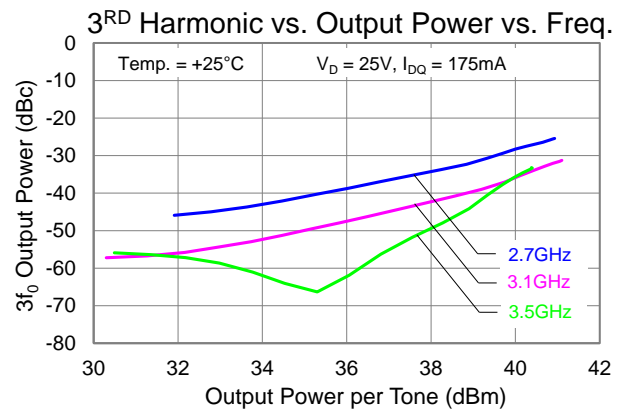
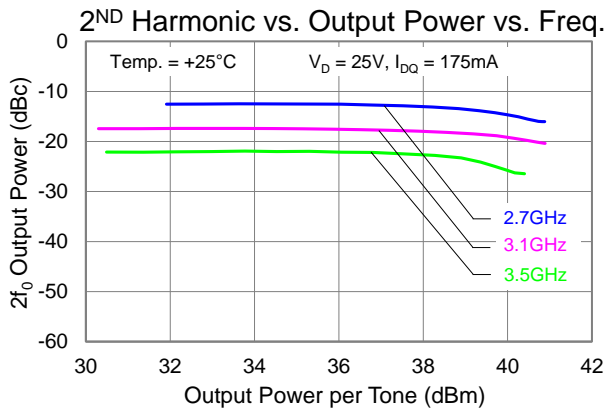

Application Circuit

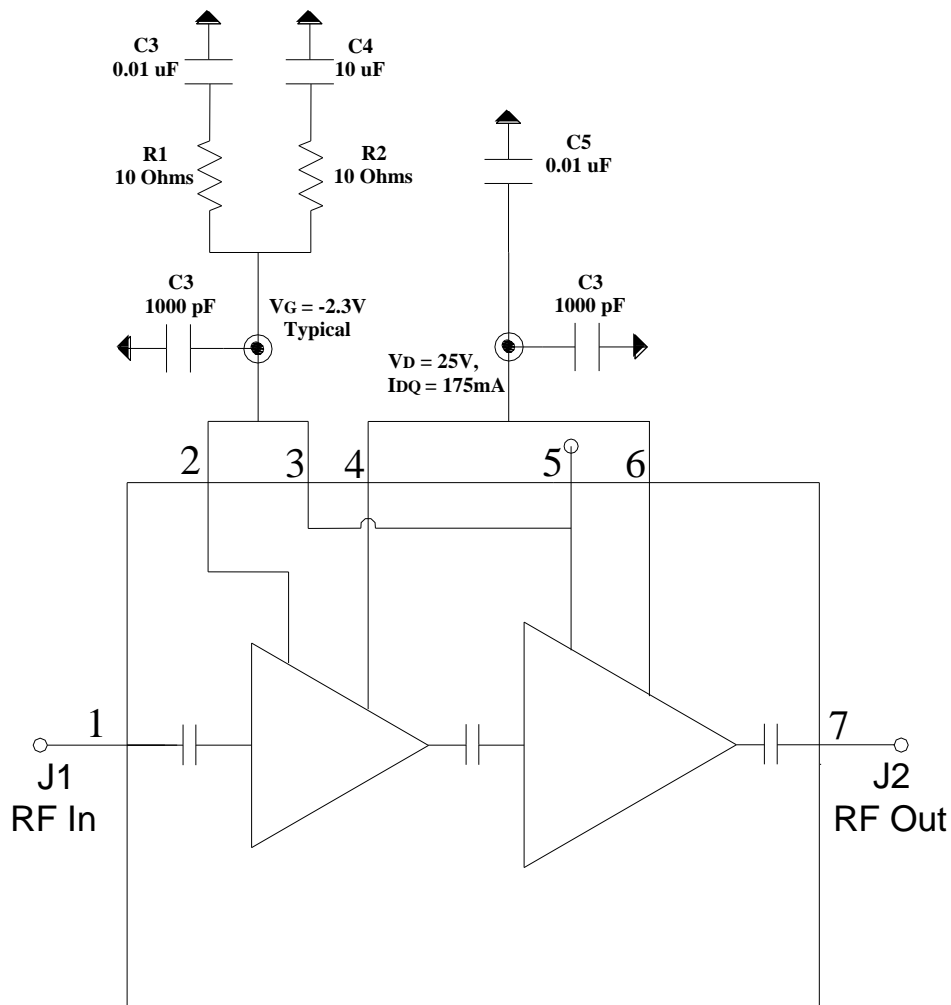

Bias-up Procedure

1. Set I_D limit to 1.2A, I_G limit to 8mA
2. Apply -5.0V to V_G
3. Apply +25V to V_D
4. Adjust V_G more positive until $I_{DQ} = 175\text{mA}$ ($V_G \sim -2.3\text{V}$ Typical)
5. Apply RF signal

Bias-down Procedure

1. Turn off RF signal
2. Reduce V_G to -5.0V. Ensure $I_{DQ} \sim 0\text{mA}$
3. Set V_D to 0V
4. Turn off V_D supply
5. Turn off V_G supply

Assembly Drawing

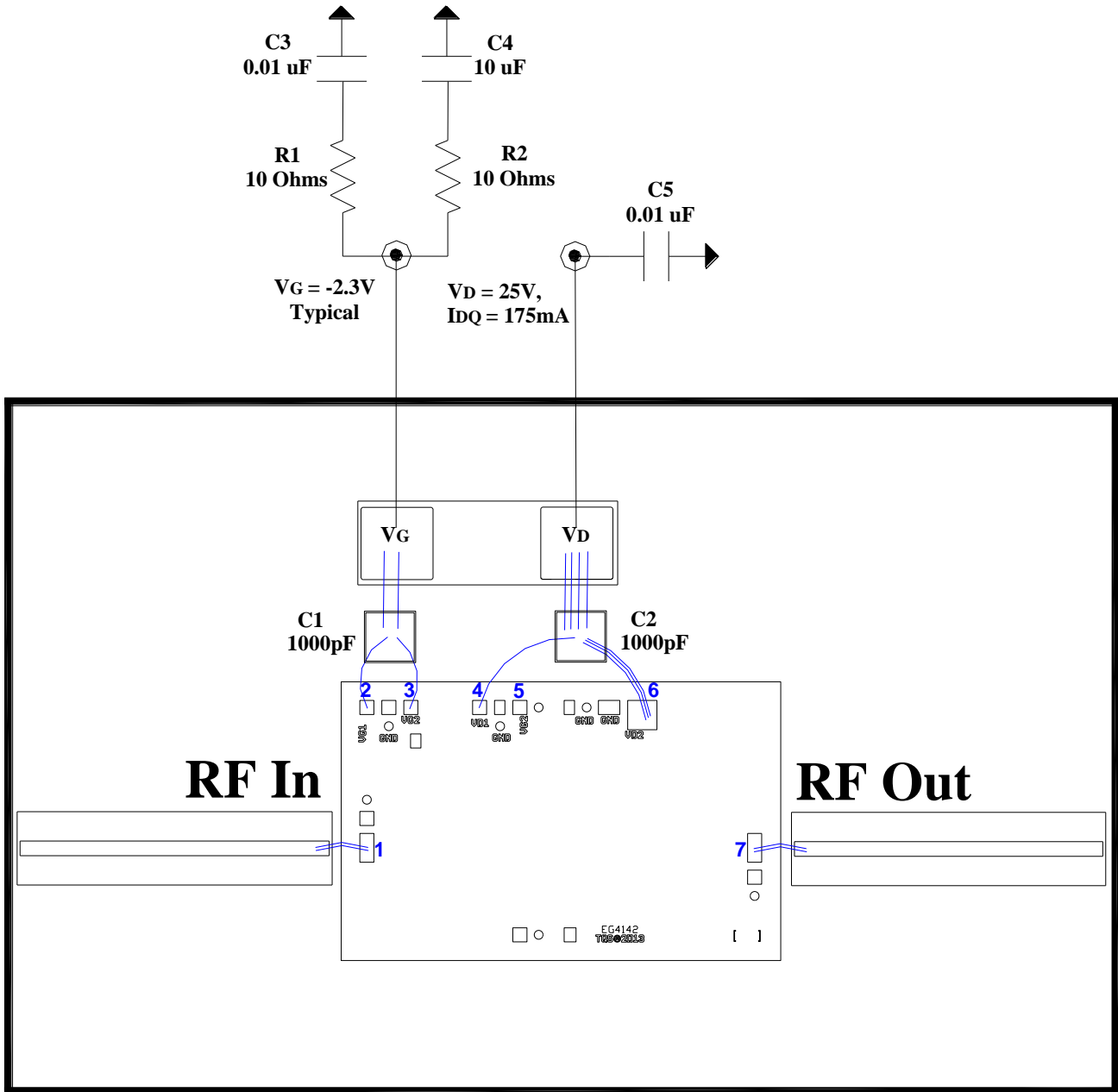

Mechanical Drawing & Bond Pad Description

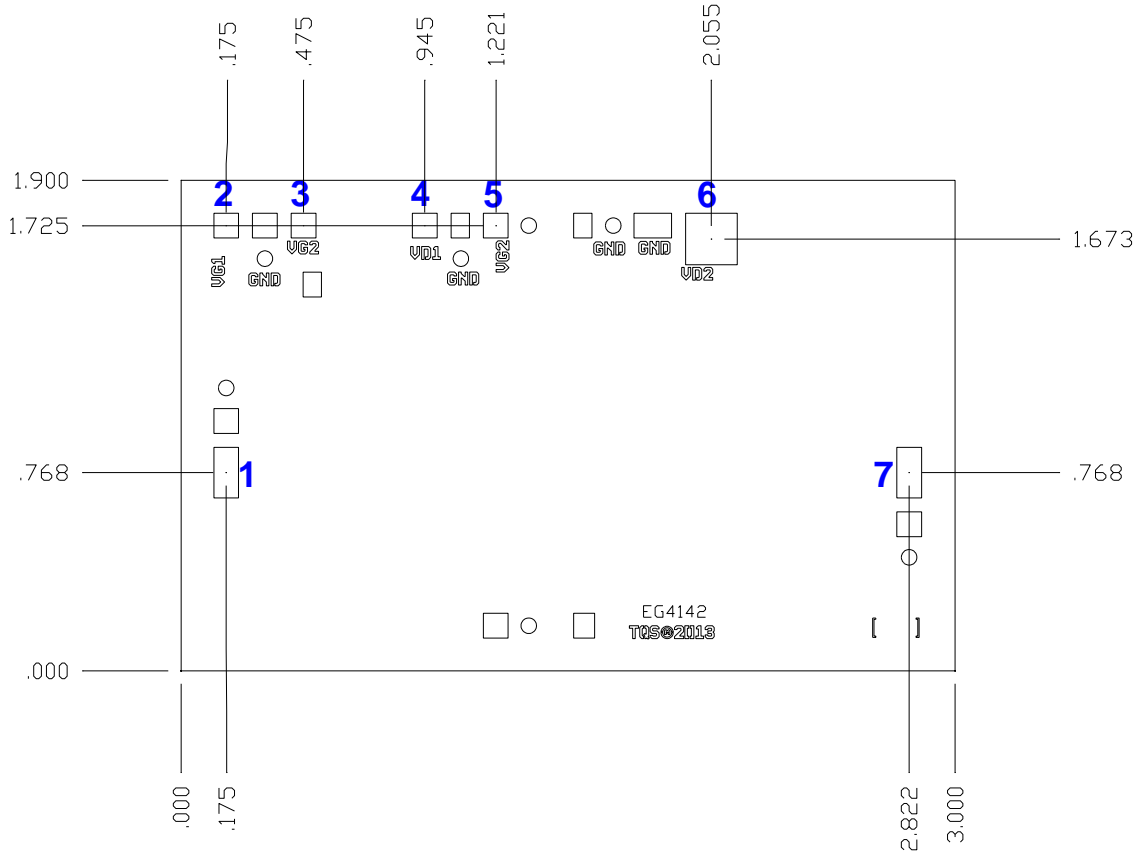

Unit: millimeters
 Thickness: 0.10
 Die x, y size tolerance: +/- 0.050
 Chip edge to bond pad dimensions are shown to center of pad
 Ground is backside of die

Bond Pad	Symbol	Pad Size	Description
1	RF In	0.096 x 0.196	Input; matched to 50 ohms; DC blocked.
2	VG1	0.096 x 0.096	Gate voltage 1, bias network is required; see Application Circuit on page 11 as an example
3, 5	VG2	0.096 x 0.096	Gate voltage 2, bias network is required; see Application Circuit on page 11 as an example. Can be biased on either pad
4	V _{D1}	0.096 x 0.096	Drain voltage 1, bias network is required; see Application Circuit on page 11 as an example.
6	V _{D2}	0.200 x 0.200	Drain voltage 2, bias network is required; see Application Circuit on page 11 as an example.
7	RF Out	0.096 x 0.196	Output; matched to 50 ohms; DC blocked.

Assembly Notes

Component placement and adhesive attachment assembly notes:

- Vacuum pencils and/or vacuum collets are the preferred method of pick up.
- Air bridges must be avoided during placement.
- The force impact is critical during auto placement.
- Organic attachment (i.e. epoxy) can be used in low-power applications.
- Curing should be done in a convection oven; proper exhaust is a safety concern.

Reflow process assembly notes:

- Use AuSn (80/20) solder and limit exposure to temperatures above 300°C to 3-4 minutes, maximum.
- An alloy station or conveyor furnace with reducing atmosphere should be used.
- Do not use any kind of flux.
- Coefficient of thermal expansion matching is critical for long-term reliability.
- Devices must be stored in a dry nitrogen atmosphere.

Interconnect process assembly notes:

- Thermosonic ball bonding is the preferred interconnect technique.
- Force, time, and ultrasonic are critical parameters.
- Aluminum wire should not be used.
- Devices with small pad sizes should be bonded with 0.0007-inch wire.

Product Compliance Information**ESD Sensitivity Ratings**

Caution! ESD-Sensitive Device

ESD Rating: TBD
Value: TBD
Test: Human Body Model (HBM)
Standard: JEDEC Standard JESD22-A114

ECCN

US Department of Commerce: 3A001.b.2.a

Solderability

This part is compliant with EU 2002/95/EC RoHS directive (Restrictions on the Use of Certain Hazardous Substances in Electrical and Electronic Equipment).

This product also has the following attributes:

- Lead Free
- Halogen Free (Chlorine, Bromine)
- Antimony Free
- TBBP-A (C₁₅H₁₂Br₄O₂) Free
- PFOS Free
- SVHC Free

Contact Information

For the latest specifications, additional product information, worldwide sales and distribution locations, and information about TriQuint:

Web: www.triquint.com
Email: info-sales@triquint.com

Tel: +1.972.994.8465
Fax: +1.972.994.8504

For technical questions and application information: Email: info-products@triquint.com

Important Notice

The information contained herein is believed to be reliable. TriQuint makes no warranties regarding the information contained herein. TriQuint assumes no responsibility or liability whatsoever for any of the information contained herein. TriQuint assumes no responsibility or liability whatsoever for the use of the information contained herein. The information contained herein is provided "AS IS, WHERE IS" and with all faults, and the entire risk associated with such information is entirely with the user. All information contained herein is subject to change without notice. Customers should obtain and verify the latest relevant information before placing orders for TriQuint products. The information contained herein or any use of such information does not grant, explicitly or implicitly, to any party any patent rights, licenses, or any other intellectual property rights, whether with regard to such information itself or anything described by such information.

TriQuint products are not warranted or authorized for use as critical components in medical, life-saving, or life-sustaining applications, or other applications where a failure would reasonably be expected to cause severe personal injury or death.

X-ON Electronics

Largest Supplier of Electrical and Electronic Components

Click to view similar products for [RF Amplifier](#) category:

Click to view products by [Qorvo](#) manufacturer:

Other Similar products are found below :

[A82-1](#) [BGA622H6820XTSA1](#) [BGA 728L7 E6327](#) [BGB719N7ESDE6327XTMA1](#) [HMC397-SX](#) [HMC405](#) [HMC561-SX](#) [HMC8120-SX](#)
[HMC8121-SX](#) [HMC-ALH382-SX](#) [HMC-ALH476-SX](#) [SE2433T-R](#) [SMA3101-TL-E](#) [SMA39](#) [A66-1](#) [A66-3](#) [A67-1](#) [LX5535LQ](#) [LX5540LL](#)
[MAAM02350](#) [HMC3653LP3BETR](#) [HMC549MS8GETR](#) [HMC-ALH435-SX](#) [SMA101](#) [SMA32](#) [SMA411](#) [SMA531](#) [SST12LP19E-QX6E](#)
[WPM0510A](#) [HMC5929LS6TR](#) [HMC5879LS7TR](#) [HMC1126](#) [HMC1087F10](#) [HMC1086](#) [HMC1016](#) [SMA1212](#) [MAX2689EWS+T](#)
[MAAMSS0041TR](#) [MAAM37000-A1G](#) [LTC6430AIUF-15#PBF](#) [SMA70-2](#) [SMA4011](#) [A231](#) [HMC-AUH232](#) [LX5511LQ](#) [LX5511LQ-TR](#)
[HMC7441-SX](#) [HMC-ALH310](#) [XD1001-BD-000V](#) [A4011](#)