

Product Description

Qorvo's TGA2594-HM is a packaged power amplifier fabricated on Qorvo's 0.15um GaN on SiC process (QGaN15). Operating from 27 to 31 GHz, the TGA2594-HM achieves 36.3dBm saturated output power with a power-added efficiency of 25%, and 25dB small signal gain.

The TGA2594-HM is offered in a hermetically sealed 22-lead 7x7 mm ceramic QFN designed for surface mount to a printed circuit board. The package has a Cu base, offering superior thermal management. The TGA2594-HM is ideally suited to support both commercial and military applications.

Both RF ports have integrated DC blocking capacitors and are fully matched to 50 Ohms.

Lead free and RoHS compliant.

Functional Block Diagram

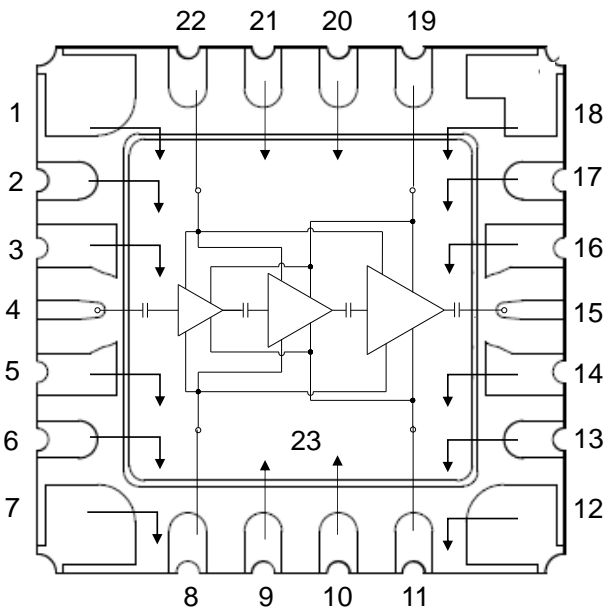

Top View

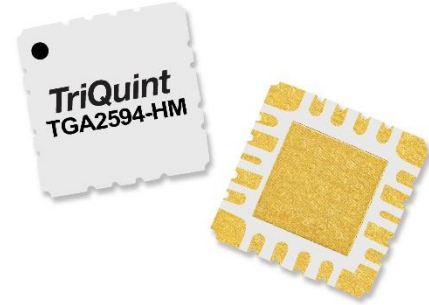

Product Features

- Frequency Range: 27 – 31 GHz
- P_{OUT}: 36.3 dBm (P_{IN} = 17 dBm)
- PAE: 25 % CW (P_{IN} = 17 dBm)
- Small Signal Gain: 25 dB
- IM3: -35 dBc @ 25 dBm P_{OUT} / Tone
- Bias: V_D = +20 V, I_{DQ} = 140 mA
- Package Dimensions: 7.0 x 7.0 x 1.3 mm

Applications

- Military SATCOM Terminals
- Commercial SATCOM Terminals
- Point-to-Point Digital Radio
- Point-to Multipoint Digital Radio

Ordering Information

Part No.	Description
TGA2594-HM	27 – 31 GHz GaN Power Amplifier
TGA2594-HMEVBP01	Evaluation Board



TGA2594-HM

27 – 31 GHz GaN Power Amplifier

Absolute Maximum Ratings

Parameter	Value / Range
Drain Voltage (V_D)	+29.5 V
Gate Voltage Range (V_G)	-4 to 0 V
Drain Current (I_D)	1.4 A
Gate Current (I_G), 85 °C	See plot pg. 3
Power Dissipation (P_{DISS}), 85 °C	15 W
Input Power, CW, 50 Ω , (P_{IN})	30 dBm
Mounting Temperature (30 Seconds)	260 °C
Storage Temperature	-55 to 150 °C

Operation of this device outside the parameter ranges given above may cause permanent damage. These are stress ratings only, and functional operation of the device at these conditions is not implied.

Recommended Operating

Parameter	Value / Range
Drain Voltage (V_D)	+20 V
Drain Current (I_{DQ})	140 mA
Gate Voltage (V_G)	-3.0 to -2.0 V
Drain Current Under RF Drive (I_{D_DRIVE})	See plots pg. 7
Gate Current Under RF Drive (I_{G_DRIVE})	See plots pg. 7
Temperature (T_{BASE})	-40 to 85 °C

Electrical specifications are measured at specified test conditions. Specifications are not guaranteed over all recommended operating conditions.

Electrical Specifications

Parameter	Min	Typ	Max	Units
Operational Frequency Range	27	-	31	GHz
Small Signal Gain	-	25	-	dB
Input Return Loss	-	> 5	-	dB
Output Return Loss	-	> 5	-	dB
Output Power ($P_{IN} = 17$ dBm)	-	36.3	-	dBm
Power Added Efficiency ($P_{IN} = 17$ dBm)	-	25	-	%
IM3 ($P_{OUT}/\text{Tone} = 25$ dBm/Tone)	-	-35	-	dBc
IM5 ($P_{OUT}/\text{Tone} = 25$ dBm/Tone)	-	-43	-	dBc
Gate Leakage Current ($V_D = 10$ V, $V_G = -3.7$ V)	-3.1			mA
Small Signal Gain Temperature Coefficient	-	-0.05	-	dB/°C
Output Power Temperature Coefficient	-	-0.04	-	dBm/°C

Test conditions unless otherwise noted: 25 °C, $V_D = +20$ V, $I_{DQ} = 140$ mA, CW

Thermal and Reliability Information

Parameter	Test Conditions	Value	Units
Thermal Resistance (θ_{JC}) ⁽¹⁾	$T_{BASE}=85\text{ }^{\circ}\text{C}$, $V_D=20\text{ V}$, $I_{DQ}=140\text{ mA}$, $Freq=27.7\text{ GHz}$, $P_{IN}=17\text{ dBm}$, $I_{D_Drive}=783\text{ mA}$,	8.05	$^{\circ}\text{C/W}$
Channel Temperature (T_{CH}) ⁽²⁾ (w/RF drive)	$P_{OUT} = 35.3\text{ dBm}$, $P_{DISS} = 12.3\text{ W}$	184	$^{\circ}\text{C}$

Notes:

1. Thermal resistance measured to back of package.
2. IR Scan Equivalent. Refer to the following document: [GaN Device Channel Temperature, Thermal Resistance, and Reliability Estimates](#)

Power Dissipation and Maximum Gate Current

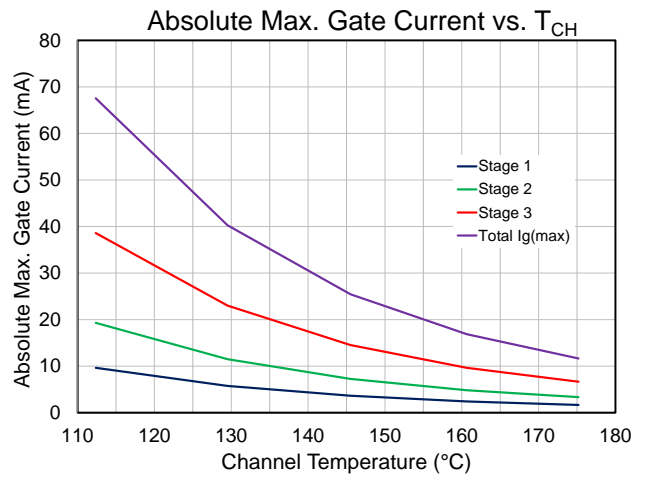
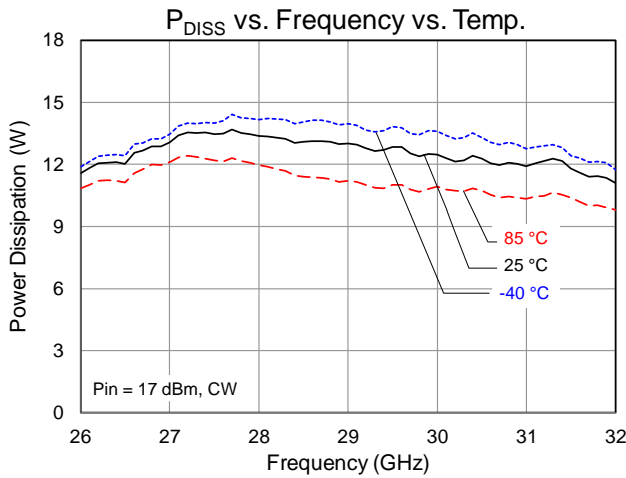

Performance Plots – Small Signal

Conditions unless otherwise specified: $V_D = +20\text{ V}$, $I_{DQ} = 140\text{ mA}$, CW

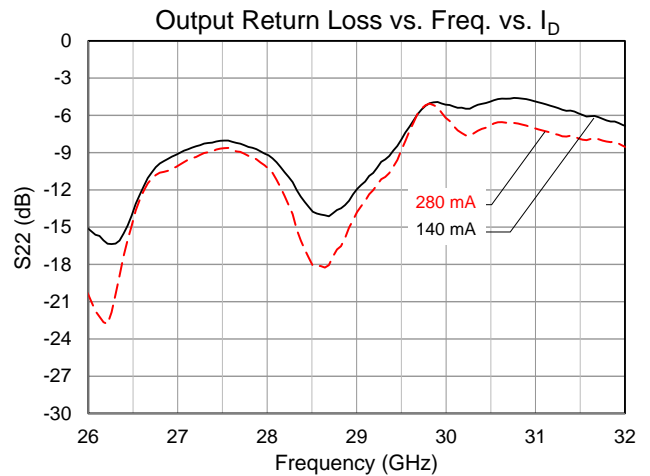
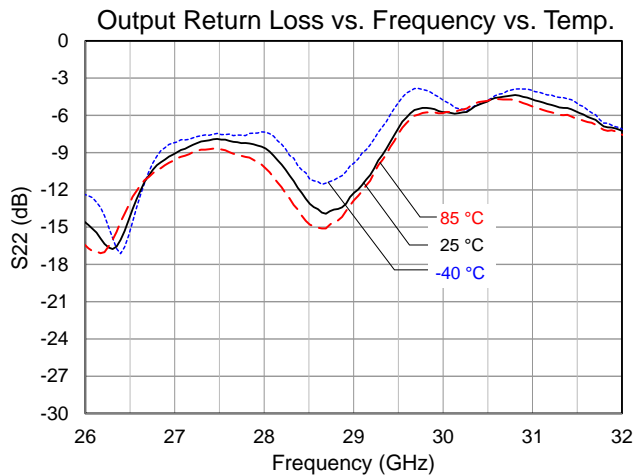
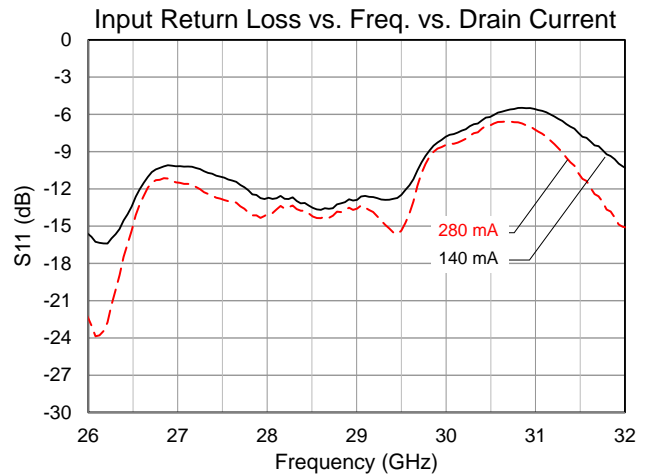
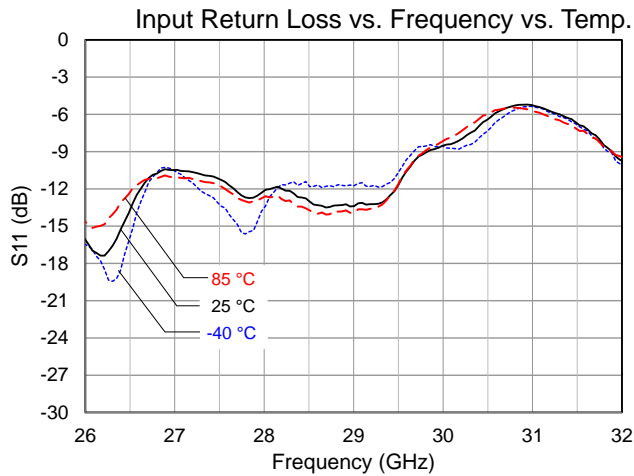
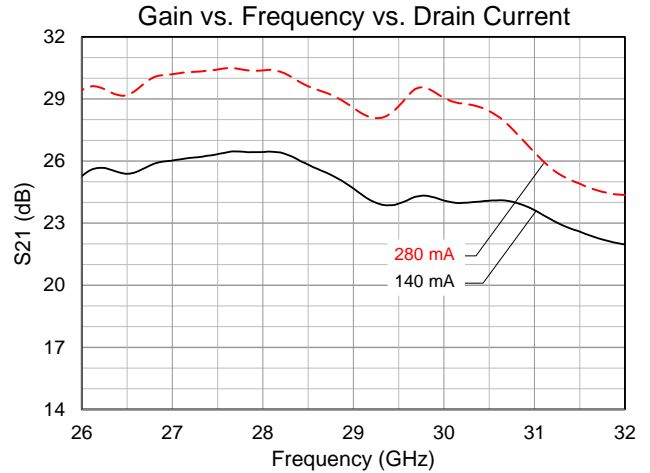
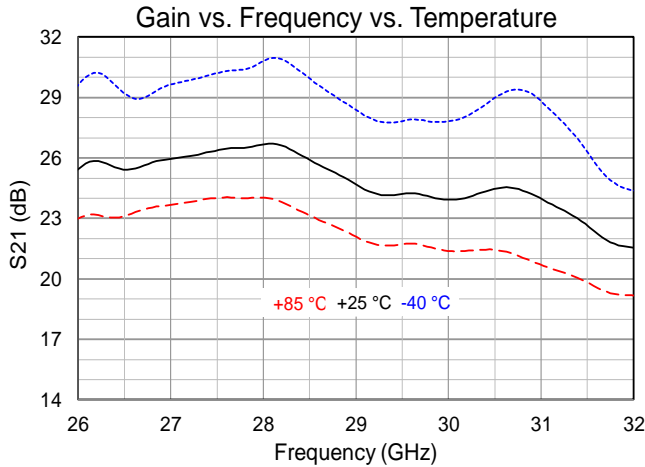

Performance Plots – Large Signal

Conditions unless otherwise specified: $V_D = +20\text{ V}$, $I_{DQ} = 140\text{ mA}$, CW

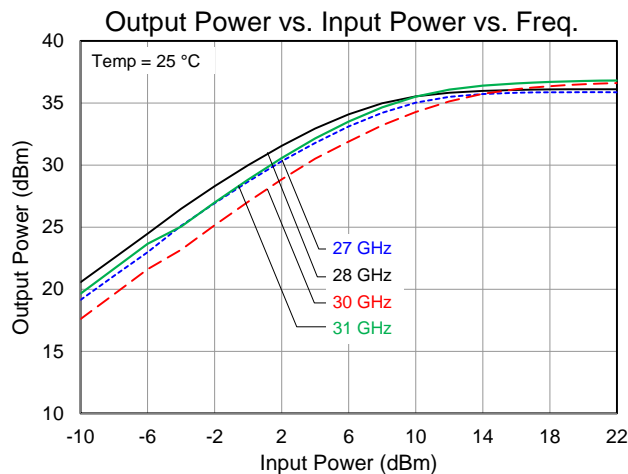
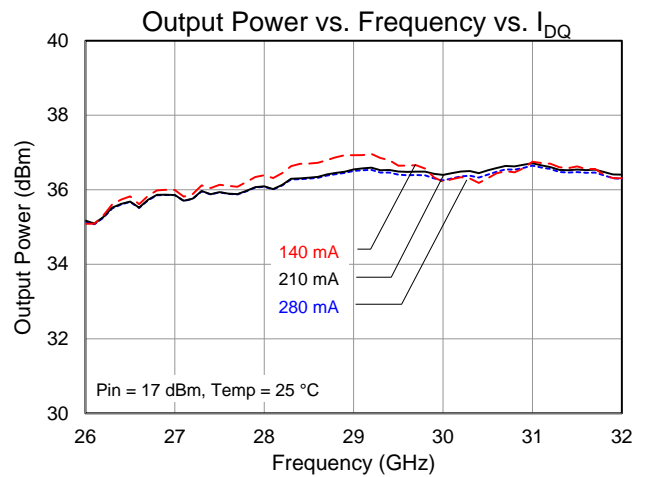
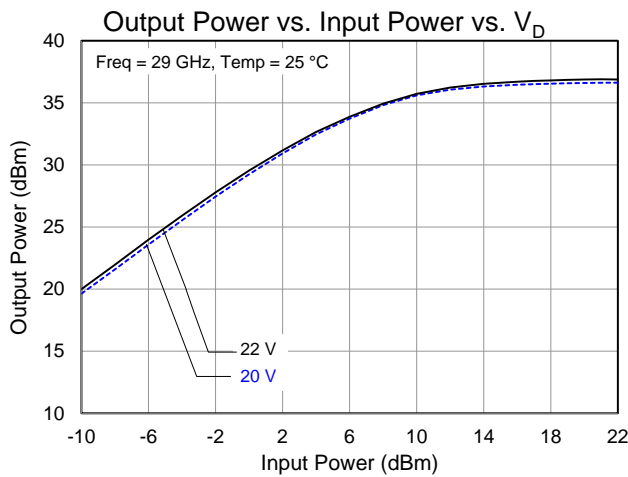
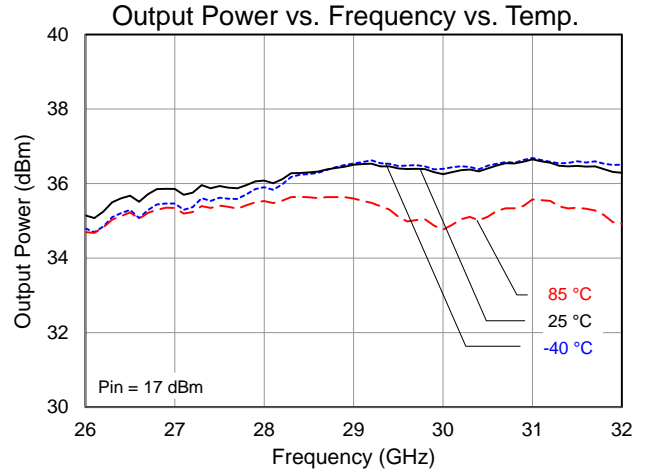
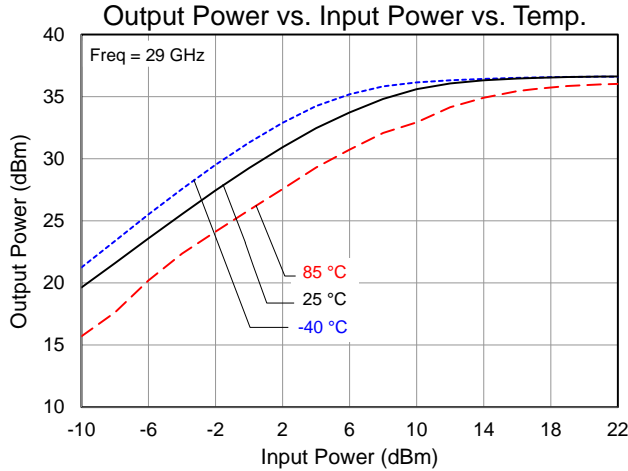

Performance Plots – Large Signal

Conditions unless otherwise specified: $V_D = +20\text{ V}$, $I_{DQ} = 140\text{ mA}$, CW

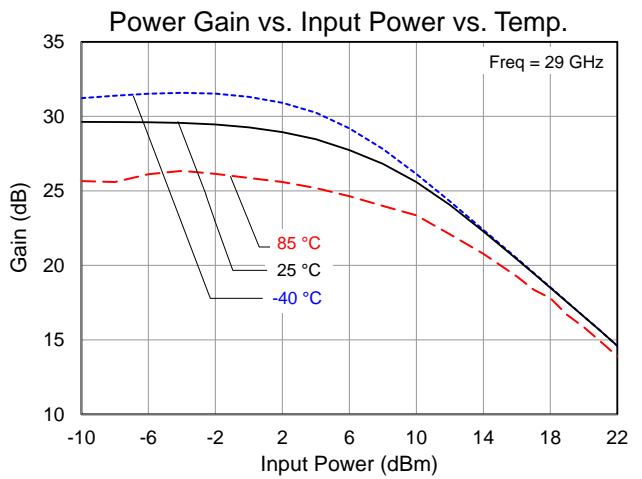
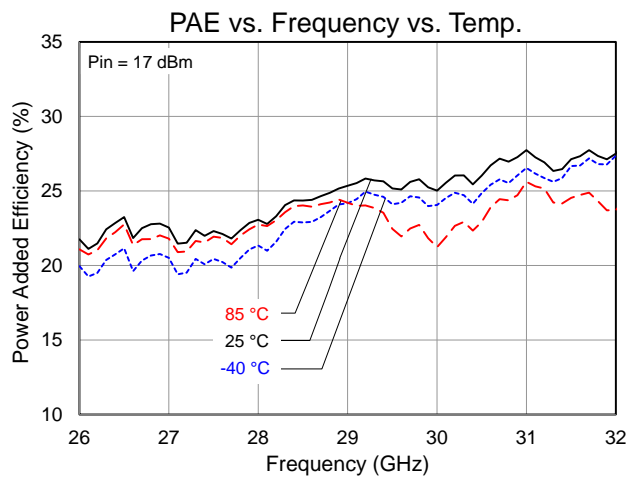
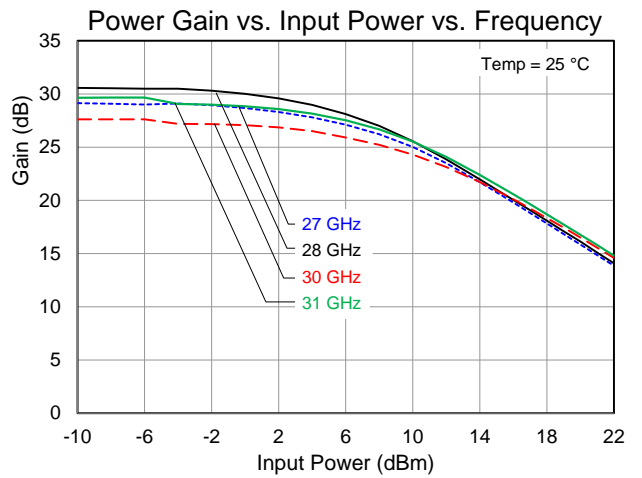
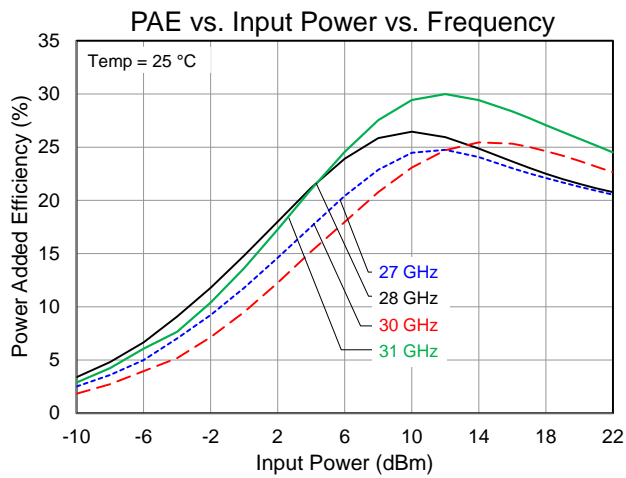
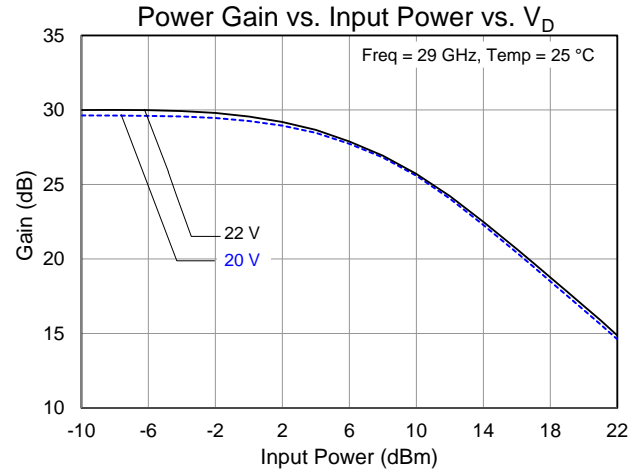
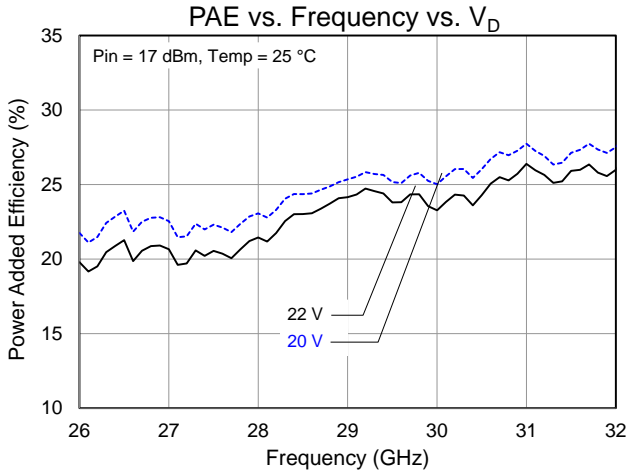

Performance Plots – Large Signal

Conditions unless otherwise specified: $V_D = +20\text{ V}$, $I_{DQ} = 140\text{ mA}$, CW

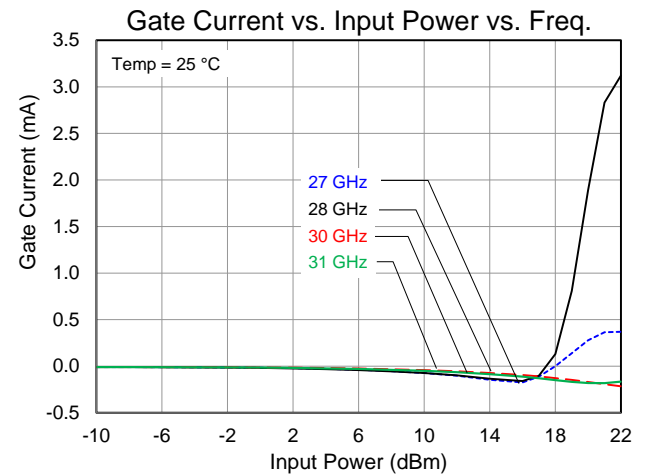
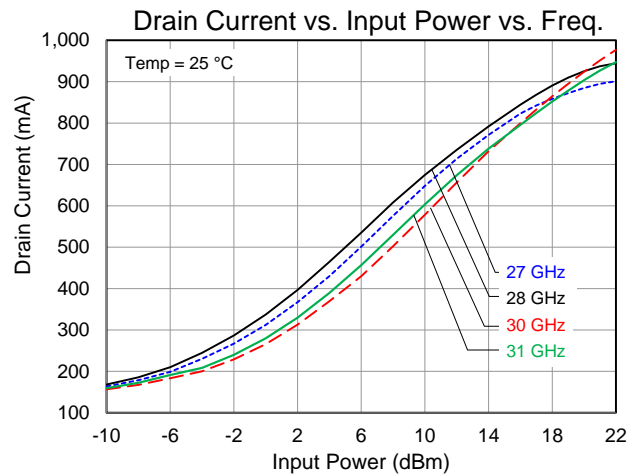
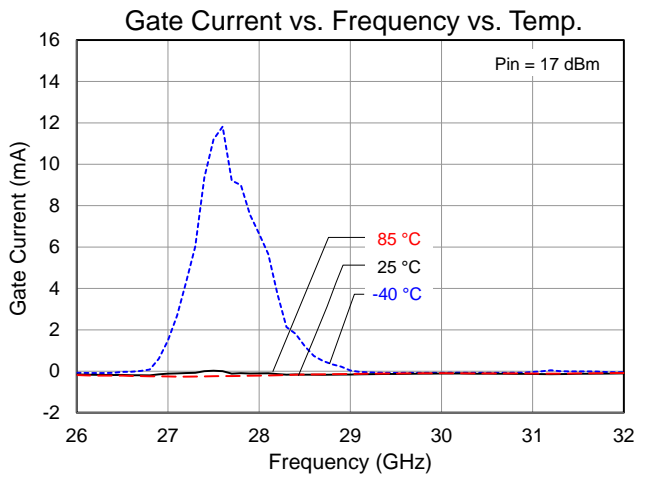
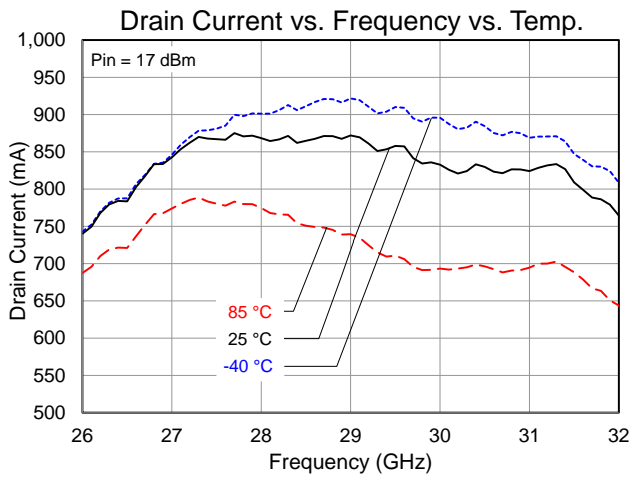
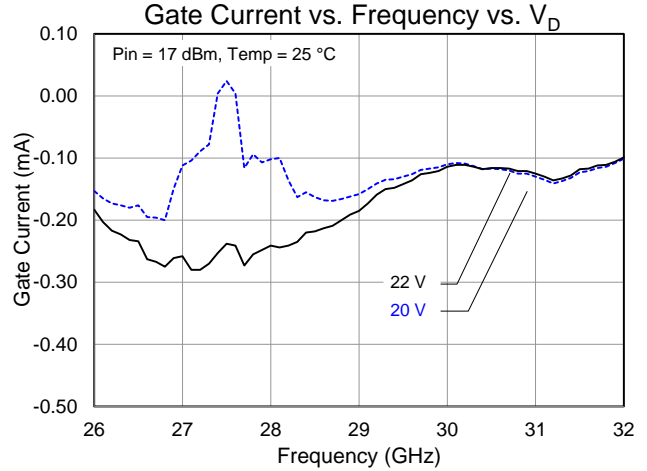
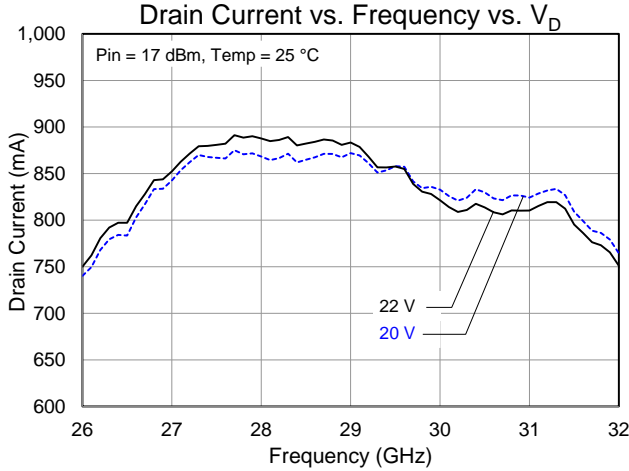

Performance Plots – Large Signal and Linearity

Conditions unless otherwise specified: $V_D = +20\text{ V}$, $I_{DQ} = 140\text{ mA}$, CW

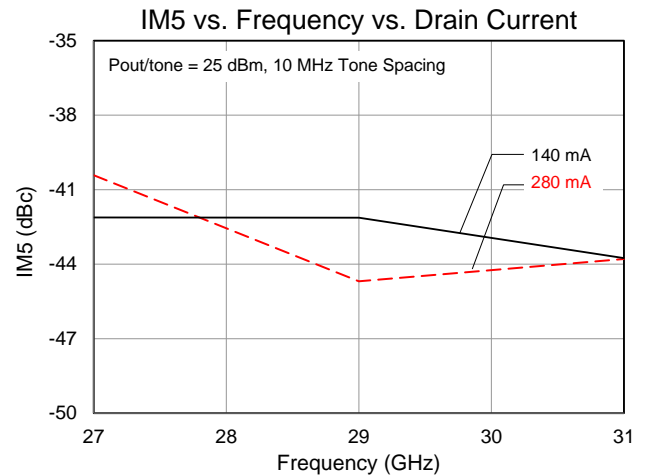
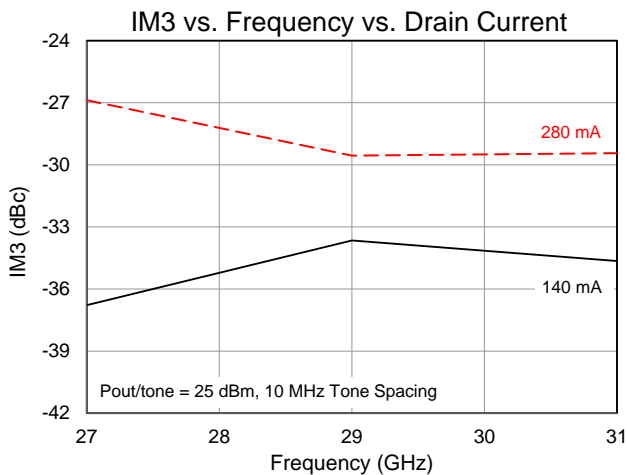
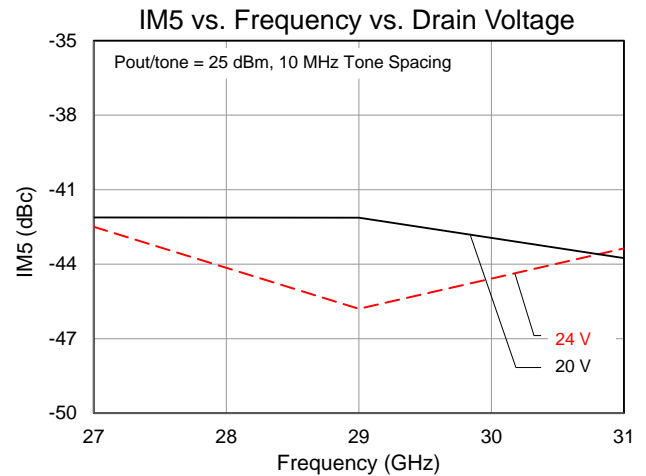
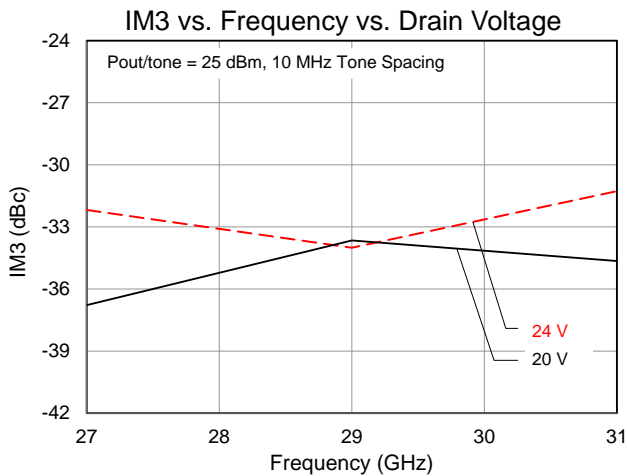
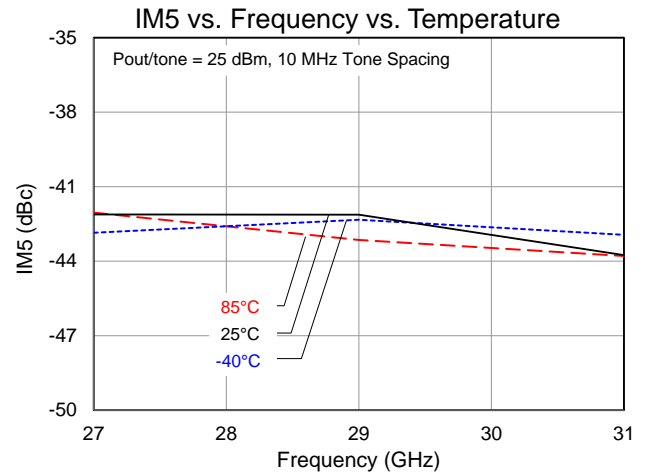
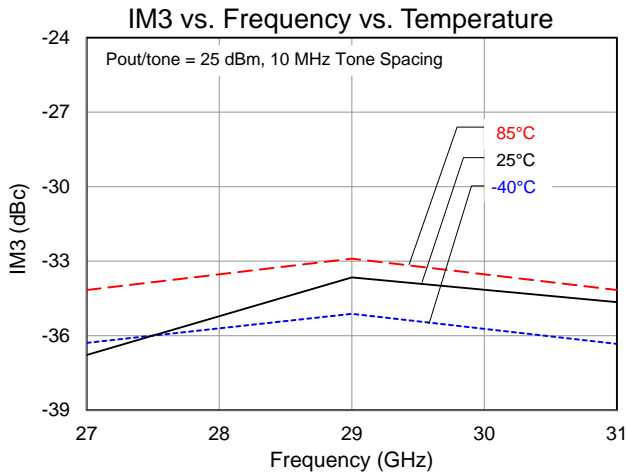

Applications Information and Pad Layout

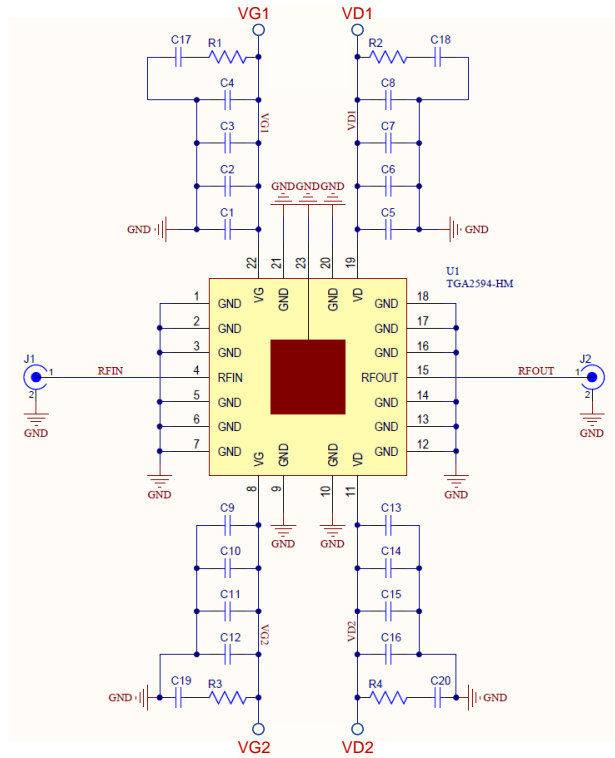

Bias Up Procedure

1. Set I_D limit to 1.2 A, I_G limit to 10 mA
2. Apply -4 V to V_G
3. Apply $+20\text{ V}$ to V_D ; ensure I_{DQ} is approx. 0 mA
4. Adjust V_G until $I_{DQ} = 140\text{ mA}$
5. Turn on RF supply

Bias Down Procedure

1. Turn off RF supply
2. Reduce V_G to -4 V ; ensure I_{DQ} is approx. 0 mA
3. Set V_D to 0 V
4. Turn off V_D supply
5. Turn off V_G supply

Pad Description

Pad No.	Symbol	Description
1-3, 5-7, 9,10,12-14, 16-18, 20,21,23	GND	Must be grounded on the PCB.
4	RF _{IN}	Output; matched to 50 Ω; DC blocked
8, 11	NC	For use with Qorvo EVB, do not connect (pins are connected internal to package)
15	RF _{OUT}	Input; matched to 50 Ω; DC blocked
19	V _D (1)	Drain voltage; Bias network is required; see recommended Application Information above.
22	V _G (2)	Gate Voltage; Bias network is required; see recommended Application Information above.

Notes:

1. If not using TQ EVB, VD may be applied to either pin 11 or pin 19.
2. If not using TQ EVB, VG may be applied to either pin 8 or pin 22.

Evaluation Board

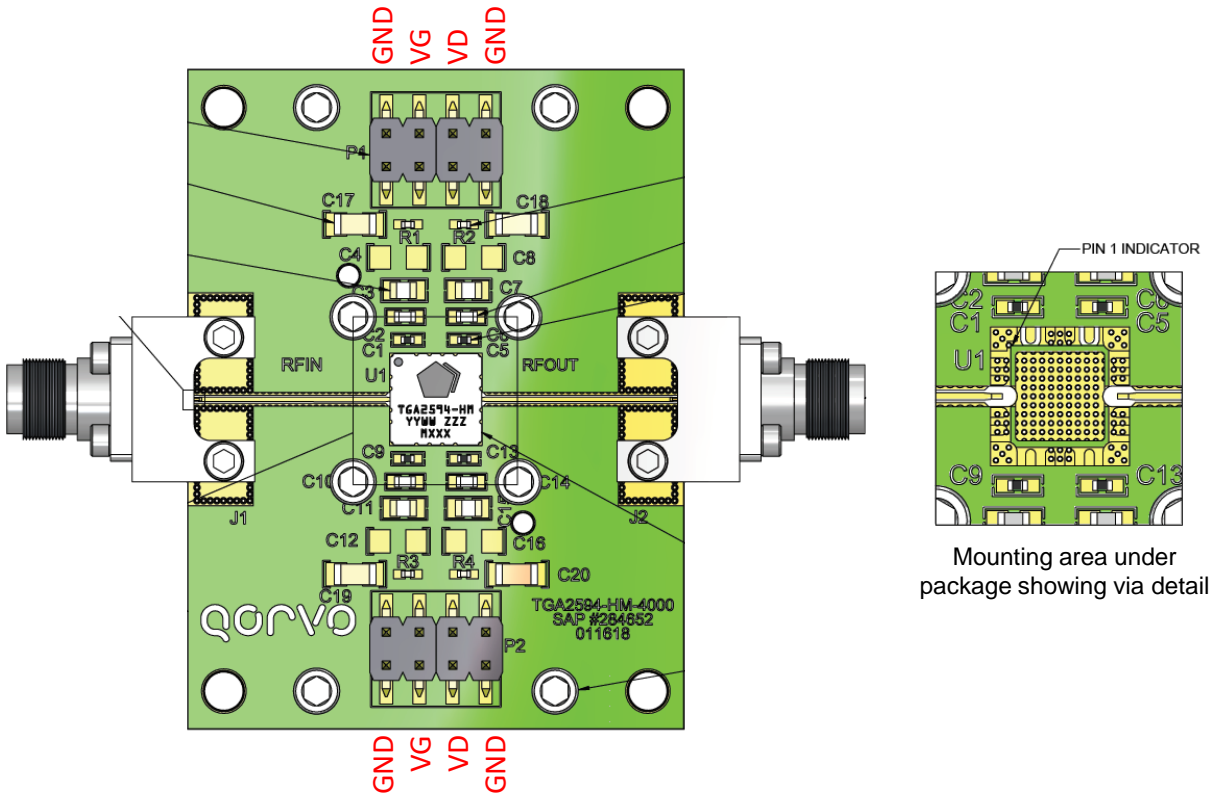

Bill of Materials

Reference Des.	Value	Description	Manuf.	Part Number
C1, C5, C9, C13	1000 pF	CAP, 1000pF, 10%, 50V, X7R, 0402	Various	–
C2, C6, C10, C14	0.1 μ F	CAP, 0.1uF, 10%, 50V, X7R, 0603	Various	–
C3, C7, C11, C15	1 μ F	CAP, 1uF, 10%, 50V, X7R, 0805	Various	–
C17, C18, C19, C20	10 μ F	CAP, 10uF, 20%, 50V, 20%, X5R, 1206	Various	–
R1, R2, R3, R4	10 Ohm	RES, 10 OHM, 5%, 0.1W, 0402	Various	–
C4, C8, C12, C16	Not Used	Not Used	N/A	–
J1, J2	2.92 mm	RF End Launch Female Connectors	Southwest Microwave	1092-01A-5

Note: Locations for capacitors C4, C8, C12, C16 are available if additional bypassing is needed.

Evaluation Board - PCB Layout Detail

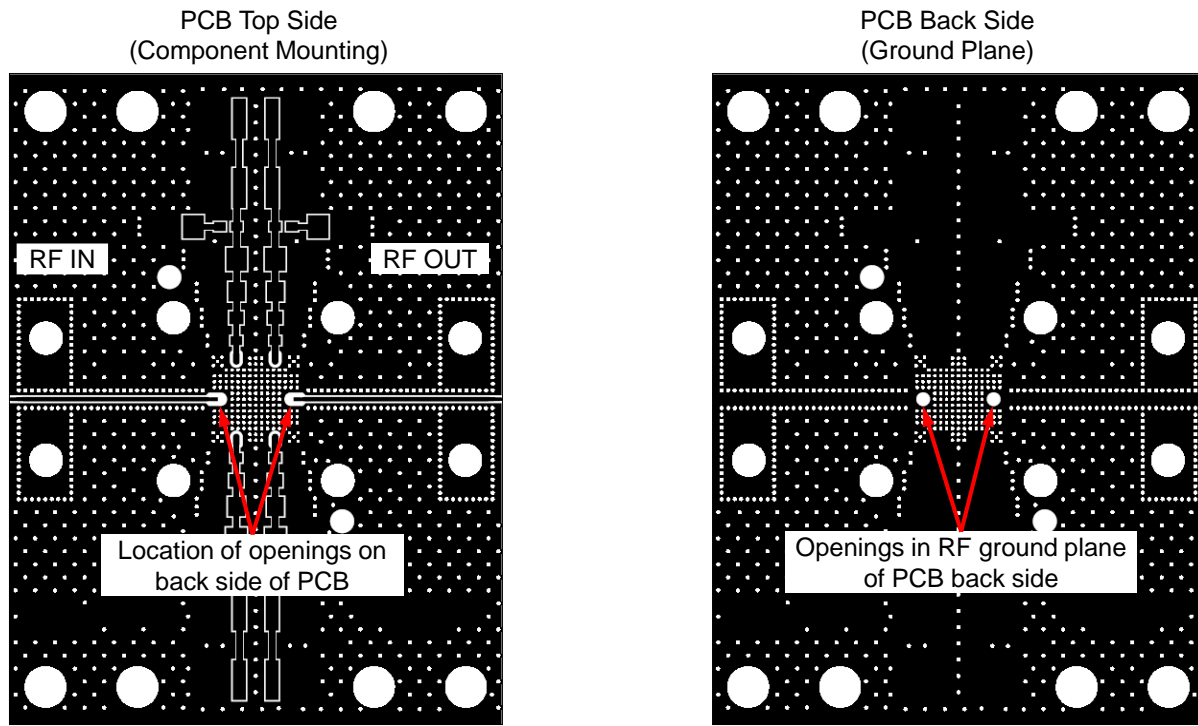

Notes:

1. Existence of 1 mm diameter opening on backside of EVB – the openings are required for all EVBs.
2. See Assembly Notes (page 11) for additional detail.
3. Machine two recess holes in carrier/heat sink under PCB in location of ground plane openings shown above.
Dimensions: 0.079 diameter, 0.158 deep

Assembly Notes

1. Clean the board or module with alcohol. Allow it to dry fully.
2. Apply solder paste to each pin of the TGA2594-HM, and heat to achieve reflow, being careful not to exceed the thermal budget.
3. Clean the assembly with alcohol.
4. To obtain quoted RF performance, the following is required:
 - i. On the printed circuit board, there must be two 1 mm (0.0394") diameter openings on the backside (RF Ground Plane) of the circuit board.
 - Location of the openings is contained in the PCB layout.
 - The 1 mm (0.0394") diameter openings for the board are shown in the diagram below in reference to the base of the package, and shown on the PCB layout on page 11.
 - ii. Use of a carrier plate with 2 mm (0.0787") diameter holes (these are for tuning the RF input and output match of the package).
 - The holes should be located with respect to the package pin-out as shown in the diagram below.
 - The holes should be 4 mm (0.1575") deep.
5. To improve thermal performance, the following is recommended:
 - i. Use of a 4 mil indium shim between the circuit board and the carrier plate.
 - ii. The indium shim should have the same hole diameters and positioning as the carrier plate (see diagram below for location with respect to the package backside). The holes should be machined fully through the indium shim.

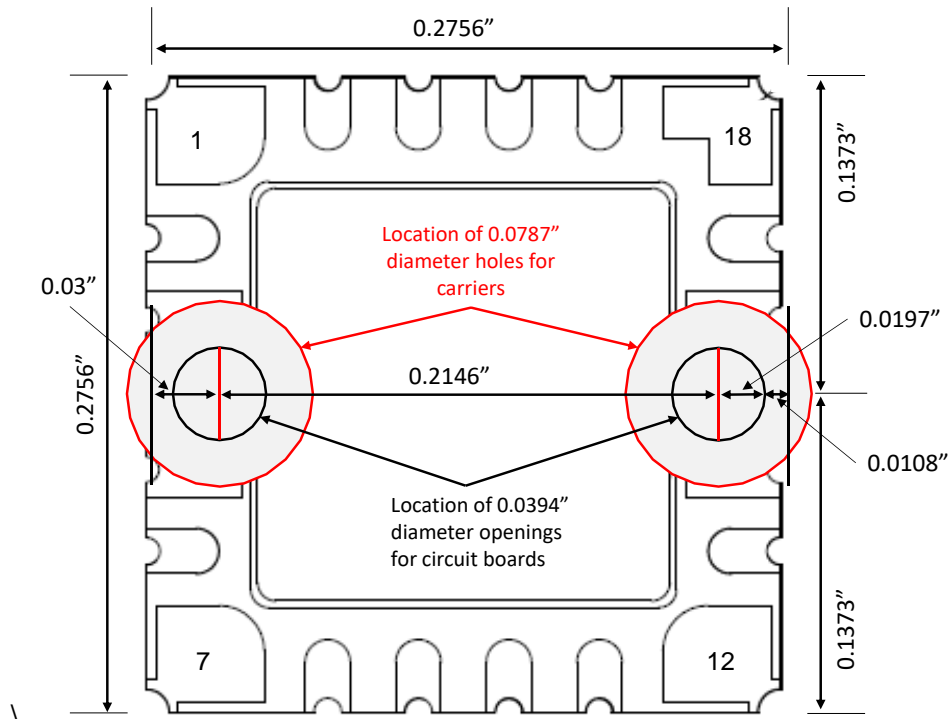

Top View (through package to PCB/carrier)

Assembly Notes (continued)

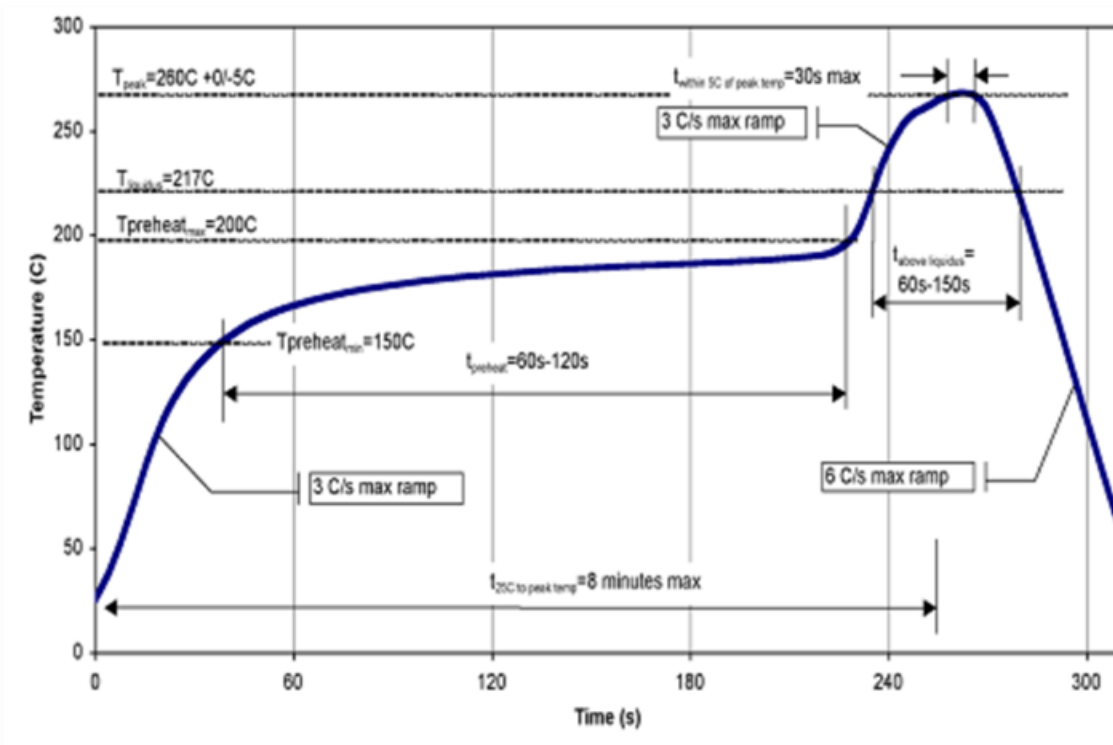

Recommended Solder Profile

Mechanical Information

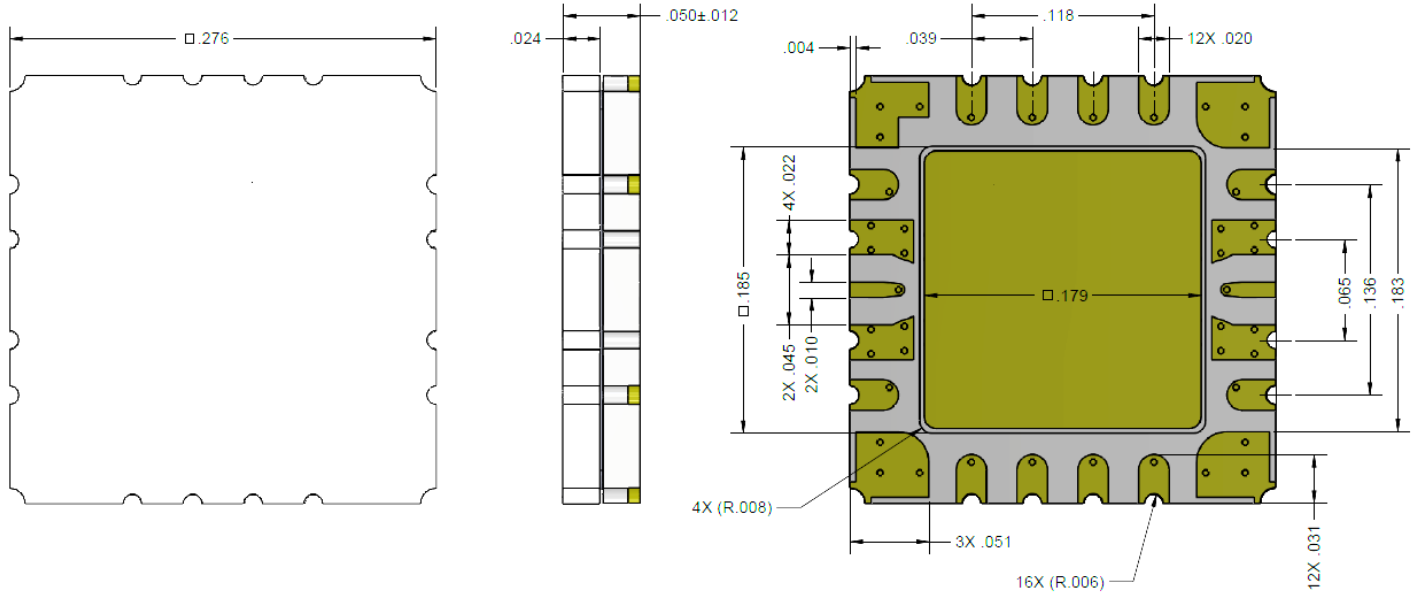
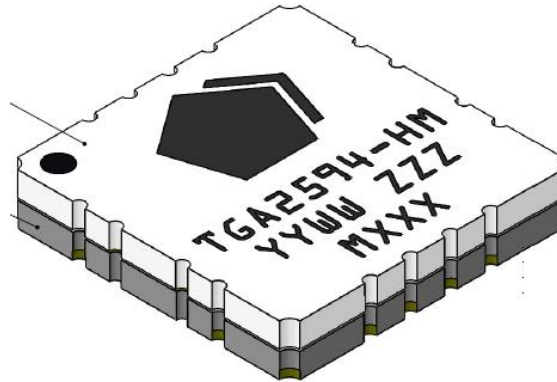

Units: inches

Tolerances: unless specified

x.xx = ± 0.01

x.xxx = ± 0.006

Materials:

Package: Metal/Ceramic

Lid: Ceramic

All metalized features are gold plated

Part is solder sealed

Marking:

2594: Part number

YY: Part Assembly year

WW: Part Assembly week

ZZZ: Serial Number

MXXX: Batch ID

Handling Precautions

Parameter	Rating	Standard
ESD – Human Body Model (HBM)	Class 1A, 400 V	JEDEC Standard JESD22 A114
MSL – Convection Reflow	N/A, Hermetic Package	JEDEC standard IPC/JEDEC J-STD-020.



Caution!
ESD-Sensitive Device

Solderability

Compatible with the latest version of J-STD-020, Lead-free solder, 260 °C

RoHS Compliance

This product is compliant with the 2011/65/EU RoHS directive (Restrictions on the Use of Certain Hazardous Substances in Electrical and Electronic Equipment), as amended by Directive 2015/863/EU. This product also has the following attributes:

- Lead Free
- Halogen Free (Chlorine, Bromine)
- Antimony Free
- TBBP-A (C₁₅H₁₂Br₄O₂) Free
- SVHC Free

Contact Information

For the latest specifications, additional product information, worldwide sales and distribution locations:

Web: www.qorvo.com

Tel: 1-844-890-8163

Email: customer.support@qorvo.com

Important Notice

The information contained herein is believed to be reliable; however, Qorvo makes no warranties regarding the information contained herein and assumes no responsibility or liability whatsoever for the use of the information contained herein. All information contained herein is subject to change without notice. Customers should obtain and verify the latest relevant information before placing orders for Qorvo products. The information contained herein or any use of such information does not grant, explicitly or implicitly, to any party any patent rights, licenses, or any other intellectual property rights, whether with regard to such information itself or anything described by such information. **THIS INFORMATION DOES NOT CONSTITUTE A WARRANTY WITH RESPECT TO THE PRODUCTS DESCRIBED HEREIN, AND QORVO HEREBY DISCLAIMS ANY AND ALL WARRANTIES WITH RESPECT TO SUCH PRODUCTS WHETHER EXPRESS OR IMPLIED BY LAW, COURSE OF DEALING, COURSE OF PERFORMANCE, USAGE OF TRADE OR OTHERWISE, INCLUDING THE IMPLIED WARRANTIES OF MERCHANTABILITY AND FITNESS FOR A PARTICULAR PURPOSE.**

Without limiting the generality of the foregoing, Qorvo products are not warranted or authorized for use as critical components in medical, life-saving, or life-sustaining applications, or other applications where a failure would reasonably be expected to cause severe personal injury or death.

© 2021 Qorvo US, Inc. All rights reserved. This document is subject to copyright laws in various jurisdictions worldwide and may not be reproduced or distributed, in whole or in part, without the express written consent of Qorvo US, Inc.

X-ON Electronics

Largest Supplier of Electrical and Electronic Components

Click to view similar products for [RF Amplifier](#) category:

Click to view products by [Qorvo](#) manufacturer:

Other Similar products are found below :

[A82-1](#) [BGA622H6820XTSA1](#) [BGA 728L7 E6327](#) [BGB719N7ESDE6327XTMA1](#) [HMC397-SX](#) [HMC405](#) [HMC561-SX](#) [HMC8120-SX](#)
[HMC8121-SX](#) [HMC-ALH382-SX](#) [HMC-ALH476-SX](#) [SE2433T-R](#) [SMA3101-TL-E](#) [SMA39](#) [A66-1](#) [A66-3](#) [A67-1](#) [A81-2](#) [LX5535LQ](#)
[LX5540LL](#) [MAAM02350](#) [HMC3653LP3BETR](#) [HMC549MS8GETR](#) [HMC-ALH435-SX](#) [SMA101](#) [SMA32](#) [SMA411](#) [SMA531](#)
[SST12LP19E-QX6E](#) [WPM0510A](#) [HMC5929LS6TR](#) [HMC5879LS7TR](#) [HMC1087F10](#) [HMC1086](#) [HMC1016](#) [SMA1212](#) [MAX2689EWS+T](#)
[MAAMSS0041TR](#) [MAAM37000-A1G](#) [LTC6430AIUF-15#PBF](#) [SMA70-2](#) [SMA4011](#) [A231](#) [HMC-AUH232](#) [LX5511LQ](#) [LX5511LQ-TR](#)
[HMC7441-SX](#) [HMC-ALH310](#) [XD1001-BD-000V](#) [A4011](#)