

### Product Description

Qorvo's TGA2611-SM is a packaged broadband Low Noise Amplifier fabricated on Qorvo's QGaN25 0.25 um GaN on SiC process. The TGA2611-SM operates from 2 to 6 GHz and typically provides >18 dBm P1dB, > 22 dB of small signal gain and 30 dBm of OTOI with 1.0 dB NF. In addition to the high overall electrical performance, this GaN amplifier also provides a high level of input power robustness which allows more flexibility in designing the receive chain circuit protection.

The TGA2611-SM is available in a low cost, surface mount 20-lead 4x4 mm plastic QFN. It is ideally suited to support both radar and satellite communication applications.

Both RF ports have intergraded DC blocking caps and are fully matched to 50 ohms.

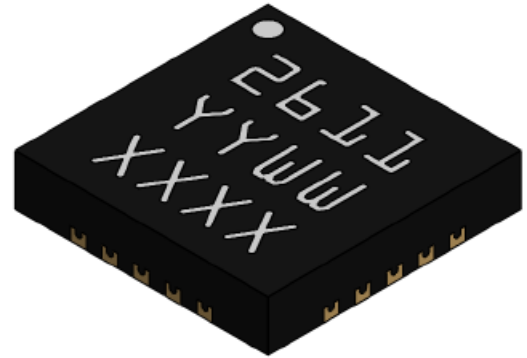

### Functional Block Diagram

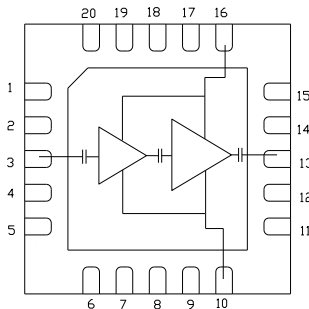

### Applications

- Commercial & Military Radar
- Communications

### Product Features

- Frequency Range: 2 – 6 GHz
- NF: 1.0 dB
- OTOI: 30 dBm @  $P_{OUT}/Tone = 18$  dBm
- Small Signal Gain: 22 dB
- Return Loss: > 10 dB
- P1dB: 18 dBm;  $P_{SAT} = 26$  dBm @  $P_{IN} = 10$  dBm
- Bias:  $V_D = 10$  V,  $I_{DQ} = 100$  mA;  $V_G = -2.3$  V (Typical)
- Package Dimensions: 4.0 x 4.0 x 0.85 mm

### Ordering Information

Part No.	Description
TGA2611-SM	2 – 6 GHz GaN LNA
1097070	TGA2611-SM Evaluation Board

### Absolute Maximum Ratings

Parameter	Range / Value	Units
Drain Voltage ( $V_D$ )	+40	V
Gate Voltage ( $V_G$ )	-5 to 0	V
Drain Current ( $I_D$ )	300	mA
Gate Current ( $I_G$ )	17	mA
Power Dissipation, 85 °C ( $P_{DISS}$ )	6	W
RF Input Power, CW, 50 $\Omega$	30	dBm
Channel Temperature ( $T_{CH}$ )	+275	°C
Mounting Temperature (30 seconds maximum)	+260	°C
Storage Temperature	-55 to +150	°C

Exceeding any one or a combination of the Absolute Maximum Rating conditions may cause permanent damage to the device. Extended application of Absolute Maximum Rating conditions to the device may reduce device reliability.

### Recommended Operating Conditions

Parameter	
Drain Voltage ( $V_D$ )	10 V
Gate Voltage ( $V_G$ )	-2.3 V Typical
Quiescent Drain Current ( $I_{DQ}$ )	100 mA
Temperature ( $T_{BASE}$ )	-40 to 85 °C

Electrical performance is measured under conditions noted in the electrical specifications table. Specifications are not guaranteed over all recommended operating conditions.

### Electrical Specifications

Parameter	Conditions	Min	Typ	Max	Units
Operational Frequency Range		2		6	GHz
Small Signal Gain			> 22		dB
Input Return Loss			> 10		dB
Output Return Loss			> 10		dB
Noise Figure			1		dB
Output Power @ 1 dB Gain Compression ( $P_{1dB}$ )			> 18		dBm
Output TOI	$P_{OUT}/Tone = 18\text{ dBm}$ , $\Delta f = 10\text{ MHz}$		30		dBm
Small Signal Gain Temperature Coefficient			-0.03		dB/°C
Noise Figure Temperature Coefficient			0.007		dB/°C

Test conditions unless otherwise noted:  $T_{BASE} = +25\text{ °C}$ ,  $V_D = 10\text{ V}$ ,  $I_{DQ} = 100\text{ mA}$ ,  $V_G = -2.3\text{ V}$  Typical, CW

### Thermal and Reliability Information

Parameter	Values	Units	Conditions
Thermal Resistance ( $\theta_{JC}$ ) <sup>(1,2,3)</sup>	12.6	°C/W	$T_{BASE} = +85\text{ °C}$ , $V_D = 10\text{ V}$ , $I_{DQ} = 100\text{ mA}$ , $I_{D\_DRIVE} = 195\text{ mA}$ , $P_{IN} = 10\text{ dBm}$ , $P_{OUT} = 28\text{ dBm}$ , Freq. = 4 GHz, $P_{DISS} = 1.3\text{ W}$ , CW
Channel Temperature ( $T_{CH}$ )	101.4	°C	

Notes:

1. Thermal resistance is measured to package backside
2. Base or ambient temperature is 85 °C
3. Refer to the following document: [GaN Device Channel Temperature, Thermal Resistance, and Reliability Estimates](#)

### Performance Plots – Small Signal

Conditions unless otherwise specified:  $V_D = 10\text{ V}$ ,  $I_{DQ} = 100\text{ mA}$ ,  $V_G = -2.3\text{ V}$  Typical, CW

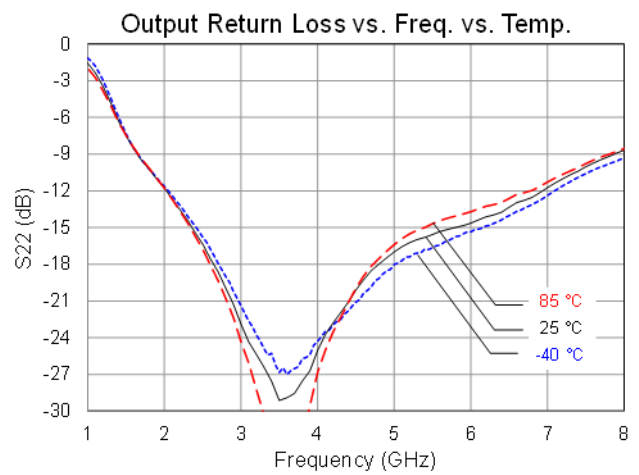
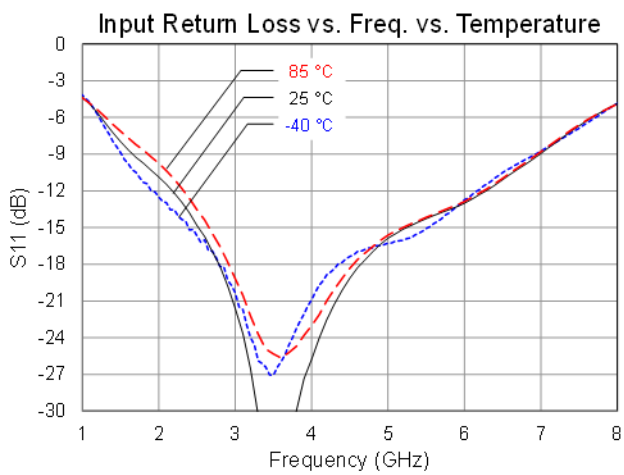
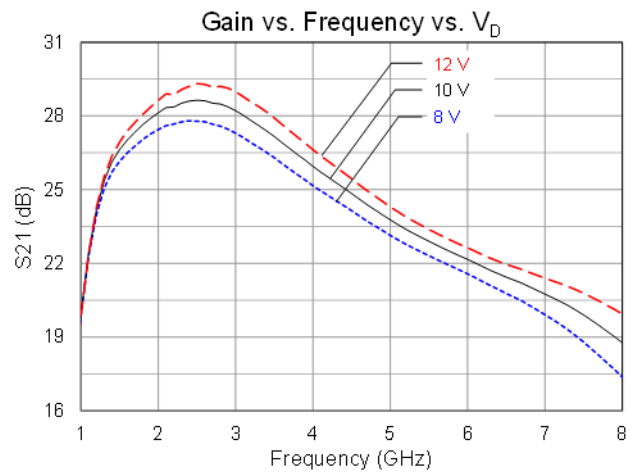
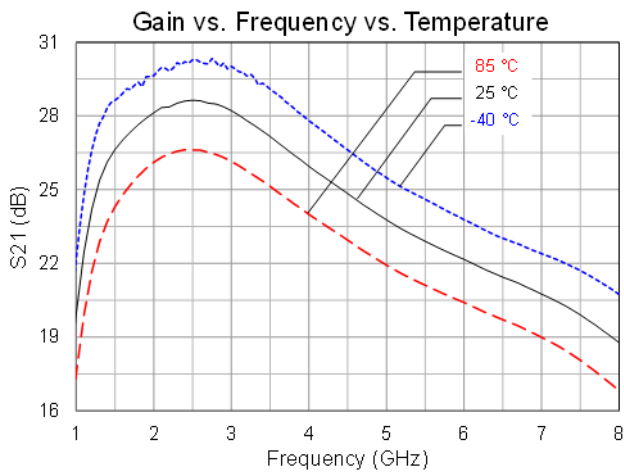
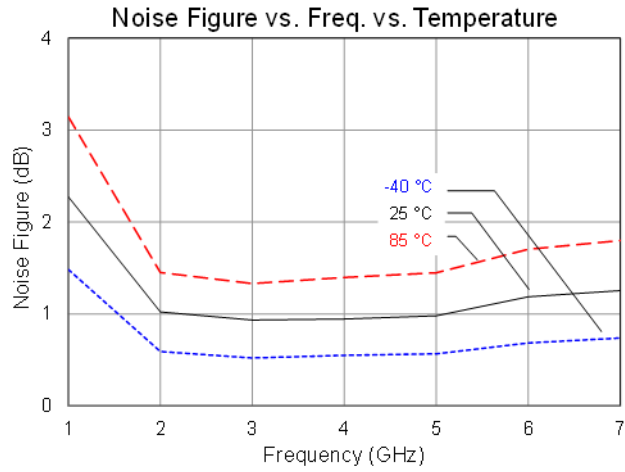

### Performance Plots – Large Signal

Conditions unless otherwise specified:  $V_D = 10\text{ V}$ ,  $I_{DQ} = 100\text{ mA}$ ,  $V_G = -2.3\text{ V}$  Typical, CW

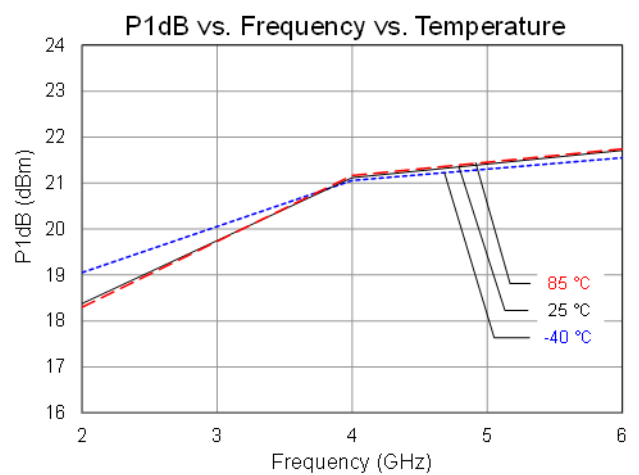
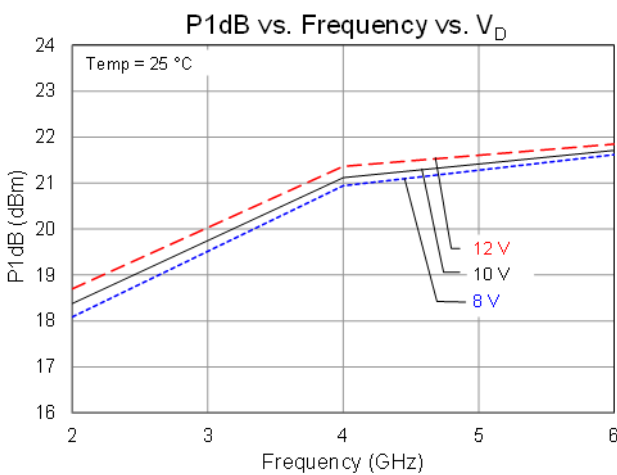
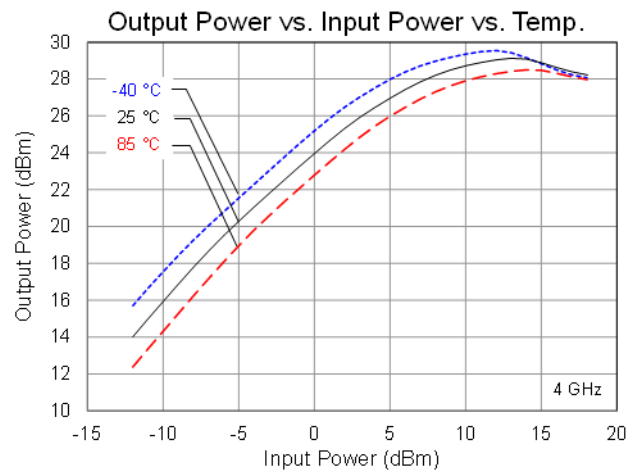
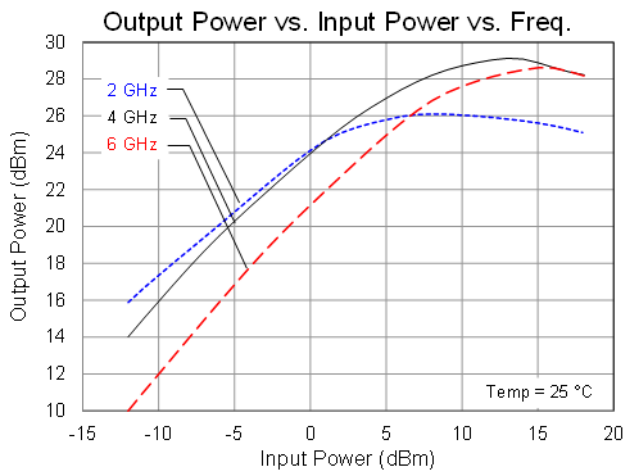
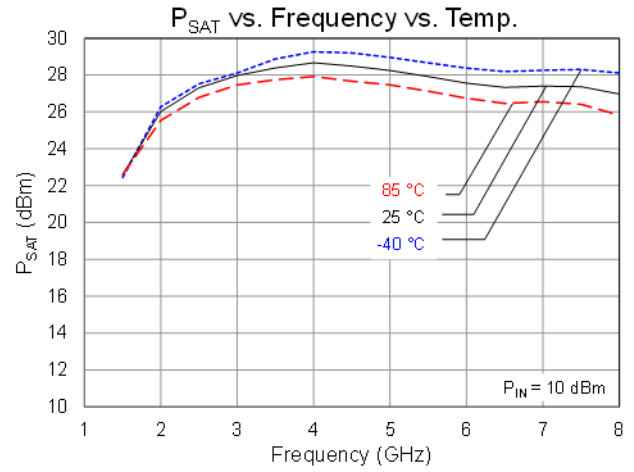
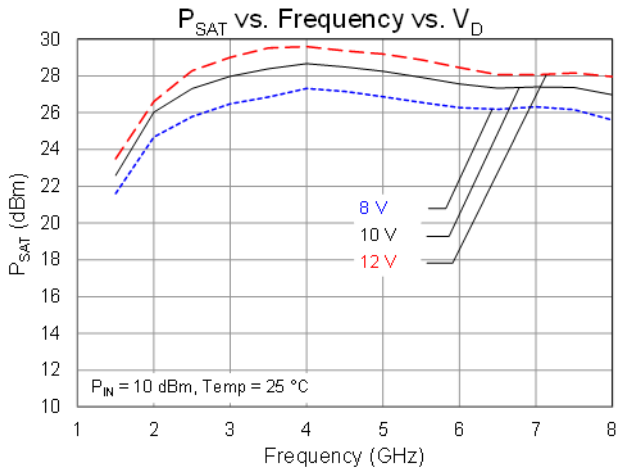

### Performance Plots – Large Signal

Conditions unless otherwise specified:  $V_D = 10\text{ V}$ ,  $I_{DQ} = 100\text{ mA}$ ,  $V_G = -2.3\text{ V}$  Typical, CW

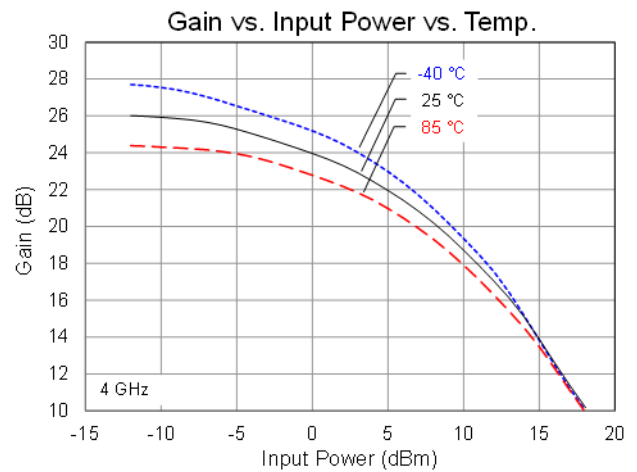
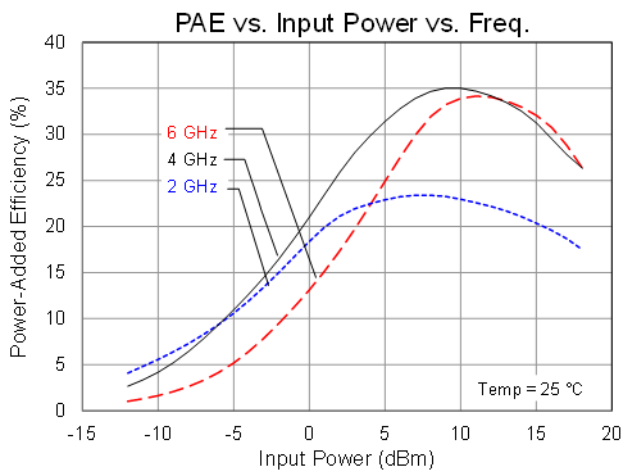
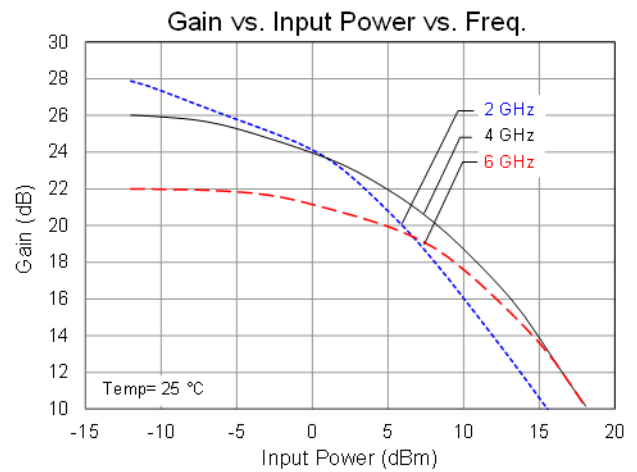
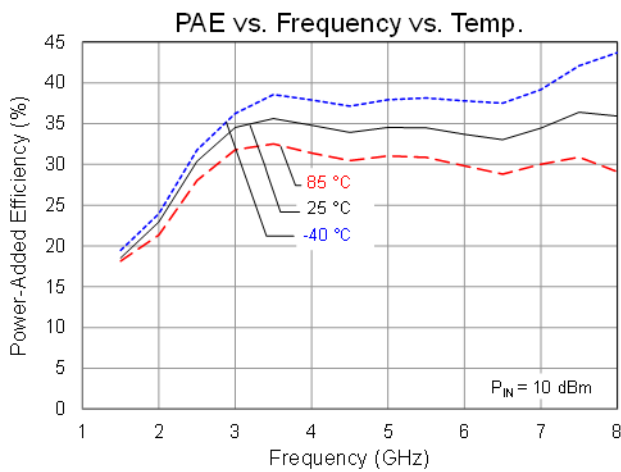
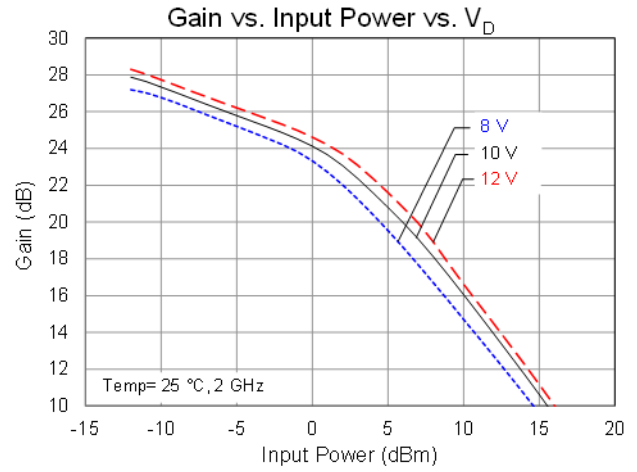
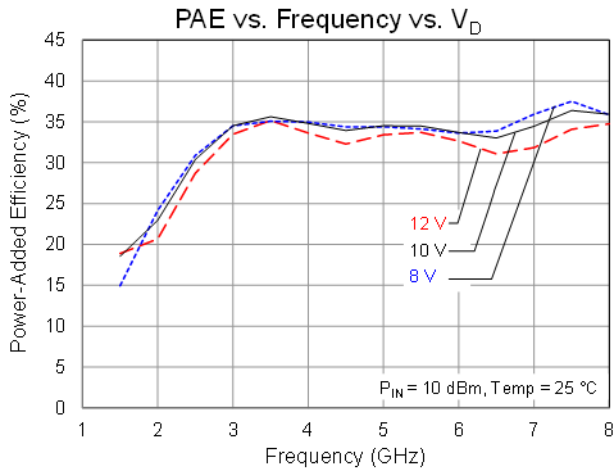

### Performance Plots – Large Signal

Conditions unless otherwise specified:  $V_D = 10\text{ V}$ ,  $I_{DQ} = 100\text{ mA}$ ,  $V_G = -2.3\text{ V}$  Typical, CW

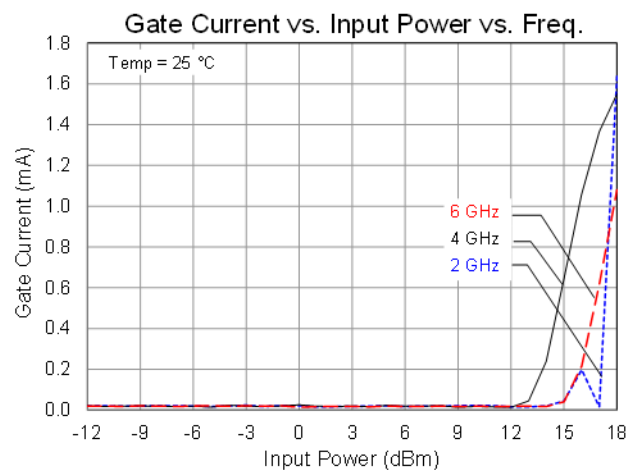
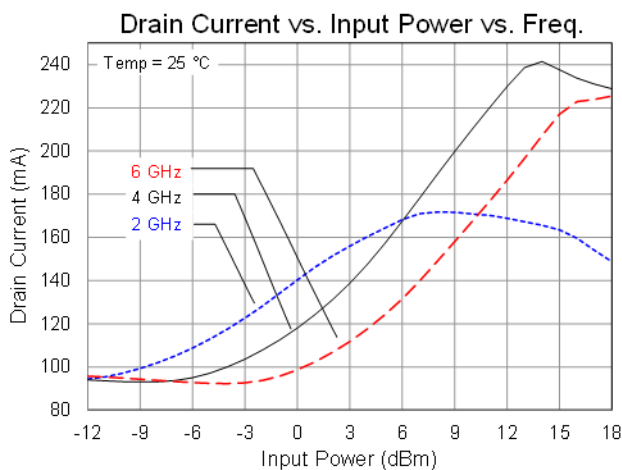
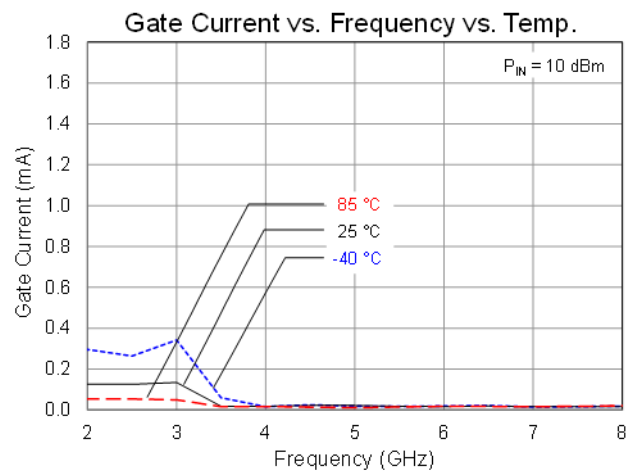
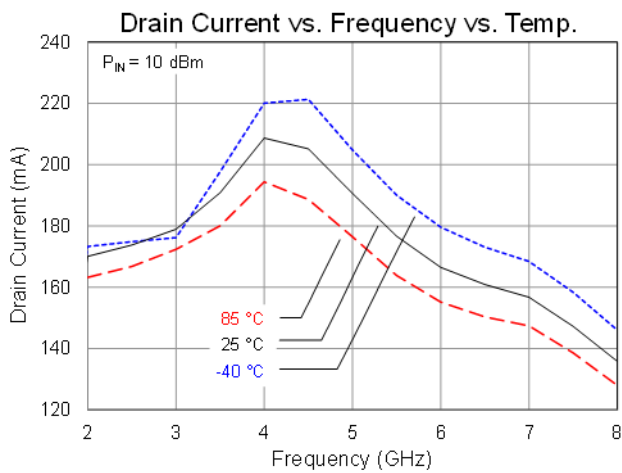
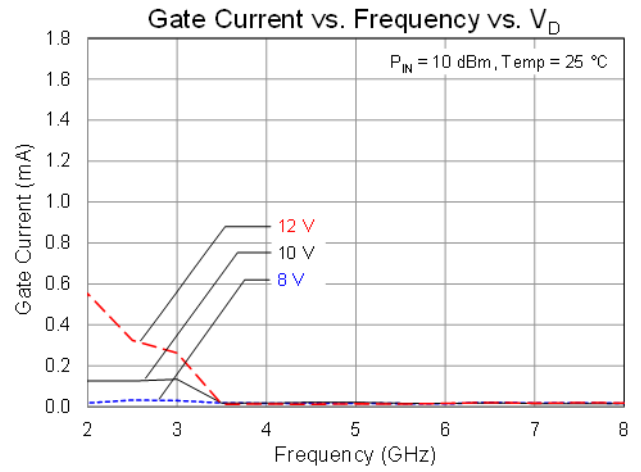
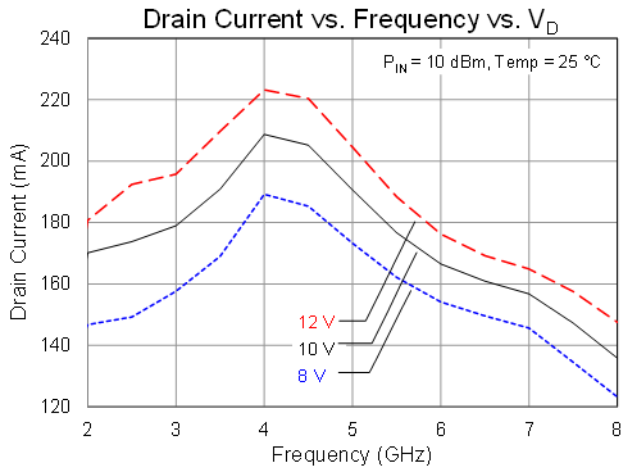

### Performance Plots – Linearity

Conditions unless otherwise specified:  $V_D = 10\text{ V}$ ,  $I_{DQ} = 100\text{ mA}$ ,  $V_G = -2.3\text{ V}$  Typical, CW

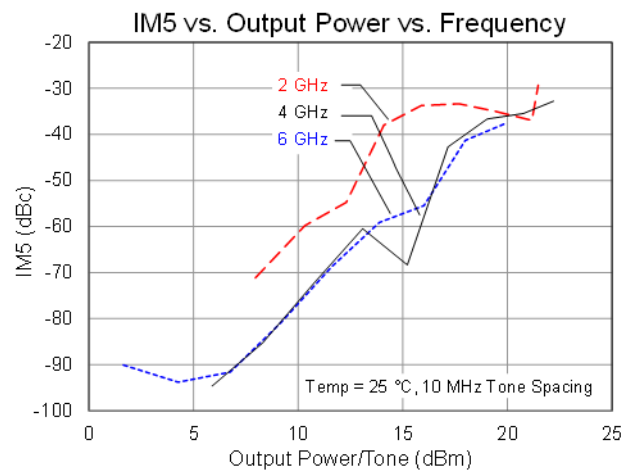
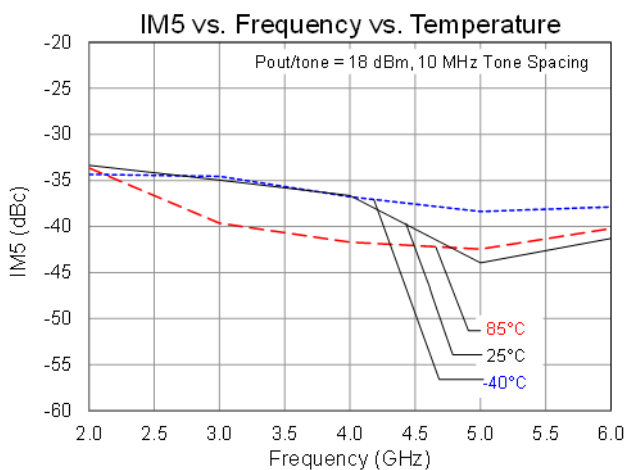
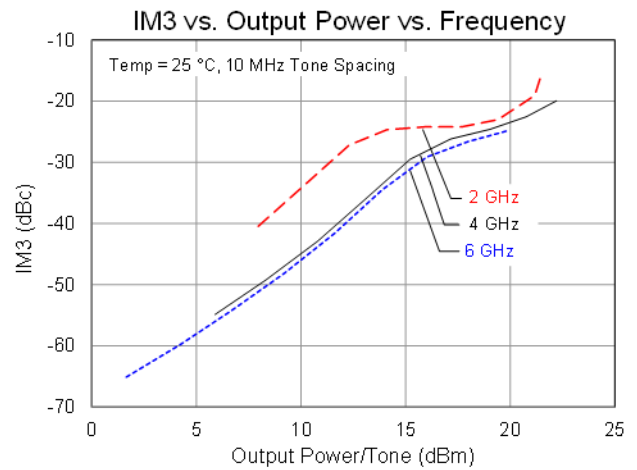
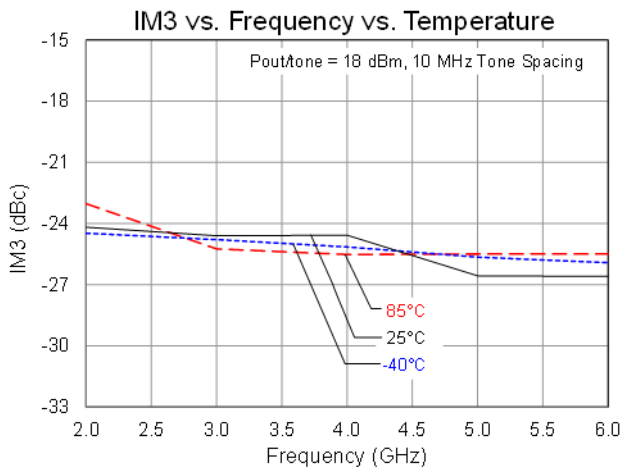
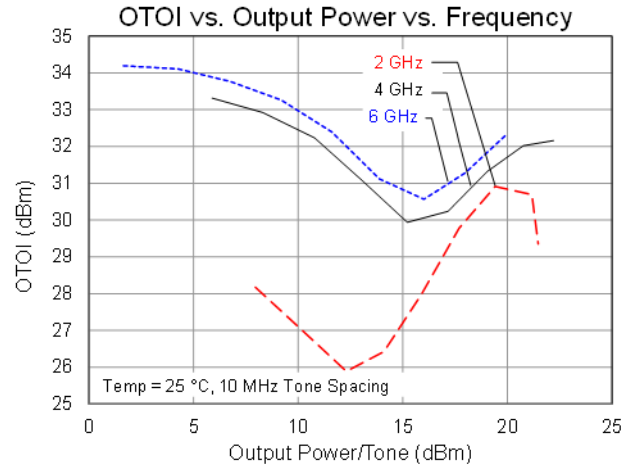
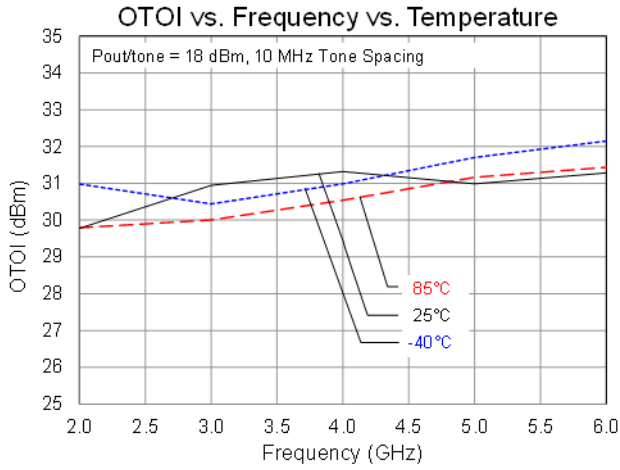

**Performance Plots – Harmonic**

Conditions unless otherwise specified:  $V_D = 10\text{ V}$ ,  $I_{DQ} = 100\text{ mA}$ ,  $V_G = -2.3\text{ V}$  Typical, CW

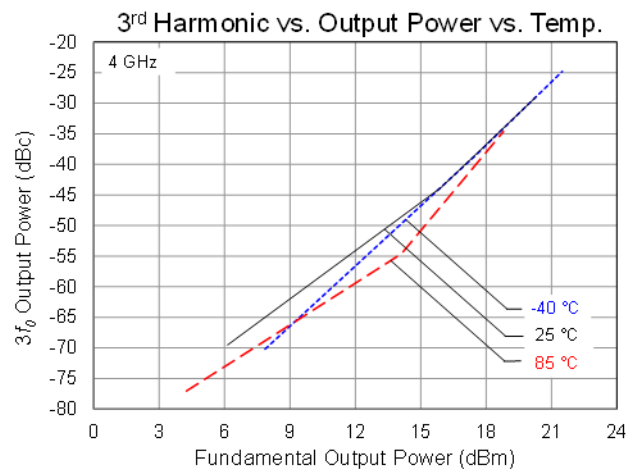
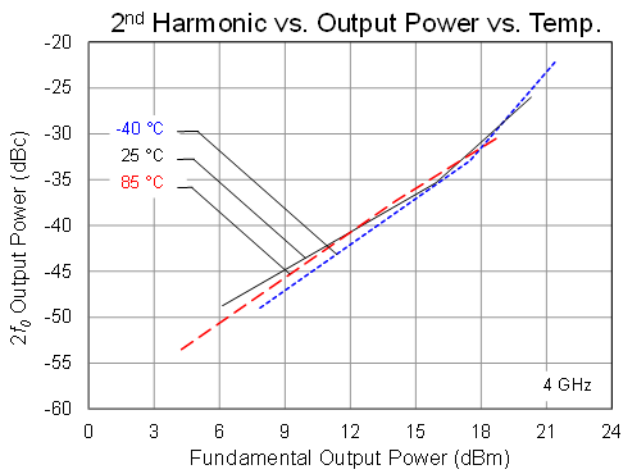
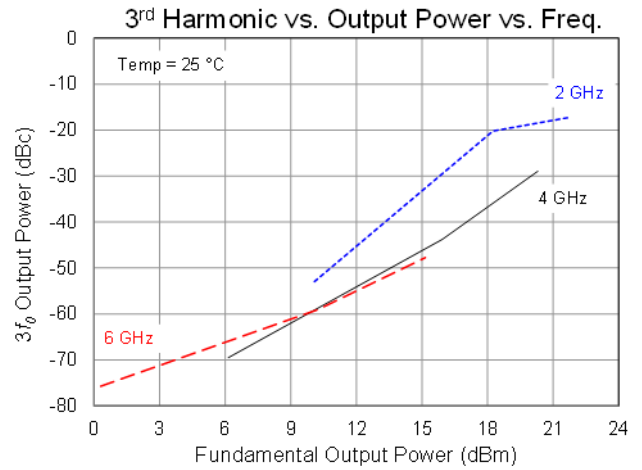
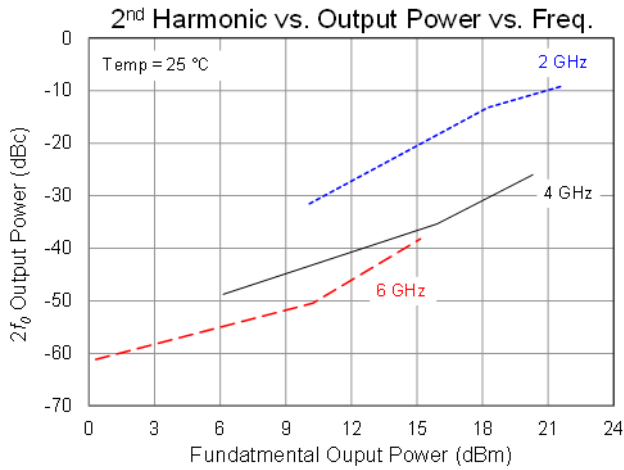



**Application Circuit**

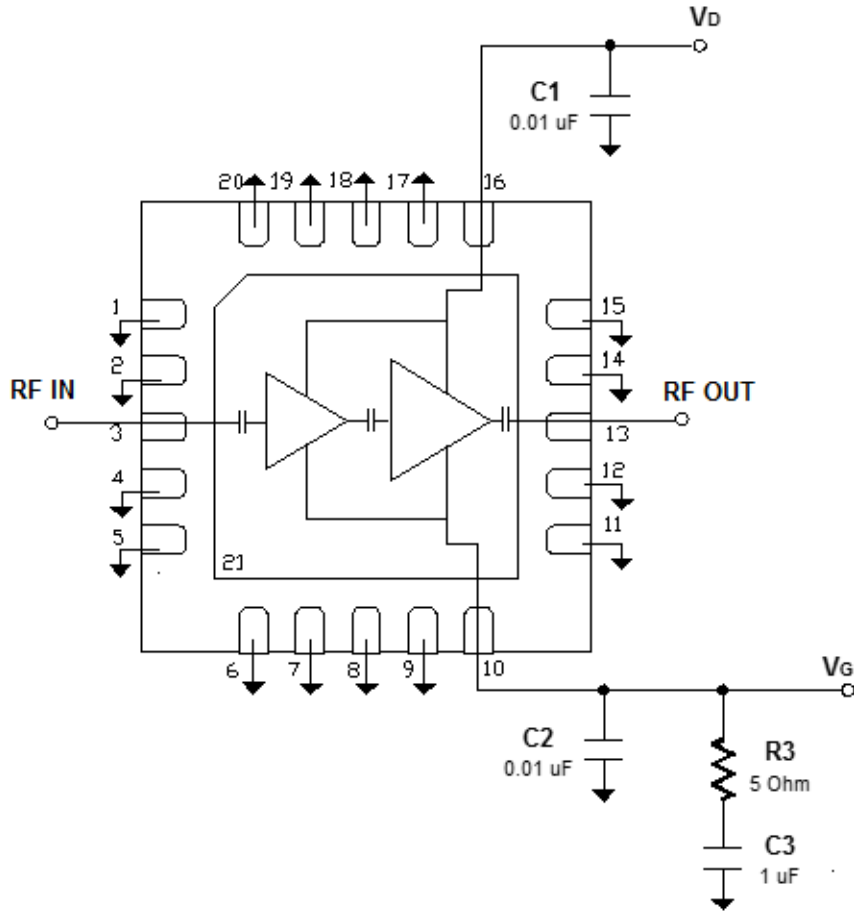

**Bias Up Procedure**

1. Set  $I_D$  limit to 300 mA,  $I_G$  limit to 3 mA
2. Set  $V_G$  to -5.0V
3. Set  $V_D$  +10V
4. Adjust  $V_G$  more positive until  $I_{DQ} = 100$  mA.  
( $V_G \sim -2.3$  V Typical)
5. Apply RF signal

**Bias Down Procedure**

1. Turn off RF signal
2. Set  $V_G$  to -5.0V. Ensure  $I_{DQ} \sim 0$ mA
3. Set  $V_D$  to 0V
4. Turn off  $V_D$  supply
5. Turn off  $V_G$  supply

**Evaluation Board Layout**

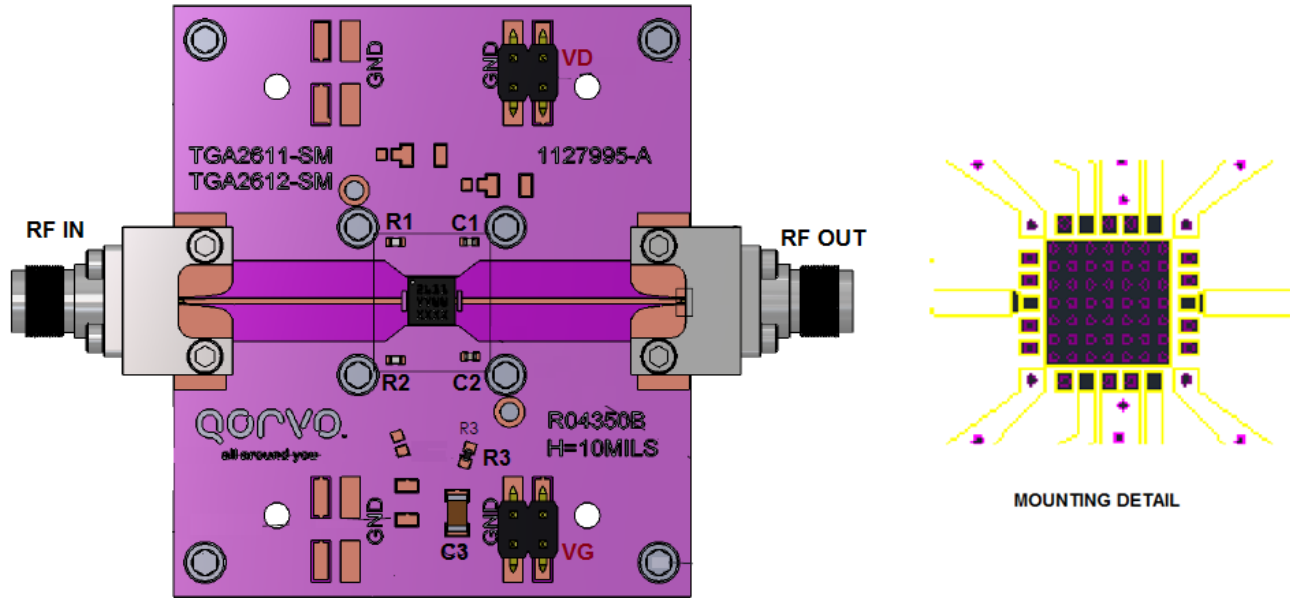

The microstrip line at the connector interface is optimized for the Southwest Microwave end launch connector 1092-01A-5.

The pad pattern shown has been developed and tested for optimized assembly at Qorvo. The PCB land pattern has been developed to accommodate lead tolerances. Since processes vary from company to company, careful process development is recommended

Multiple vias should be employed under the package center paddle to minimize inductance resistance.

**Bill of Materials**

Reference Des.	Value	Description	Manuf.	Part Number
C1, C2	0.01 $\mu$ F	Cap, 0402, 50 V, 10%, X7R	Various	–
C3	1 $\mu$ F	Cap, 1206, 50 V, 10%, X7R	Various	–
R1, R2	0 $\Omega$	Res, 0402, 5% (Required for above EVB design)	Various	
R3	5 $\Omega$	Res, 0603, 5%	Various	–

**Mechanical Information, Pin Configuration and Description**

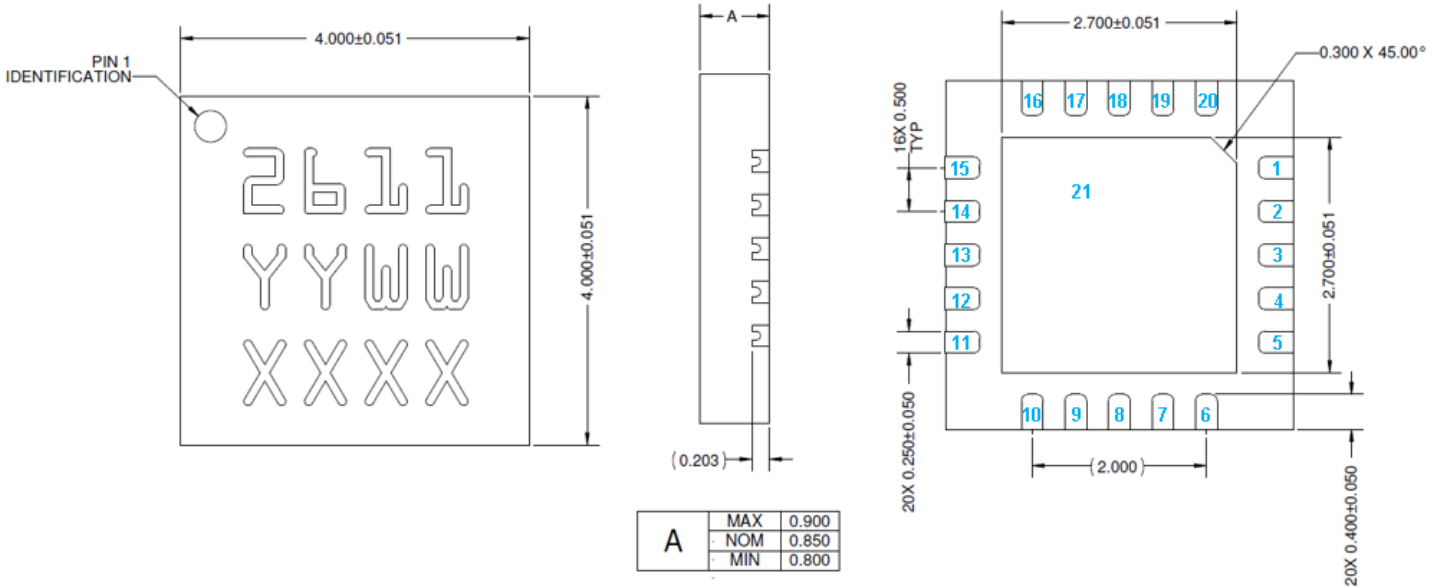

Dimensions: mm

Tolerance unless otherwise specified: +/- 0.127, angles = 0.5 °

Package is mold encapsulated with NiPdAu plated leads

Part Marking: 2611 = Part Number, YY = Part Assembly Year, WW = Part Assembly Week, MXXX = Batch ID

Pin No.	Label	Description
1-2, 4-9, 11, 12, 14, 15, 17-20	N/C	Recommend grounding on PCB for improved package isolation. Connected to ground paddle (21)
3	RF Input	RF input, matched to 50 Ω, DC blocked
10	V <sub>G</sub>	Gate voltage. Bias network required
13	RF Output	RF output, matched to 50 Ω, DC blocked
16	V <sub>D</sub>	Drain voltage. Bias network required.
21	GND	Ground Paddle. Multiple vias should be employed to minimize inductance and thermal resistance.

**Solderability**

- Compatible with the latest version of J-STD-020, Lead-free solder, 260 °C peak reflow temperature.

**Recommended Soldering Temperature Profile**

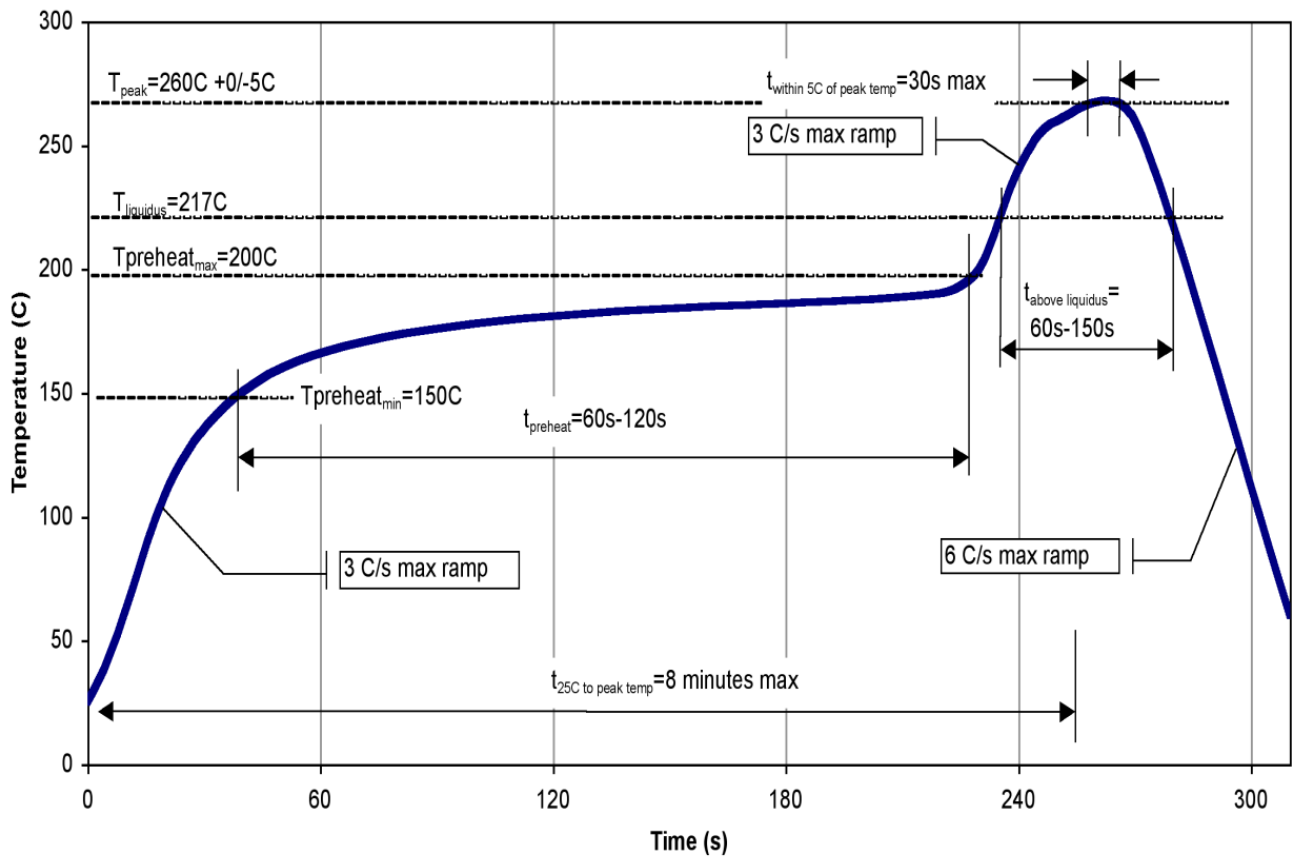

## Handling Precautions

Parameter	Rating	Standard
ESD – Human Body Model (HBM)	Class 1A	ESDA / JEDEC JS-001-2012
ESD – Charge Device Model (CDM)	Class C2	JESD22-C101
MSL – 260 °C Convection Reflow	Level 3	JEDEC standard IPC/JEDEC-J-STD-020



Caution!  
ESD-Sensitive Device

## RoHS Compliance

This product is compliant with the 2011/65/EU RoHS directive (Restrictions on the Use of Certain Hazardous Substances in Electrical and Electronic Equipment), as amended by Directive 2015/863/EU. This product also has the following attributes:

- Lead Free
- Halogen Free (Chlorine, Bromine)
- Antimony Free
- TBBP-A (C<sub>15</sub>H<sub>12</sub>Br<sub>4</sub>O<sub>2</sub>) Free
- SVHC Free

## Contact Information

For the latest specifications, additional product information, worldwide sales and distribution locations:

Tel: 1-844-890-8163

Web: [www.qorvo.com](http://www.qorvo.com)

Email: [customer.support@qorvo.com](mailto:customer.support@qorvo.com)

## Important Notice

The information contained herein is believed to be reliable; however, Qorvo makes no warranties regarding the information contained herein and assumes no responsibility or liability whatsoever for the use of the information contained herein. All information contained herein is subject to change without notice. Customers should obtain and verify the latest relevant information before placing orders for Qorvo products. The information contained herein or any use of such information does not grant, explicitly or implicitly, to any party any patent rights, licenses, or any other intellectual property rights, whether with regard to such information itself or anything described by such information. **THIS INFORMATION DOES NOT CONSTITUTE A WARRANTY WITH RESPECT TO THE PRODUCTS DESCRIBED HEREIN, AND QORVO HEREBY DISCLAIMS ANY AND ALL WARRANTIES WITH RESPECT TO SUCH PRODUCTS WHETHER EXPRESS OR IMPLIED BY LAW, COURSE OF DEALING, COURSE OF PERFORMANCE, USAGE OF TRADE OR OTHERWISE, INCLUDING THE IMPLIED WARRANTIES OF MERCHANTABILITY AND FITNESS FOR A PARTICULAR PURPOSE.**

Without limiting the generality of the foregoing, Qorvo products are not warranted or authorized for use as critical components in medical, life-saving, or life-sustaining applications, or other applications where a failure would reasonably be expected to cause severe personal injury or death.

Copyright 2018 © Qorvo, Inc. | Qorvo is a registered trademark of Qorvo, Inc.

## X-ON Electronics

Largest Supplier of Electrical and Electronic Components

*Click to view similar products for [RF Amplifier](#) category:*

*Click to view products by [Qorvo](#) manufacturer:*

Other Similar products are found below :

[A82-1](#) [BGA622H6820XTSA1](#) [BGA 728L7 E6327](#) [BGB719N7ESDE6327XTMA1](#) [HMC397-SX](#) [HMC405](#) [HMC561-SX](#) [HMC8120-SX](#)  
[HMC8121-SX](#) [HMC-ALH382-SX](#) [HMC-ALH476-SX](#) [SE2433T-R](#) [SMA3101-TL-E](#) [SMA39](#) [A66-1](#) [A66-3](#) [A67-1](#) [LX5535LQ](#) [LX5540LL](#)  
[MAAM02350](#) [HMC3653LP3BETR](#) [HMC549MS8GETR](#) [HMC-ALH435-SX](#) [SMA101](#) [SMA32](#) [SMA411](#) [SMA531](#) [SST12LP17E-XX8E](#)  
[SST12LP19E-QX6E](#) [WPM0510A](#) [HMC5929LS6TR](#) [HMC5879LS7TR](#) [HMC1126](#) [HMC1087F10](#) [HMC1086](#) [HMC1016](#) [SMA1212](#)  
[MAX2689EWS+T](#) [MAAMSS0041TR](#) [MAAM37000-A1G](#) [LTC6430AIUF-15#PBF](#) [CHA5115-QDG](#) [SMA70-2](#) [SMA4011](#) [A231](#) [HMC-](#)  
[AUH232](#) [LX5511LQ](#) [LX5511LQ-TR](#) [HMC7441-SX](#) [HMC-ALH310](#)