

Applications

- Commercial and Military Radar
- Communications

Product Features

- Frequency Range: 16 – 18GHz
- P_{SAT} : 18.5dBm
- P1dB: 16.5dBm
- Small Signal Gain: 20dB
- Input Return Loss: 16dB
- Output Return Loss: 25dB
- Bias: $V_D = 6V$, $I_{DQ} = 30mA$, $V_G = -0.6V$ Typical
- Package Dimensions: 3 x 3 x 0.53 mm

General Description

TriQuint's TGA2620-SM is a package Ku-band MMIC driver amplifier fabricated on TriQuint's 0.15um GaAs pHEMT production process. Operating from 16-18GHz, the TGA2620-SM provides more than 18.5dBm saturated output power, 16.5dBm P1dB and 20dB small signal gain.

Fully matched to 50 ohms with integrated DC blocking capacitors on both I/O ports allows for simple system integration. The TGA2620-SM is an ideal choice for general purpose amplification across both commercial and military Ku-band platforms.

The TGA2620-SM is available in a low cost, surface mount, 14-lead 3x3mm AIN QFN package base with air cavity Liquid Crystal Polymer (LCP) lid.

Lead-free and RoHS compliant

Evaluation Boards are available upon request.

QFN 3x3 mm 14L

Functional Block Diagram

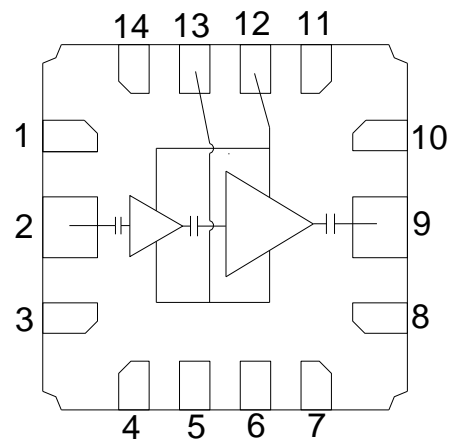

Pad Configuration

Pad No.	Symbol
1, 3, 8, 10	GND
2	RF In
4 - 7, 11, 14	N/C
9	RF Out
12	V_D
13	V_G

Ordering Information

Part	ECCN	Description
TGA2620-SM	EAR99	16 – 18GHz Driver Amplifier

Absolute Maximum Ratings

Parameter	Value
Drain Voltage (V_D)	6.5V
Gate Voltage Range (V_G)	-2 to 0V
Drain Current (I_D)	65mA
Gate Current (I_G)	-0.5 to 5mA
Power Dissipation, 85°C (P_{DISS})	0.3W
Input Power, CW, 50 Ω , (P_{IN})	15dBm
Channel temperature (T_{CH})	150°C
Mounting Temperature (30 Seconds)	260°C
Storage Temperature	-55 to 150°C

Operation of this device outside the parameter ranges given above may cause permanent damage. These are stress ratings only, and functional operation of the device at these conditions is not implied.

Recommended Operating Conditions

Parameter	Value
Drain Voltage (V_D)	6V
Drain Current (I_{DQ})	30mA
Gate Voltage (V_G)	-0.6V Typical

Electrical specifications are measured at specified test conditions. Specifications are not guaranteed overall operating conditions.

Electrical Specifications

Test conditions unless otherwise noted: 25°C, $V_D = 6V$, $I_{DQ} = 30mA$, $V_G = -0.6V$ Typical

Parameter	Min	Typical	Max	Units
Operational Frequency Range	16		18	GHz
Small Signal Gain		20		dB
Input Return Loss		16		dB
Output Return Loss		25		dB
Output Power (P_{SAT})		18.5		dBm
Output Power at 1 dB Gain Compression		16.5		dBm
Power Added Efficiency (P_{SAT})		24		%
Gain Temperature Coefficient		-0.02		dB/°C

Thermal and Reliability Information

Parameter	Test Conditions	Value	Units
Thermal Resistance (θ_{JC}) ⁽¹⁾	$T_{base} = 85^{\circ}C$	226	$^{\circ}C/W$
Channel Temperature (T_{CH}) (Under RF drive)	$V_D = 6V, I_{DQ} = 30mA, I_{D_Drive} = 53mA, CW$	142	$^{\circ}C$
Median Lifetime (T_M)	$P_{IN} = 5dBm, P_{OUT} = 18.3dBm, P_{DISS} = 250mW$	2.6×10^6	Hrs

Notes:

1. Thermal resistance measured at back of the package.

Median Lifetime

Test Conditions: $V_D = 6.5V$; Failure Criteria = 10% reduction in I_{D_MAX}

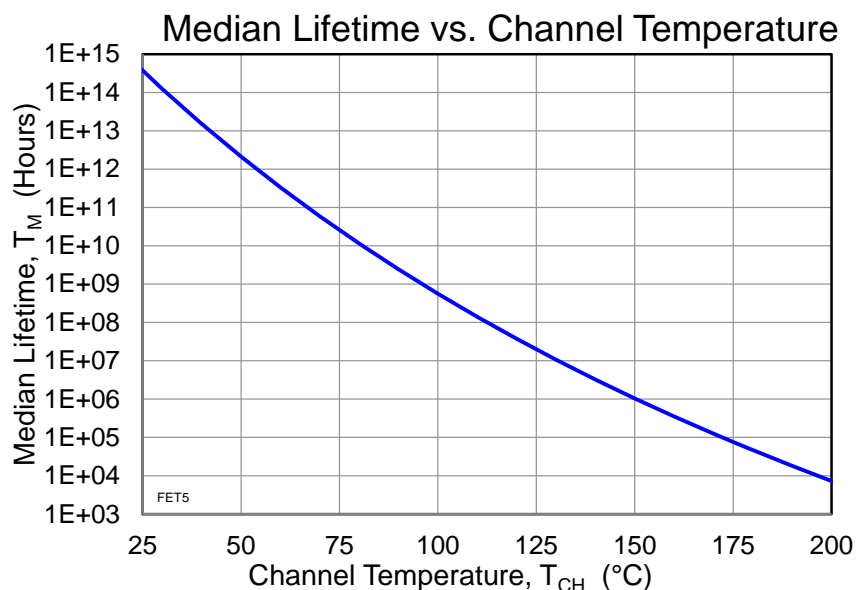

Typical Performance: Small Signal

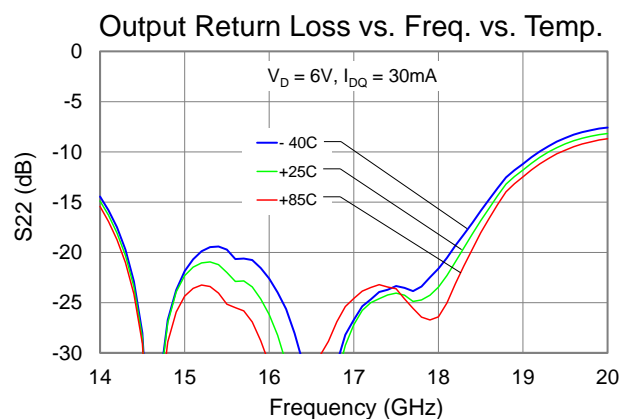
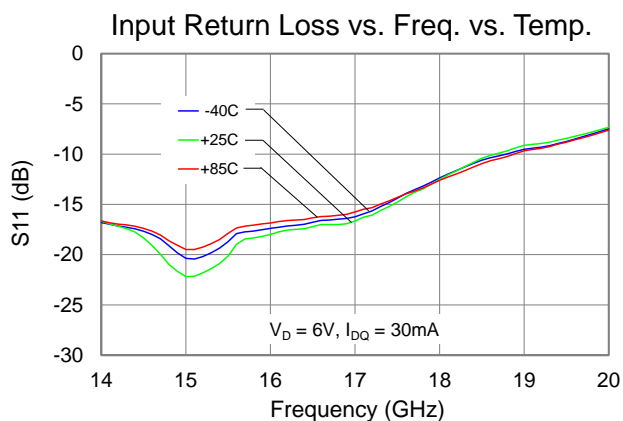
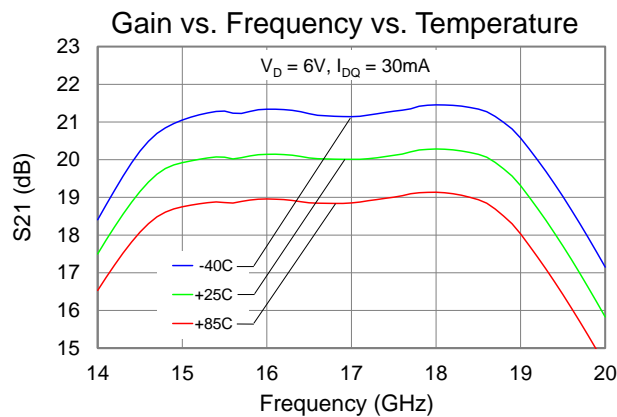
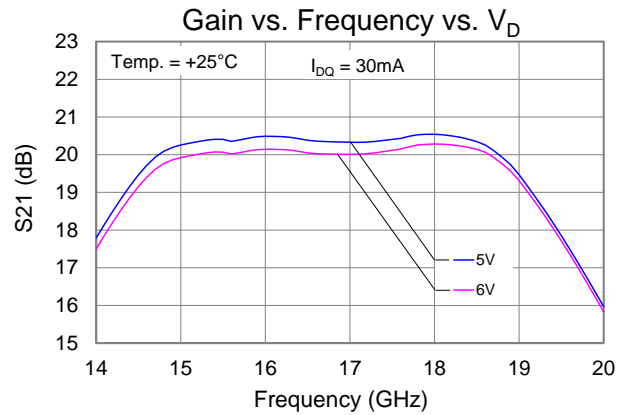
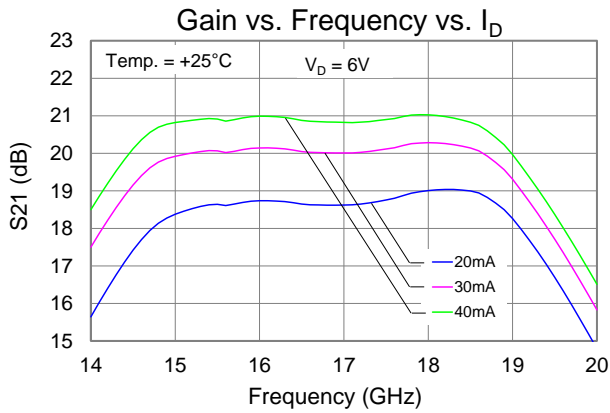

Typical Performance: Large Signal

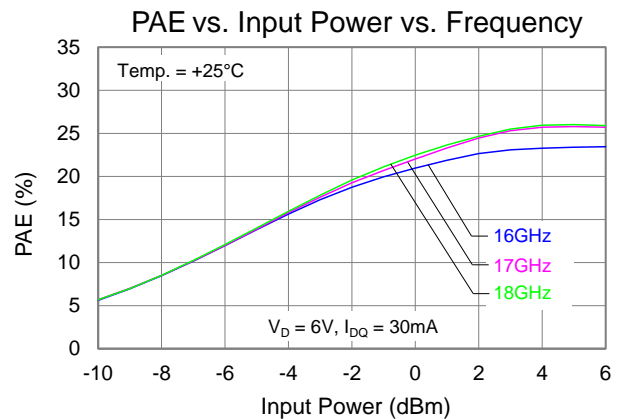
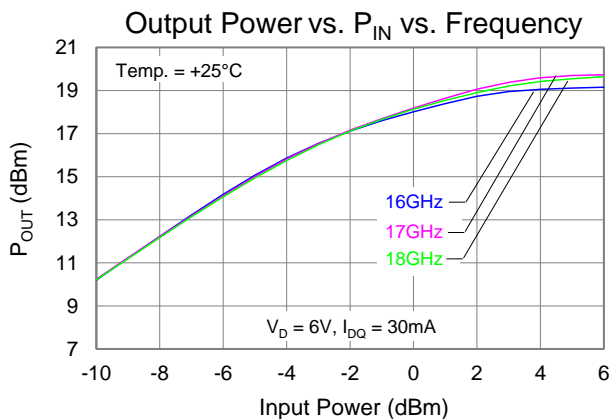
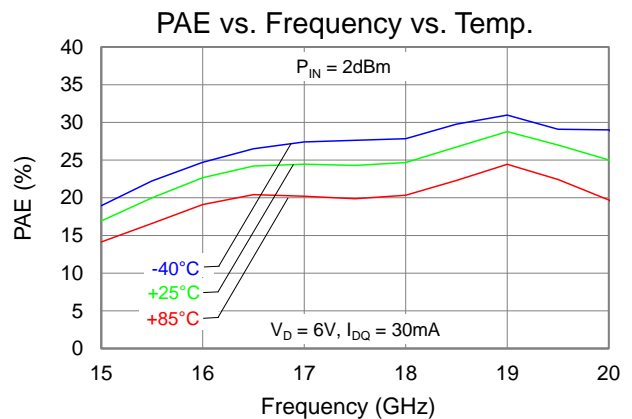
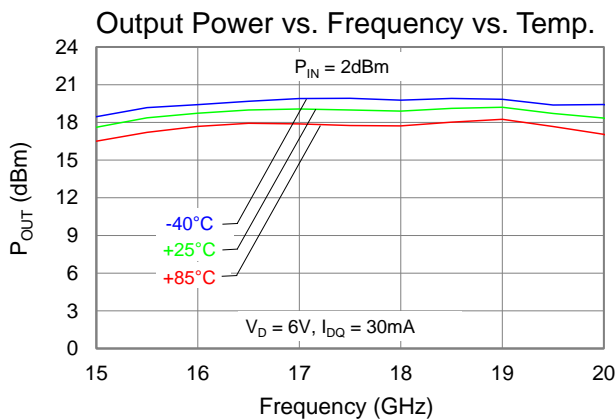
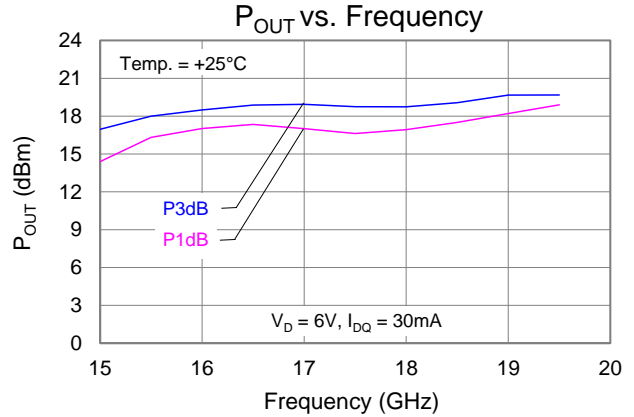
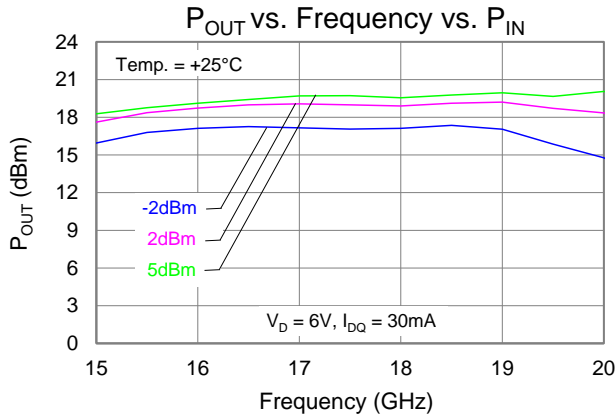

Typical Performance: Large Signal

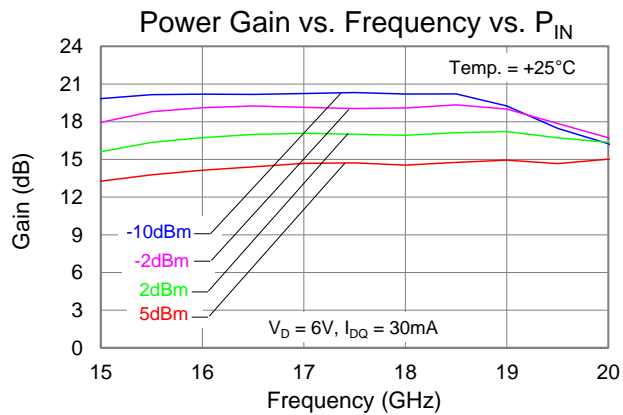
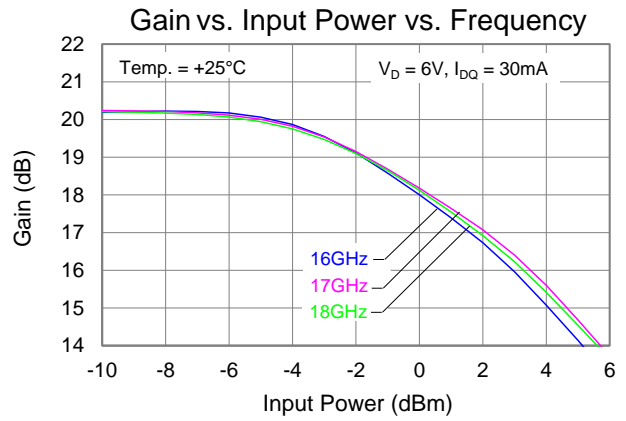
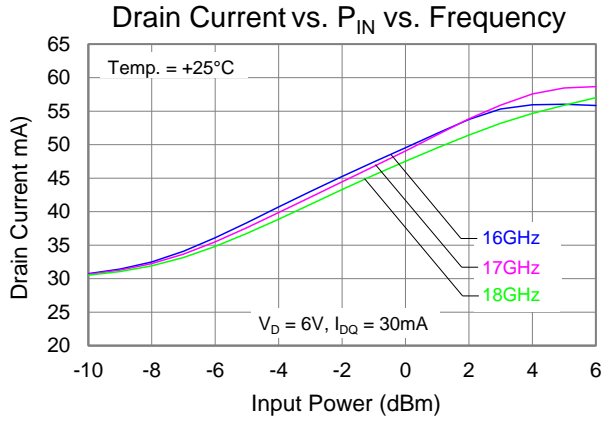

Typical Performance At Die Level (Linearity)

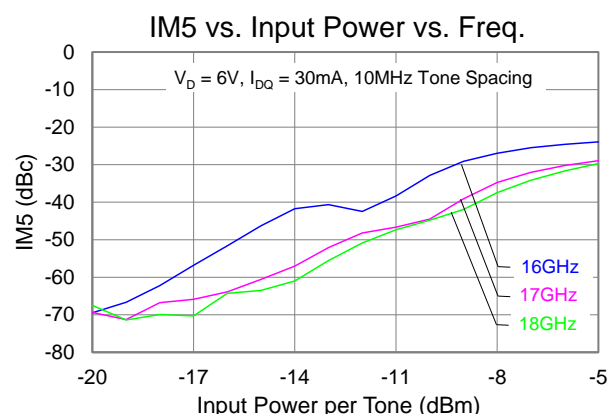
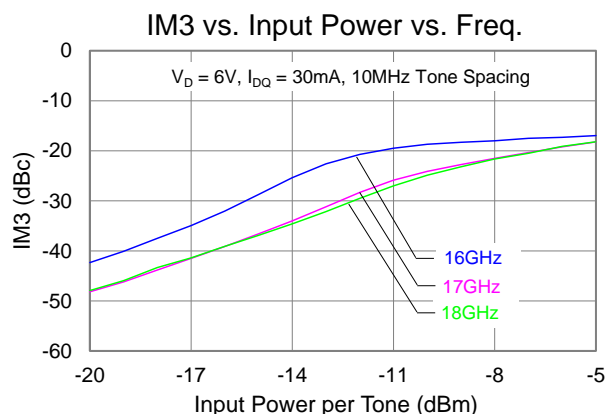
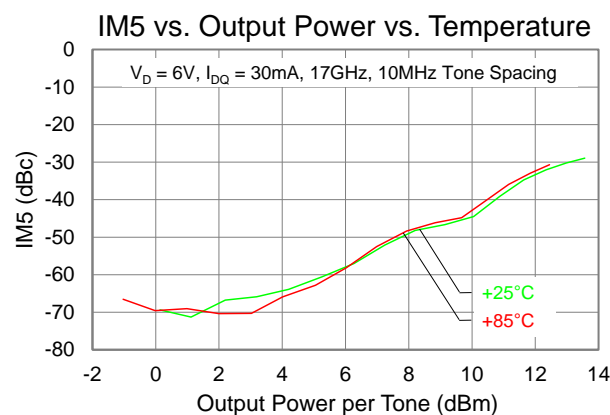
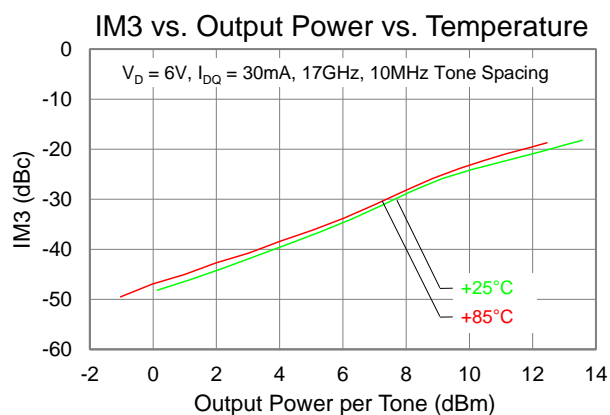
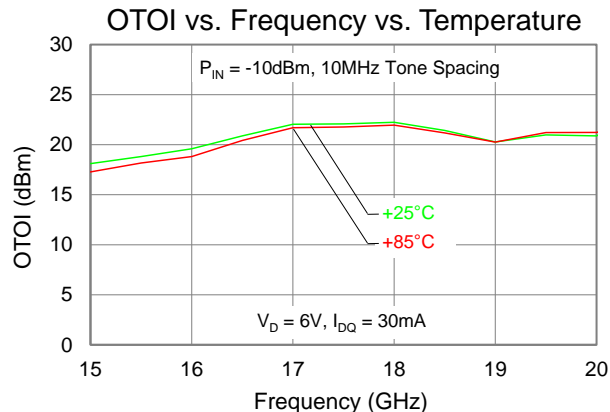
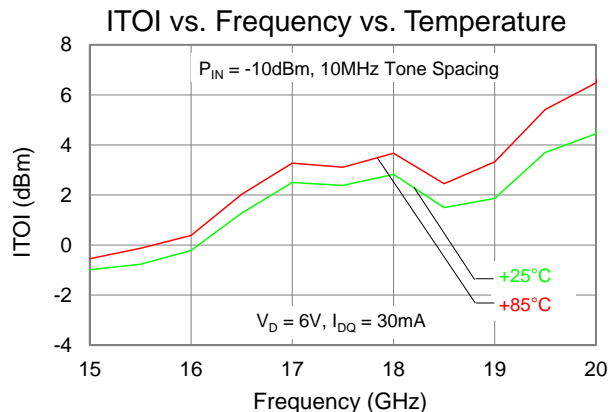

Typical Performance At Die Level (Harmonics)

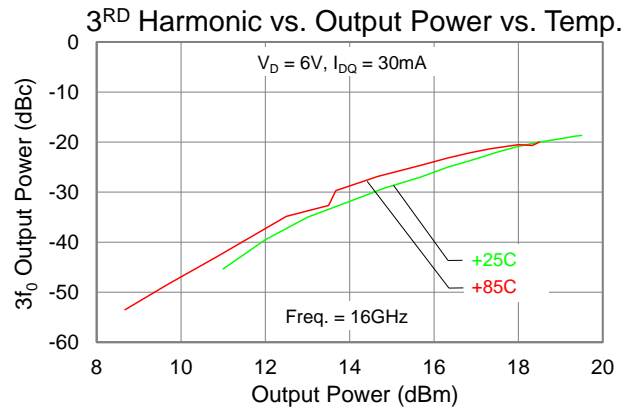
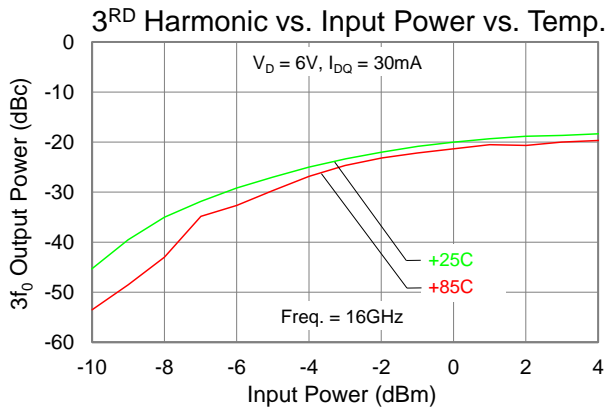
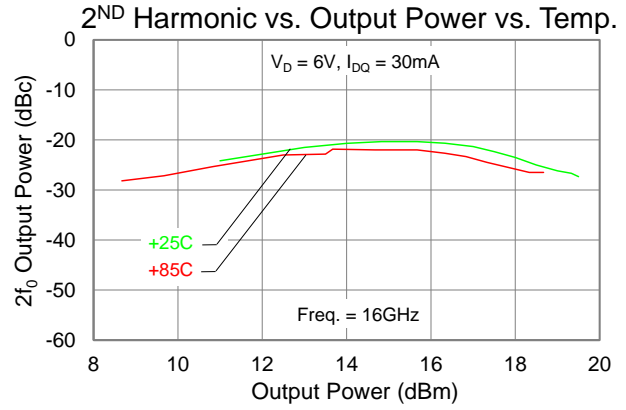
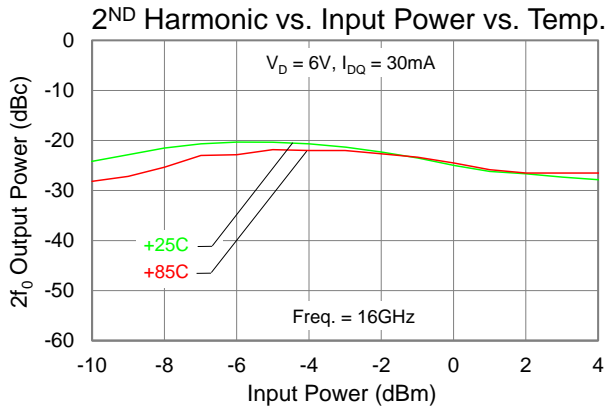

Application Circuit

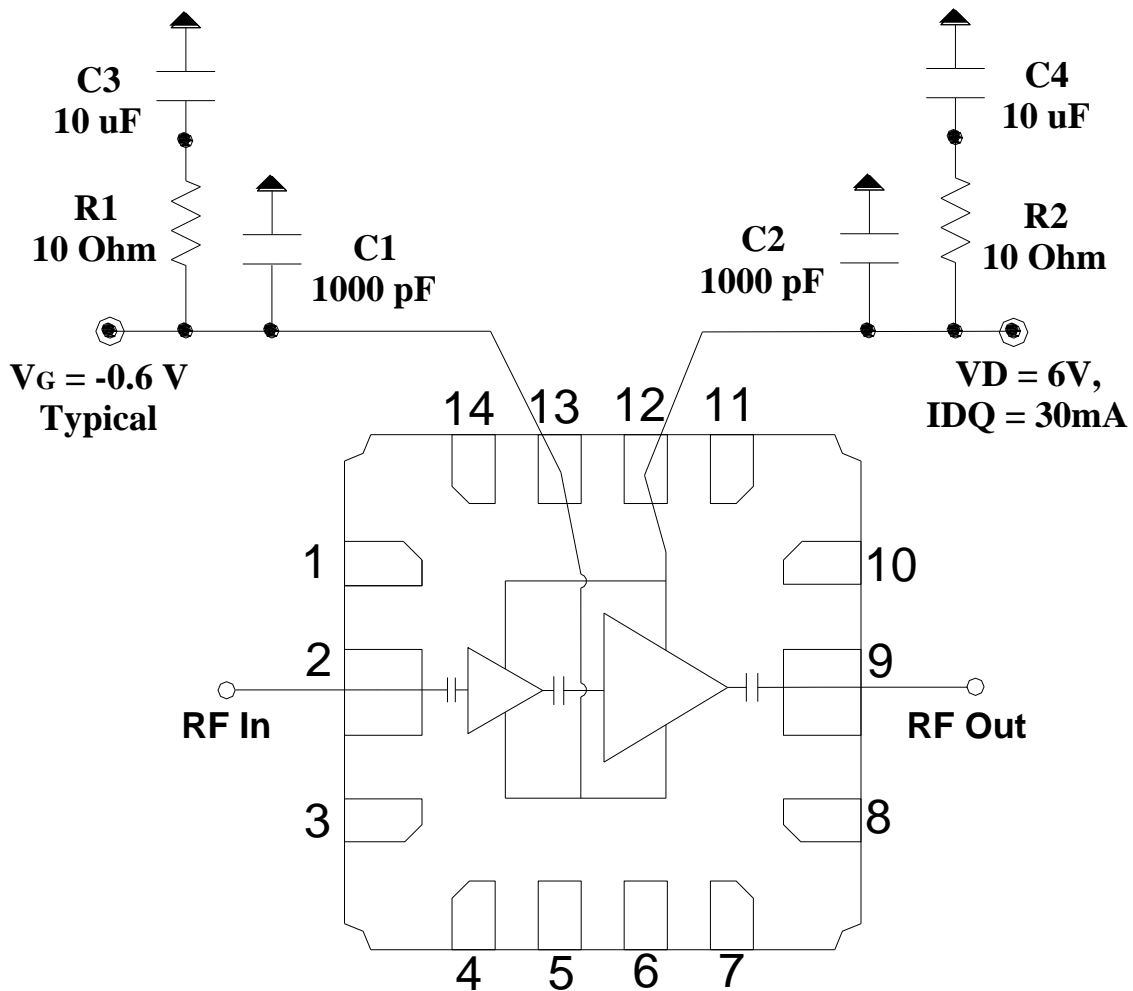

Bias-up Procedure

1. Set I_D limit to 60mA, I_G limit to 4mA
2. Set V_G to -1.5V
3. Set V_D +6V
4. Adjust V_G more positive until $I_{DQ} = 30\text{mA}$ ($V_G \sim -0.6\text{V}$ Typical)
5. Apply RF signal

Bias-down Procedure

1. Turn off RF signal
2. Reduce V_G to -1.5V. Ensure $I_{DQ} \sim 0\text{mA}$
3. Set V_D to 0V
4. Turn off V_D supply
5. Turn off V_G supply

Evaluation Board

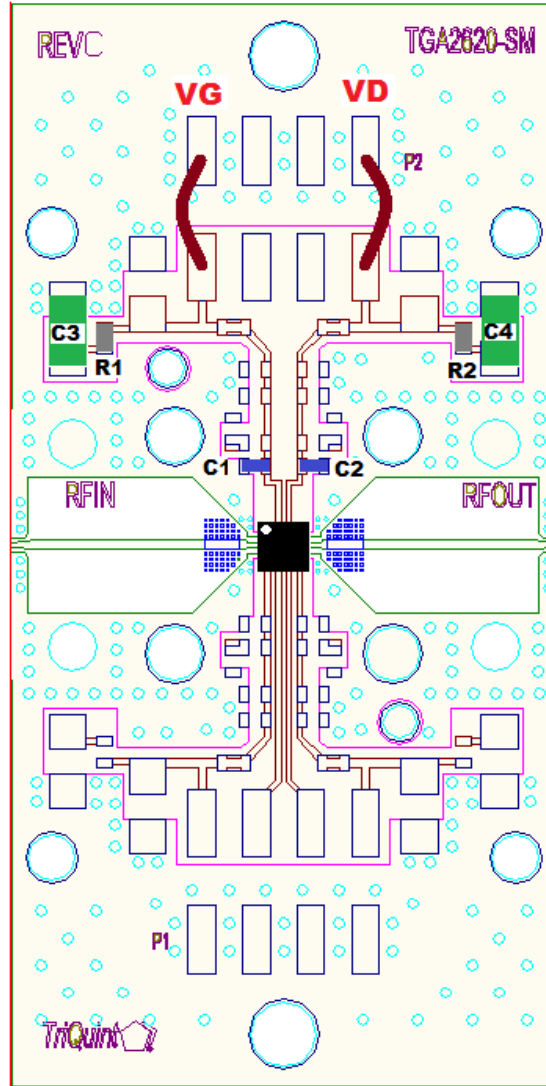

Bill of Material

Reference Des.	Value	Description	Manuf.	Part Number
C1 – C2	1000pF	Cap, 0402, 50 V, 10%, X7R	Various	
C3 – C4	10µF	Cap, 1206, 50 V, 20%, X5R	Various	
R1 – R2	10Ω	Res, 0402, 5%	Various	

Pin Layout

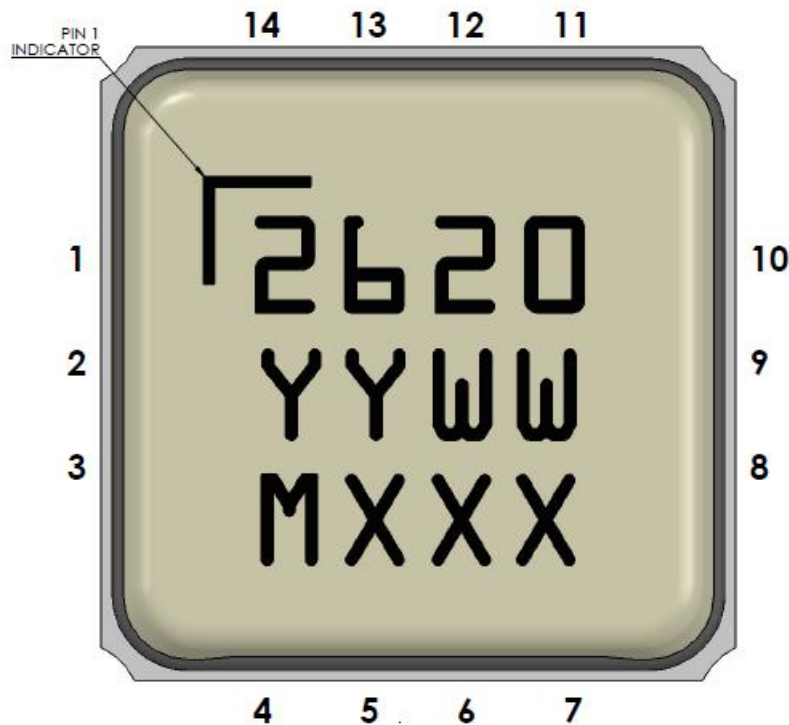

Pin Description

Pin No.	Symbol	Description
1, 3, 8, 10	GND	Ground
2	RF IN	Input; matched to 50 Ω. DC Blocked
4 – 7, 11, 14	NC	No Connection – Recommended grounding on PCB.
9	RF OUT	Output; matched to 50 Ω. DC Blocked
12	DRAIN	Drain voltage; bias network is required; see Application Circuit on page 9 as an example.
13	GATE	Gate voltage; bias network is required; see Application Circuit on page 9 as an example.
15	GND	Ground Paddle. Multiple vias should be employed to minimize inductance and thermal resistance.

Mechanical Information

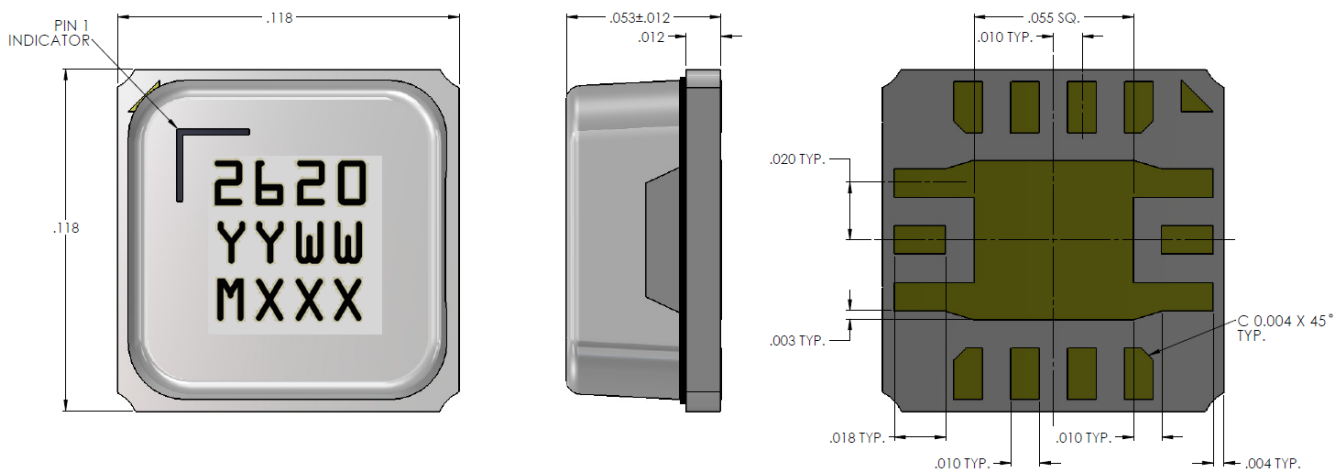

Units: inches

Tolerances: unless specified

x.xxx = ± 0.005

Materials:

Base: Aluminum Nitride (AlN)

Lid: Liquid Crystal Polymer (LCP)

Contact Pin Plating:

Electroless Gold (Au): 0.5 – 1.5 µm
Over

Electroless Nickel (Ni): 2.0 µm min.

Marking:

2620: Part number

YY: Part Assembly year

WW: Part Assembly week

MXXX: Batch ID

Recommended Soldering Temperature Profile

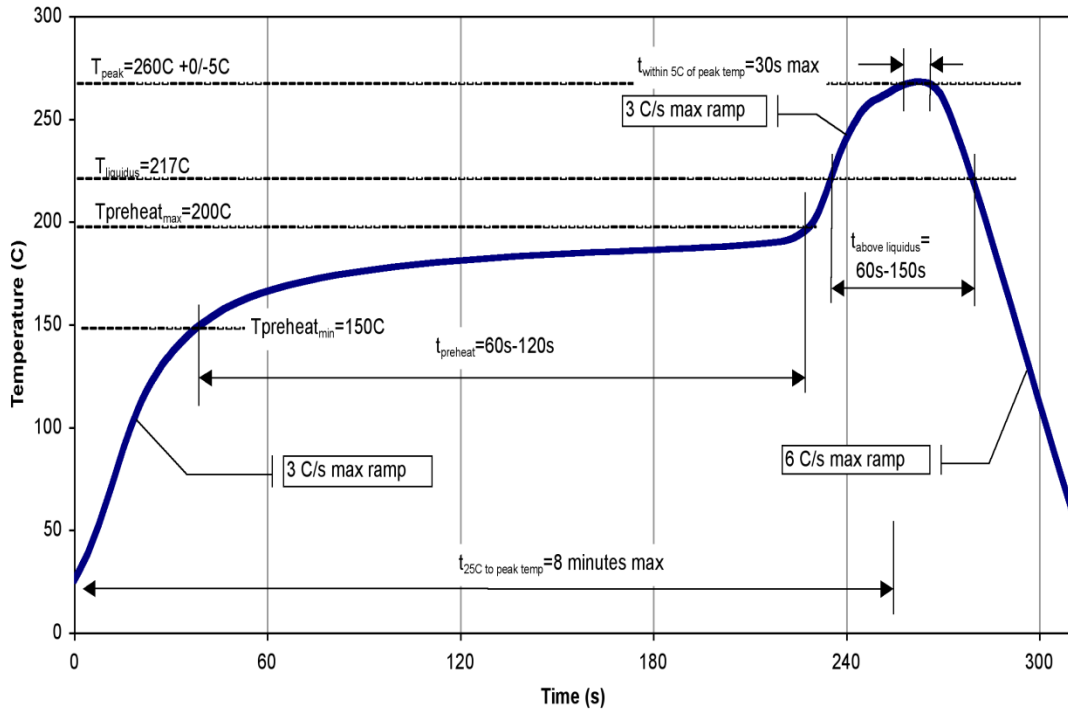

Product Compliance Information**ESD Sensitivity Ratings**

Caution! ESD-Sensitive Device

ESD Rating: TBD
Value: TBD
Test: Human Body Model (HBM)
Standard: JEDEC Standard JESD22-A114

MSL Rating

Level TBD at 260°C convection reflow
This part is rated Moisture Sensitivity Level TBD at TBD
°C per JEDEC standard IPC/JEDEC J-STD-020.

ECCN

US Department of Commerce: EAR99

Solderability

Compatible with the latest version of J-STD-020 Lead free solder, 260°C.

RoHS Compliance

This part is compliant with EU 2002/95/EC RoHS directive (Restrictions on the Use of Certain Hazardous Substances in Electrical and Electronic Equipment).

This product also has the following attributes:

- Lead Free
- Halogen Free (Chlorine, Bromine)
- Antimony Free
- TBBP-A (C₁₅H₁₂Br₄O₂) Free
- PFOS Free
- SVHC Free

Contact Information

For the latest specifications, additional product information, worldwide sales and distribution locations, and information about TriQuint:

Web: www.triquint.com
Email: info-sales@triquint.com

Tel: +1.972.994.8465
Fax: +1.972.994.8504

For technical questions and application information: Email: info-products@triquint.com**Important Notice**

The information contained herein is believed to be reliable. TriQuint makes no warranties regarding the information contained herein. TriQuint assumes no responsibility or liability whatsoever for any of the information contained herein. TriQuint assumes no responsibility or liability whatsoever for the use of the information contained herein. The information contained herein is provided "AS IS, WHERE IS" and with all faults, and the entire risk associated with such information is entirely with the user. All information contained herein is subject to change without notice. Customers should obtain and verify the latest relevant information before placing orders for TriQuint products. The information contained herein or any use of such information does not grant, explicitly or implicitly, to any party any patent rights, licenses, or any other intellectual property rights, whether with regard to such information itself or anything described by such information.

TriQuint products are not warranted or authorized for use as critical components in medical, life-saving, or life-sustaining applications, or other applications where a failure would reasonably be expected to cause severe personal injury or death.

X-ON Electronics

Largest Supplier of Electrical and Electronic Components

Click to view similar products for [RF Amplifier](#) category:

Click to view products by [Qorvo](#) manufacturer:

Other Similar products are found below :

[A82-1](#) [BGA622H6820XTSA1](#) [BGA 728L7 E6327](#) [BGB719N7ESDE6327XTMA1](#) [HMC397-SX](#) [HMC405](#) [HMC561-SX](#) [HMC8120-SX](#)
[HMC8121-SX](#) [HMC-ALH382-SX](#) [HMC-ALH476-SX](#) [SE2433T-R](#) [SMA3101-TL-E](#) [SMA39](#) [A66-1](#) [A66-3](#) [A67-1](#) [LX5535LQ](#) [LX5540LL](#)
[MAAM02350](#) [HMC3653LP3BETR](#) [HMC549MS8GETR](#) [HMC-ALH435-SX](#) [SMA101](#) [SMA32](#) [SMA411](#) [SMA531](#) [SST12LP19E-QX6E](#)
[WPM0510A](#) [HMC5929LS6TR](#) [HMC5879LS7TR](#) [HMC1126](#) [HMC1087F10](#) [HMC1086](#) [HMC1016](#) [SMA1212](#) [MAX2689EWS+T](#)
[MAAMSS0041TR](#) [MAAM37000-A1G](#) [LTC6430AIUF-15#PBF](#) [SMA70-2](#) [SMA4011](#) [A231](#) [HMC-AUH232](#) [LX5511LQ](#) [LX5511LQ-TR](#)
[HMC7441-SX](#) [HMC-ALH310](#) [XD1001-BD-000V](#) [A4011](#)