

Product Description

Qorvo's TGA2958 is a driver amplifier fabricated on Qorvo's QGaN15 GaN on SiC process. The TGA2958 operates from 13 – 18 GHz and achieves 2 W of saturated output power with > 21 dB of large signal gain and at least 25% power-added efficiency.

The TGA2958 is an ideal choice to drive Qorvo's high performing Ku-band GaN HPA's allowing the user to operate the driver and HPA off similar voltage rails.

Fully matched to 50 ohms with integrated DC blocking capacitors on both I/O ports, the TGA2958 is ideally suited for a variety of military and commercial radar and communications applications.

Lead free and RoHS compliant.

Evaluation Boards are available upon request.

Functional Block Diagram

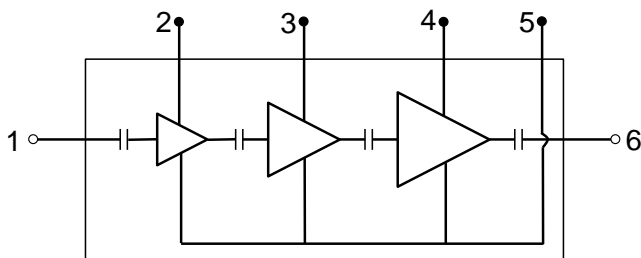

Product Features

- Frequency Range: 13 - 18 GHz
- P_{SAT} : >33 dBm at $P_{IN} = 12$ dBm
- PAE: > 25 % at $P_{IN} = 12$ dBm
- Small Signal Gain: > 25 dB
- Input Return Loss: > 7 dB
- Output Return Loss: > 8 dB
- Bias: $V_D = +20$ V, $I_{DQ} = 70$ mA, $V_G = -2.7$ V Typical
- Chip Dimensions: 1.25 x 2.14 x 0.10 mm
- Performance under CW operation

Applications

- Satellite Communications
- Data Links
- Radar
- General Purpose

Ordering Information

Part No.	Description
TGA2958	13 – 18 GHz 2 W GaN Driver Amplifier

Absolute Maximum Ratings

Parameter	Value / Range
Drain Voltage (V_D)	29.5 V
Gate Voltage Range (V_G)	-5 to 0 V
Drain Current – common drain	576 mA
- 1 st Stage (I_{D1})	72 mA
- 2 nd Stage (I_{D2})	192 mA
- 3 rd Stage (I_{D3})	384 mA
Gate Current at $T_{ch} = 200\text{ }^\circ\text{C}$:	
- 1 st Stage (I_{G1})	-0.2 to 1.2 mA
- 2 nd Stage (I_{G2})	-0.4 to 2.4 mA
- 3 rd Stage (I_{G3})	-0.8 to 2.4 mA
Power Dissipation (P_{DISS}), 85 °C	13 W
Input Power (P_{IN}), CW, 50 Ω , $V_D = 22\text{ V}$, $I_{DQ} = 70\text{ mA}$, 85 °C	27 dBm
Input Power (P_{IN}), CW, VSWR 3:1, $V_D = 22\text{ V}$, $I_{DQ} = 70\text{ mA}$, 85 °C	20 dBm
Mounting Temperature (30 Seconds)	320 °C
Storage Temperature	-55 to 150 °C

Operation of this device outside the parameter ranges given above may cause permanent damage. These are stress ratings only, and functional operation of the device at these conditions is not implied.

Recommended Operating

Parameter	Value / Range
Drain Voltage (V_D) CW	20 V
Drain Current (I_{DQ})	70 mA
Drain Current Under RF Drive (I_{D_DRIVE})	See plots p. 7
Gate Voltage (V_G)	-2.7 V (Typ.)
Gate Current Under RF Drive (I_{G_DRIVE})	See plots p. 7
Temperature (T_{BASE})	-40 to 85 °C

Electrical specifications are measured at specified test conditions. Specifications are not guaranteed over all recommended operating conditions.

Electrical Specifications

Parameter	Min	Typ	Max	Units
Operational Frequency Range	13		18	GHz
Small Signal Gain		> 25		dB
Input Return Loss		> 7		dB
Output Return Loss		> 8		dB
Output Power at $P_{IN} = 12\text{ dBm}$		> 33		dBm
Power Added Efficiency at $P_{IN} = 12\text{ dBm}$		> 25		%
Large Signal Gain at $P_{IN} = 12\text{ dBm}$		> 21		dB
IM3 ($P_{out}/\text{tone} = 24\text{ dBm}$, 1 MHz spacing)		-27		dBc
IM5 ($P_{out}/\text{tone} = 24\text{ dBm}$, 1 MHz spacing)		-33		dBc
Small Signal Gain Temperature Coefficient		-0.07		dB/°C
Output Power Temperature Coefficient				
- at $P_{IN} = 0\text{ dBm}$		-0.06		dBm/°C
- at $P_{IN} = 12\text{ dBm}$		-0.01		
Recommended Operating Voltage		20	22	V

Test conditions unless otherwise noted: 25 °C, $V_D = +20\text{ V}$, $I_{DQ} = 70\text{ mA}$, $V_G = -2.7\text{ V}$ Typical, CW.

Thermal and Reliability Information

Parameter	Test Conditions	Value	Units
Thermal Resistance (θ_{JC}) ⁽¹⁾	$T_{BASE} = 85^{\circ}\text{C}$, $V_D = 20\text{ V (CW)}$, $I_{DQ} = 70\text{ mA}$, $P_{DISS} = 1.4\text{ W}$	12.9	$^{\circ}\text{C/W}$
Channel Temperature (T_{CH}) (Quiescent)		103	$^{\circ}\text{C}$
Thermal Resistance (θ_{JC}) ⁽¹⁾	$T_{BASE} = 85^{\circ}\text{C}$, $V_D = 20\text{ V (CW)}$, Freq = 17 GHz, $I_{DQ} = 70\text{ mA}$, $P_{OUT} = 27\text{ dBm}$, $P_{DISS} = 3.2\text{ W}$	15.6	$^{\circ}\text{C/W}$
Channel Temperature (T_{CH}) (Under RF drive)		135	$^{\circ}\text{C}$
Thermal Resistance (θ_{JC}) ⁽¹⁾	$T_{BASE} = 85^{\circ}\text{C}$, $V_D = 20\text{ V (CW)}$, Freq = 17 GHz, $I_{DQ} = 70\text{ mA}$, $P_{OUT} = 33.5\text{ dBm}$, $P_{DISS} = 7.9\text{ W}$	14.8	$^{\circ}\text{C/W}$
Channel Temperature (T_{CH}) (Under RF drive)		202	$^{\circ}\text{C}$

Notes:

1. Thermal resistance measured to back of carrier plate. MMIC mounted on a 40 mil CuMo carrier using 1.5 mil 80/20 AuSn.
2. Refer to the following document: [GaN Device Channel Temperatures, Thermal Resistance, and Reliability Estimates.](#)

Power Dissipation

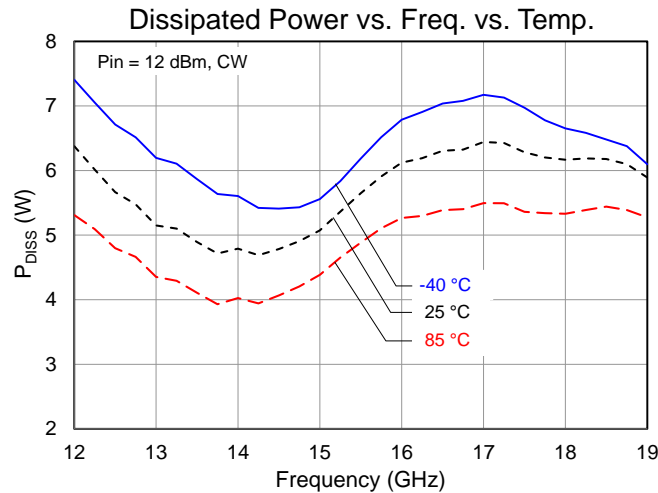

Performance Plots – Small Signal

Conditions unless otherwise specified: $V_D = +20\text{ V}$, $I_D = 70\text{ mA}$, $V_G = -2.7\text{ V}$ Typical, CW.

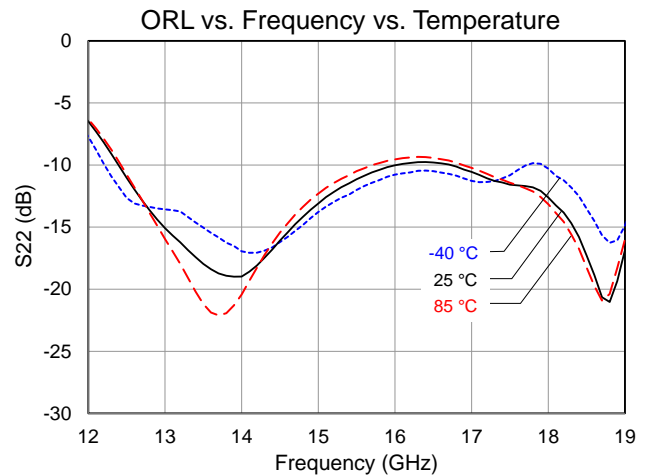
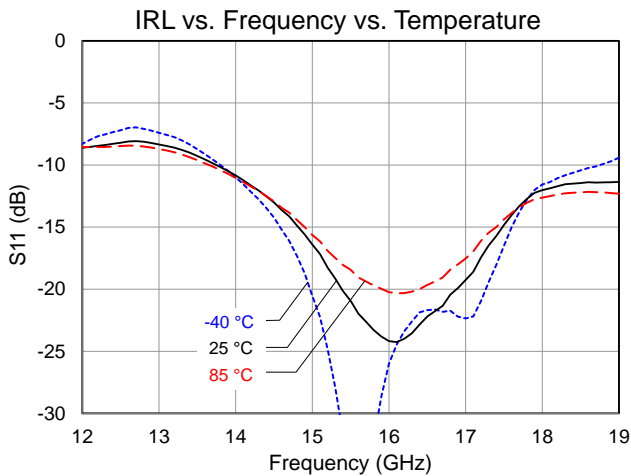
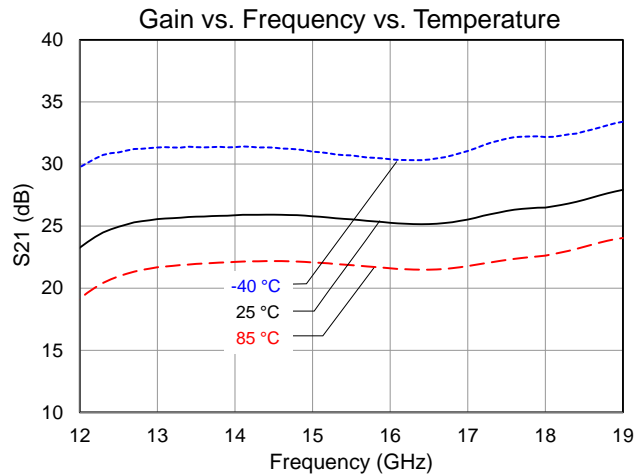
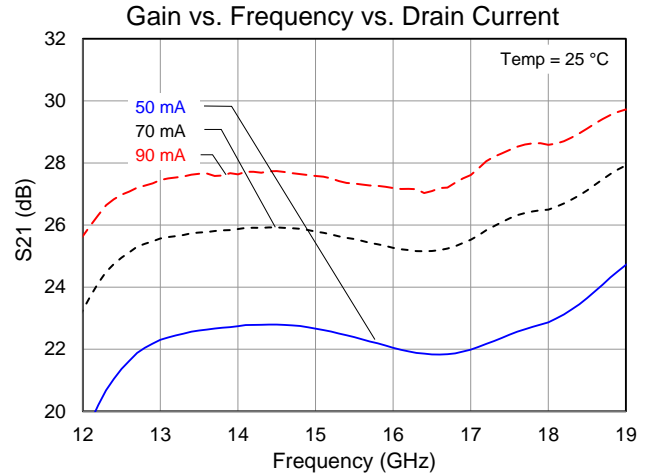
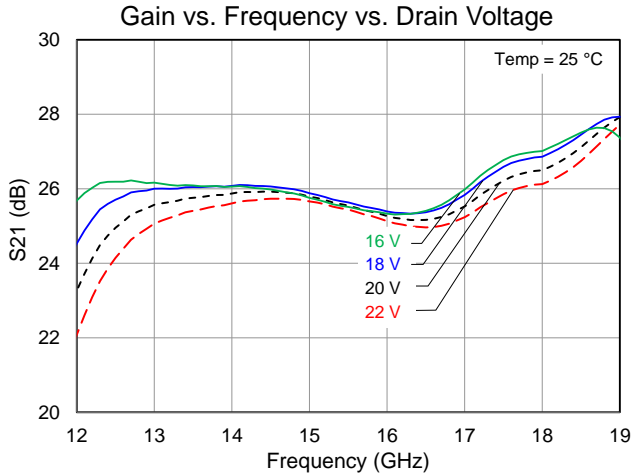

Performance Plots – Large Signal

Conditions unless otherwise specified: $V_D = +20\text{ V}$, $I_D = 70\text{ mA}$, $V_G = -2.7\text{ V}$ Typical, CW

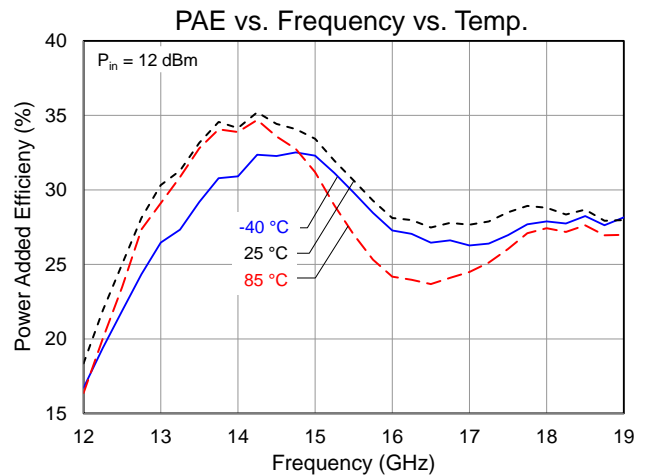
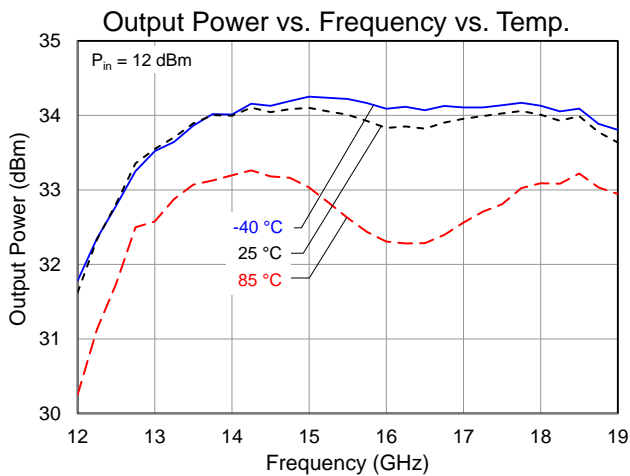
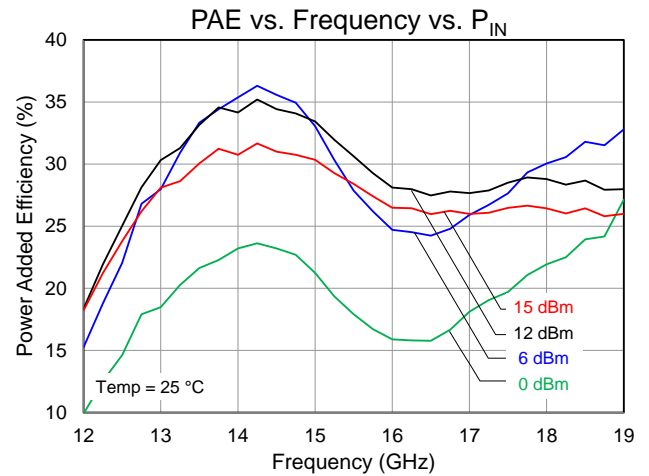
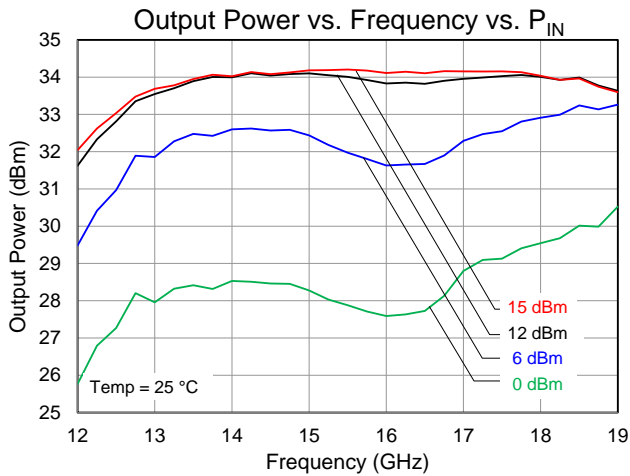
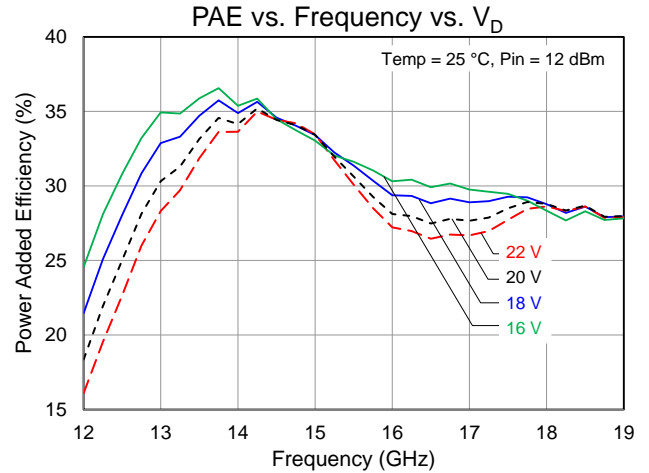
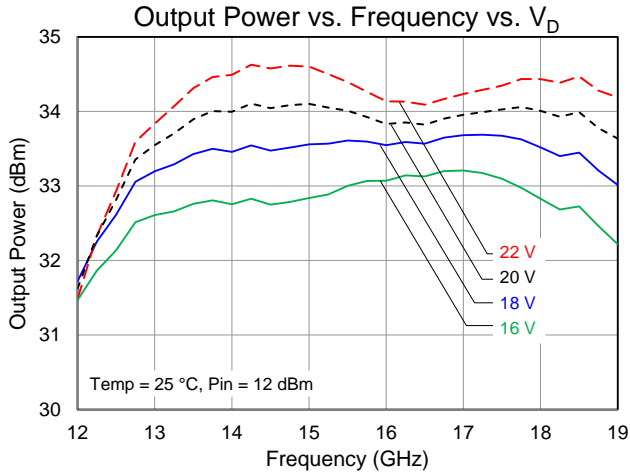

Performance Plots – Large Signal

Conditions unless otherwise specified: $V_D = +20\text{ V}$, $I_D = 70\text{ mA}$, $V_G = -2.7\text{ V}$ Typical, CW

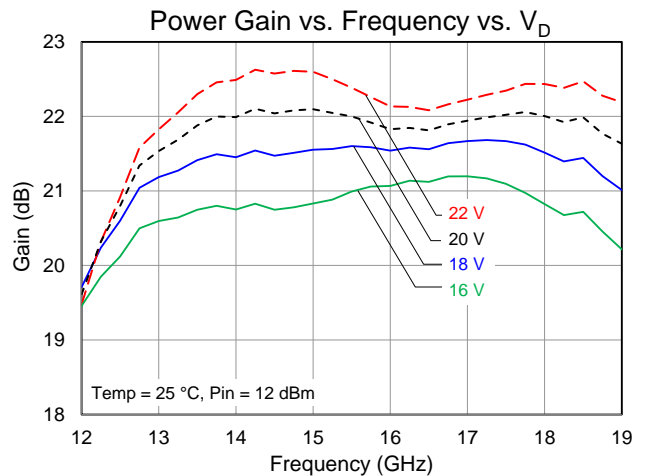
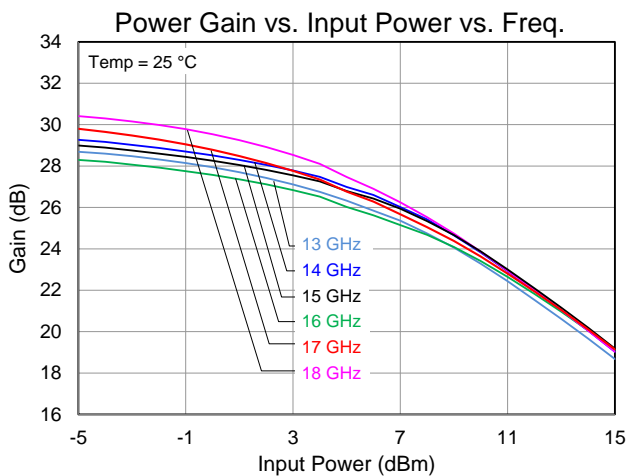
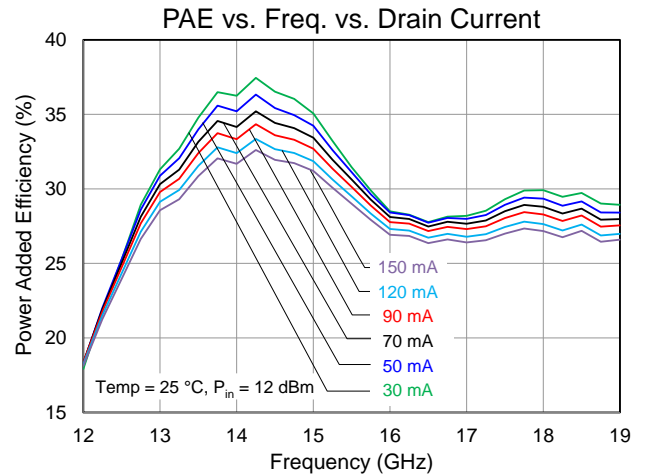
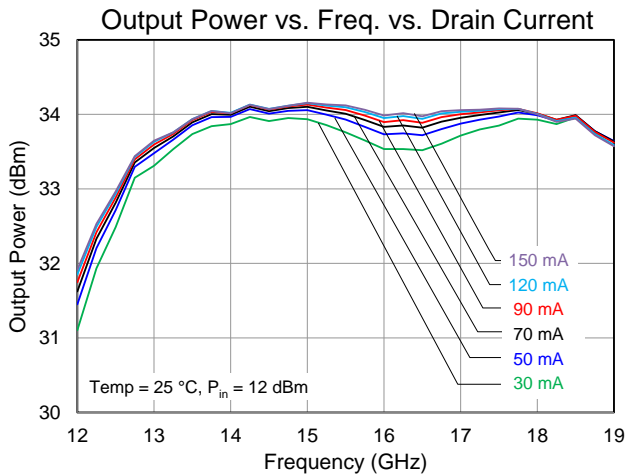
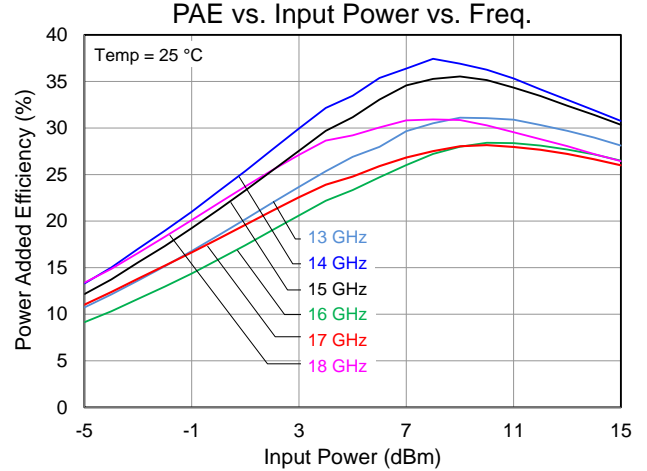
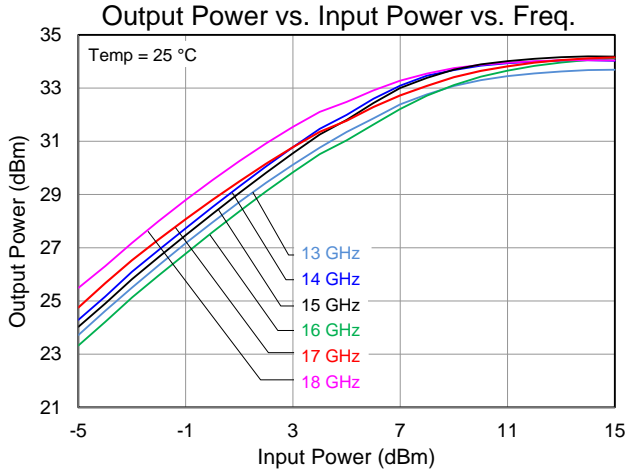

Performance Plots – Large Signal

Conditions unless otherwise specified: $V_D = +20\text{ V}$, $I_D = 70\text{ mA}$, $V_G = -2.7\text{ V}$ Typical, CW

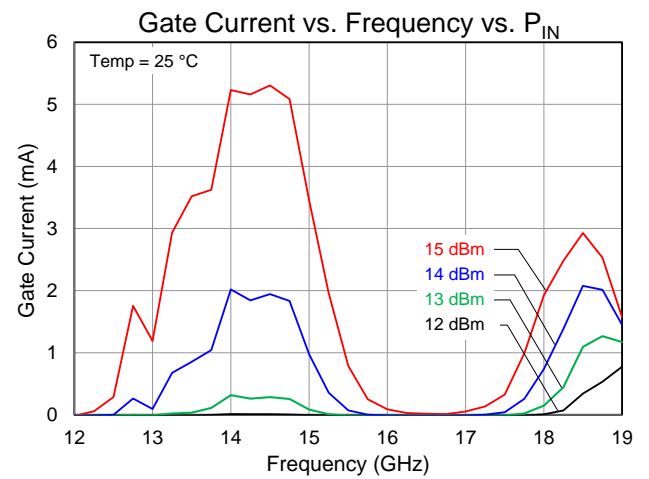
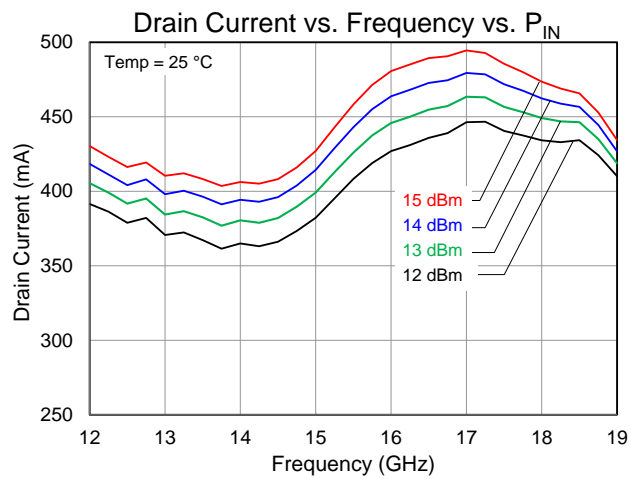
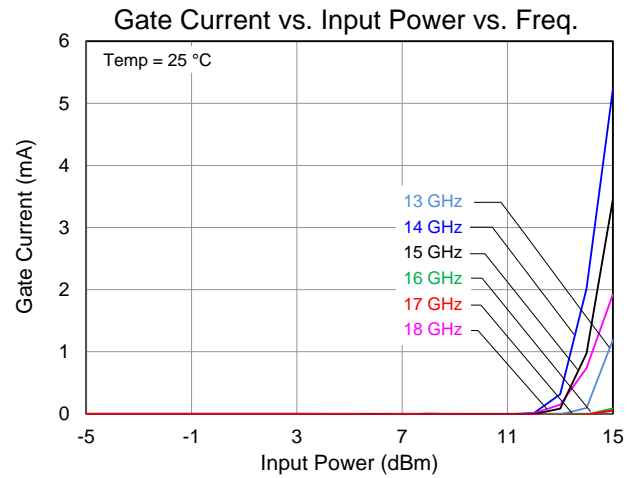
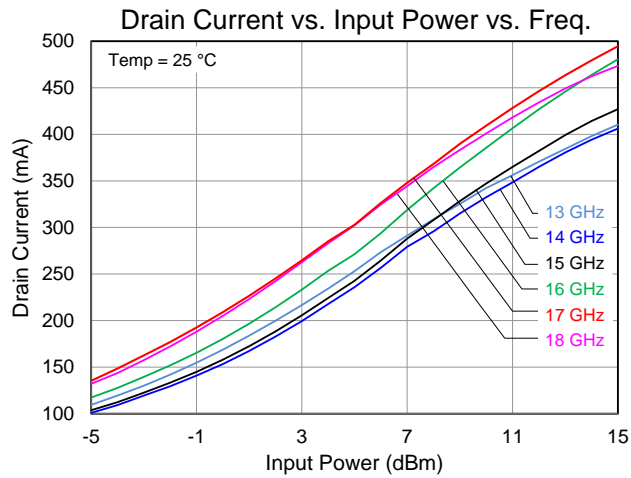
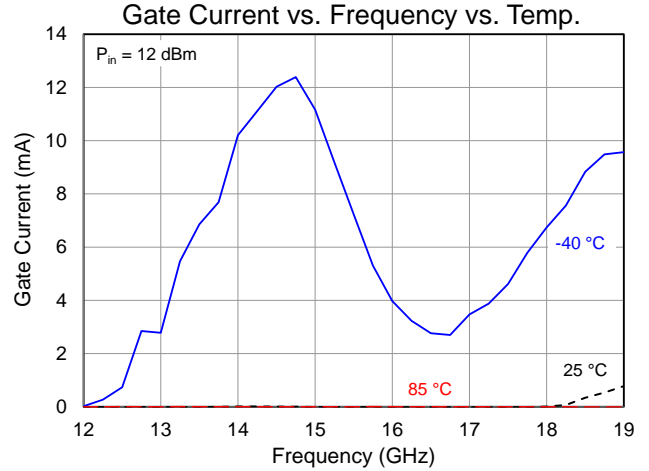
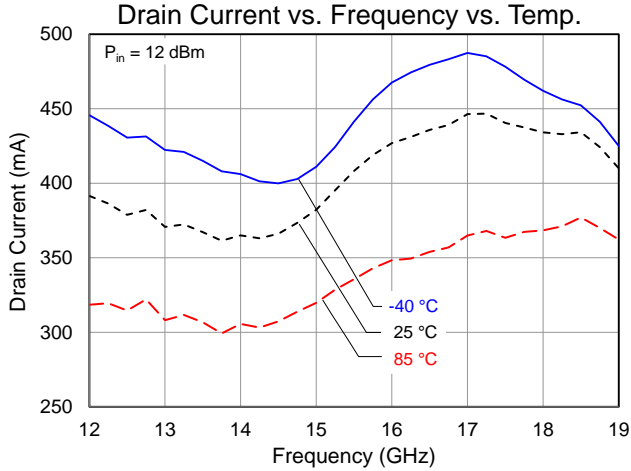

Performance Plots – Large Signal and Linearity

Conditions unless otherwise specified: $V_D = +20\text{ V}$, $I_D = 70\text{ mA}$, $V_G = -2.7\text{ V}$ Typical, CW

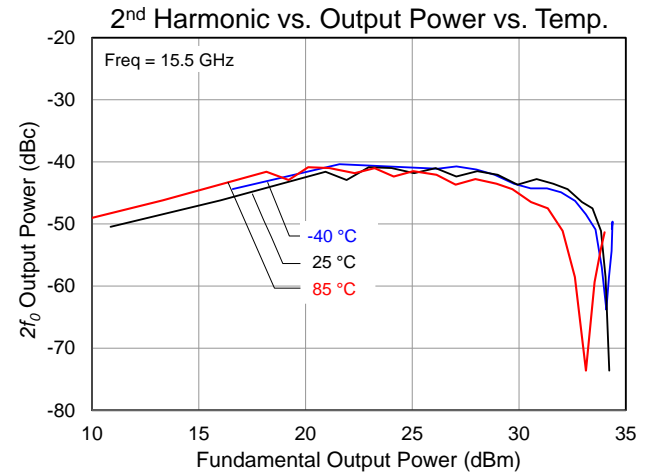
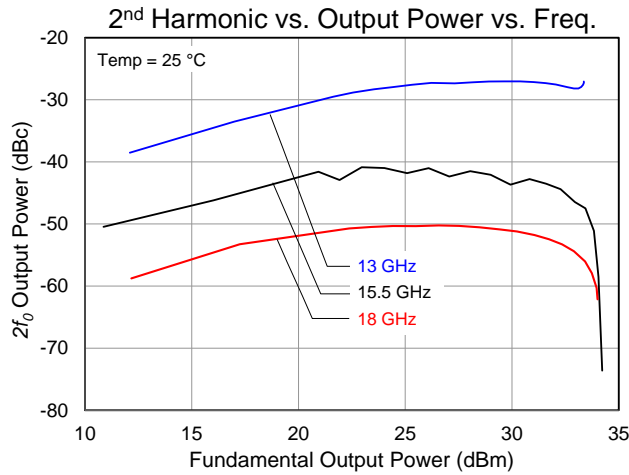
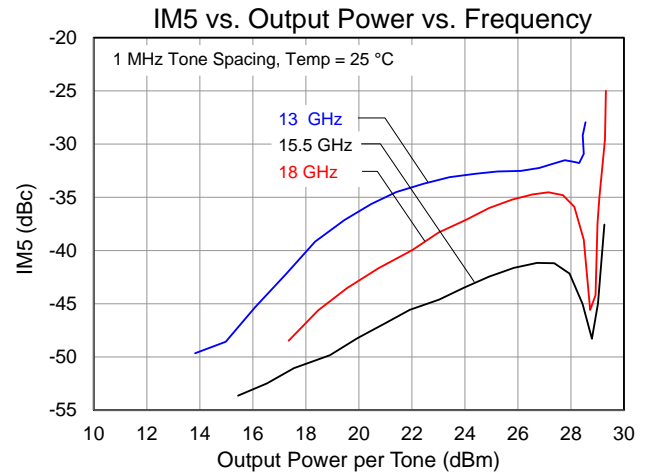
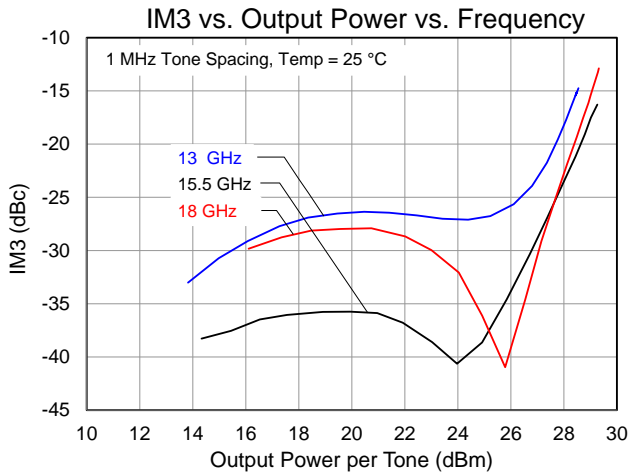

Applications Information and Pad Layout

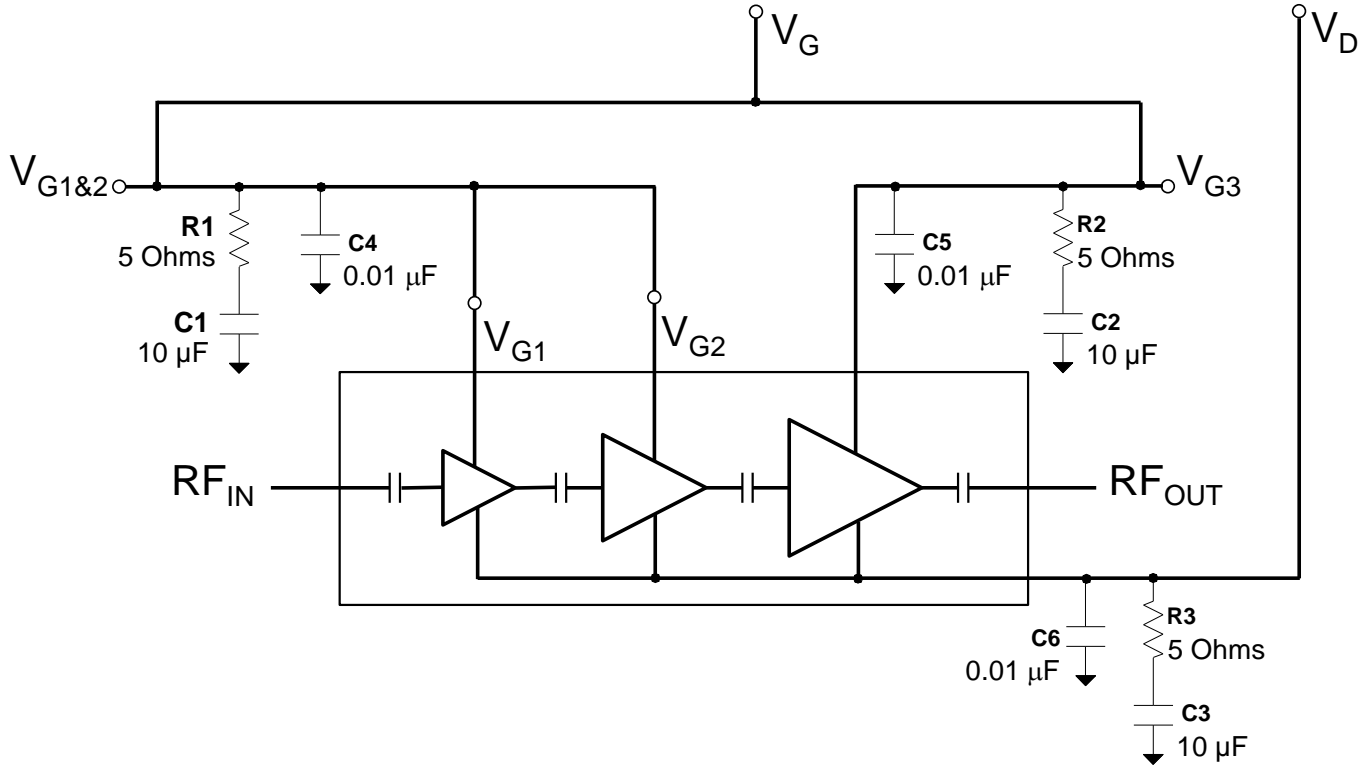

Bias Up Procedure

1. Set I_D limit to 500 mA, I_G limit to 13 mA
2. Apply -5 V to V_G
3. Apply +20 V to V_D ; ensure I_{DQ} is approx. 0 mA
4. Adjust V_G until $I_{DQ} = 70$ mA ($V_G \sim -2.7$ V Typ.).
5. Turn on RF signal generator

Bias Down Procedure

1. Turn off RF signal generator
2. Reduce V_G to -5 V; ensure I_{DQ} is approx. 0 mA
3. Set V_D to 0 V
4. Turn off V_D supply
5. Turn off V_G supply

Evaluation Board

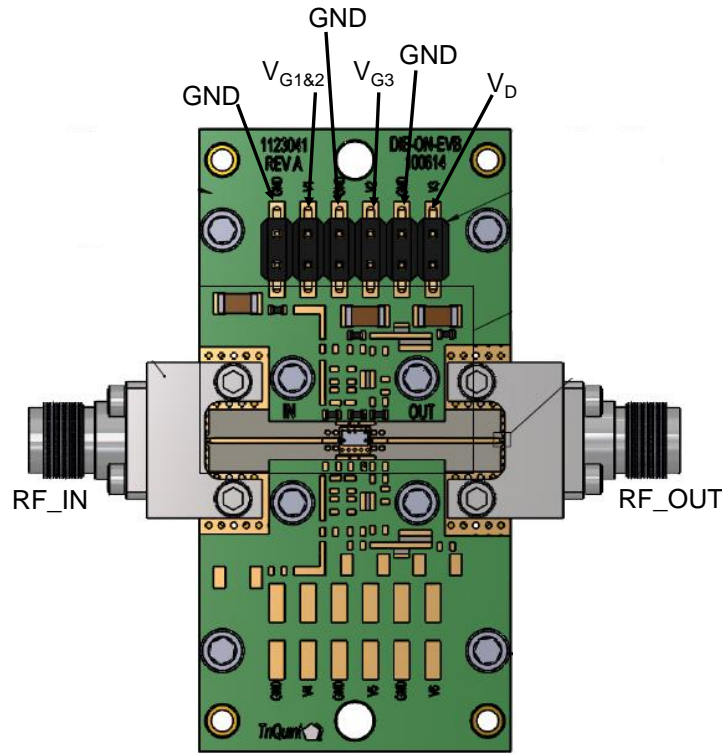

MMIC Bonding Detail:

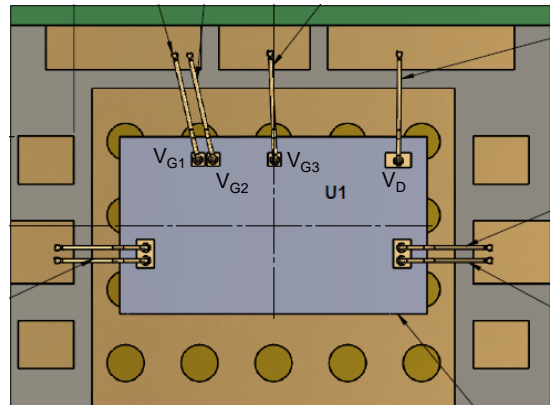
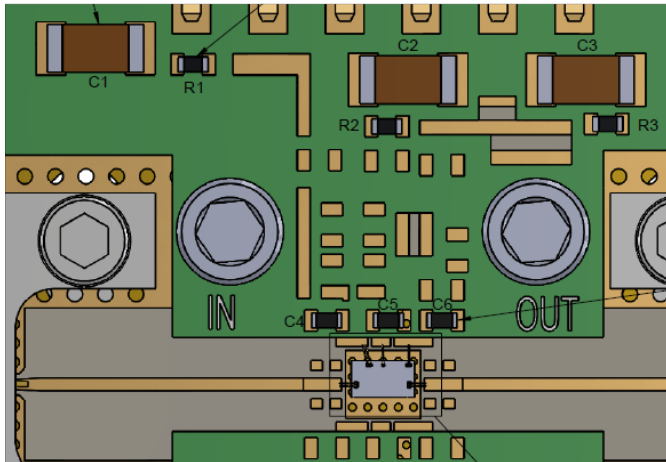

Bill of Materials

Reference Des.	Value	Description	Manuf.	Part Number
C1, C2, C3	10 μ F	Cap, 1206, 50V, 20%, X5R	Various	–
C4, C5, C6	0.01 μ F	Cap, 0402, 50V, 10%, X7R	Various	–
R1, R2, R3	5.1 Ohms	Res, 0402, 5%	Various	–

Mechanical Information

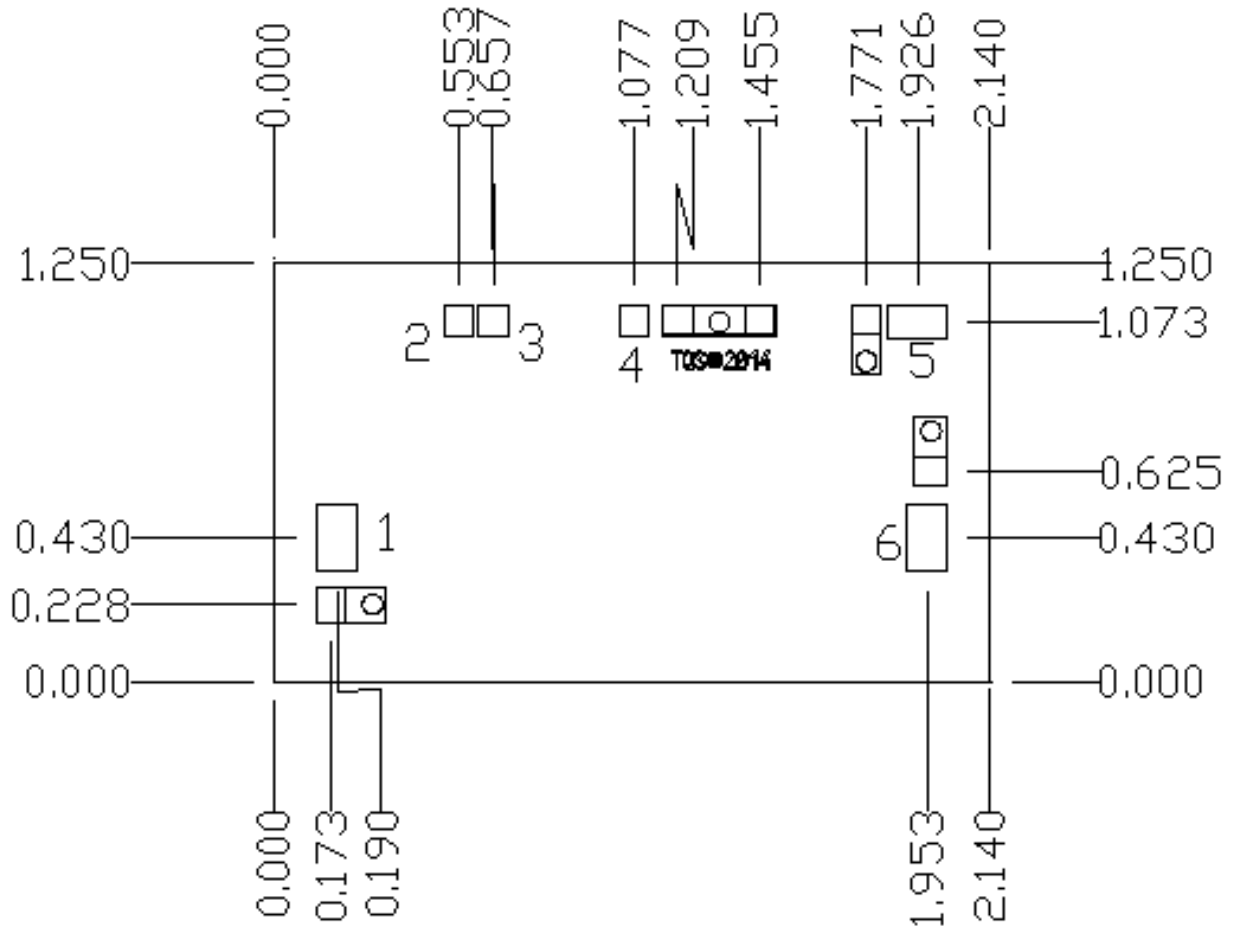

Pad Description

Pad No.	Symbol	Description
1	RF _{IN}	Input; matched to 50 Ω; DC blocked
2	V _{G1} (1), (2)	Gate Voltage; Bias network is required; see recommended Application Information on page 9.
3	V _{G2} (1), (2)	Gate Voltage; Bias network is required; see recommended Application Information on page 9.
4	V _{G3} (2)	Gate Voltage; Bias network is required; see recommended Application Information on page 9.
5	V _D	Drain voltage; Bias network is required; see recommended Application Information page 9.
6	RF _{OUT}	Output; matched to 50 Ω; DC blocked

Notes:

1. Pads 2 & 3 are tied together off-chip.
2. Pads 2,3, & 4 may be tied together for biasing

Assembly Notes

Component placement and adhesive attachment assembly notes:

- Vacuum pencils and/or vacuum collets are the preferred method of pick up.
- Air bridges must be avoided during placement.
- The force impact is critical during auto placement.

Reflow process assembly notes:

- Use AuSn (80/20) solder and limit exposure to temperatures above 300°C to 3-4 minutes, maximum.
- An alloy station or conveyor furnace with reducing atmosphere should be used.
- Do not use any kind of flux.
- Coefficient of thermal expansion matching is critical for long-term reliability.
- Devices must be stored in a dry nitrogen atmosphere.

Interconnect process assembly notes:

- Thermosonic ball bonding is the preferred interconnect technique.
- Force, time, and ultrasonic are critical parameters.
- Aluminum wire should not be used.
- Devices with small pad sizes should be bonded with 0.0007-inch wire.

Handling Precautions

Parameter	Rating	Standard		Caution! ESD-Sensitive Device
ESD – Human Body Model (HBM)	TBD	JEDEC Standard JESD22 A114		

Solderability

Use only AuSn (80/20) solder, and limit exposure to temperatures above 300 °C to 3–4 minutes, maximum.

RoHS Compliance

This product is compliant with the 2011/65/EU RoHS directive (Restrictions on the Use of Certain Hazardous Substances in Electrical and Electronic Equipment), as amended by Directive 2015/863/EU. This product also has the following attributes:

- Lead Free
- Halogen Free (Chlorine, Bromine)
- Antimony Free
- TBBP-A (C₁₅H₁₂Br₄O₂) Free
- PFOS Free
- SVHC Free

Contact Information

For the latest specifications, additional product information, worldwide sales and distribution locations:

Web: www.qorvo.com

Tel: 1-844-890-8163

Email: customer.support@qorvo.com

Important Notice

The information contained herein is believed to be reliable; however, Qorvo makes no warranties regarding the information contained herein and assumes no responsibility or liability whatsoever for the use of the information contained herein. All information contained herein is subject to change without notice. Customers should obtain and verify the latest relevant information before placing orders for Qorvo products. The information contained herein or any use of such information does not grant, explicitly or implicitly, to any party any patent rights, licenses, or any other intellectual property rights, whether with regard to such information itself or anything described by such information. **THIS INFORMATION DOES NOT CONSTITUTE A WARRANTY WITH RESPECT TO THE PRODUCTS DESCRIBED HEREIN, AND QORVO HEREBY DISCLAIMS ANY AND ALL WARRANTIES WITH RESPECT TO SUCH PRODUCTS WHETHER EXPRESS OR IMPLIED BY LAW, COURSE OF DEALING, COURSE OF PERFORMANCE, USAGE OF TRADE OR OTHERWISE, INCLUDING THE IMPLIED WARRANTIES OF MERCHANTABILITY AND FITNESS FOR A PARTICULAR PURPOSE.**

Without limiting the generality of the foregoing, Qorvo products are not warranted or authorized for use as critical components in medical, life-saving, or life-sustaining applications, or other applications where a failure would reasonably be expected to cause severe personal injury or death.

Copyright 2021 © Qorvo, Inc. | Qorvo is a registered trademark of Qorvo, Inc.

X-ON Electronics

Largest Supplier of Electrical and Electronic Components

Click to view similar products for [RF Amplifier](#) category:

Click to view products by [Qorvo](#) manufacturer:

Other Similar products are found below :

[A82-1](#) [BGA622H6820XTSA1](#) [BGA 728L7 E6327](#) [BGB719N7ESDE6327XTMA1](#) [HMC397-SX](#) [HMC405](#) [HMC561-SX](#) [HMC8120-SX](#)
[HMC8121-SX](#) [HMC-ALH382-SX](#) [HMC-ALH476-SX](#) [SE2433T-R](#) [SMA3101-TL-E](#) [SMA39](#) [A66-1](#) [A66-3](#) [A67-1](#) [LX5535LQ](#) [LX5540LL](#)
[MAAM02350](#) [HMC3653LP3BETR](#) [HMC549MS8GETR](#) [HMC-ALH435-SX](#) [SMA101](#) [SMA32](#) [SMA411](#) [SMA531](#) [SST12LP19E-QX6E](#)
[WPM0510A](#) [HMC5929LS6TR](#) [HMC5879LS7TR](#) [HMC1126](#) [HMC1087F10](#) [HMC1086](#) [HMC1016](#) [SMA1212](#) [MAX2689EWS+T](#)
[MAAMSS0041TR](#) [MAAM37000-A1G](#) [LTC6430AIUF-15#PBF](#) [SMA70-2](#) [SMA4011](#) [A231](#) [HMC-AUH232](#) [LX5511LQ](#) [LX5511LQ-TR](#)
[HMC7441-SX](#) [HMC-ALH310](#) [XD1001-BD-000V](#) [A4011](#)