

Product Description

The TGA2958-SM is a packaged Ku-band amplifier fabricated on Qorvo’s 0.15 um GaN on SiC production process (QGaN15). Operating over a 13–18 GHz bandwidth, the TGA2958-SM delivers 2W of saturated output power with 20 dB large signal gain and > 25 % power-added efficiency. This, along with >25 dB small signal gain allows it to support a variety of low power Ku-band systems or as a linear, high-voltage driver for Qorvo’s line of high power Ku-band amplifiers.

Packaged in a 4 x 4 air-cavity package for high performance and easy handling, the TGA2958-SM is fully matched to 50 ohms with integrated DC blocking capacitors on both I/O ports for simple system integration. This makes for an ideal general purpose RF amplifier which can provide needed functionality across both commercial and defense related markets.

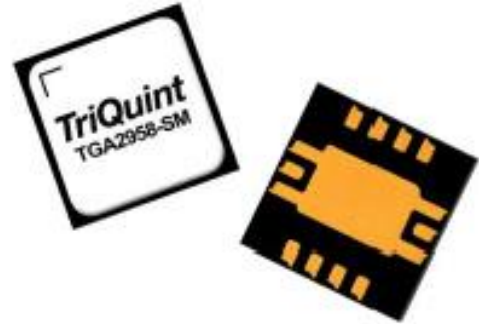

14 Lead 4 x 4 Air Cavity Laminate Package

Product Features

- Frequency Range: 13 – 18 GHz
- P_{SAT}: 33 dBm at P_{IN} = 13 dBm
- PAE: 25 % at P_{IN} = 13 dBm
- Small Signal Gain: 25 dB
- Input Return Loss: > 7 dB
- Output Return Loss: > 13 dB
- Bias: V_D = +20 V, I_{DQ} = 70 mA, V_G = -2.7 V Typical
- Package Dimensions: 4.0 x 4.0 x 1.74 mm
- Performance under CW operation

Performance is typical across frequency. Please reference electrical specification table and data plots for more details.

Functional Block Diagram

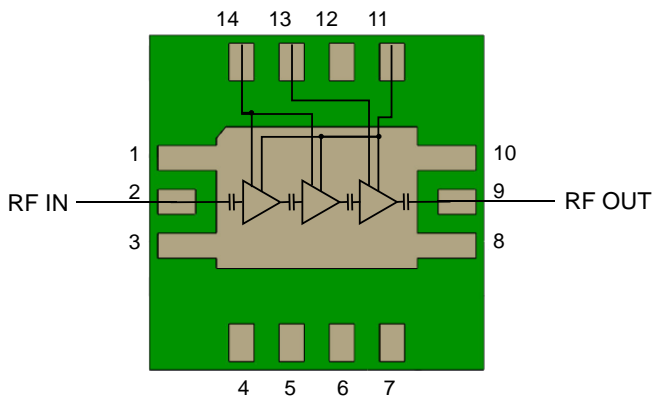

Applications

- Satellite Communications
- Data Links
- Radar
- General Purpose

Ordering Information

Part No.	Description
TGA2958-SM	13 – 18 GHz 2 W GaN Driver Amplifier
TGA2958-SM EVB	Evaluation Board

Electrical Specifications

Parameter	Freq. (GHz)	Min	Typ	Max	Units
Operational Frequency Range		13	–	18	GHz
Small Signal Gain			25		dB
Input Return Loss			> 7		dB
Output Return Loss			> 13		dB
Output Power at P _{IN} = 13 dBm	13	31	32.5		dBm
	14, 15, 16, 17	32.5	34		
	18	31.5	33		
Power Added Efficiency at P _{IN} = 13 dBm	13	16	22		%
	14, 15, 16, 17	19	28		
	18	17	23		
Large Signal Gain at P _{IN} = 13 dBm			> 20		dB
IM3 (P _{out} /tone = 24 dBm, 1 MHz spacing)			-31		dBc
IM5 (P _{out} /tone = 24 dBm, 1 MHz spacing)			-46		dBc
Gate Leakage (V _D = 10 V, V _G = -3.7 V), I _g	n/a	-1.4		1.4	mA
Small Signal Gain Temperature Coefficient			-0.07		dB/°C
Output Power Temperature Coefficient					dB/°C
- at P _{IN} = 0 dBm			-0.04		
- at P _{IN} = 12 dBm			-0.01		

Test conditions unless otherwise noted: 25 °C, V_D = +20 V, I_{DQ} = 70 mA, V_G = -2.7 V Typ, CW

Recommended Operating Conditions

Parameter	Value / Range
Drain Voltage (V _D) CW	20 - 22 V
Drain Current (I _{DQ})	70 mA
Drain Current Under RF Drive (I _{D_DRIVE})	See plots p. 6
Gate Voltage Range, Typical (V _G)	-2.0 to -3.2 V
Gate Current Under RF Drive (I _{G_DRIVE})	See plots p. 6
Temperature (T _{BASE})	-40 to 85 °C

Electrical specifications are measured at specified test conditions. Specifications are not guaranteed over all recommended operating conditions.

Typical Performance – Small Signal

Conditions unless otherwise specified: $V_D = +20\text{ V}$, $I_{DQ} = 70\text{ mA}$, $V_G = -2.7\text{ V Typ}$, CW

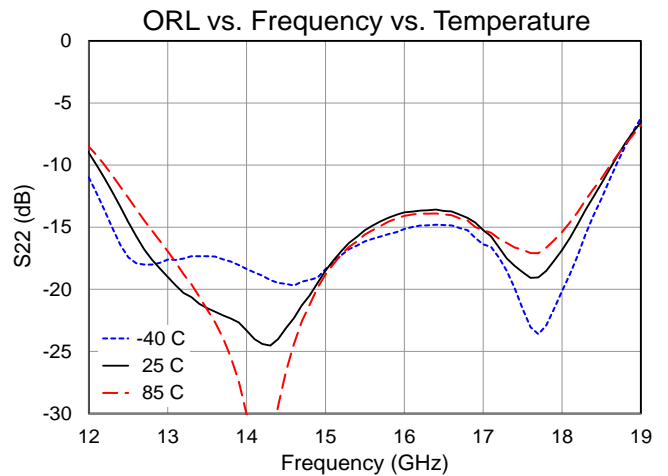
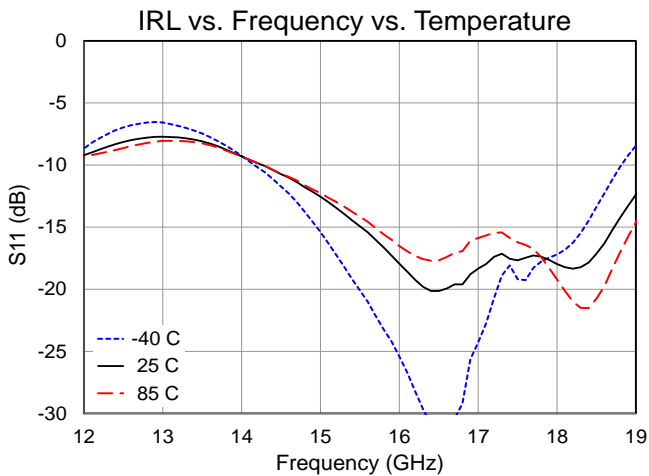
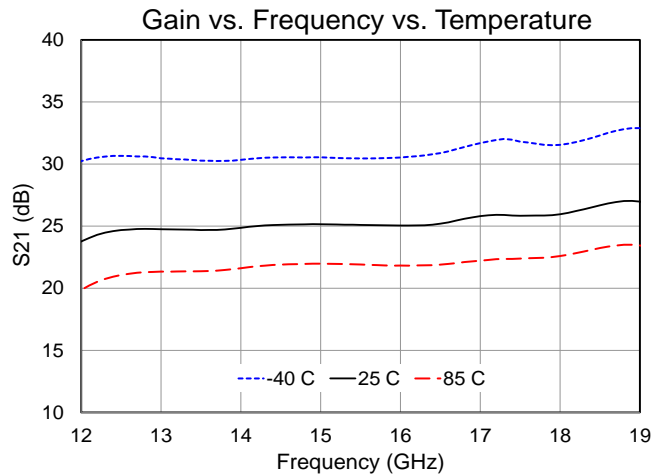
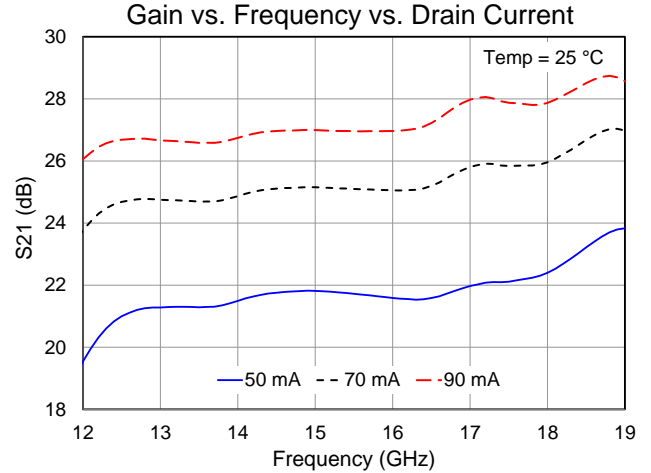
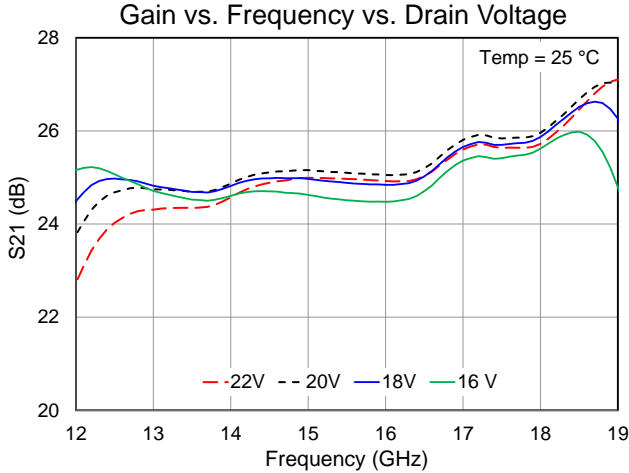

Performance Plots – Large Signal

Conditions unless otherwise specified: $V_D = +20\text{ V}$, $I_{DQ} = 70\text{ mA}$, $V_G = -2.7\text{ V Typ}$, CW

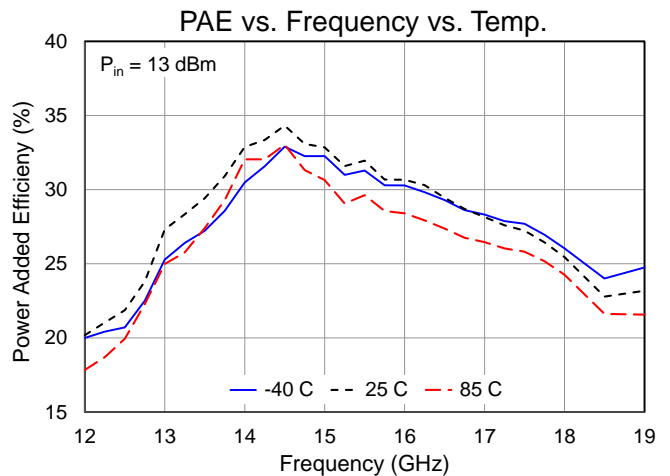
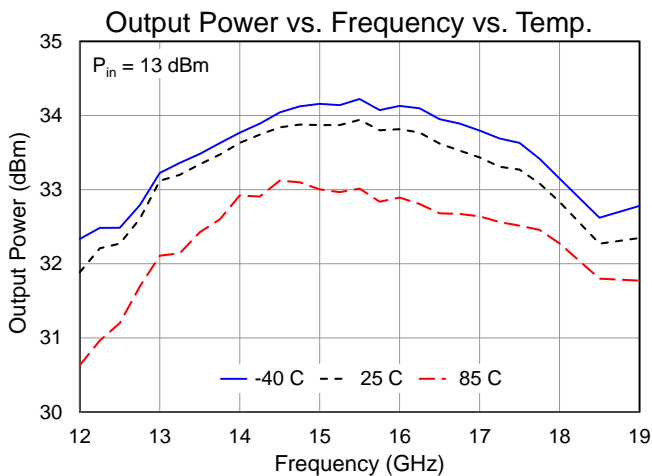
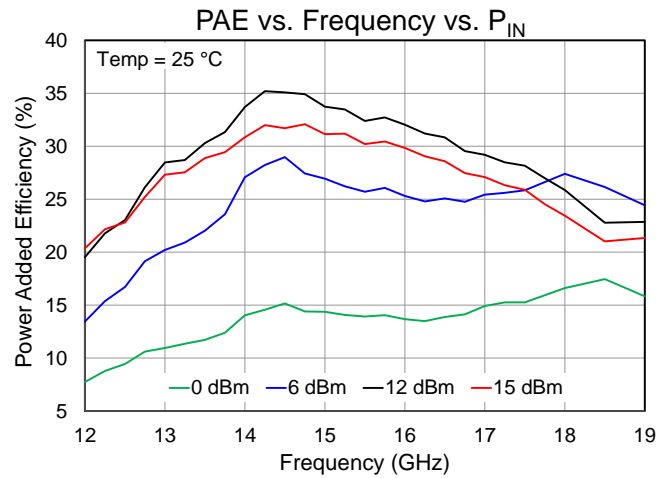
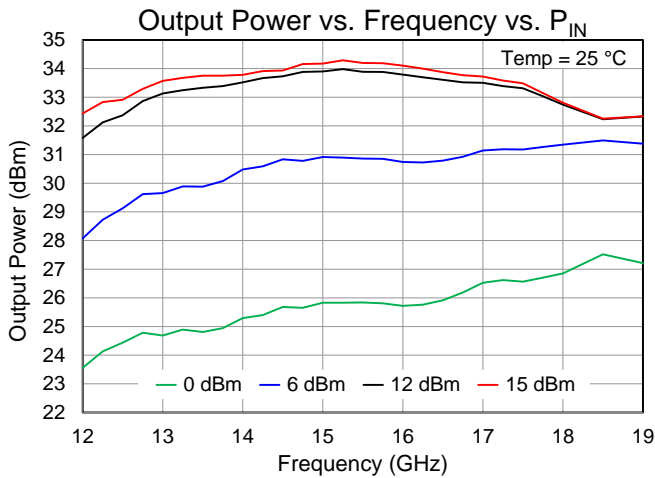
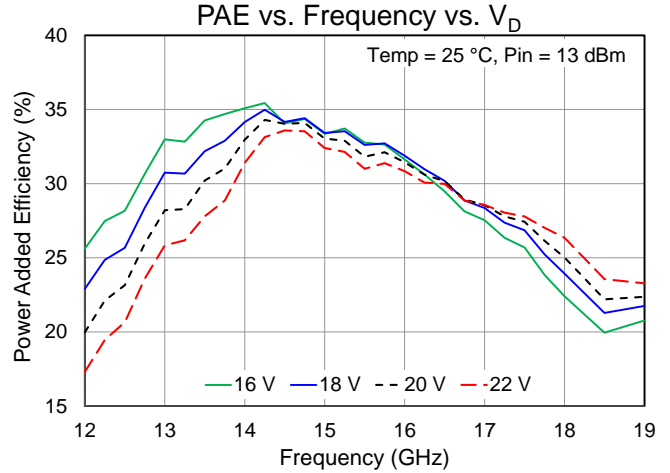
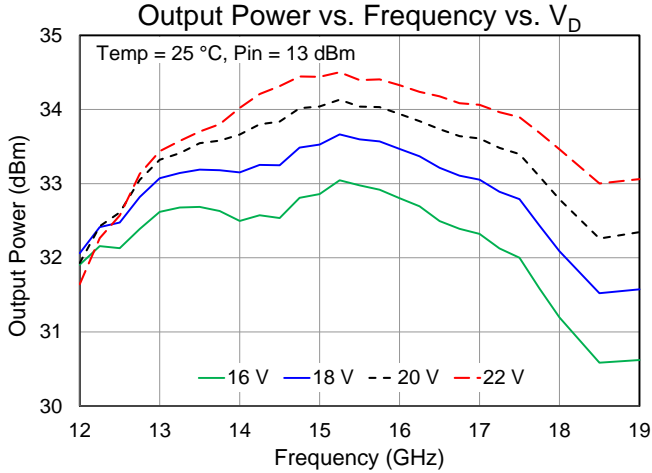

Typical Performance – Large Signal

Conditions unless otherwise specified: $V_D = +20\text{ V}$, $I_{DQ} = 70\text{ mA}$, $V_G = -2.7\text{ V Typ}$, CW

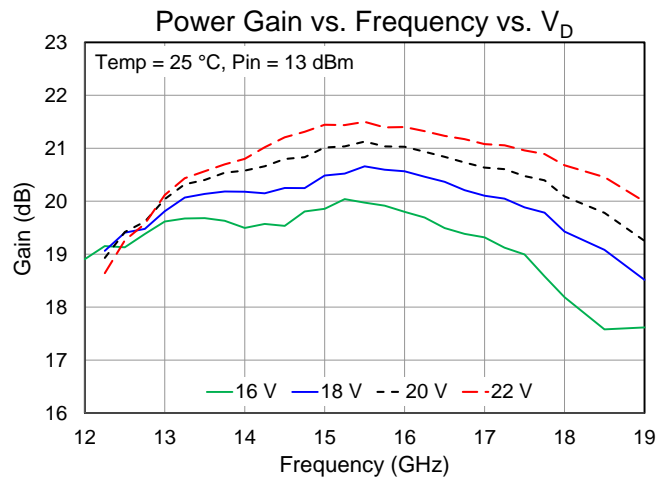
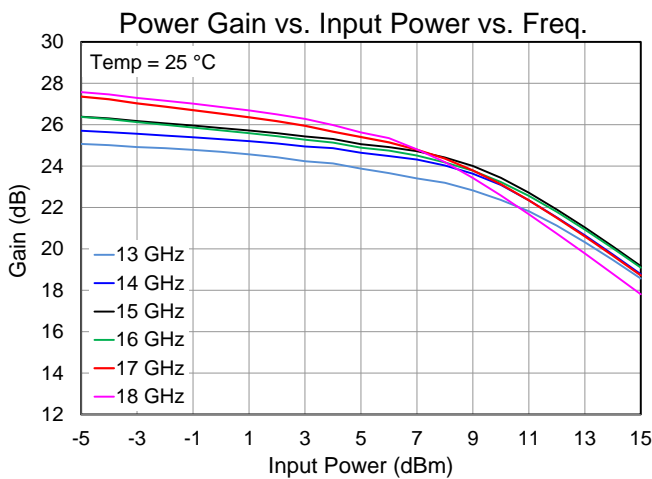
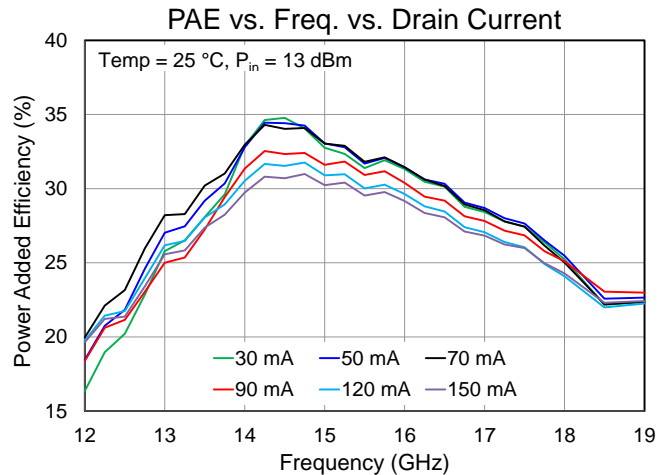
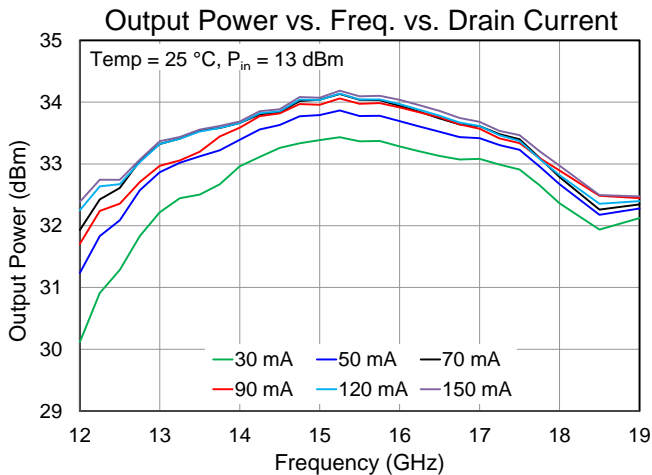
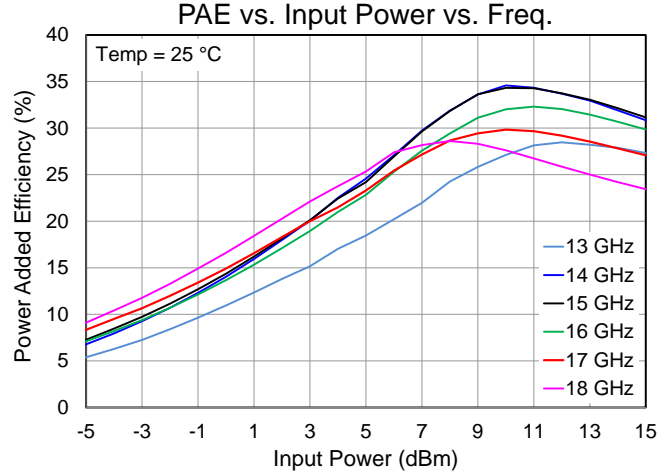
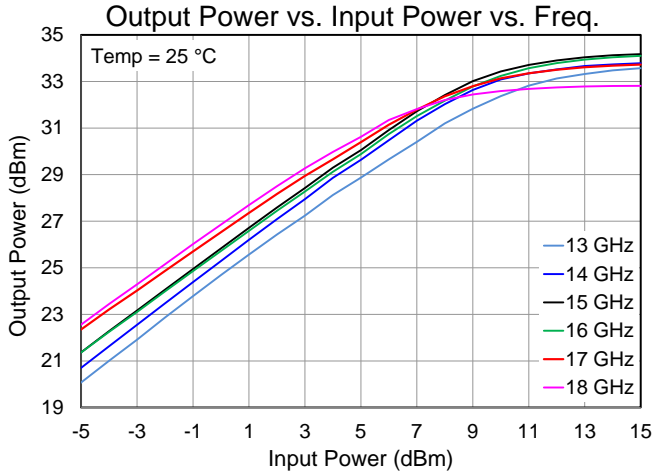

Typical Performance – Large Signal

Conditions unless otherwise specified: $V_D = +20\text{ V}$, $I_{DQ} = 70\text{ mA}$, $V_G = -2.7\text{ V Typ}$, CW

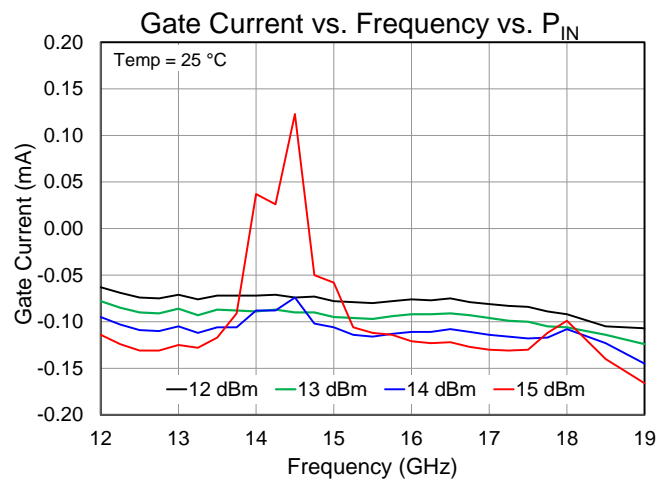
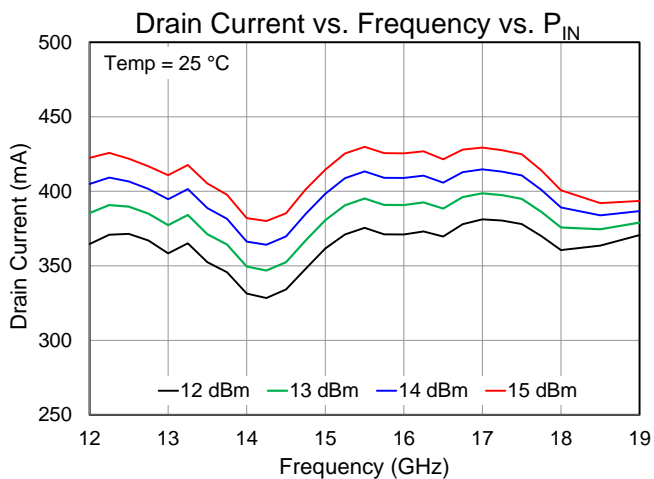
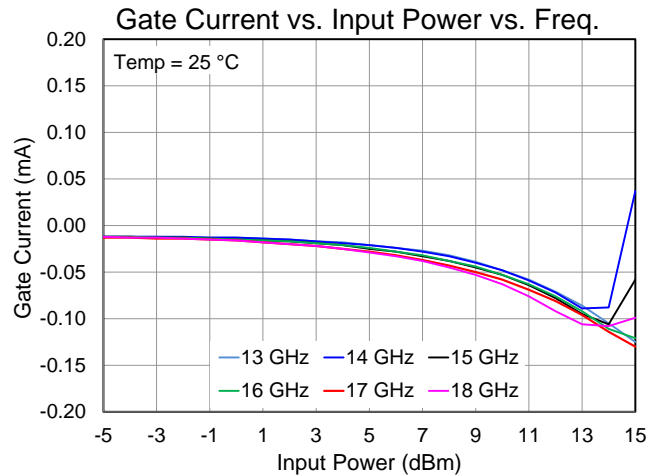
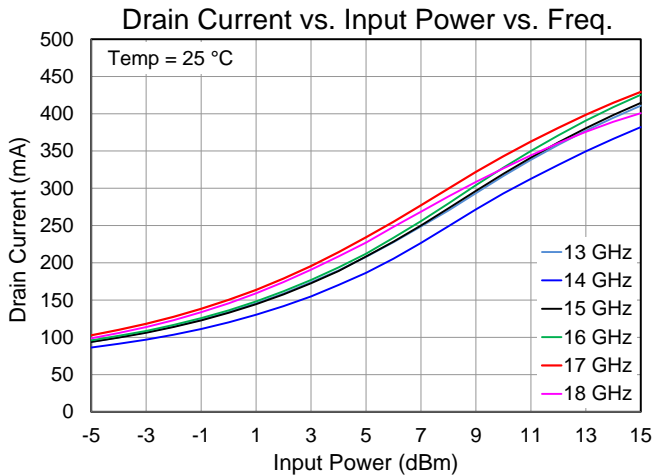
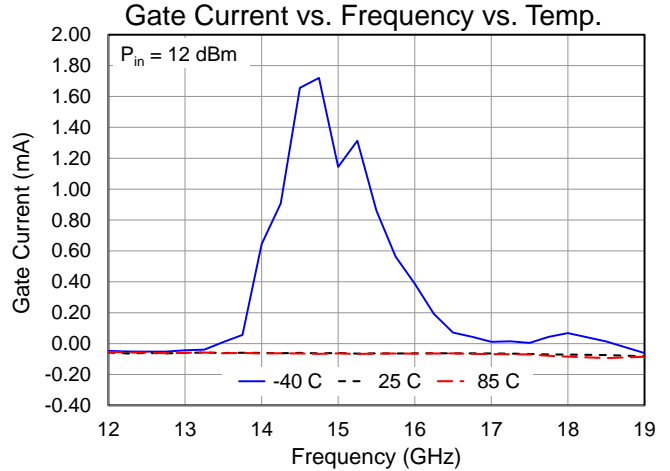
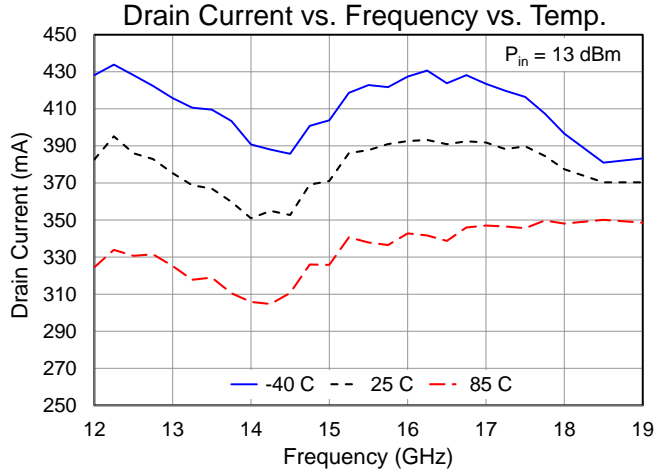

Typical Performance – Linearity

Conditions unless otherwise specified: $V_D = +20\text{ V}$, $I_{DQ} = 70\text{ mA}$, $V_G = -2.7\text{ V Typ}$, CW; harmonic data from die version

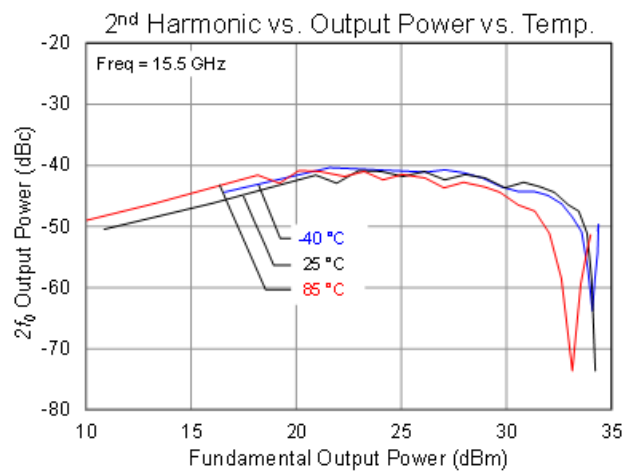
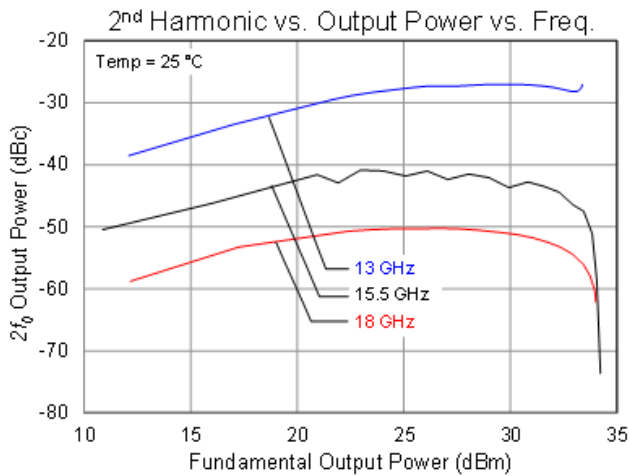
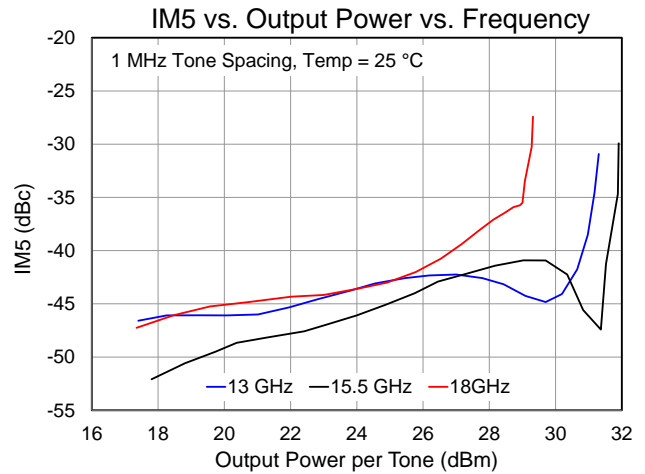
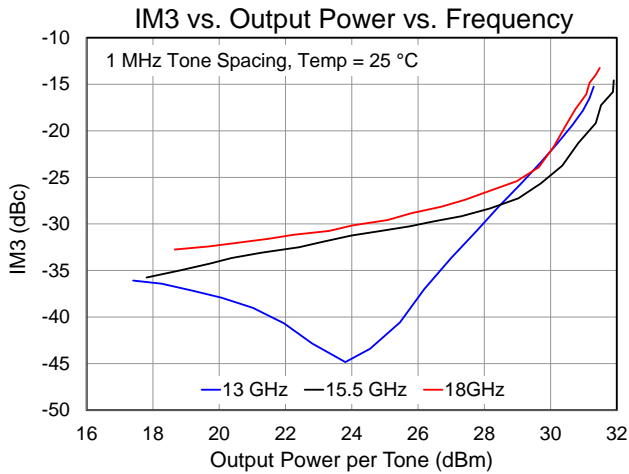

Thermal and Reliability Information

Parameter	Test Conditions	Value	Units
Thermal Resistance (θ_{JC}) ⁽¹⁾	$T_{BASE} = 85\text{ }^{\circ}\text{C}$, $V_D = +20\text{ V}$ (CW) At $I_{DQ} = 70\text{ mA}$, $P_{DISS} = 1.4\text{ W}$	7.14	$^{\circ}\text{C/W}$
Channel Temperature (T_{CH}) (No RF) ⁽²⁾		95	$^{\circ}\text{C}$
Thermal Resistance (θ_{JC}) ⁽¹⁾	$T_{BASE} = 85\text{ }^{\circ}\text{C}$, $V_D = +20\text{ V}$ (CW) At Freq = 17 GHz, $I_{DQ} = 70\text{ mA}$, $P_{OUT} = 27\text{ dBm}$, $P_{DISS} = 2.6\text{ W}$	9.62	$^{\circ}\text{C/W}$
Channel Temperature (T_{CH}) (Under RF drive) ⁽²⁾		110	$^{\circ}\text{C}$
Thermal Resistance (θ_{JC}) ⁽¹⁾	$T_{BASE} = 85\text{ }^{\circ}\text{C}$, $V_D = +20\text{ V}$ (CW) At Freq = 17 GHz, $I_{DQ} = 70\text{ mA}$, $P_{OUT} = 33.5\text{ dBm}$, $P_{DISS} = 5.3\text{ W}$	10.0	$^{\circ}\text{C/W}$
Channel Temperature (T_{CH}) (Under RF drive) ⁽²⁾		138	$^{\circ}\text{C}$

Notes:

- Thermal resistance is referenced to the package backside T_{BASE}
- IR scan equivalent. Refer to the following document: [GaN Device Channel Temperature, Thermal Resistance, and Reliability Estimates](#)

Power Dissipation and Maximum Gate Current

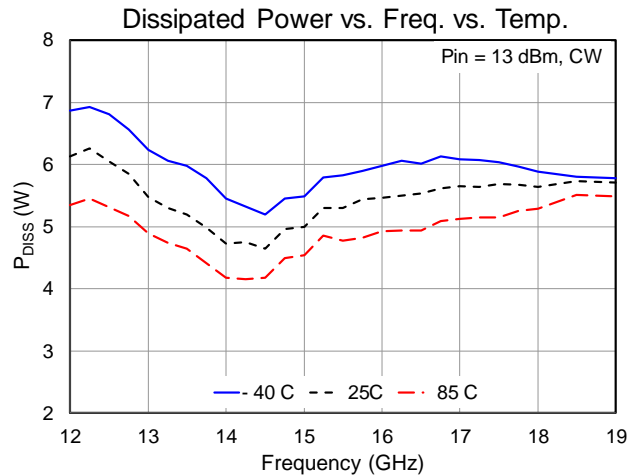
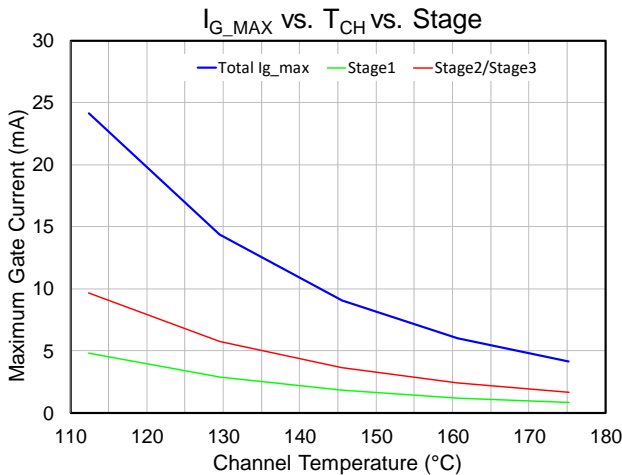

Application Circuit

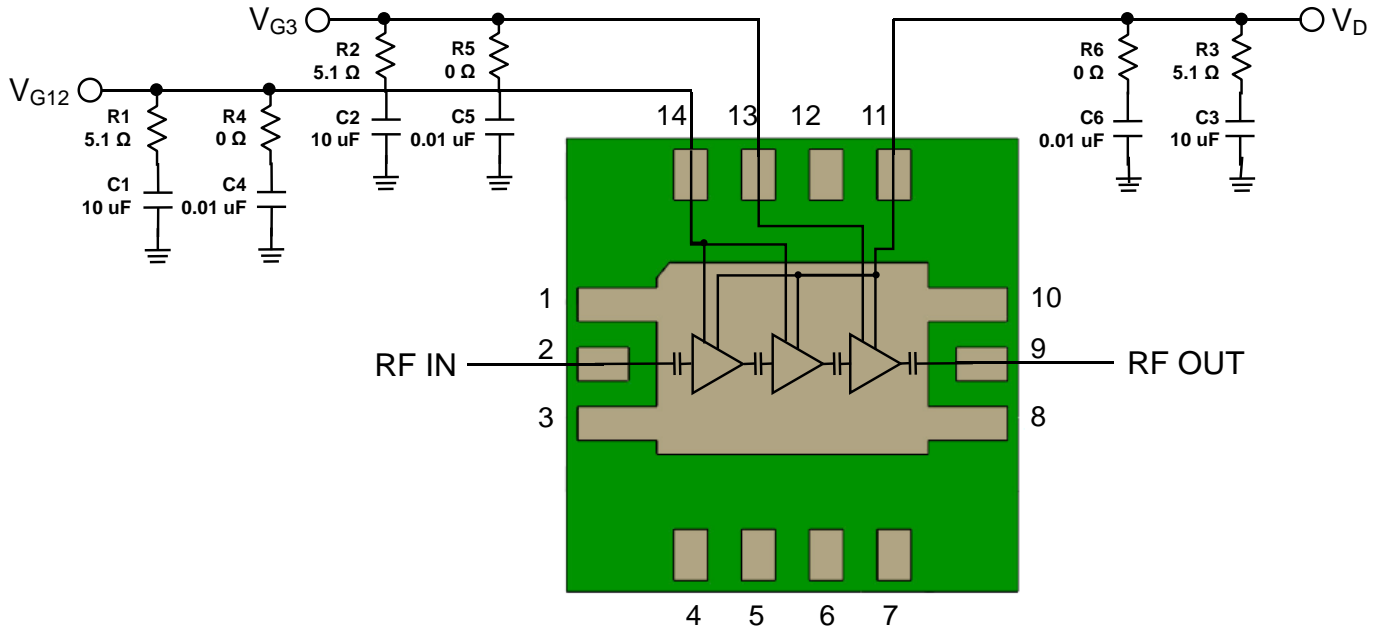

Bias Up Procedure

1. Set I_D limit to 500 A, I_G limit to 13 mA
2. Apply -5 V to V_G
3. Apply $+20\text{ V}$ to V_D ; ensure I_{DQ} is approx. 0 mA
4. Adjust V_G until $I_{DQ} = 70\text{ mA}$ ($V_G \sim -2.7\text{ V Typ.}$).
5. Turn on RF signal generator

Bias Down Procedure

1. Turn off RF signal generator
2. Reduce V_G to -5 V ; ensure I_{DQ} is approx. 0 mA
3. Set V_D to 0 V
4. Turn off V_D supply
5. Turn off V_G supply

Evaluation Board

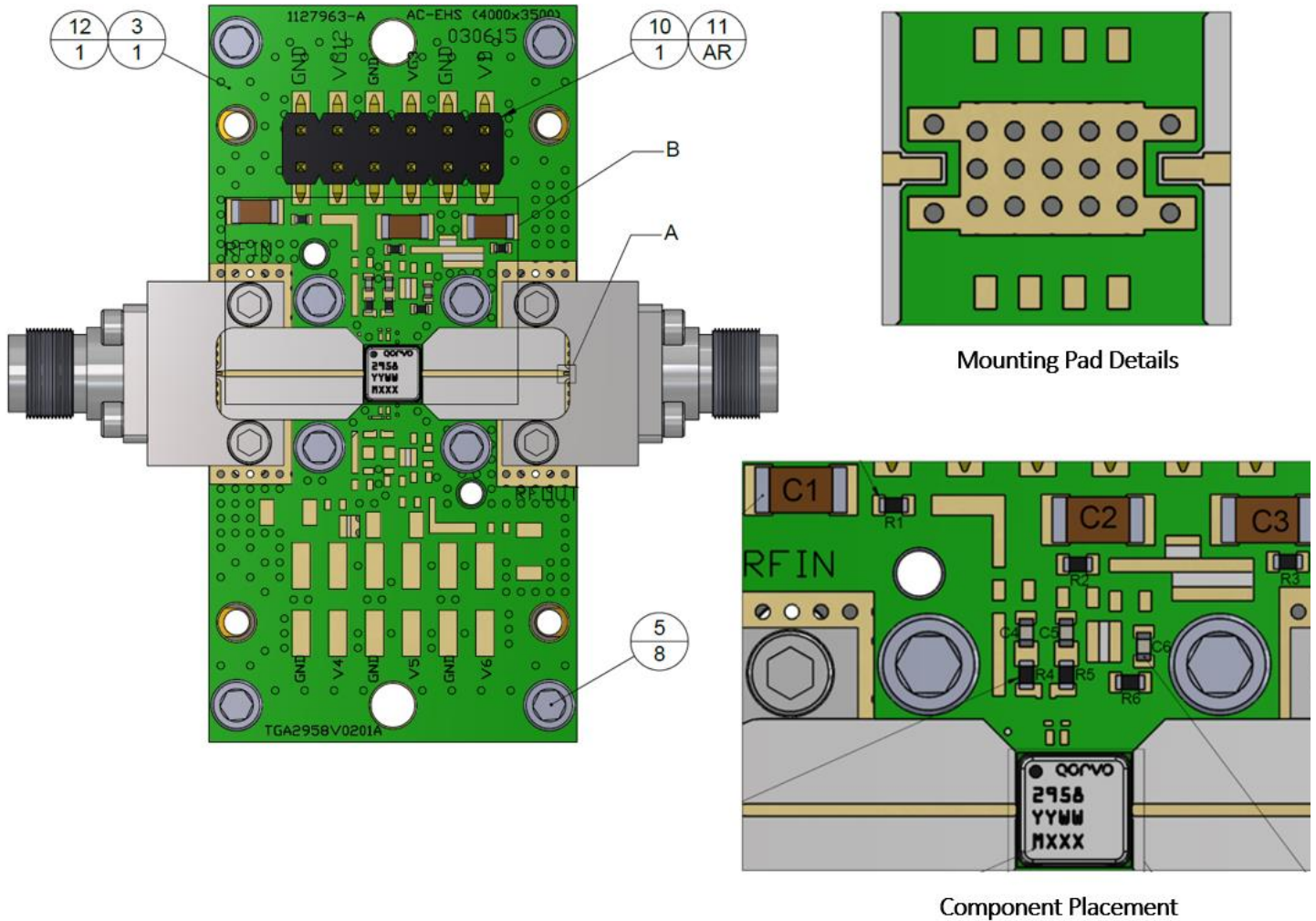

Bill of Materials

Reference Des.	Value	Description	Manuf.	Part Number
C1, C2, C3	10 μ F	Cap., 1206, +50 V, 20 %, X5R	Various	-
C4, C5, C6	0.01 μ F	Cap., 0402, +50 V, 10 %, X7R	Various	-
R1, R2, R3	5.1 Ohms	Res., 0402, 5 %, SMD	Various	-
R4, R5, R6	0.0 Ohms	Res., 0402, 5 %, SMD	Various	-

Mechanical Information

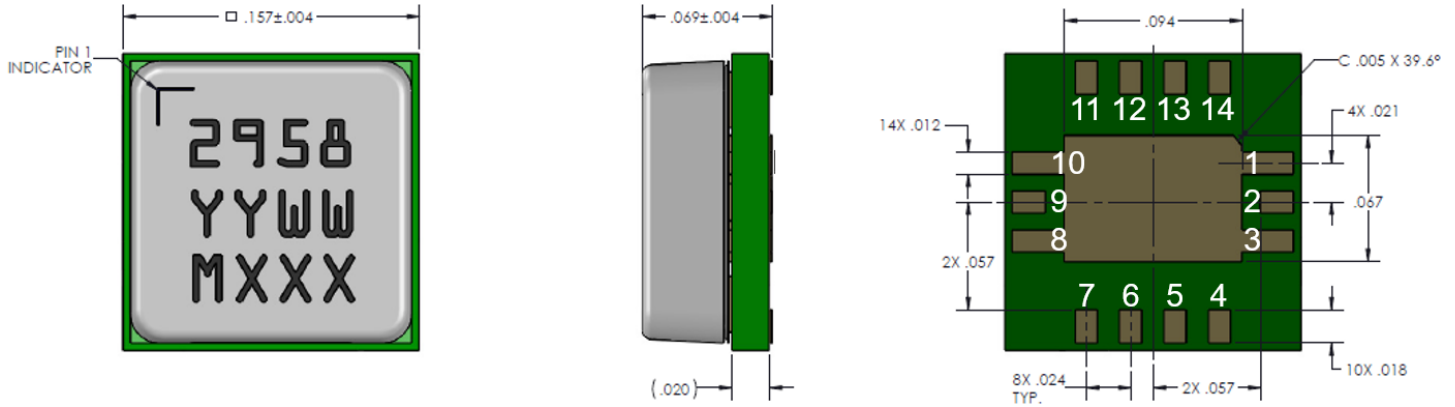

Units: inches

Tolerances: unless specified

x.xx = ± 0.01

x.xxx = ± 0.005

Marking:

2958: Part number

YY: Part Assembly year

WW: Part Assembly week

MXXX: Batch ID

Pad Description

Pad No.	Symbol	Description
1, 3, 8, 10	GND	RF Ground
2	RF _{IN}	RF Input; matched to 50 Ω; DC blocked
4, 5, 6, 7, 12	NC	No connection inside package; pads can be grounded if desired
9	RF _{OUT}	RF Output; matched to 50 Ω; DC blocked
11	V _D	Drain voltage; Bias network is required; see recommended Application Information
13	V _{G3} (1)	Gate Voltage; Bias network is required; see recommended Application Information
14	V _{G12} (1)	Gate Voltage; Bias network is required; see recommended Application Information

Notes:

1. Pads 13 & 14 may be tied together for biasing

Absolute Maximum Ratings

Parameter	Value / Range
Drain Voltage (V_D)	29.5 V
Gate Voltage Range (V_G)	-8 to 0 V
Drain Current – common drain	576 mA
- 1 st Stage (I_{D1})	72 mA
- 2 nd Stage (I_{D2})	192 mA
- 3 rd Stage (I_{D3})	384 mA
Forward Gate Current (I_G)	See I_{G_MAX} plot (page 8)
Power Dissipation (P_{DISS}), 85 °C	13 W
Input Power (P_{IN}), CW, 50 Ω , $V_D = +22$ V, $I_{DQ} = 70$ mA, 85 °C	27 dBm
Input Power (P_{IN}), CW, VSWR 3:1, $V_D = +22$ V, $I_{DQ} = 70$ mA, 85 °C	20 dBm
Storage Temperature	-55 to 150 °C

Operation of this device outside the parameter ranges given above may cause permanent damage. These are stress ratings only, and functional operation of the device at these conditions is not implied.

Assembly Notes

Compatible with lead-free soldering processes with 260°C peak reflow temperature.

This package is air-cavity and non-hermetic, and therefore cannot be subjected to aqueous washing. The use of no-clean solder to avoid washing after soldering is highly recommended.

Contact plating: Ni-Au

Solder rework not recommended

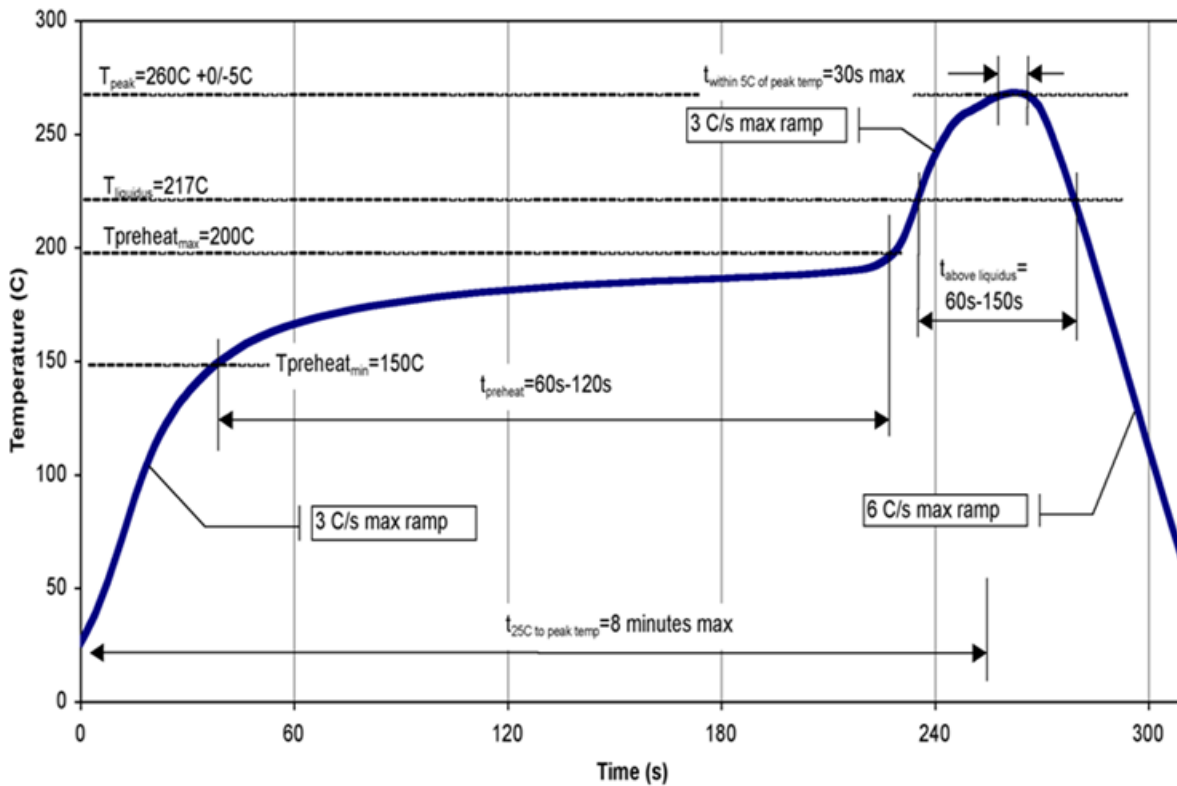

Recommended Soldering Temperature Profile

Handling Precautions

Parameter	Rating	Standard
ESD – Human Body Model (HBM)	Class 1A	ANSI/ESD/JEDEC JS-001, TA=25°C
ESD – Charge Device Model (CDM)	Class C3	ANSI /ESD/JEDEC JS-002, TA=25°C
MSL – Convection Reflow 260 °C	MSL 3	IPC/JEDEC J-STD-020, Classification Tb=260°C



Caution!
ESD-Sensitive
Device

RoHS Compliance

This product is compliant with the 2011/65/EU RoHS directive (Restrictions on the Use of Certain Hazardous Substances in Electrical and Electronic Equipment), as amended by Directive 2015/863/EU. This product also has the following attributes:

- Lead Free
- Halogen Free (Chlorine, Bromine)
- Antimony Free
- TBBP-A (C₁₅H₁₂Br₄O₂) Free

Contact Information

For the latest specifications, additional product information, worldwide sales and distribution locations:

Tel: 1-844-890-8163

Web: www.qorvo.com

Email: customer.support@qorvo.com

Important Notice

The information contained herein is believed to be reliable; however, Qorvo makes no warranties regarding the information contained herein and assumes no responsibility or liability whatsoever for the use of the information contained herein. All information contained herein is subject to change without notice. Customers should obtain and verify the latest relevant information before placing orders for Qorvo products. The information contained herein or any use of such information does not grant, explicitly or implicitly, to any party any patent rights, licenses, or any other intellectual property rights, whether with regard to such information itself or anything described by such information. **THIS INFORMATION DOES NOT CONSTITUTE A WARRANTY WITH RESPECT TO THE PRODUCTS DESCRIBED HEREIN, AND QORVO HEREBY DISCLAIMS ANY AND ALL WARRANTIES WITH RESPECT TO SUCH PRODUCTS WHETHER EXPRESS OR IMPLIED BY LAW, COURSE OF DEALING, COURSE OF PERFORMANCE, USAGE OF TRADE OR OTHERWISE, INCLUDING THE IMPLIED WARRANTIES OF MERCHANTABILITY AND FITNESS FOR A PARTICULAR PURPOSE.**

Without limiting the generality of the foregoing, Qorvo products are not warranted or authorized for use as critical components in medical, life-saving, or life-sustaining applications, or other applications where a failure would reasonably be expected to cause severe personal injury or death.

Copyright 2019 © Qorvo, Inc. | Qorvo is a registered trademark of Qorvo, Inc.

X-ON Electronics

Largest Supplier of Electrical and Electronic Components

Click to view similar products for [RF Amplifier](#) category:

Click to view products by [Qorvo](#) manufacturer:

Other Similar products are found below :

[A82-1](#) [BGA622H6820XTSA1](#) [BGA 728L7 E6327](#) [BGB719N7ESDE6327XTMA1](#) [HMC397-SX](#) [HMC405](#) [HMC561-SX](#) [HMC8120-SX](#)
[HMC8121-SX](#) [HMC-ALH382-SX](#) [HMC-ALH476-SX](#) [SE2433T-R](#) [SMA3101-TL-E](#) [SMA39](#) [A66-1](#) [A66-3](#) [A67-1](#) [LX5535LQ](#) [LX5540LL](#)
[MAAM02350](#) [HMC3653LP3BETR](#) [HMC549MS8GETR](#) [HMC-ALH435-SX](#) [SMA101](#) [SMA32](#) [SMA411](#) [SMA531](#) [SST12LP17E-XX8E](#)
[SST12LP19E-QX6E](#) [WPM0510A](#) [HMC5929LS6TR](#) [HMC5879LS7TR](#) [HMC1126](#) [HMC1087F10](#) [HMC1086](#) [HMC1016](#) [SMA1212](#)
[MAX2689EWS+T](#) [MAAMSS0041TR](#) [MAAM37000-A1G](#) [LTC6430AIUF-15#PBF](#) [CHA5115-QDG](#) [SMA70-2](#) [SMA4011](#) [A231](#) [HMC-](#)
[AUH232](#) [LX5511LQ](#) [LX5511LQ-TR](#) [HMC7441-SX](#) [HMC-ALH310](#)