

### General Description

The Qorvo TGA4030-SM is a Medium Power Amplifier and Multiplier for wide band 17–37 GHz applications. The part is designed using Qorvo’s 0.15 um power pHEMT process.

The TGA4030-SM provides a nominal 20 dB small signal gain with 22 dBm maximum output power. For 2x and 3x Multiplier Function, TGA4030-SM provides 15 dBm typical output power @ 9 dBm P<sub>IN</sub>.

This part is ideally suited for applications such as Point-to-Point Radio, EW, instrumentation and frequency multipliers.

### Product Features

- RF Output Frequency Range: 17-37 GHz
- 20 dB Nominal Gain
- 22 dBm Nominal Output Maximum Power
- 2x and 3x Multiplier Function
- Bias: V<sub>D</sub> = 5 V, I<sub>D</sub> = 140 mA
- Package Dimensions: 3.0 x 3.0 x 0.85 mm



### Measured Performance

Bias at V<sub>D</sub> = 5 V, I<sub>D</sub> = 140 mA and V<sub>G</sub> = -0.75 V (Typical)

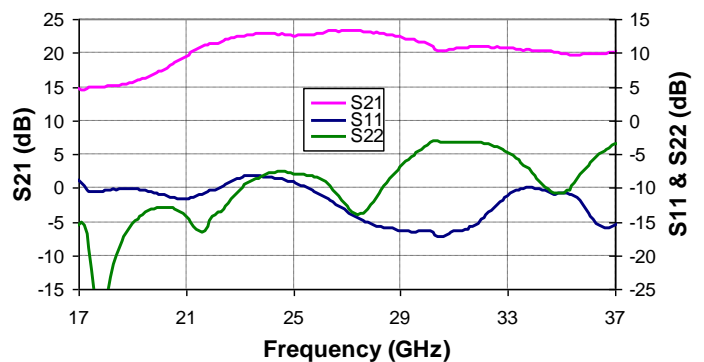

Bias at V<sub>D</sub> = 5 V, I<sub>D</sub> = 140 mA and V<sub>G</sub> = -0.75 V (Typical)

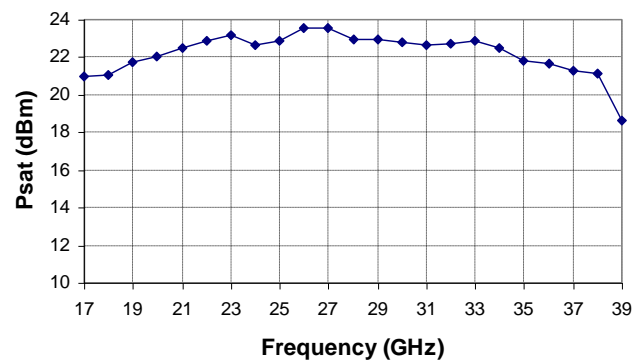

### Applications

- Point-to-Point Radio
- EW
- Instrumentation
- Frequency Multiplier

### Ordering Information

Part	Description
TGA4030-SM	Amplifier, Waffle Pack, Qty 100
TGA4030-SMEVB	TGA4030-SM Evaluation Board, Qty 1

### Absolute Maximum Ratings

Symbol	Parameter	Value/Range	Notes
$V_{D-V_G}$	Drain to Gate Voltage	8	V
$V_D$	Drain Supply Voltage Range	6	V
$V_G$	Gate Supply Voltage Range	-3 – 0	V
$I_D$	Drain Current	400	mA
$I_G$	Gate Current	1.38	mA
$P_{IN}$	Input Continuous Wave Power	20	dBm
$T_S$	Storage Temperature	-55 to +150	°C

Operation of this device outside the parameter ranges given above may cause permanent damage. These are stress ratings only, and functional operation of the device at these conditions is not implied. Extended application of Absolute Maximum Rating conditions to the device may reduce device reliability.

### Recommended Operating Conditions

See application pages for amplifier, 2x multiplier and 3x multiplier bias conditions

Symbol	Parameter	Value/Range, Amp	Value/Range, x2 Multi	Value/Range, x3 Multi	Units
$V_D$	Drain Voltage	5	5	5	V
$I_D$	Drain Current	140	120	160	mA
$V_G$	Gate Voltage (Typ)	-0.75	-0.75	-0.75	V
$V_{D1}$	Drain Voltage	5	5	1	V
$V_{G1}$	Gate Voltage	same as $V_G$	-1.1	same as $V_G$	V

### RF Characterization Table

See application pages for amplifier, 2x multiplier and 3x multiplier bias conditions,  $T_A = 25\text{ °C}$

Data de-embedded to reference lines

Parameter	Amplifier	2x Multiplier	3x Multiplier	Units
RF Output Frequencies	17-37	22-38	23-31	GHz
S21, Small Signal Gain	20			dB
S11, Input Return Loss	10			dB
S22, Output Return Loss	5	5	5	dB
$P_{SAT}$ , Maximum Output Power	22			dBm
P1dB, Output Power @ 1 dB Gain Compression	18			dBm
IMD3@ 11 dBm $P_{OUT}$ /Tone	30			dBc
Output Power @ $P_{IN} = 9\text{ dBm}$		15	15	dBm
Conversion Gain		9	5	dB
Gain Temperature coefficient	-0.04			dB/°C

Measured Data, Amplifier

Bias Conditions:  $V_D = 5\text{ V}$ ,  $I_{DQ} = 140\text{ mA}$ ,  $V_G = -0.75\text{ V}$  (Typical),  $25\text{ }^\circ\text{C}$

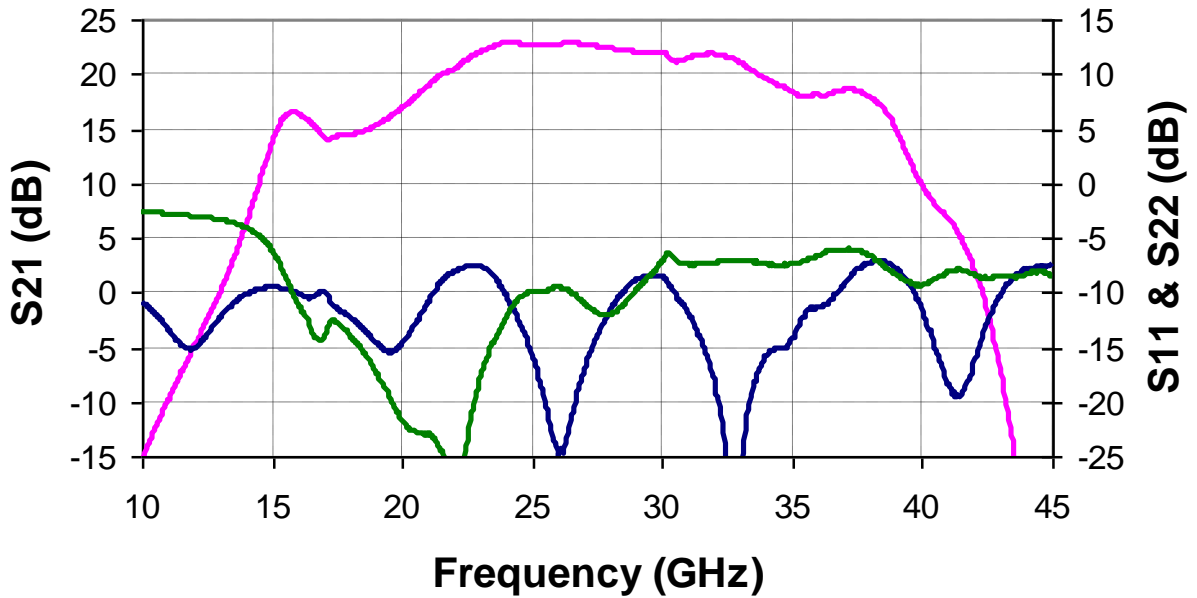

This is device s-parameter

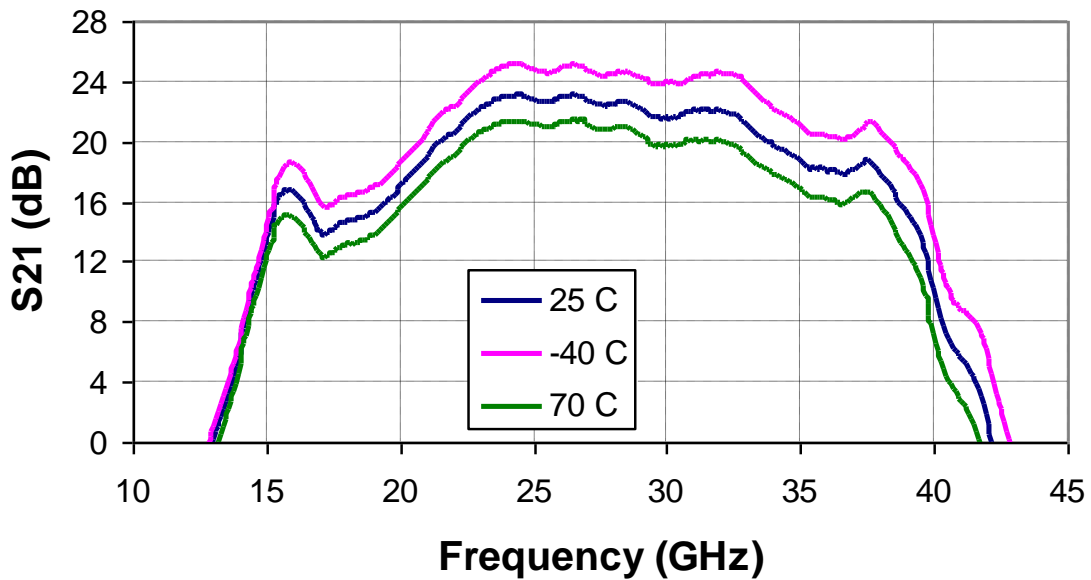

This is evaluation board s-parameter

Measured Data, Amplifier

Bias Conditions:  $V_D = 5\text{ V}$ ,  $I_{DQ} = 140\text{ mA}$ ,  $V_G = -0.75\text{ V}$  (Typical),  $25\text{ }^\circ\text{C}$

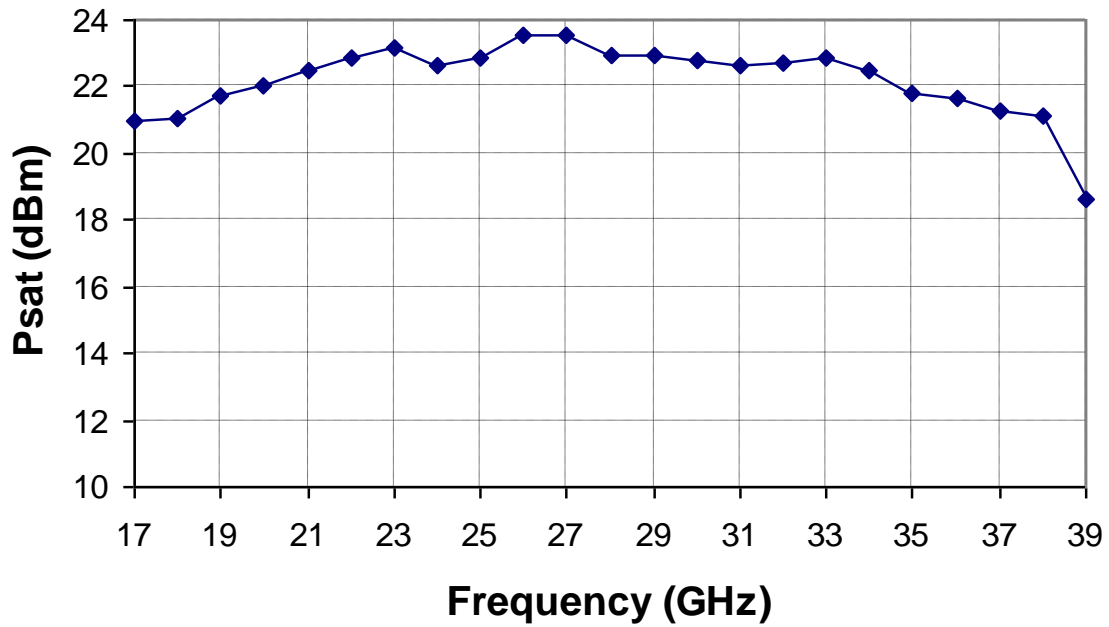
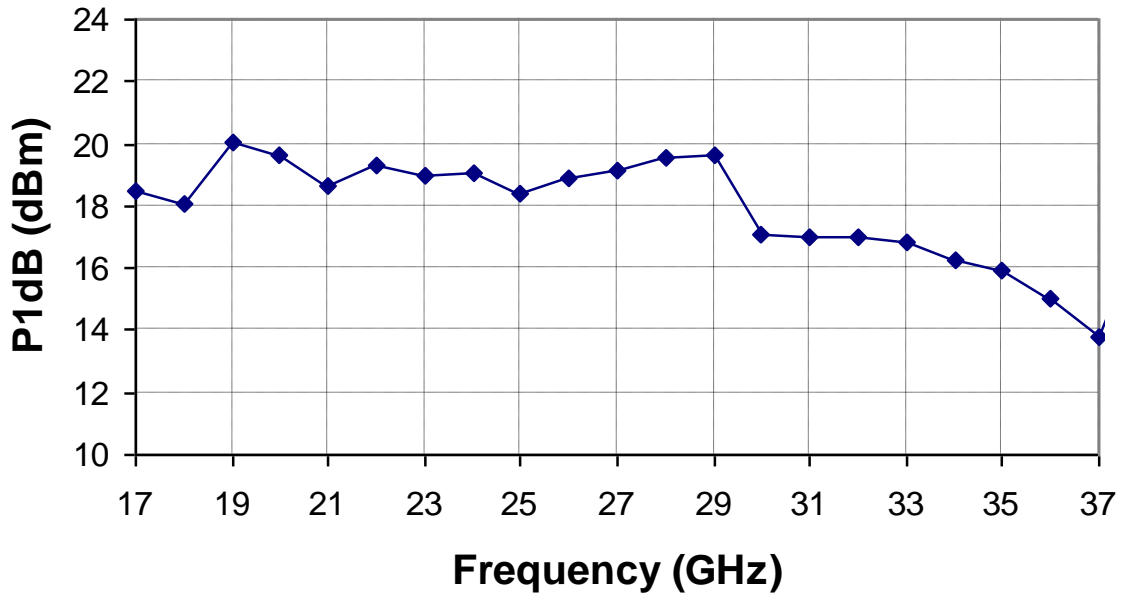

Measured Data, Amplifier

Bias Conditions:  $V_D = 5\text{ V}$ ,  $I_{DQ} = 140\text{ mA}$ ,  $V_G = -0.75\text{ V}$  (Typical),  $25\text{ }^\circ\text{C}$

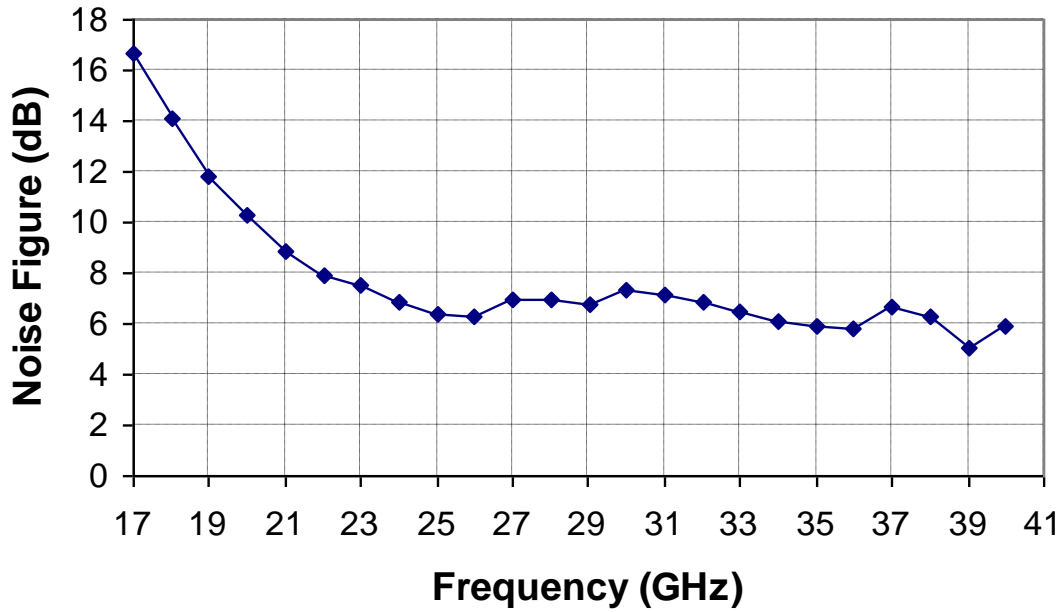
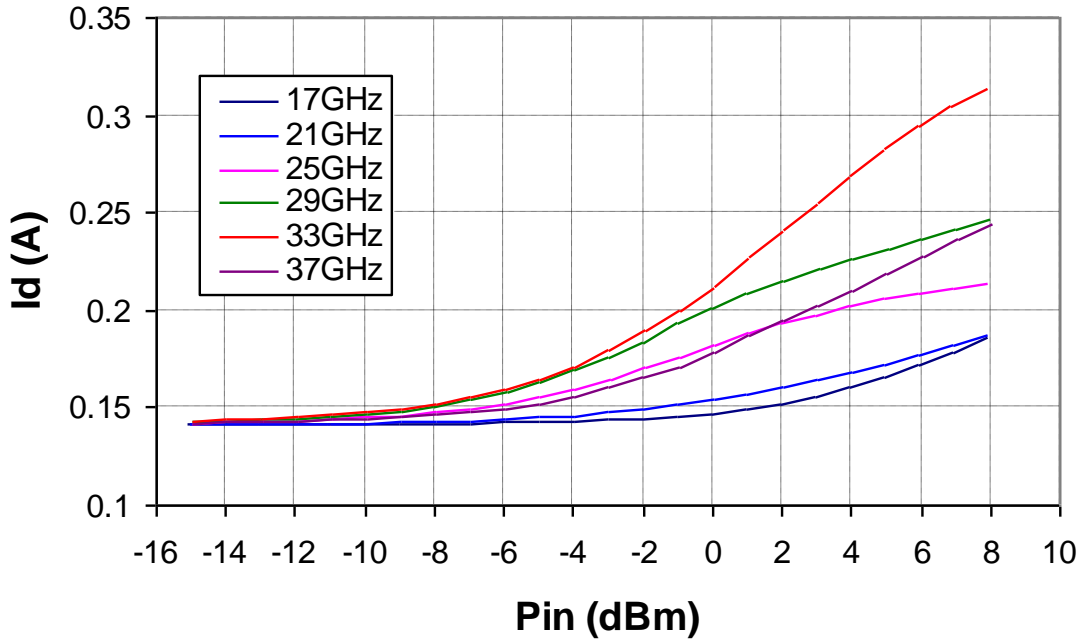

Measured Data, Amplifier

Bias Conditions:  $V_D = 5\text{ V}$ ,  $I_{DQ} = 140\text{ mA}$ ,  $V_G = -0.75\text{ V}$  (Typical),  $25\text{ }^\circ\text{C}$

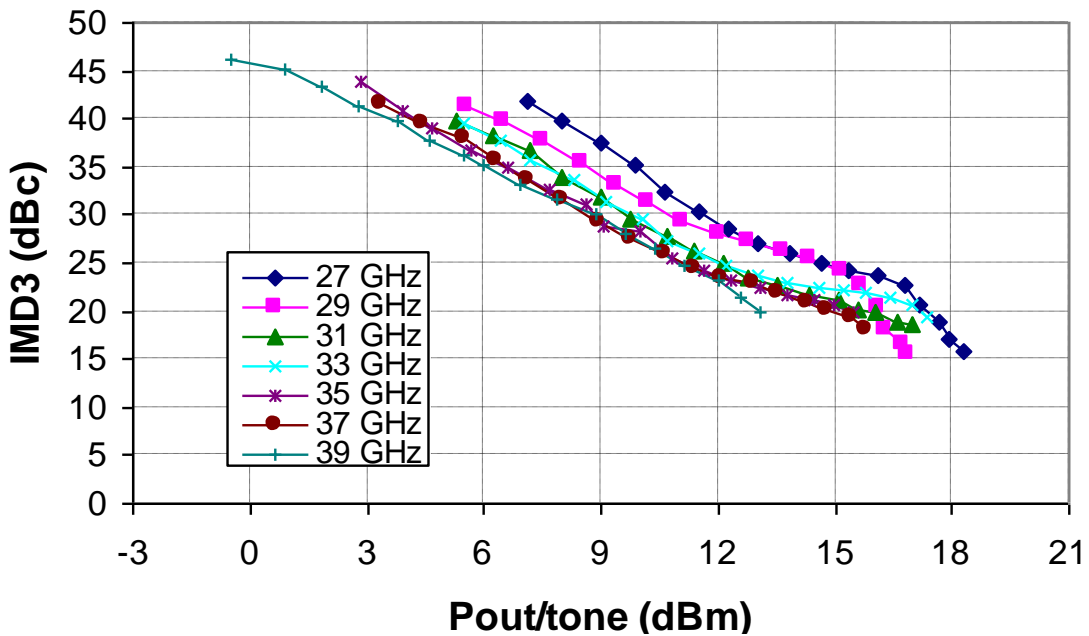
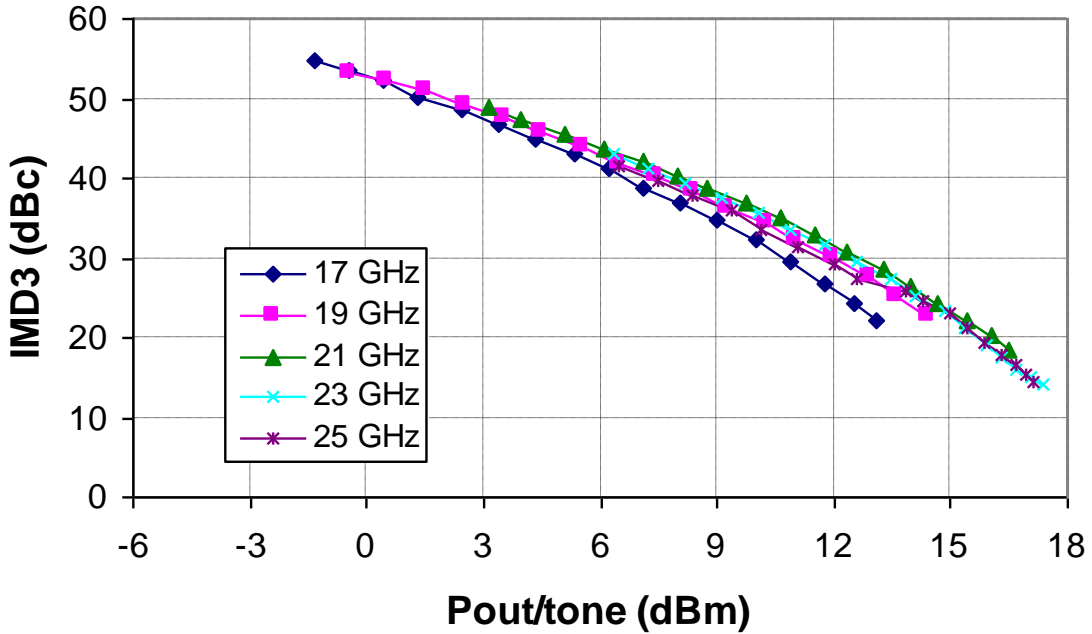

Measured Data, Amplifier

Bias Conditions:  $V_D = 5\text{ V}$ ,  $I_{DQ} = 140\text{ mA}$ ,  $V_G = -0.75\text{ V}$  (Typical),  $25\text{ }^\circ\text{C}$

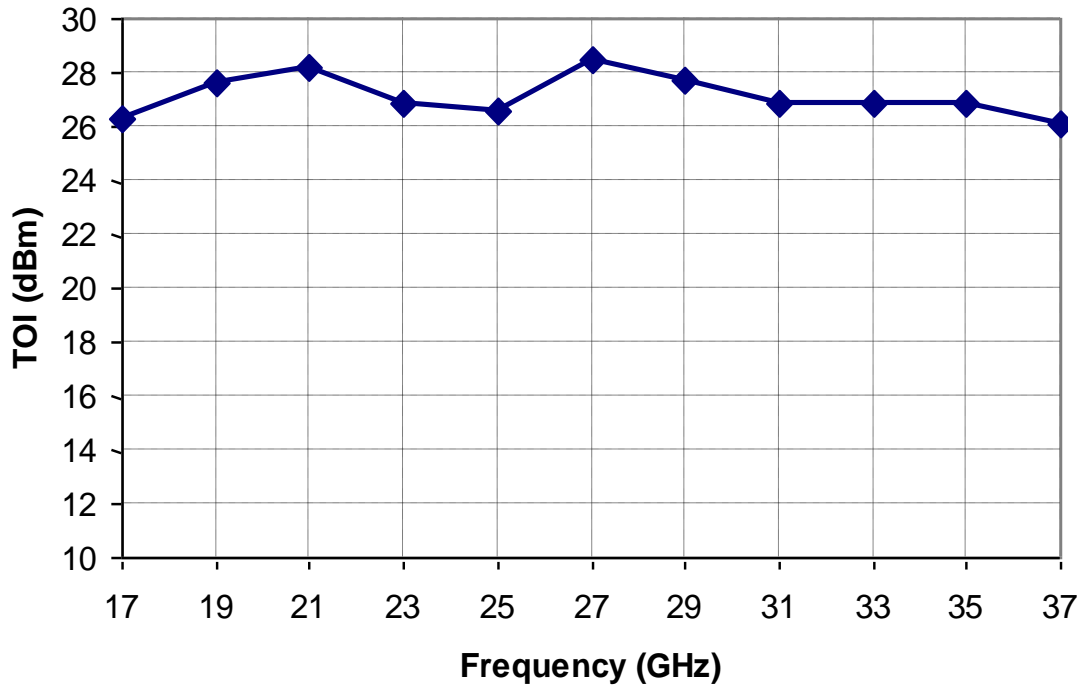

Measured Data, 2X Multiplier

Bias Conditions:  $V_D = 5\text{ V}$ ,  $I_{DQ} = 120\text{ mA}$ ,  $V_{G1} = -1.1\text{ V}$ ,  $P_{IN} = 9\text{ dBm}$ ,  $25\text{ }^\circ\text{C}$

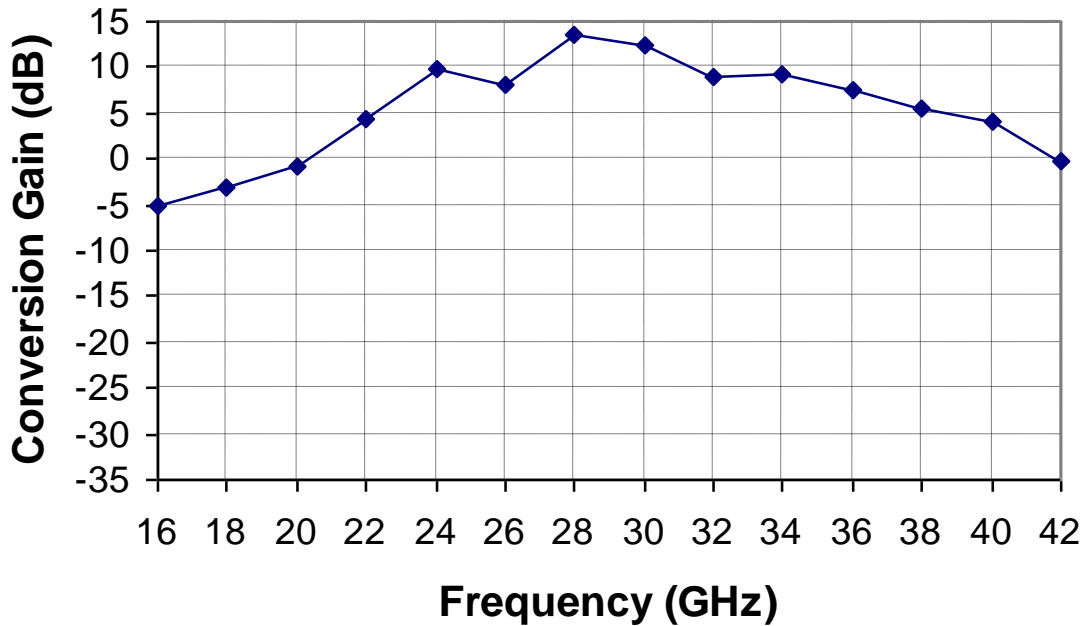
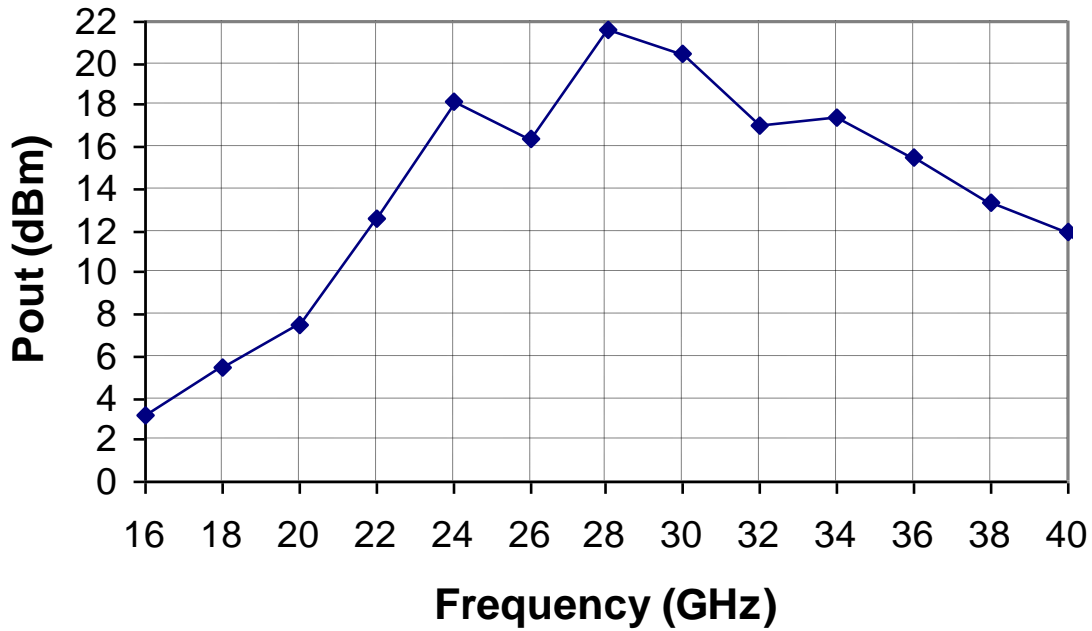



**Measured Data, 3X Multiplier**

Bias Conditions:  $V_D = 5\text{ V}$ ,  $V_{D1} = 1\text{ V}$ ,  $I_{DQ} = 160\text{ mA}$ ,  $P_{IN} = 9\text{ dBm}$ ,  $25\text{ }^\circ\text{C}$

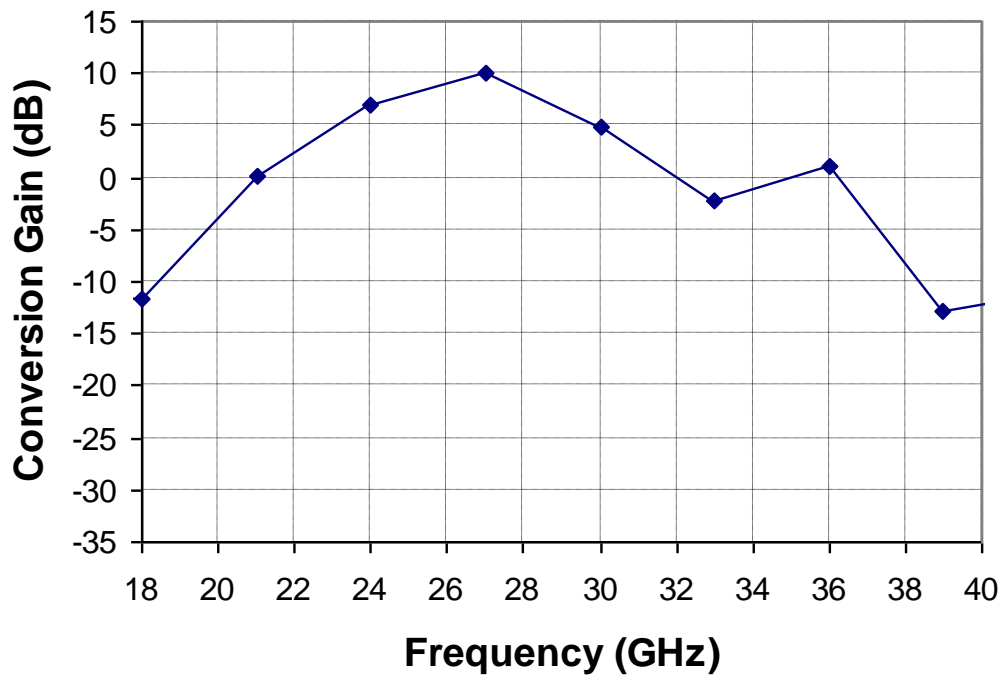
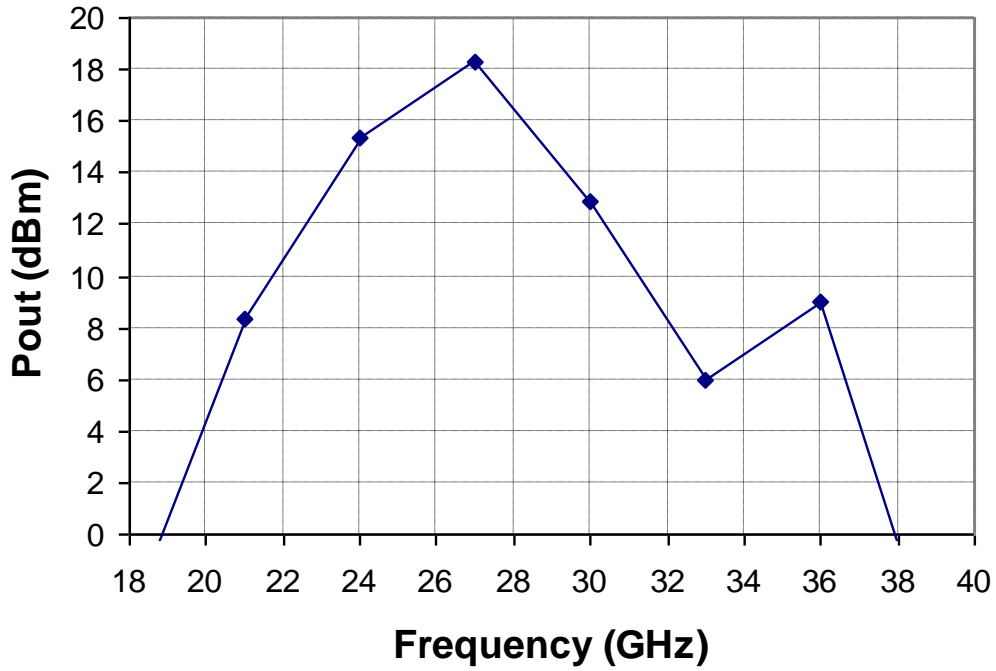

**Power Dissipation and Thermal Properties**

Parameter	Test Conditions	Value	Units
Thermal Resistance ( $\theta_{JC}$ )	Under RF Drive $P_D = 1.2\text{ W}$ $T_{BASEPLATE} = 70\text{ }^\circ\text{C}$	66.7	$^\circ\text{C/W}$
Channel Temperature ( $T_{CH}$ ) <sup>(2)</sup>		150	$^\circ\text{C}$
Median Lifetime ( $T_M$ ) <sup>(1)</sup>		1.0 E + 6	Hrs
Thermal Resistance ( $\theta_{JC}$ )	Quiescent, Small Signal $V_D = 5\text{ V}, I_D = 140\text{ mA}, P_D = 0.7\text{ W}$ $T_{BASEPLATE} = 70\text{ }^\circ\text{C}$	65.7	$^\circ\text{C/W}$
Channel Temperature ( $T_{CH}$ ) <sup>(2)</sup>		116	$^\circ\text{C}$
Median Lifetime ( $T_M$ ) <sup>(1)</sup>		2.4 E+7 Hrs	Hrs

Notes:

- For a median life,  $T_m$ , of 1 E+6 hours, power dissipation is limited to  $P_D(\text{max}) = (T_{\text{CHANNEL}}\text{ }^\circ\text{C} - T_{\text{BASE}}\text{ }^\circ\text{C})/\theta_{JC}$
- Channel operating temperature will directly affect the device median time to failure (MTTF). For maximum life, it is recommended that channel temperatures be maintained at the lowest possible levels.

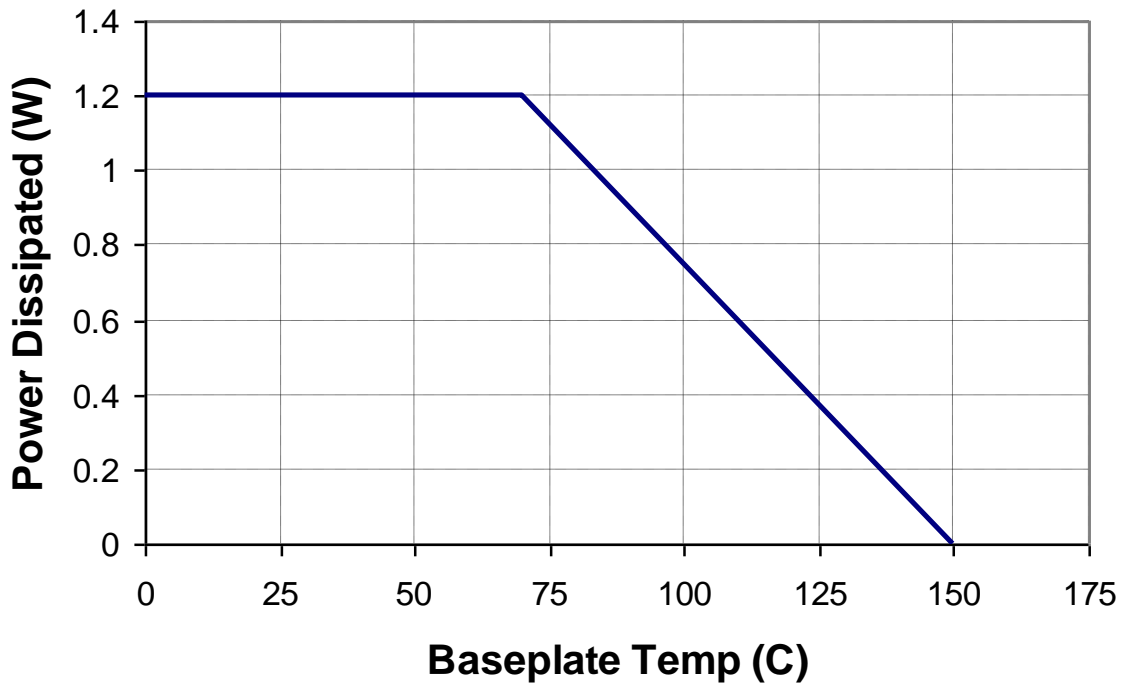

Mechanical Drawing & Pad Description

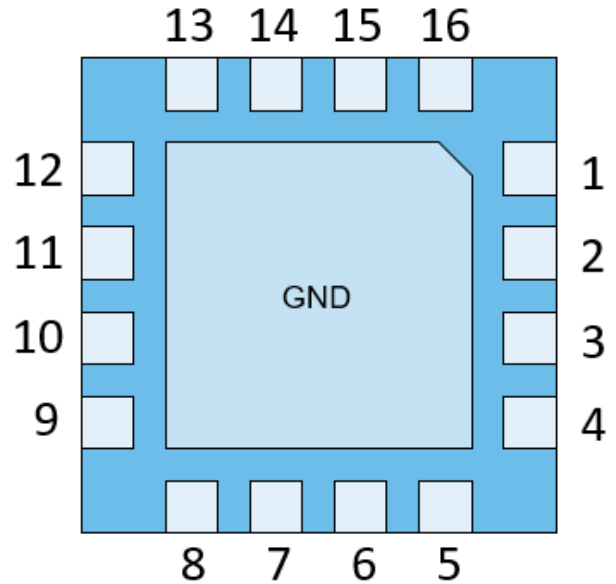

Pin Number	Label	Description
1, 2, 4, 9, 11, 12 (slug)	GND	Ground
3	RF Input	Matched to 50 ohms, DC blocked
5	VG1	Stage 1 Gate Voltage
7	VG	Other Stages Gate Voltage
10	RF Output	Matched to 50 ohms, DC blocked
14	VD	Other Stages Drain Voltage
16	VD1	Stage 1 Drain Voltage
6, 8, 13, 15	N/C	No internal connection. Recommend to GND at the PCB level

Mechanical Drawing

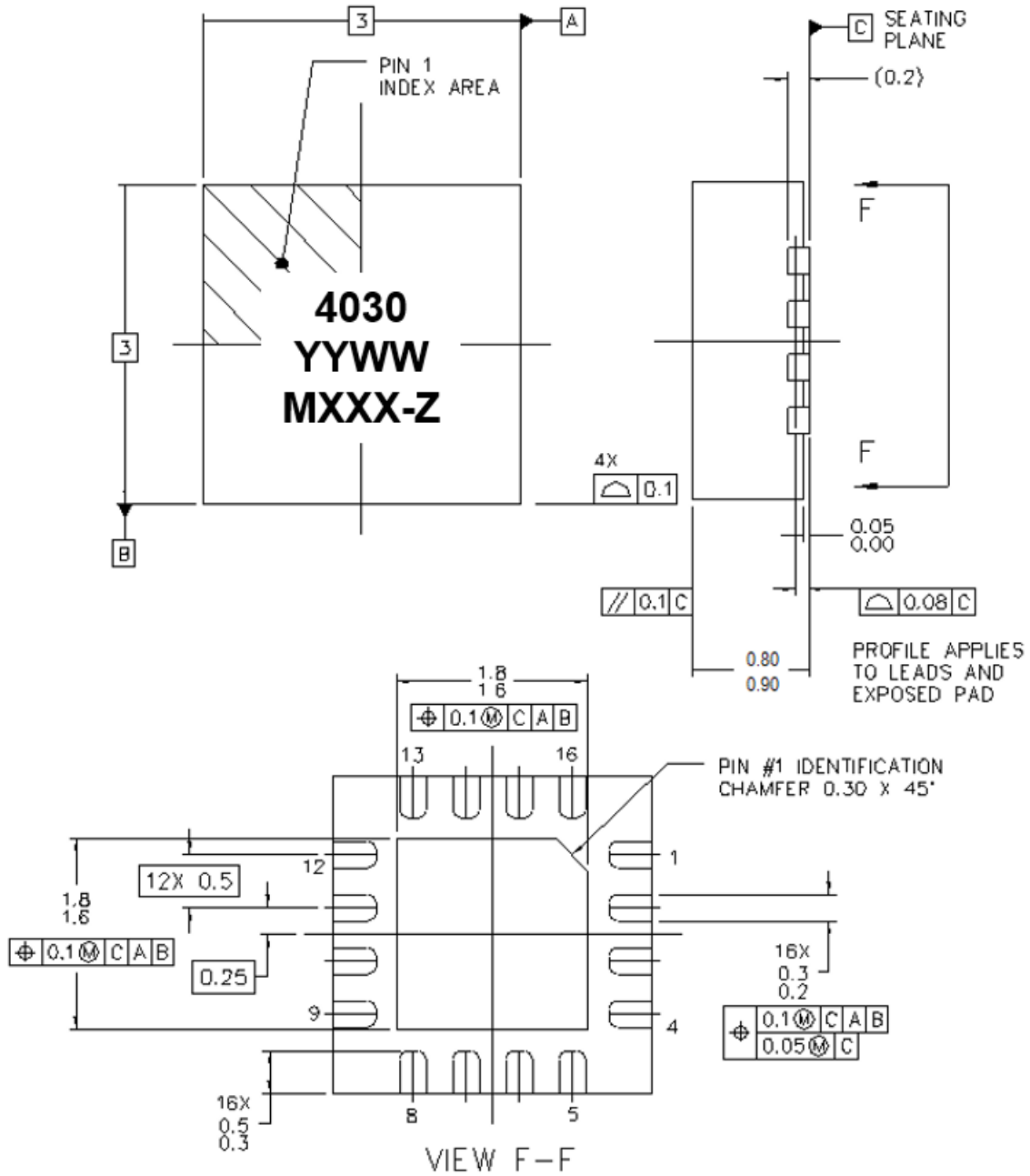

Dimensions in mm, package is mold encapsulated with Tin plated lead finish  
 Part Marking: 4030 = Part Number, YY = Part Assembly Year  
 WW = Part Assembly Week, MXXX-Z = Batch ID

Evaluation Board

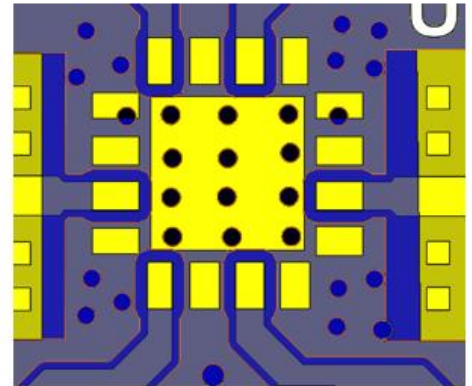
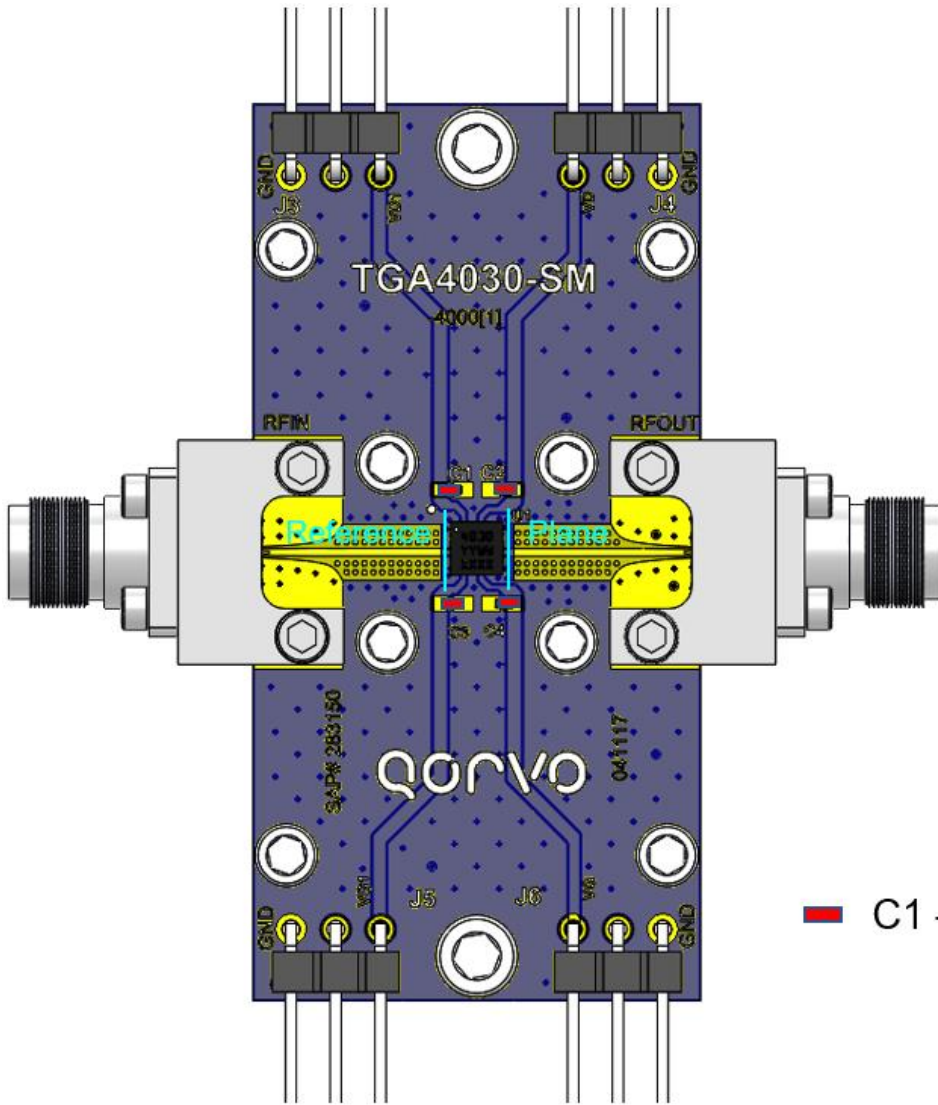

Mounting Pad Details

■ C1 – C4, 0.01 uF

Notes:

1. C1 – C4 0402 0.01 uF capacitors
2. Board material is 8 mil ROGERS RO4003

Application Circuit, Device as Amplifier

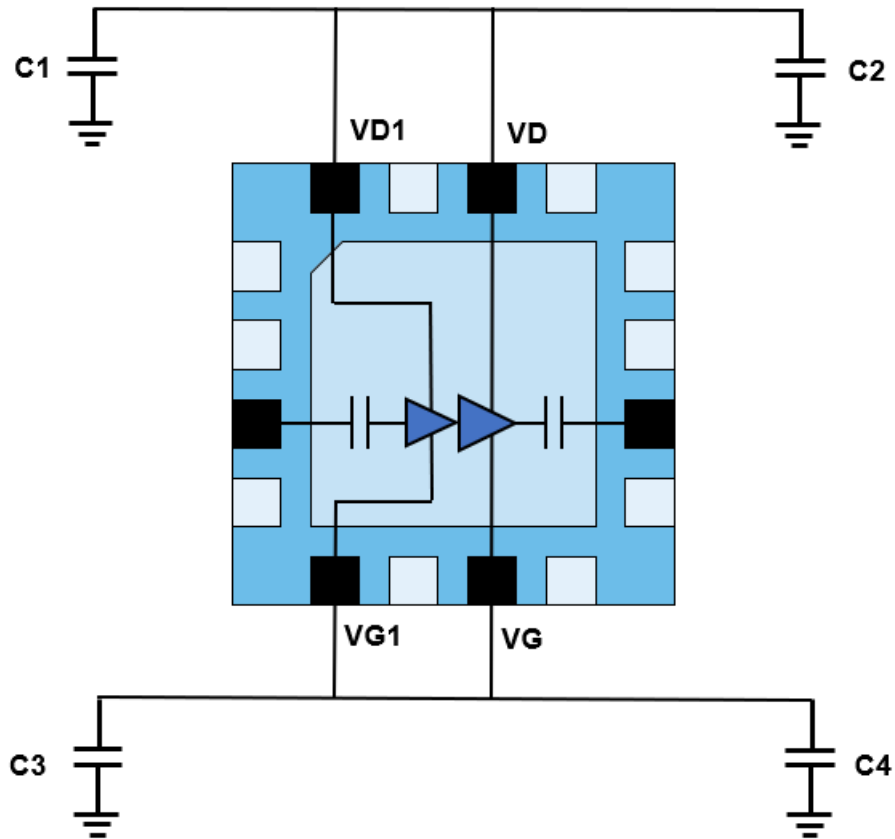

**Bias-up Procedure**

1. Set  $I_D$  limit to 400 mA,  $I_G$  limit to 2 mA
2. Set  $V_G$  to  $-1.5$  V
3. Set  $V_D$  +5 V
4. Adjust  $V_G$  more positive until  $I_{DQ} = 140$  mA
5. Apply RF signal

**Bias-down Procedure**

1. Turn off RF signal
2. Reduce  $V_G$  to  $-1.5$  V. Ensure  $I_{DQ} \sim 0$  mA
3. Set  $V_D$  to 0 V
4. Turn off  $V_D$  supply
5. Turn off  $V_G$  supply

Application Circuit, Device as x2 Multiplier

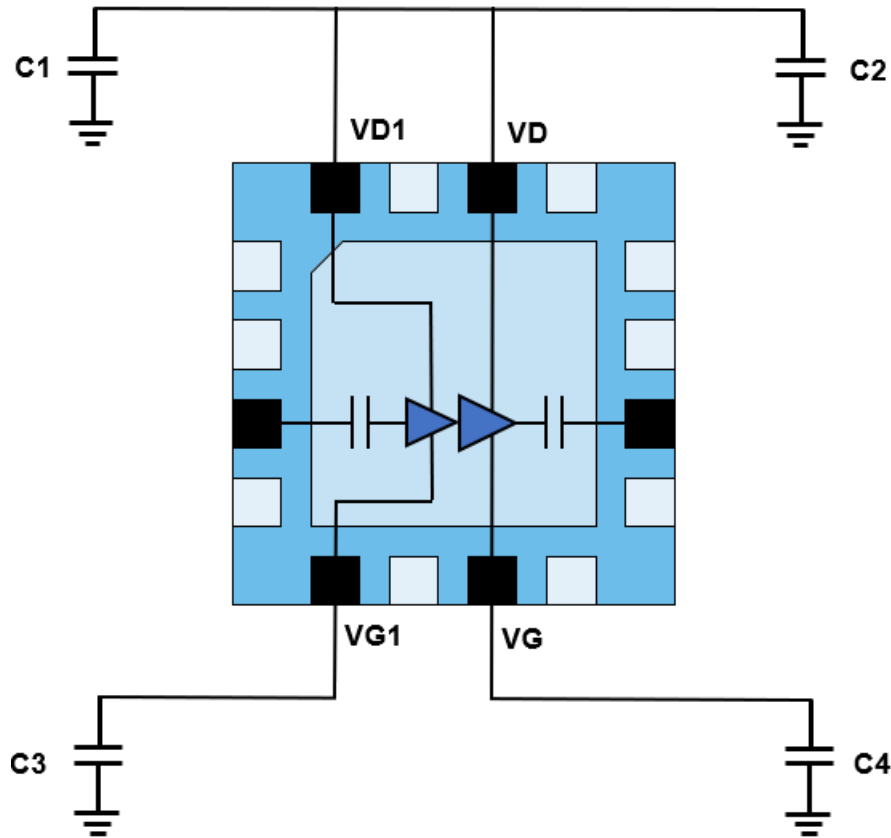

**Bias-up Procedure**

1. Set  $I_D$  limit to 400 mA,  $I_G$  and  $I_{G1}$  limit to 2 mA each.
2. Set  $V_G$  to  $-1.5$  V, Set  $V_{G1} = -1.1$  V (fixed)
3. Set  $V_D +5$  V
4. Adjust  $V_G$  more positive until  $I_{DQ} = 120$  mA
5. Apply RF signal

**Bias-down Procedure**

1. Turn off RF signal
2. Reduce  $V_G$  to  $-1.5$  V. Ensure  $I_{DQ} \sim 0$  mA
3. Set  $V_D$  to 0 V
4. Turn off  $V_D$  supply
5. Turn off  $V_G$  and  $V_{G1}$  supply

Application Circuit, Device as x3 Multiplier

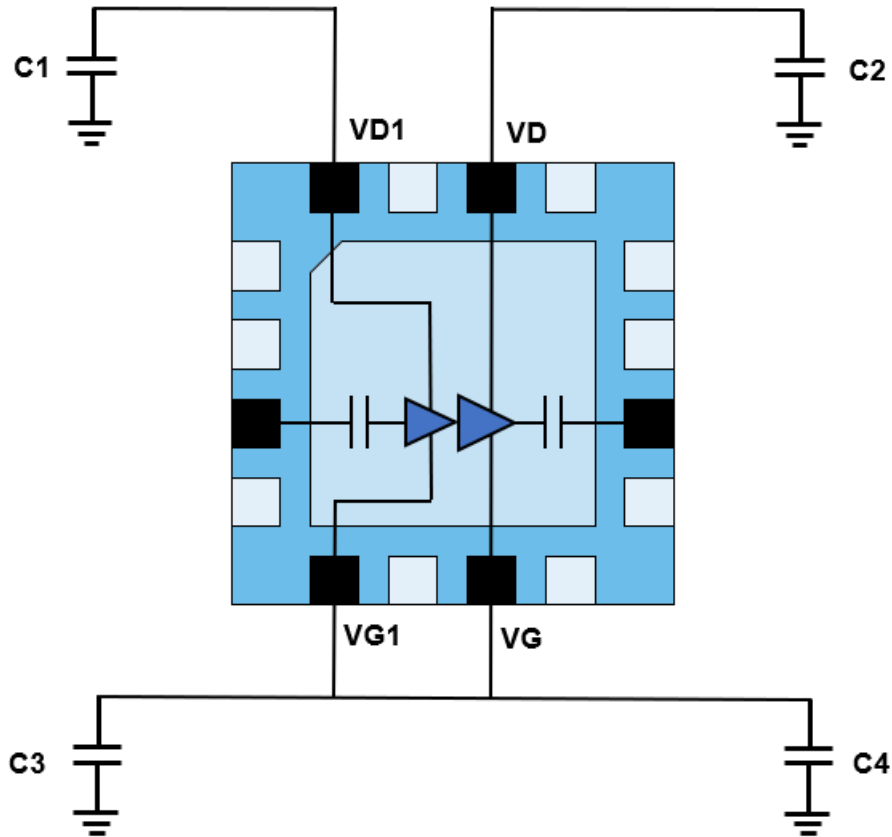

**Bias-up Procedure**

1. Set  $I_D$  limit to 400 mA, Set  $I_{D1}$  Limit to 50 mA,  $I_G$  limit to 2 mA
2. Set  $V_G$  to  $-1.5$  V
3. Set  $V_D = +5$  V, Set  $V_{D1} = +1$  V
4. Adjust  $V_G$  more positive until  $I_{D1} + I_D = 160$  mA
5. Apply RF signal

**Bias-down Procedure**

1. Turn off RF signal
2. Reduce  $V_G$  to  $-1.5$  V. Ensure  $I_{DQ} \sim 0$  mA
3. Set  $V_{D1}$  and  $V_D$  to 0 V
4. Turn off  $V_{D1}$  and  $V_D$  supply
5. Turn off  $V_G$  supply



## Recommended Surface Mount Package Assembly

Clean the board with acetone. Rinse with alcohol. Allow the circuit to fully dry.

Qorvo recommends using a conductive solder paste for attachment. Follow solder paste and reflow oven vendors' recommendations when developing a solder reflow profile.

Hand soldering is not recommended. Solder paste can be applied using a stencil printer or dot placement. The volume of solder paste depends on PCB and component layout and should be well controlled to ensure consistent mechanical and electrical performance

## Typical Solder Reflow Profiles

Reflow Profiles	SnPb	Pb Free
Ramp-up rate	3 °C/sec	3 °C/sec
Activation Time and Temperature	60-120 sec @ 140-160 °C	60-180 sec @ 150-200 °C
Time above Melting point	60-150 sec	60-150 sec
Max Peak Temperature	240 °C	260 °C
Time within 5 °C of Peak Temperature	10-20 sec	10-20 sec
Ramp-down Rate	4-6 °C/sec	4-6 °C/sec

### Handling Precautions

Parameter	Rating	Standard
ESD – Human Body Model (HBM)	0B	ESDA / JEDEC JS-001-2017
ESD – Charged Device Model (CDM)	C3	ESDA / JEDEC JS-002-2014
MSL – Moisture Sensitivity Level	3	JEDEC standard IPC/JEDEC J-STD-020



Caution!  
ESD-Sensitive Device

### RoHS Compliance

This product is compliant with the 2011/65/EU RoHS directive (Restrictions on the Use of Certain Hazardous Substances in Electrical and Electronic Equipment), as amended by Directive 2015/863/EU.

This product also has the following attributes:

- Lead Free
- Halogen Free (Chlorine, Bromine)
- Antimony Free
- TBBP-A (C<sub>15</sub>H<sub>12</sub>Br<sub>4</sub>O<sub>2</sub>) Free
- PFOS Free
- SVHC Free

### Contact Information

For the latest specifications, additional product information, worldwide sales and distribution locations.

Web: [www.qorvo.com](http://www.qorvo.com)

Tel: 1-844-890-8163

Email: [customer.support@qorvo.com](mailto:customer.support@qorvo.com)

### Important Notice

The information contained herein is believed to be reliable; however, Qorvo makes no warranties regarding the information contained herein and assumes no responsibility or liability whatsoever for the use of the information contained herein. All information contained herein is subject to change without notice. Customers should obtain and verify the latest relevant information before placing orders for Qorvo products. The information contained herein or any use of such information does not grant, explicitly or implicitly, to any party any patent rights, licenses, or any other intellectual property rights, whether with regard to such information itself or anything described by such information. **THIS INFORMATION DOES NOT CONSTITUTE A WARRANTY WITH RESPECT TO THE PRODUCTS DESCRIBED HEREIN, AND QORVO HEREBY DISCLAIMS ANY AND ALL WARRANTIES WITH RESPECT TO SUCH PRODUCTS WHETHER EXPRESS OR IMPLIED BY LAW, COURSE OF DEALING, COURSE OF PERFORMANCE, USAGE OF TRADE OR OTHERWISE, INCLUDING THE IMPLIED WARRANTIES OF MERCHANTABILITY AND FITNESS FOR A PARTICULAR PURPOSE.**

Without limiting the generality of the foregoing, Qorvo products are not warranted or authorized for use as critical components in medical, life-saving, or life-sustaining applications, or other applications where a failure would reasonably be expected to cause severe personal injury or death.

Copyright 2019 © Qorvo, Inc. | Qorvo is a registered trademark of Qorvo, Inc.

## X-ON Electronics

Largest Supplier of Electrical and Electronic Components

*Click to view similar products for [Amplifier IC Development Tools](#) category:*

*Click to view products by [Qorvo](#) manufacturer:*

Other Similar products are found below :

[EVAL-ADCMP566BCPZ](#) [EVAL-ADCMP606BKSZ](#) [AD8013AR-14-EBZ](#) [AD8033AKS-EBZ](#) [AD8044AR-EBZ](#) [AD8225-EVALZ](#)  
[ADA4859-3ACP-EBZ](#) [ADA4862-3YR-EBZ](#) [DEM-OPA-SO-2B](#) [AD744JR-EBZ](#) [AD8023AR-EBZ](#) [AD8030ARJ-EBZ](#) [AD8040ARU-EBZ](#)  
[AD8073JR-EBZ](#) [AD813AR-14-EBZ](#) [AD848JR-EBZ](#) [ADA4858-3ACP-EBZ](#) [ADA4922-1ACP-EBZ](#) [551600075-001/NOPB](#) [DEM-OPA-SO-2E](#) [THS7374EVM](#) [EVAL-ADCMP553BRMZ](#) [EVAL-ADCMP608BKSZ](#) [MIOP 42109](#) [EVAL-ADCMP609BRMZ](#) [ADA4950-1YCP-EBZ](#)  
[MAX9928EVKIT+](#) [MAX9611EVKIT](#) [MAX9937EVKIT+](#) [MAX9934TEVKIT+](#) [MAX44290EVKIT#](#) [MAX2644EVKIT](#) [MAX2634EVKIT](#)  
[MAX4073EVKIT+](#) [DEM-OPA-SO-2C](#) [MAX2643EVKIT](#) [ISL28158EVAL1Z](#) [MAX40003EVKIT#](#) [MAX2470EVKIT](#) [MAX2473EVKIT](#)  
[MAX2472EVKIT](#) [MAX4223EVKIT](#) [MAX9700BEVKIT](#) [MADL-011014-001SMB](#) [DC1685A](#) [DEM-OPA-SO-2D](#) [MAX2670EVKIT#](#) [DEM-OPA-SO-1E](#) [AD8137YCP-EBZ](#) [EVAL-ADA4523-1ARMZ](#)