

**19 - 38 GHz Medium Power Amplifier**

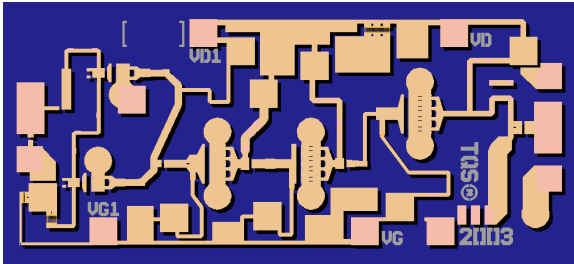

**Key Features**

- Frequency Range: 19 - 38 GHz
- 20 dB Nominal Gain
- 22 dBm Nominal Psat
- 30 dBm Nominal TOI
- Bias: 5 V, 160 mA (210mA @ P1dB)
- 0.25 um 3MI pHEMT Technology
- Chip Dimensions 1.69 x 0.75 x 0.10 mm (0.066 x 0.030 x 0.004 in)

**Product Description**

The TriQuint TGA4036 is a compact Medium Power Amplifier MMIC for Wide-band applications. The part is designed using TriQuint's proven standard 0.25 um power pHEMT production process.

The TGA4036 provides a nominal 20 dB Gain from 19-36 GHz, with Saturated Output Power of 22 dBm.

The part is ideally suited for low cost emerging markets such as Point-to-Point Radio, Point-to-Multi Point Communications, and Instrumentation.

The TGA4036 is 100% DC and RF tested on-wafer to ensure performance compliance.

Evaluation boards are available.

**Primary Applications**

- Point-to-Point Radio
- Point-to-Multipoint Communications
- Instrumentation

**Measured Fixtured Data**

Bias Conditions: Vd = 5 V, Id = 160 mA

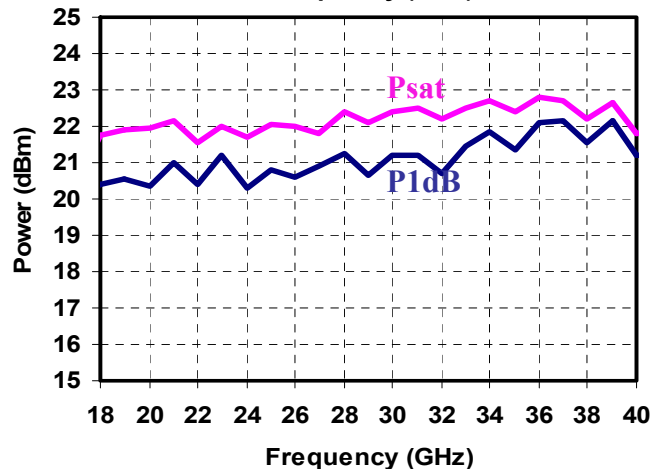
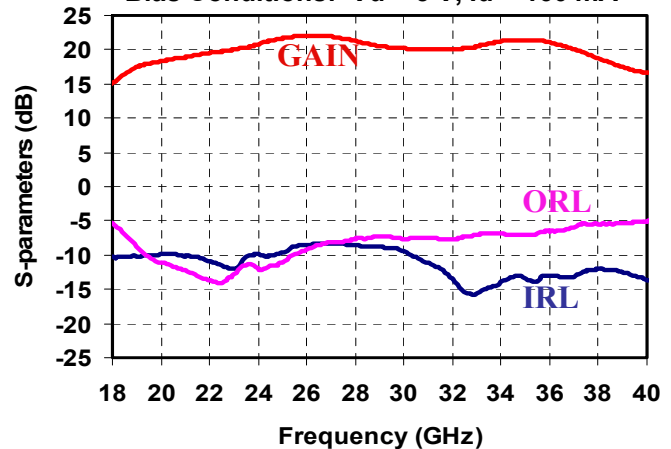

Datasheet subject to change without notice

**TABLE I  
 MAXIMUM RATINGS 1/**

SYMBOL	PARAMETER	VALUE	NOTES
V <sub>d</sub>	Drain Voltage	7 V	<u>2/</u>
V <sub>g</sub>	Gate Voltage Range	-1 TO +0.5 V	
I <sub>d</sub>	Drain Current	400 mA	<u>2/ 3/</u>
I <sub>g</sub>	Gate Current	7 mA	<u>3/</u>
P <sub>IN</sub>	Input Continuous Wave Power	20 dBm	
P <sub>D</sub>	Power Dissipation	2.5 W	<u>2/ 4/</u>
T <sub>CH</sub>	Operating Channel Temperature	200 °C	<u>5/ 6/</u>
	Mounting Temperature (30 Seconds)	320 °C	
T <sub>STG</sub>	Storage Temperature	-65 to 150 °C	

- 1/ These ratings represent the maximum operable values for this device.
- 2/ Combinations of supply voltage, supply current, input power, and output power shall not exceed P<sub>D</sub>.
- 3/ Total current for the entire MMIC.
- 4/ When operated at this bias condition with a base plate temperature of 70 °C, the median life is 2.3E4 hrs.
- 5/ Junction operating temperature will directly affect the device median time to failure (T<sub>m</sub>). For maximum life, it is recommended that junction temperatures be maintained at the lowest possible levels.
- 6/ These ratings apply to each individual FET.

**TABLE II  
 DC PROBE TEST  
 (TA = 25 °C)**

SYMBOL	PARAMETER	MINIMUM	MAXIMUM	UNIT
I <sub>dss (Q1A)</sub>	Saturated Drain Current	15	94	mA
G <sub>m (Q1A)</sub>	Transconductance	33	106	mS
V <sub>p (Q1)</sub>	Pinch-off Voltage	-1.5	-0.5	V
BVGS <sub> (Q1A)</sub>	Breakdown Voltage Gate-Source	-30	-8	V
BVGD <sub> (Q1A,Q1B)</sub>	Breakdown Voltage Gate-Drain	-30	-10	V

Q1A and Q1B are 150um Input FETs

**TABLE III**  
**ELECTRICAL CHARACTERISTICS**  
(Ta = 25 °C Nominal)

<b>PARAMETER</b>	<b>TYPICAL</b>	<b>UNITS</b>
Frequency Range	19 - 38	GHz
Drain Voltage, Vd	5.0	V
Drain Current, Id	160	mA
Gate Voltage, Vg	-0.6	V
Small Signal Gain, S21	20	dB
Input Return Loss, S11	11	dB
Output Return Loss, S22	8	dB
Output Power @ 1dB Gain compression, P1dB	21	dBm
Saturated Output Power, Psat	22	dBm
Output TOI @ Pin/tone = -10dBm	30	dBm
Temperature Coefficient	0.038	dB/°C

**TABLE IV  
THERMAL INFORMATION**

PARAMETER	TEST CONDITIONS	T <sub>CH</sub> (°C)	θ <sub>JC</sub> (°C/W)	T <sub>m</sub> (HRS)
θ <sub>JC</sub> Thermal Resistance (channel to Case)	V <sub>d</sub> = 5 V I <sub>d</sub> = 160 mA P <sub>diss</sub> = 0.80 W	112	51.9	3.4E+7

Note: Assumes eutectic attach using 1.5 mil 80/20 AuSn mounted to a 20 mil CuMo Carrier at 70 °C baseplate temperature. Worst case condition with no RF applied, 100% of DC power is dissipated.

**Median Lifetime (T<sub>m</sub>) vs. Channel Temperature**

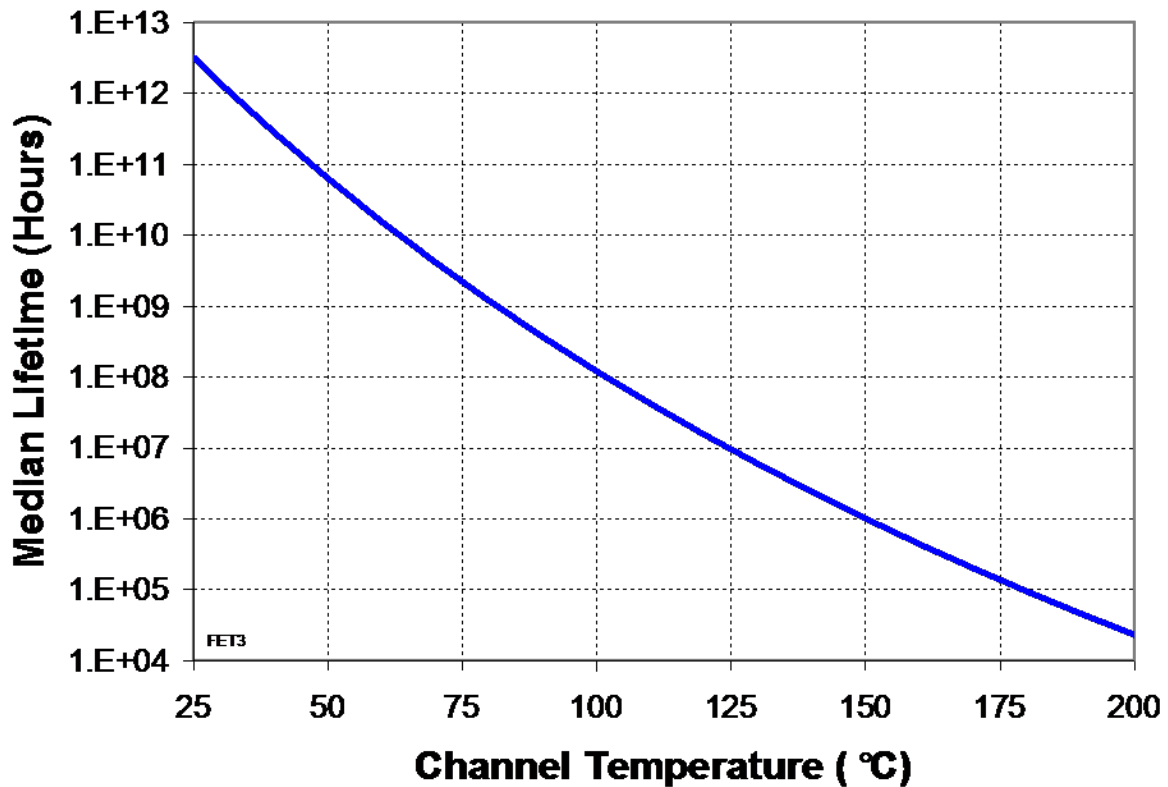

**Preliminary Measured Data**

Bias Conditions:  $V_d = 5\text{ V}$ ,  $I_{dq} = 160\text{ mA}$

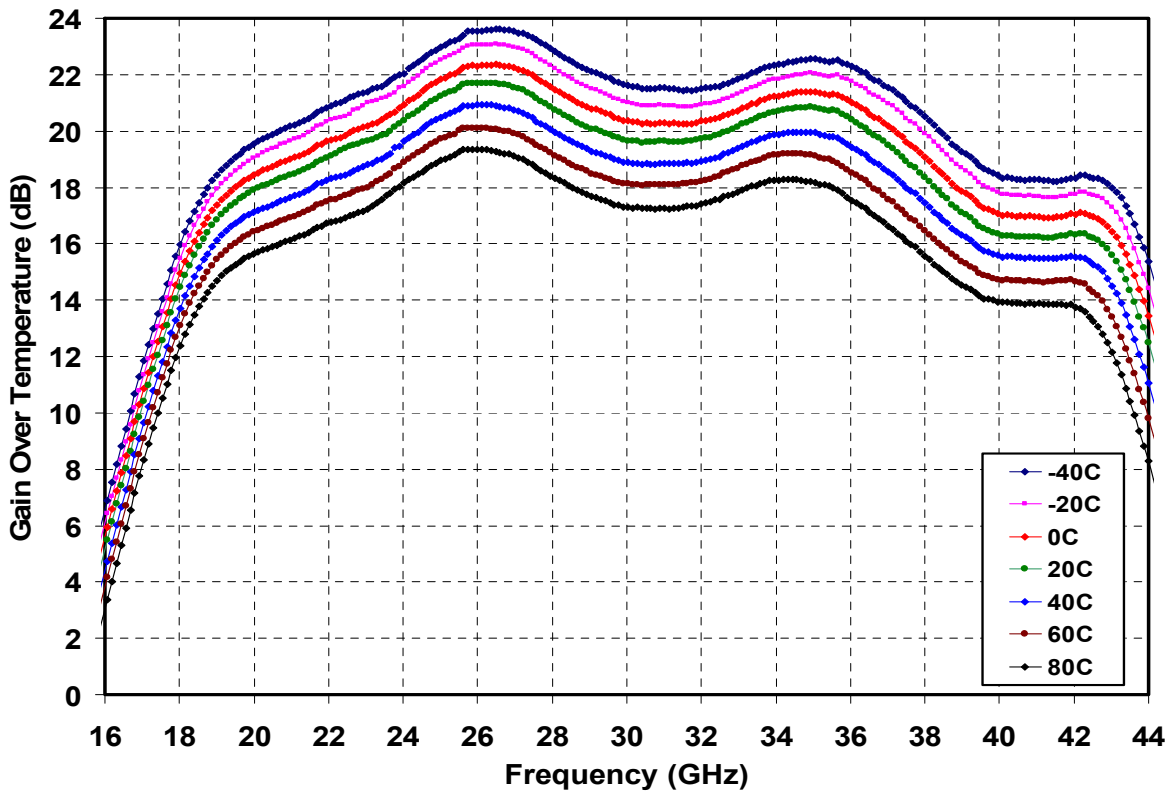
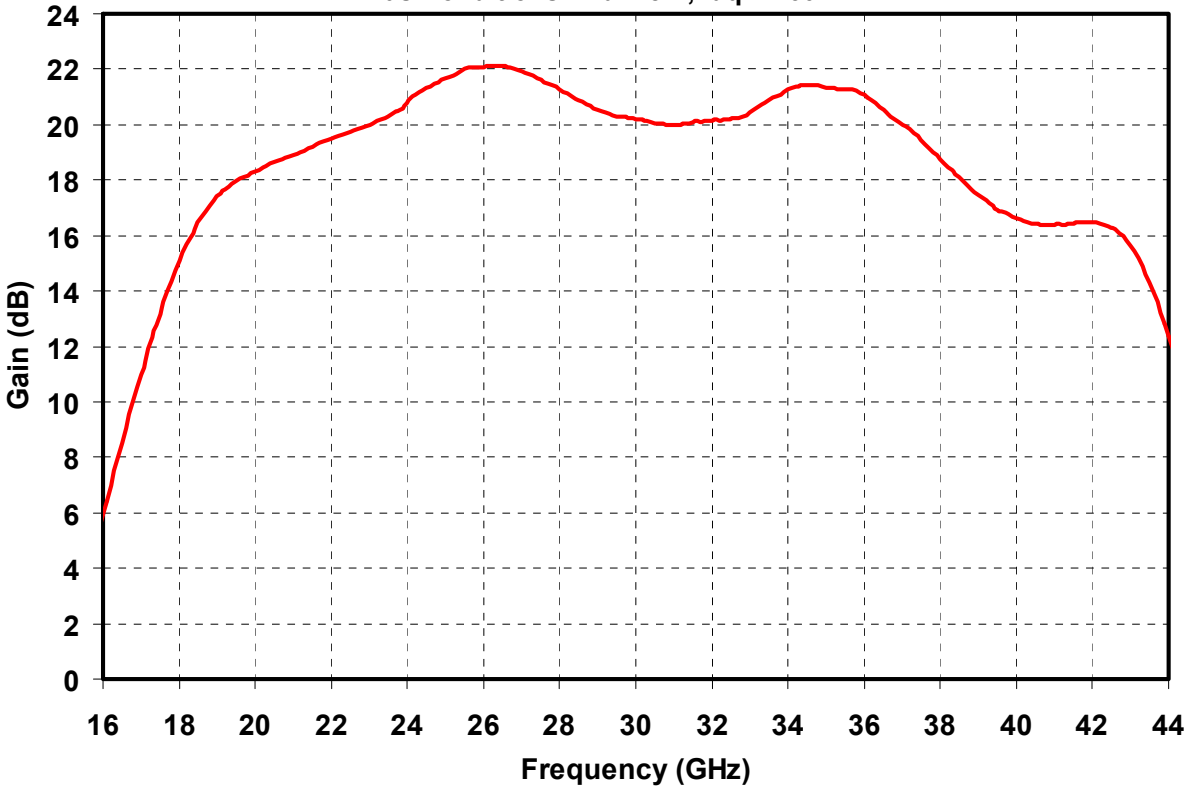

**Preliminary Measured Data**

Bias Conditions:  $V_d = 5\text{ V}$ ,  $I_{dq} = 160\text{ mA}$

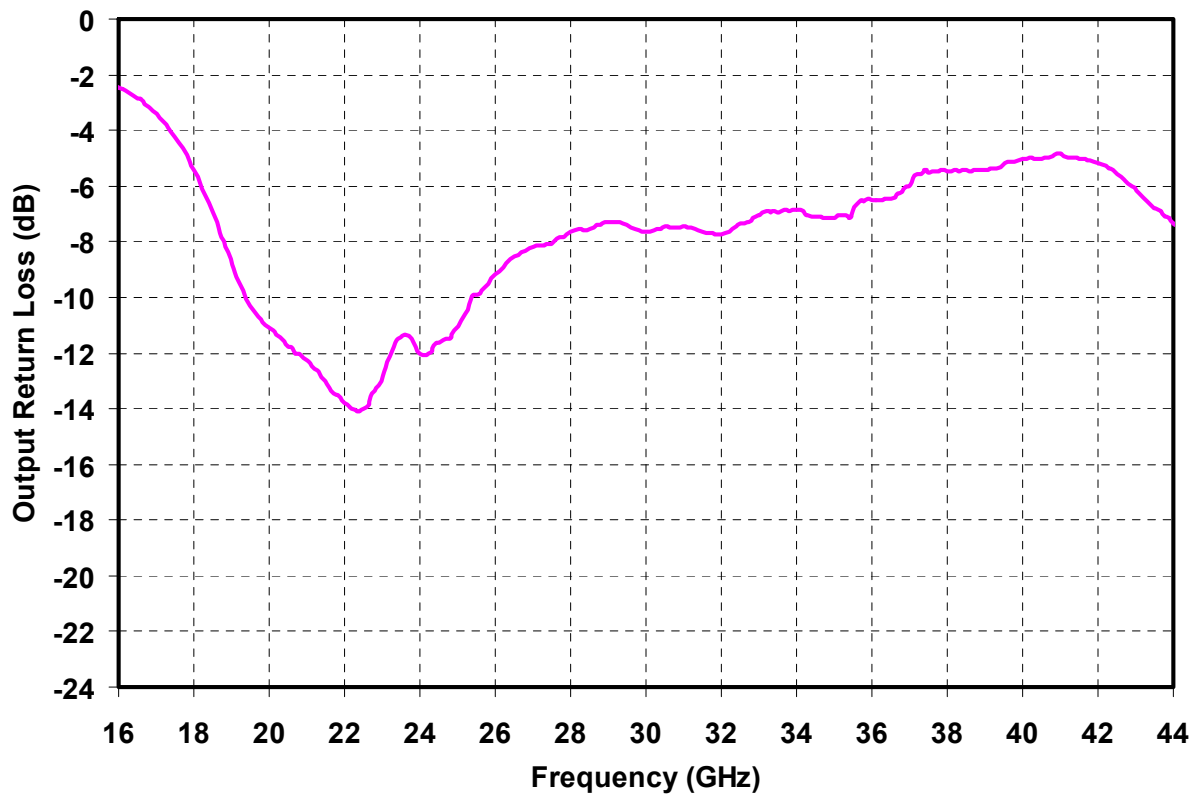
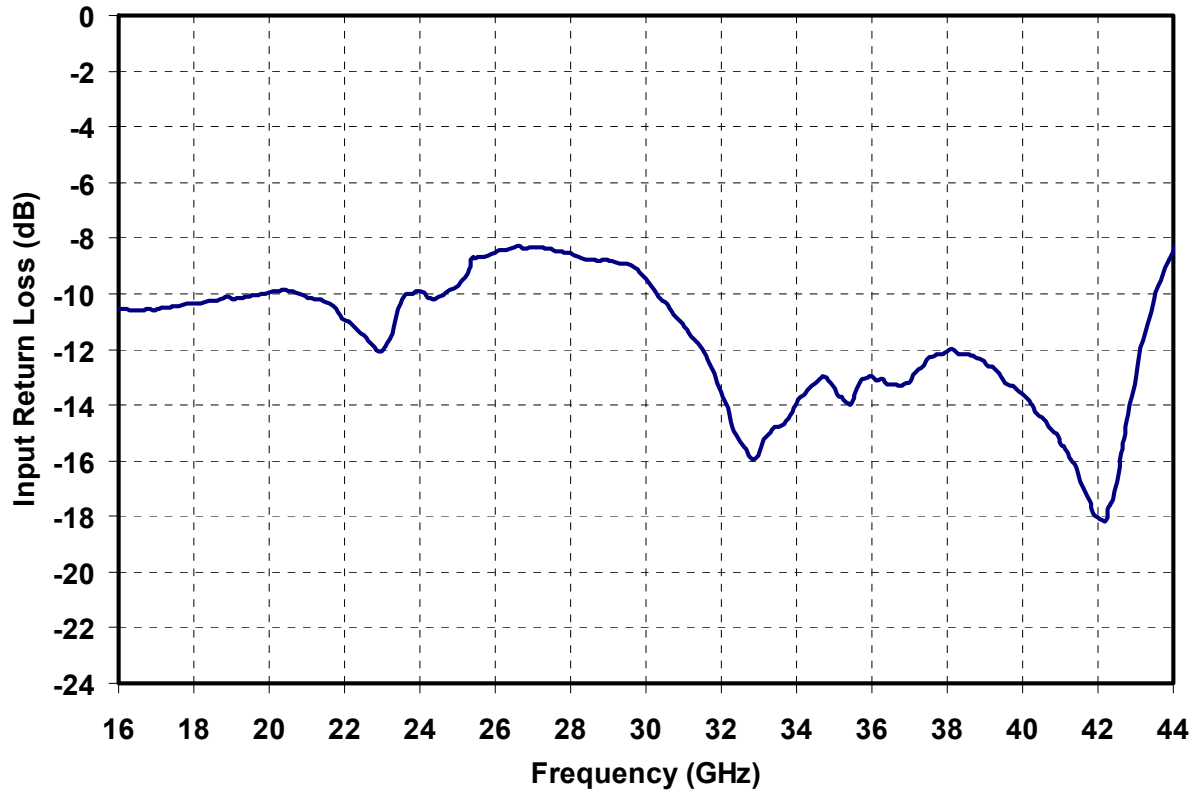

**Preliminary Measured Data**

Bias Conditions:  $V_d = 5\text{ V}$ ,  $I_{dq} = 160\text{ mA}$

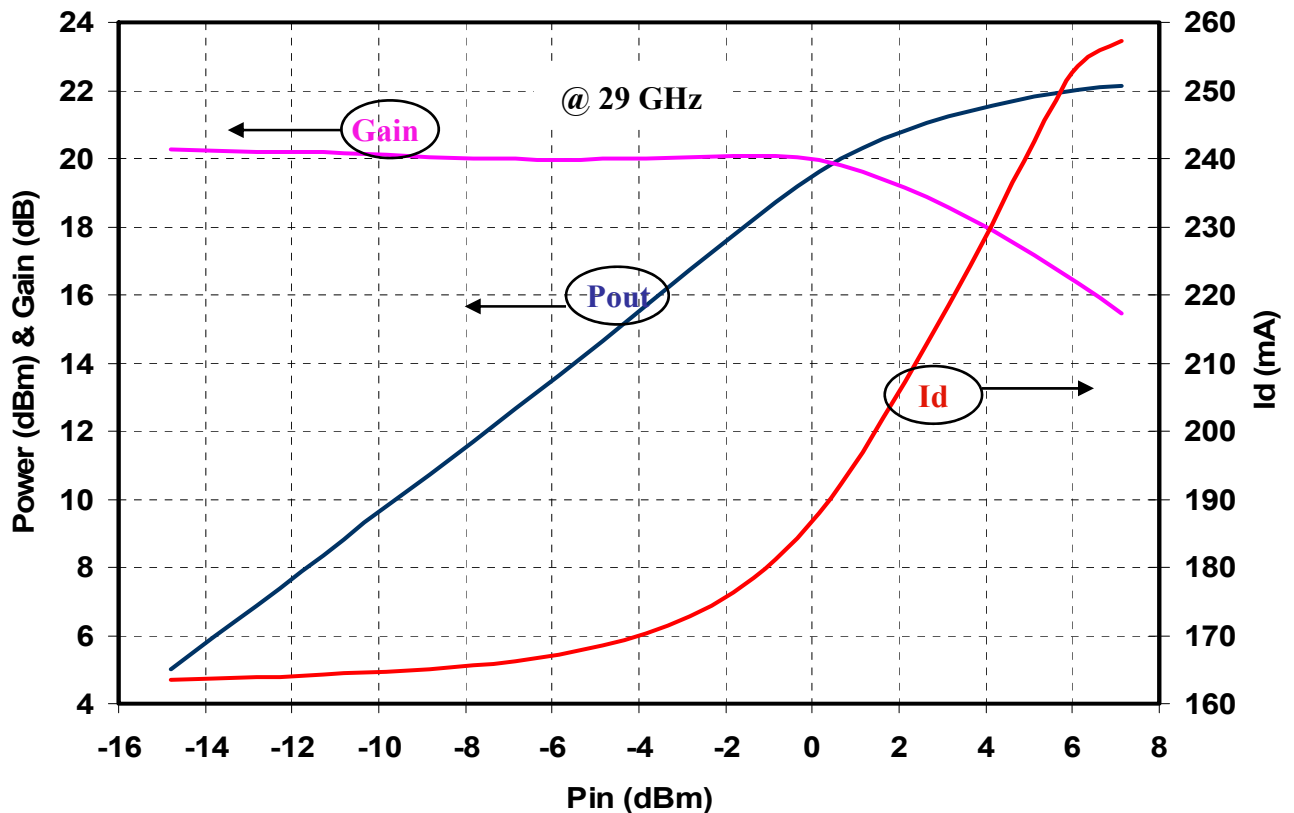
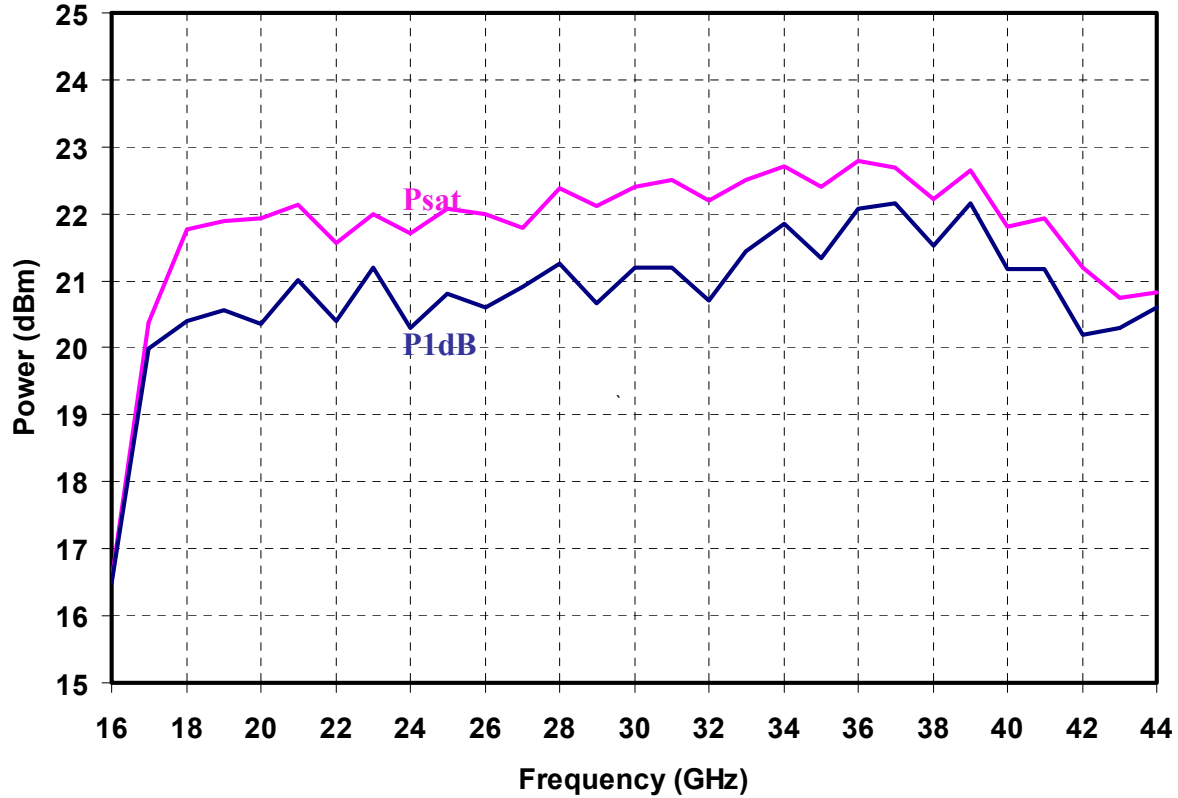

**Preliminary Measured Data**

Bias Conditions:  $V_d = 5\text{ V}$ ,  $I_{dq} = 160\text{ mA}$

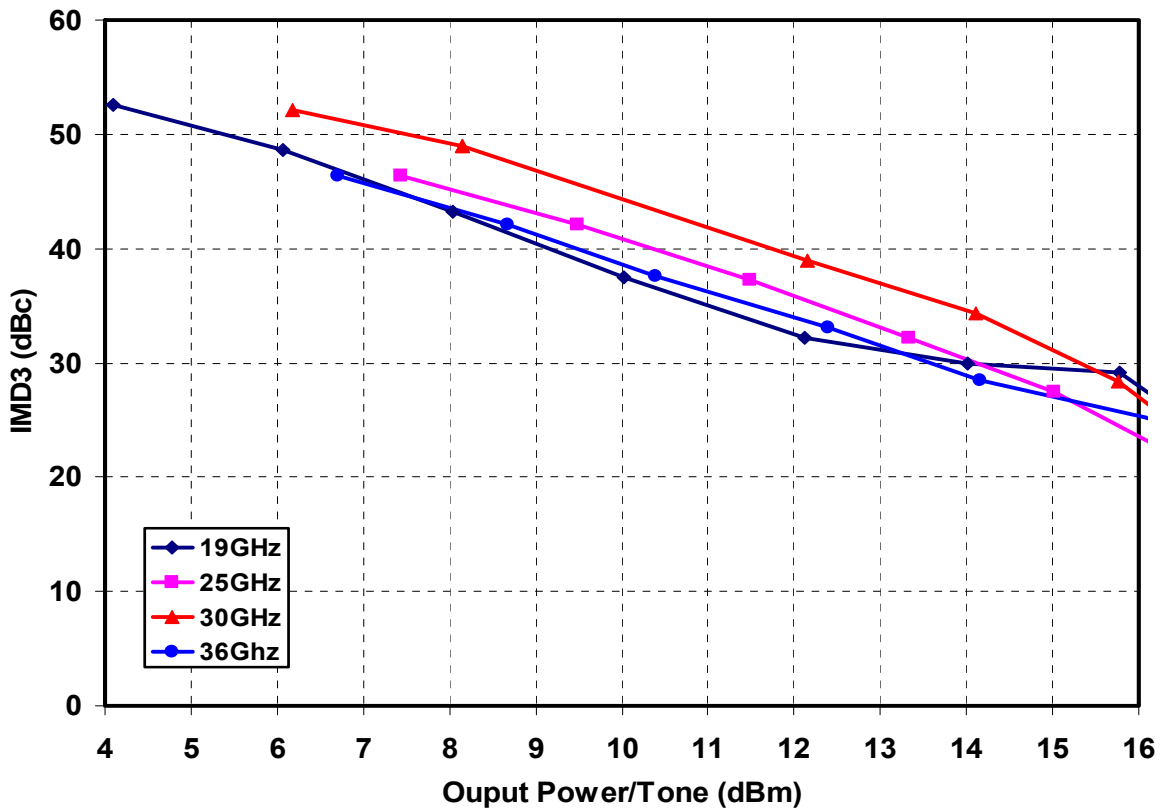
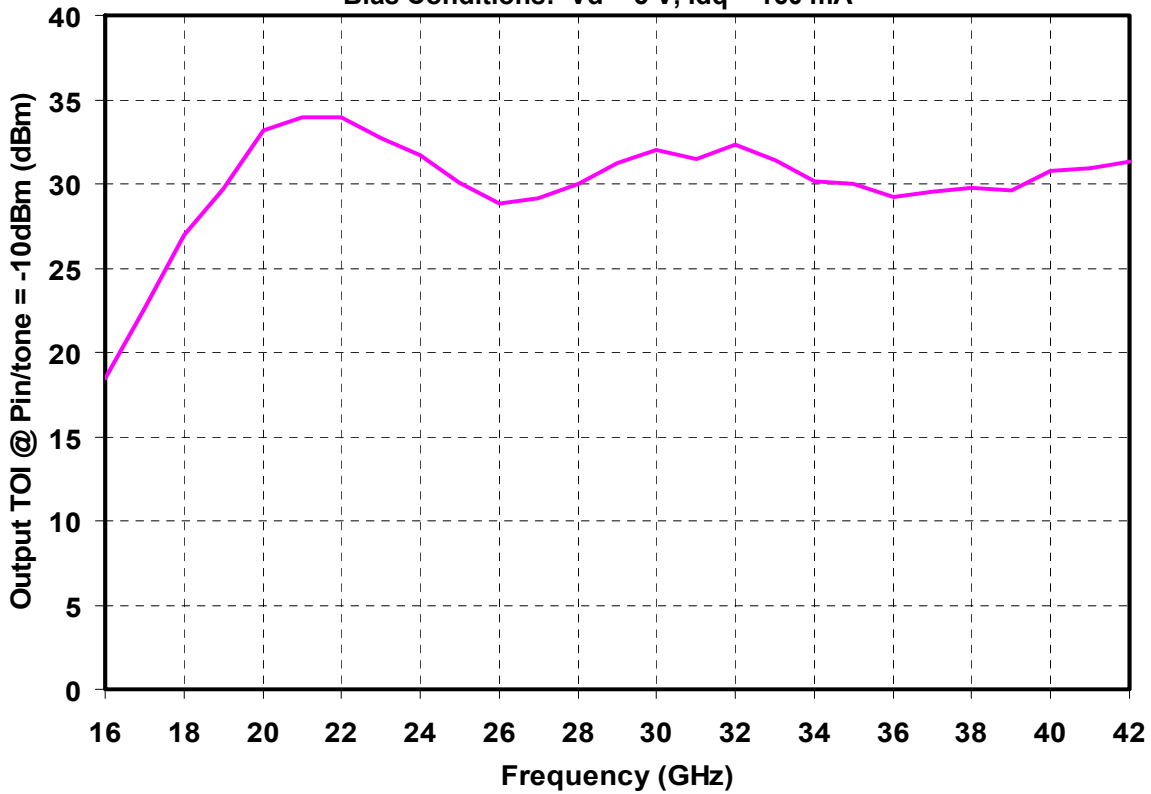



**Mechanical Drawing**

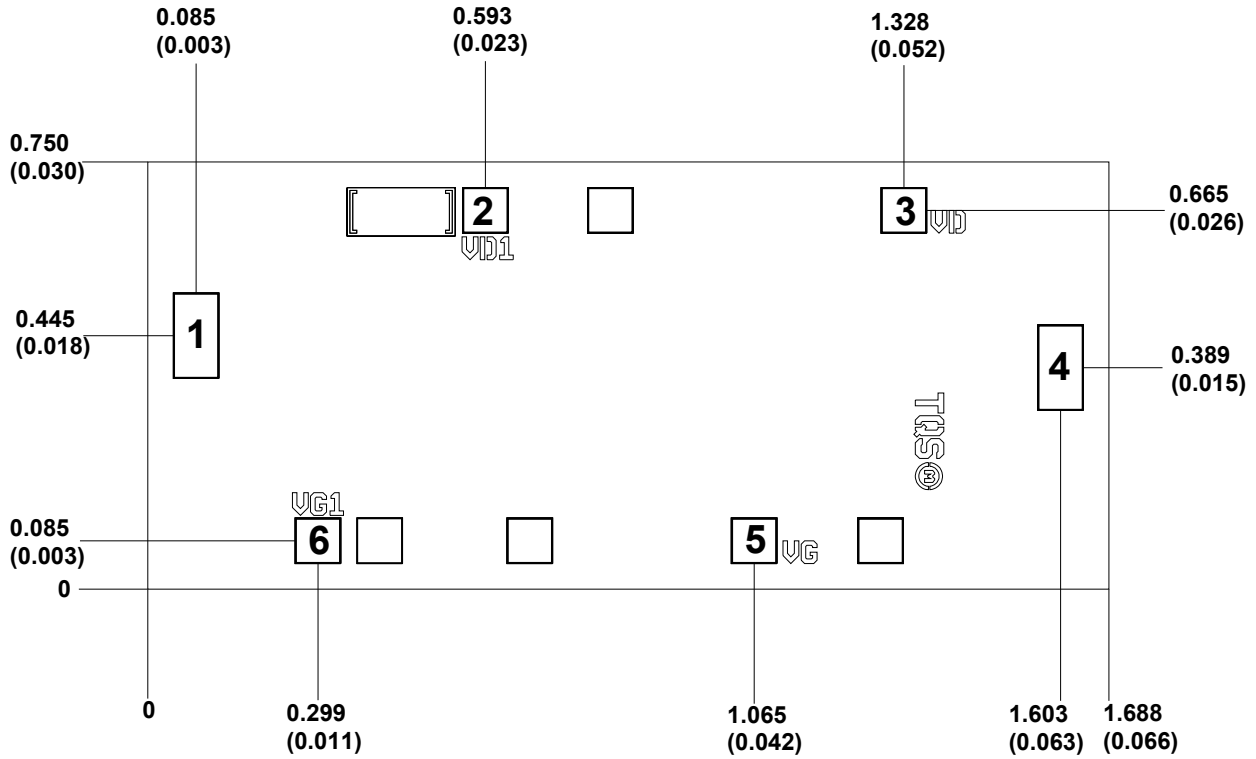

Units: Millimeters (inches)  
 Thickness: 0.100 (0.004) (Reference Only)  
 Cip edge to bond pad dimensions are shown to center of bond pad  
 Chip size tolerance: +/- 0.051 (0.002)  
 RF Ground is backside of MMIC

Bond pad #1:	(RF In)	0.080 x 0.150 (0.003 x 0.006)
Bond pad #2, #3:	(Vd)	0.080 x 0.080 (0.003 x 0.003)
Bond pad #4:	(RF Out)	0.080 x 0.150 (0.003 x 0.006)
Bond pad #5, #6:	(Vg)	0.080 x 0.080 (0.003 x 0.003)

**GaAs MMIC devices are susceptible to damage from Electrostatic Discharge. Proper precautions should be observed during handling, assembly and test.**

**Recommended Chip Assembly Diagram**

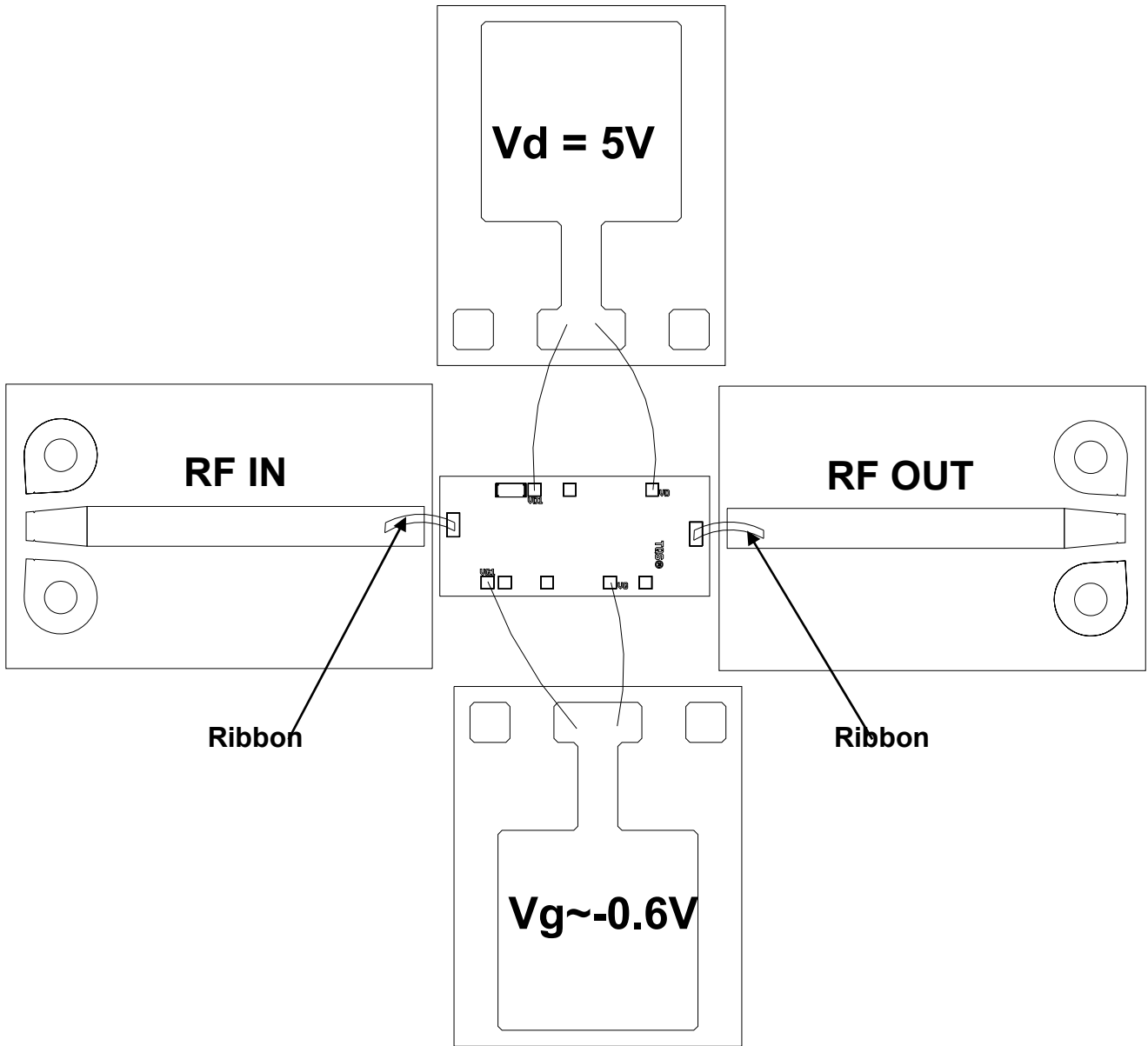

**Adjust Vg to get Id = 160mA**

***GaAs MMIC devices are susceptible to damage from Electrostatic Discharge. Proper precautions should be observed during handling, assembly and test.***

## Assembly Process Notes

Reflow process assembly notes:

- Use AuSn (80/20) solder with limited exposure to temperatures at or above 300<sup>0</sup>C (30 seconds max).
- An alloy station or conveyor furnace with reducing atmosphere should be used.
- No fluxes should be utilized.
- Coefficient of thermal expansion matching is critical for long-term reliability.
- Devices must be stored in a dry nitrogen atmosphere.

Component placement and adhesive attachment assembly notes:

- Vacuum pencils and/or vacuum collets are the preferred method of pick up.
- Air bridges must be avoided during placement.
- The force impact is critical during auto placement.
- Organic attachment can be used in low-power applications.
- Curing should be done in a convection oven; proper exhaust is a safety concern.
- Microwave or radiant curing should not be used because of differential heating.
- Coefficient of thermal expansion matching is critical.

Interconnect process assembly notes:

- Thermosonic ball bonding is the preferred interconnect technique.
- Force, time, and ultrasonics are critical parameters.
- Aluminum wire should not be used.
- Maximum stage temperature is 200<sup>0</sup>C.

***GaAs MMIC devices are susceptible to damage from Electrostatic Discharge. Proper precautions should be observed during handling, assembly and test.***

## X-ON Electronics

Largest Supplier of Electrical and Electronic Components

*Click to view similar products for [RF Amplifier](#) category:*

*Click to view products by [Qorvo](#) manufacturer:*

Other Similar products are found below :

[A82-1](#) [BGA622H6820XTSA1](#) [BGA 728L7 E6327](#) [BGB719N7ESDE6327XTMA1](#) [HMC397-SX](#) [HMC405](#) [HMC561-SX](#) [HMC8120-SX](#)  
[HMC8121-SX](#) [HMC-ALH382-SX](#) [HMC-ALH476-SX](#) [SE2433T-R](#) [SMA3101-TL-E](#) [SMA39](#) [A66-1](#) [A66-3](#) [A67-1](#) [LX5535LQ](#) [LX5540LL](#)  
[MAAM02350](#) [HMC3653LP3BETR](#) [HMC549MS8GETR](#) [HMC-ALH435-SX](#) [SMA101](#) [SMA32](#) [SMA411](#) [SMA531](#) [SST12LP19E-QX6E](#)  
[WPM0510A](#) [HMC5929LS6TR](#) [HMC5879LS7TR](#) [HMC1126](#) [HMC1087F10](#) [HMC1086](#) [HMC1016](#) [SMA1212](#) [MAX2689EWS+T](#)  
[MAAMSS0041TR](#) [MAAM37000-A1G](#) [LTC6430AIUF-15#PBF](#) [CHA5115-QDG](#) [SMA70-2](#) [SMA4011](#) [A231](#) [HMC-AUH232](#) [LX5511LQ](#)  
[LX5511LQ-TR](#) [HMC7441-SX](#) [HMC-ALH310](#) [XD1001-BD-000V](#)