

Applications

- Repeaters
- Mobile Infrastructure
- Defense/Aerospace
- LTE / WCDMA / EDGE / CDMA
- General Purpose Wireless
- IF amplifier, RF driver amplifier
- Military Communications

Product Features

- Frequency Range: 0.05 – 4.0 GHz
- NF: 1.2 dB (@ 1.9 GHz)
- Output IP3: +35 dBm (@ 1.9 GHz, 4 dBm/tone Pout)
- P1dB : +20 dBm (@1.9 GHz)
- Small Signal Gain: 20 dB (@ 1.9 GHz)
- +5V Single Supply, 85 mA Current
- Chip Dimensions: 1.49 x 0.85 x 0.085 mm

General Description

The TriQuint TGA5108 is a high linearity Low Noise Amplifier. The amplifier is fabricated using TriQuint's TQPED process. It is internally matched and only requires an external RF choke and blocking/bypass capacitors for operation from a single +5V supply. The internal active bias circuit also enables stable operation over bias and temperature variations.

The TGA5108 covers the 0.05–4.0 GHz frequency band and is targeted for wireless infrastructure or other applications requiring high linearity and/or low noise figure.

Die attach should be accomplished with conductive epoxy only. Eutectic attach is not recommended.

Lead-free and RoHS compliant

Evaluation Boards are available upon request.

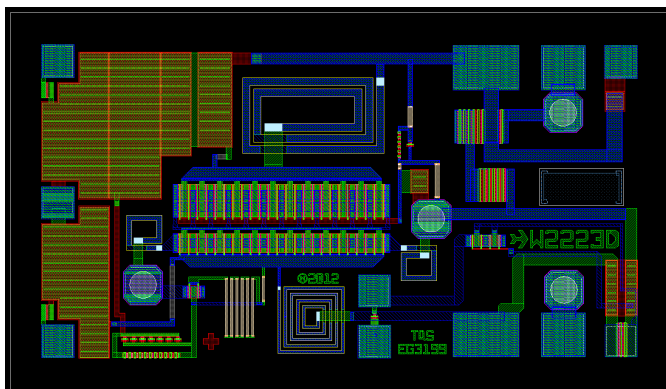

Functional Block Diagram

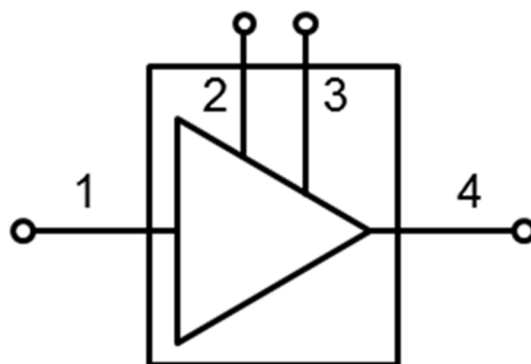

Pad Configuration

Pad No.	Symbol
1	RF Input
2	(Opt.) External Cap.
3	(Opt.) External Cap.
4	RF Output / Bias

Ordering Information

Part	ECCN	Description
TGA5108	EAR99	High Linearity LNA Gain Block

Absolute Maximum Ratings

Parameter	Value
Drain Voltage (V_D)	7.0 V
Power Dissipation, 85 °C (P_{DISS})	1.2 W
Input Power, CW, 50 Ω , $T=25$ °C (P_{IN})	23 dBm
Storage Temperature	-55 to 150 °C

Operation of this device outside the parameter ranges given above may cause permanent damage. These are stress ratings only, and functional operation of the device at these conditions is not implied.

Recommended Operating Conditions

Parameter	Value
Drain Voltage (V_D)	5 V
Drain Current (I_{DQ})	85 mA

Electrical specifications are measured at specified test conditions. Specifications are not guaranteed over all operating conditions.

Electrical Specifications

Test conditions unless otherwise noted: 25 °C, $V_D = 5$ V, tested using EVB application circuit shown on page 7

Parameter	Min	Typical	Max	Units
Operational Frequency Range	0.05	1.9	4.0	GHz
Small Signal Gain		20		dB
Input Return Loss		19		dB
Output Return Loss		16		dB
Noise Figure		1.2		dB
Output Power (1 dB Gain Compression)		20.5		dBm
Output IP3 ($P_{out}=4$ dBm/tone)		35		dBm
Gain Temperature Coefficient		-0.011		dB/°C
Noise Figure Temperature Coefficient		0.005		dB/°C

Thermal and Reliability Information

Parameter	Test Conditions	Value	Units
Thermal Resistance (θ_{JC}) ⁽¹⁾	$V_D = 5\text{ V}$, $I_{DQ} = 85\text{ mA}$, $P_{DISS} = 0.425\text{ W}$, $T_{base} = 85\text{ }^\circ\text{C}$	38.7	$^\circ\text{C/W}$
Channel Temperature (T_{CH})		101	$^\circ\text{C}$
Median Lifetime (T_M)		>1.0E7	Hrs

Notes:

1. Thermal resistance measured to back of carrier plate. MMIC mounted on 8 mils thick CDA194 carrier using 84-1 epoxy.

Median Lifetime

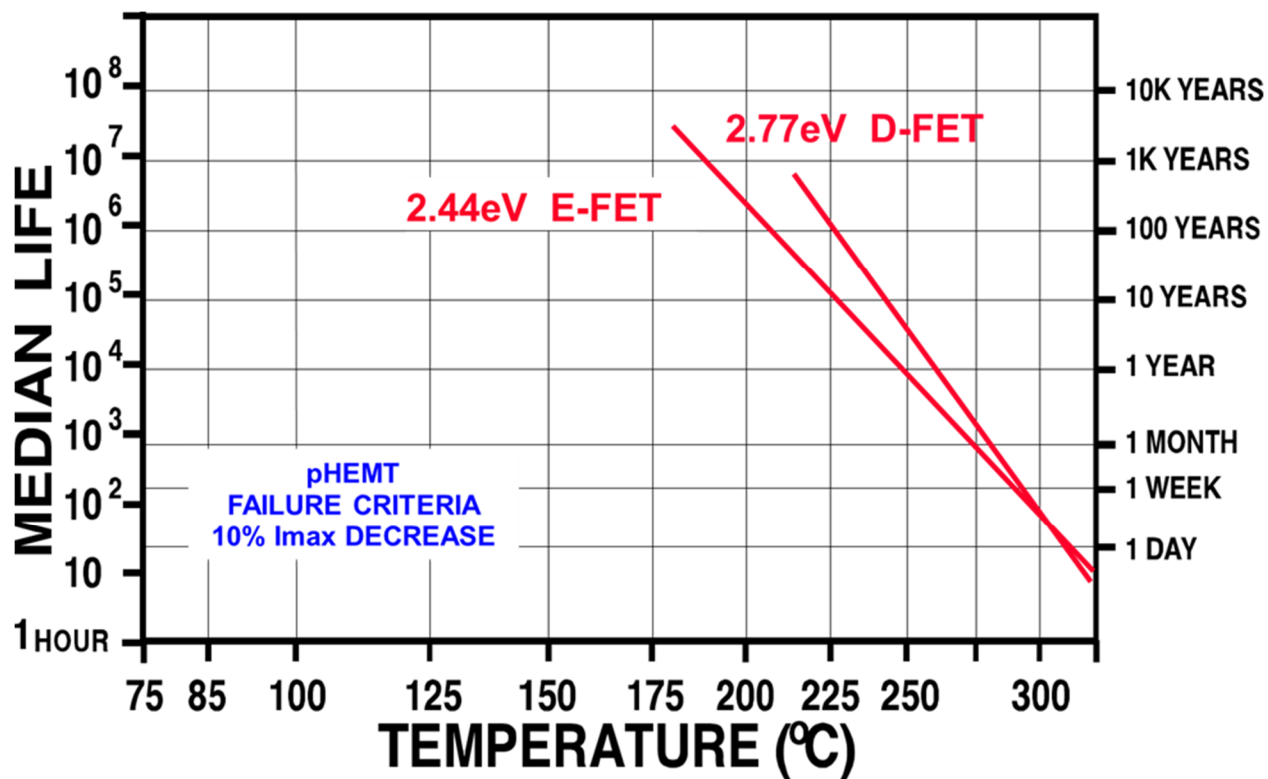

Typical Performance

Test conditions unless otherwise noted: 25 °C, $V_D = 5\text{ V}$, tested using EVB application circuit

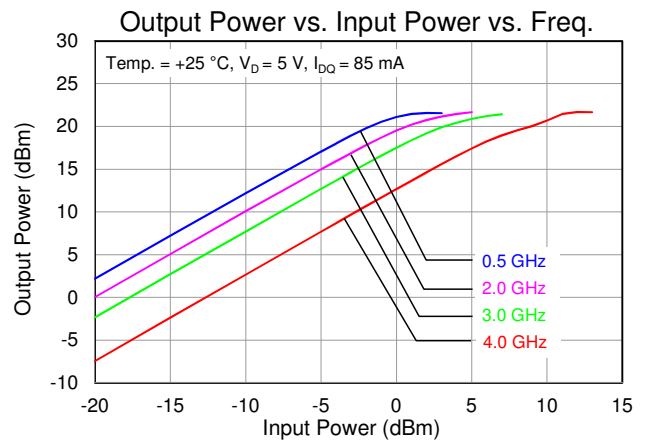
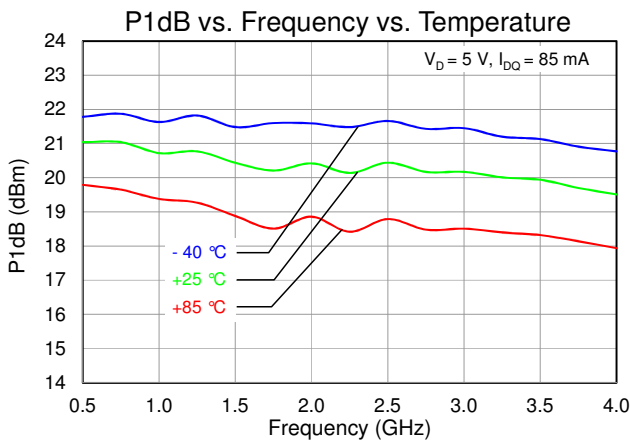
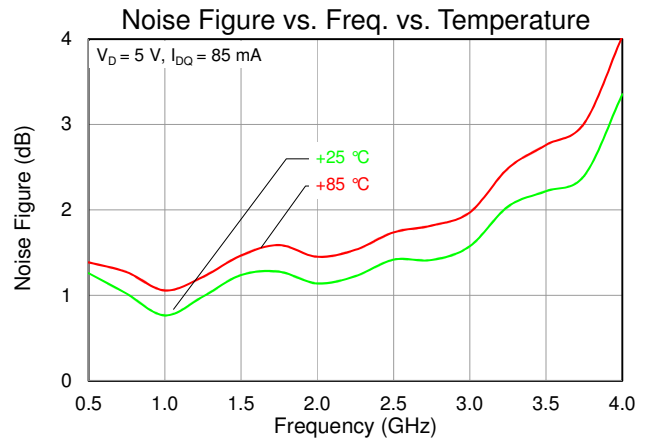
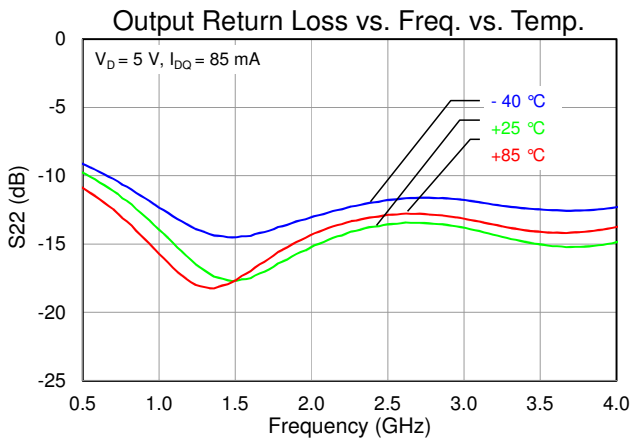
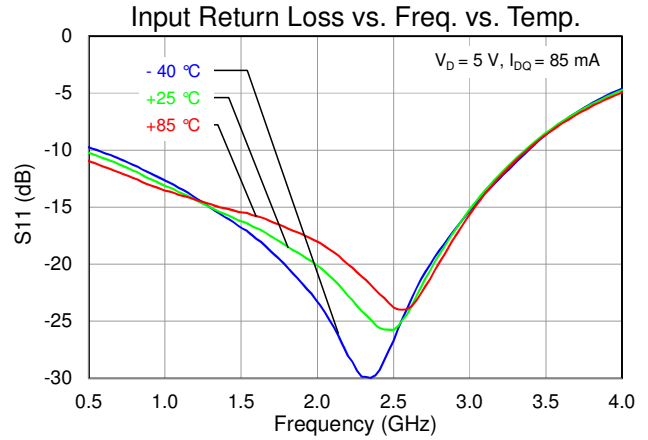
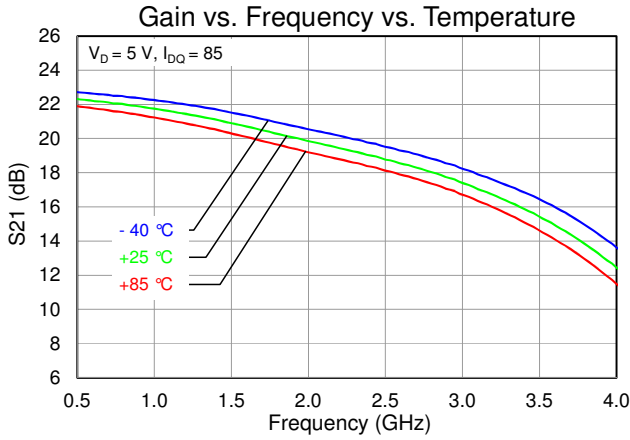

Typical Performance

Test conditions unless otherwise noted: 25 °C, $V_D = 5$ V, tested using EVB application circuit

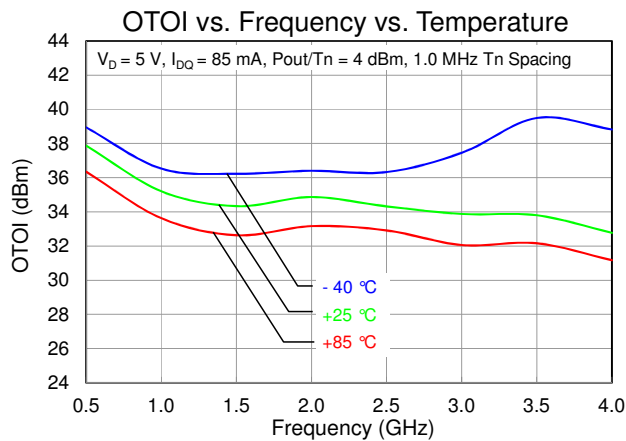
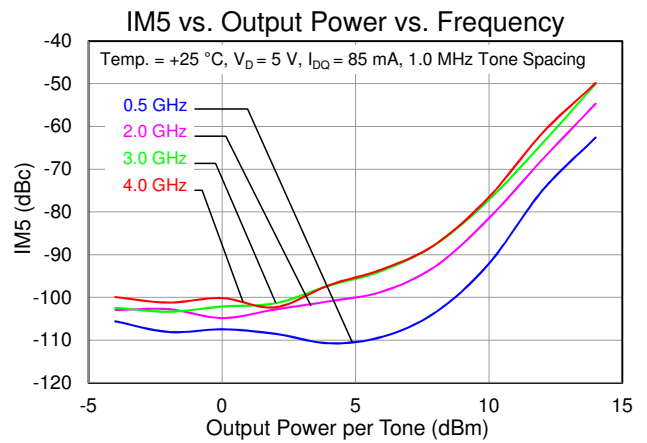
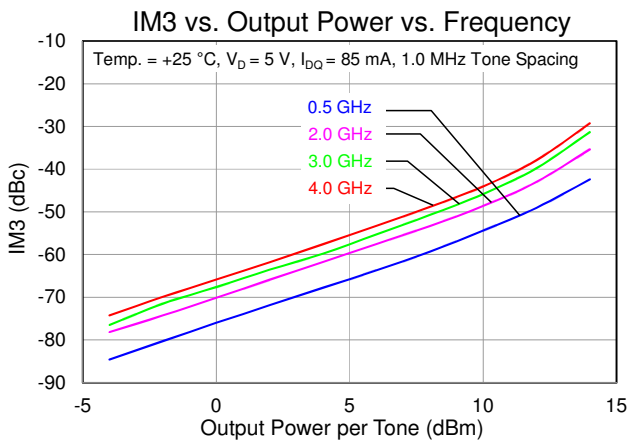
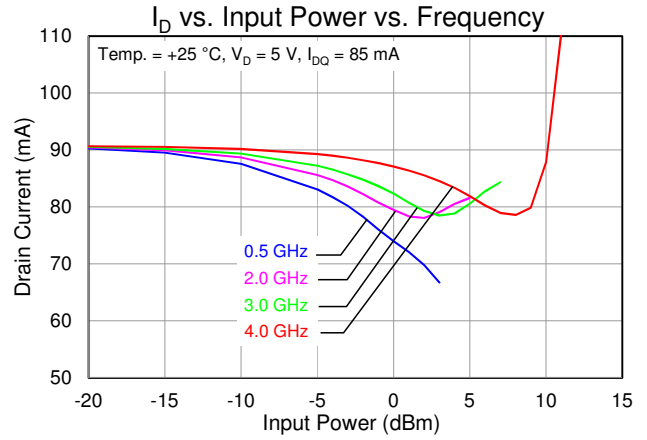
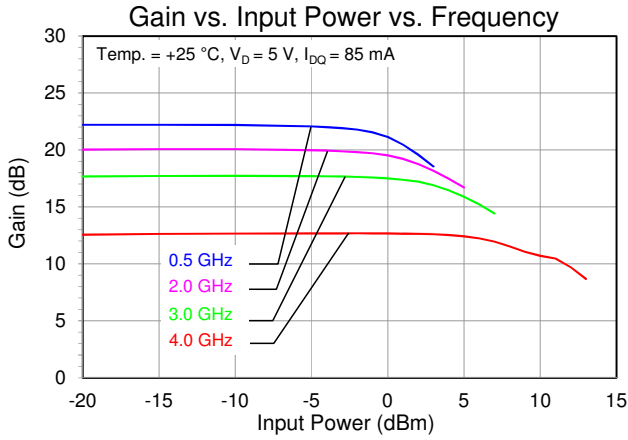

Typical Performance

Test conditions unless otherwise noted: 25 °C, $V_D = 5\text{ V}$, tested using external bias tees

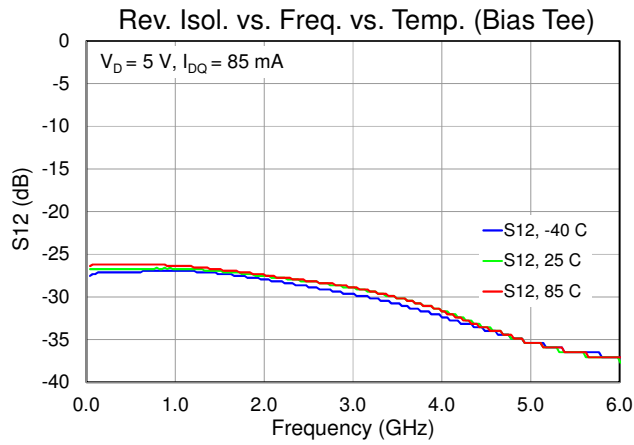
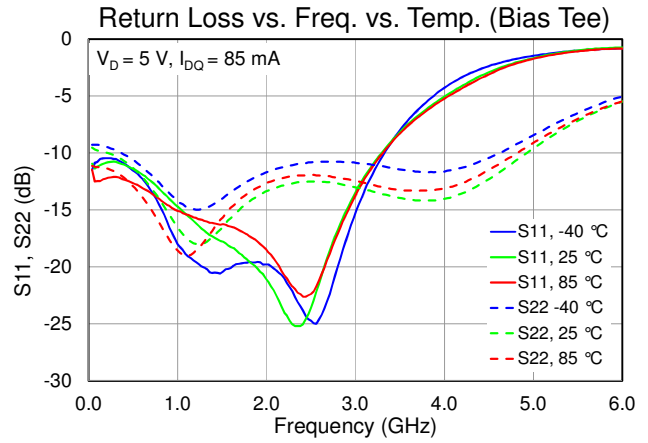
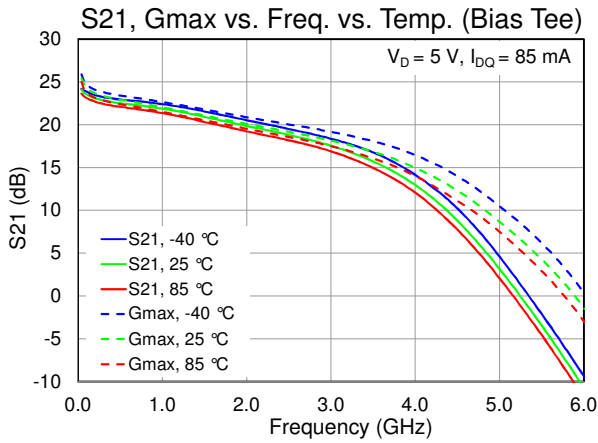

Application Circuit

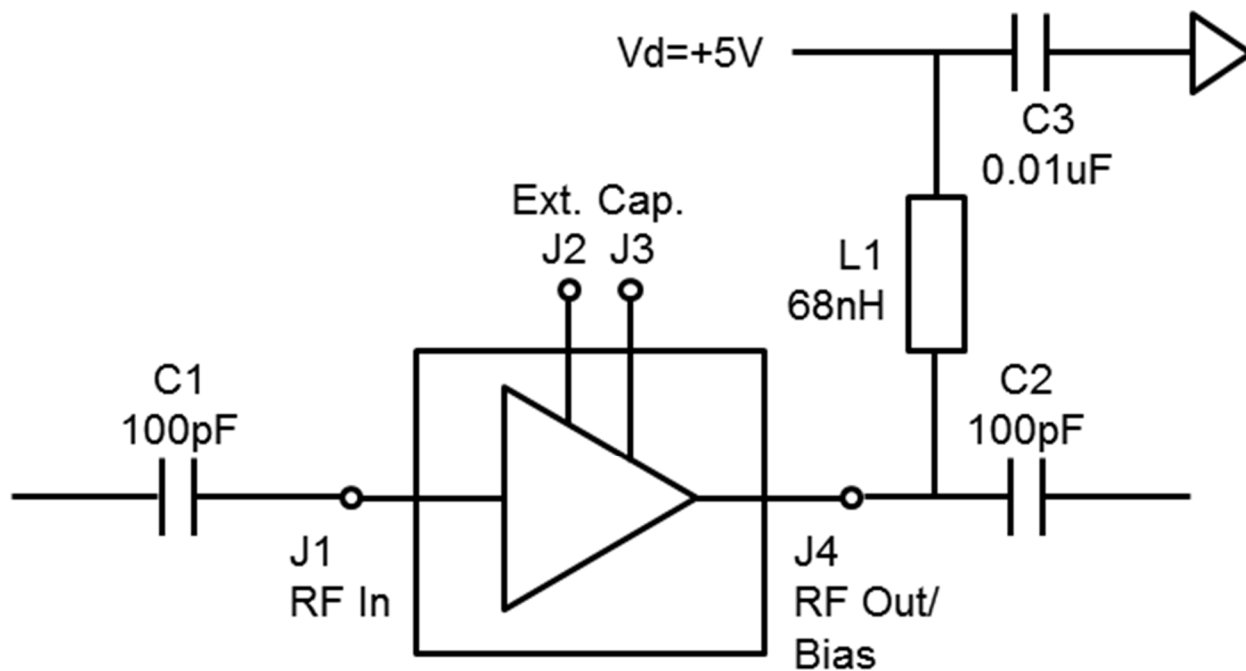

Note: Optional external capacitor can be connected between J2 and J3 to extend functional bandwidth down to 50 MHz.

Bias-up Procedure

1. Set I_D limit to 140 mA, set V_D to 0 V
2. Apply +5 V to RF Output/Bias (part self-biases to appropriate I_{ds} value)
3. Apply RF signal

Bias-down Procedure

1. Turn off RF signal
2. Reduce V_D to 0 V
3. Turn off V_D supply

Assembly Drawing

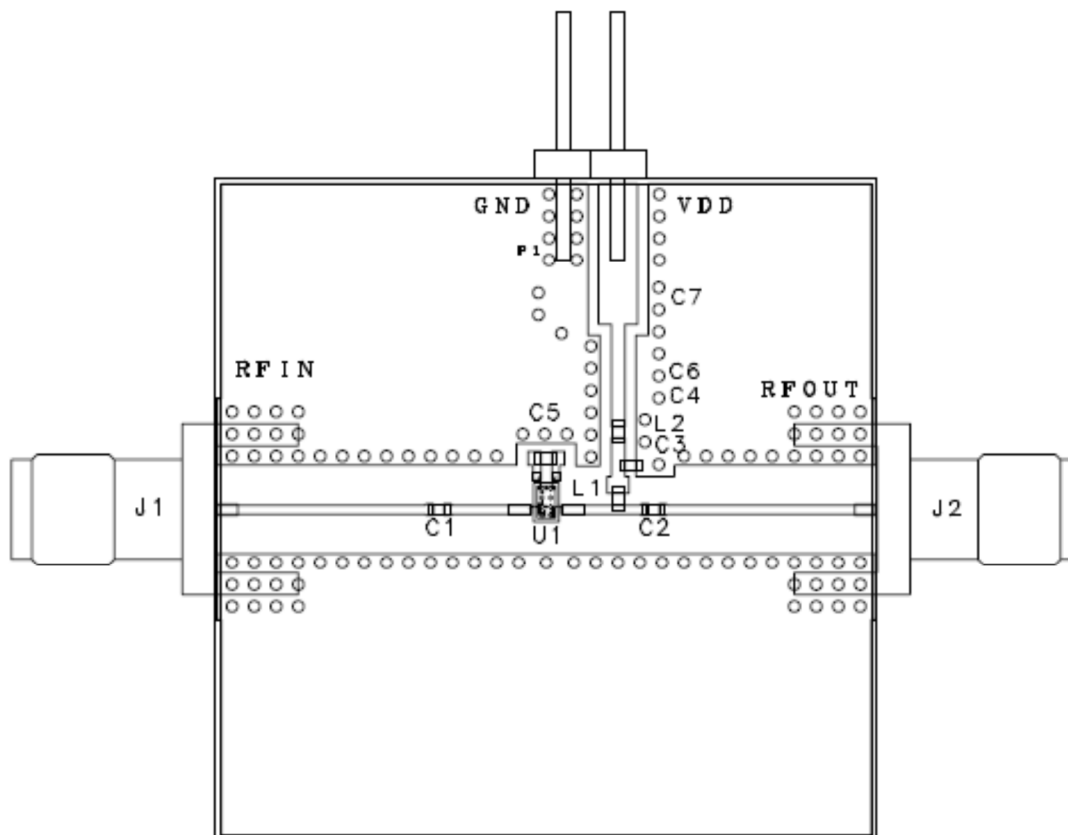

Notes:

1. PCB material: Rogers 4003, 8 mil thick, 0.5 oz. copper.
2. RF Connector: Gigalane PSF-S01 SMA
3. 0402 Components: C1,C2=100pF, L1=68 nH coil, L2=0 Ohm Jumper, C3=0.01uF
4. Capacitor C5 can be added to extend the low frequency cutoff to 50 MHz. Customer to optimize the capacitor value.

Mechanical Drawing

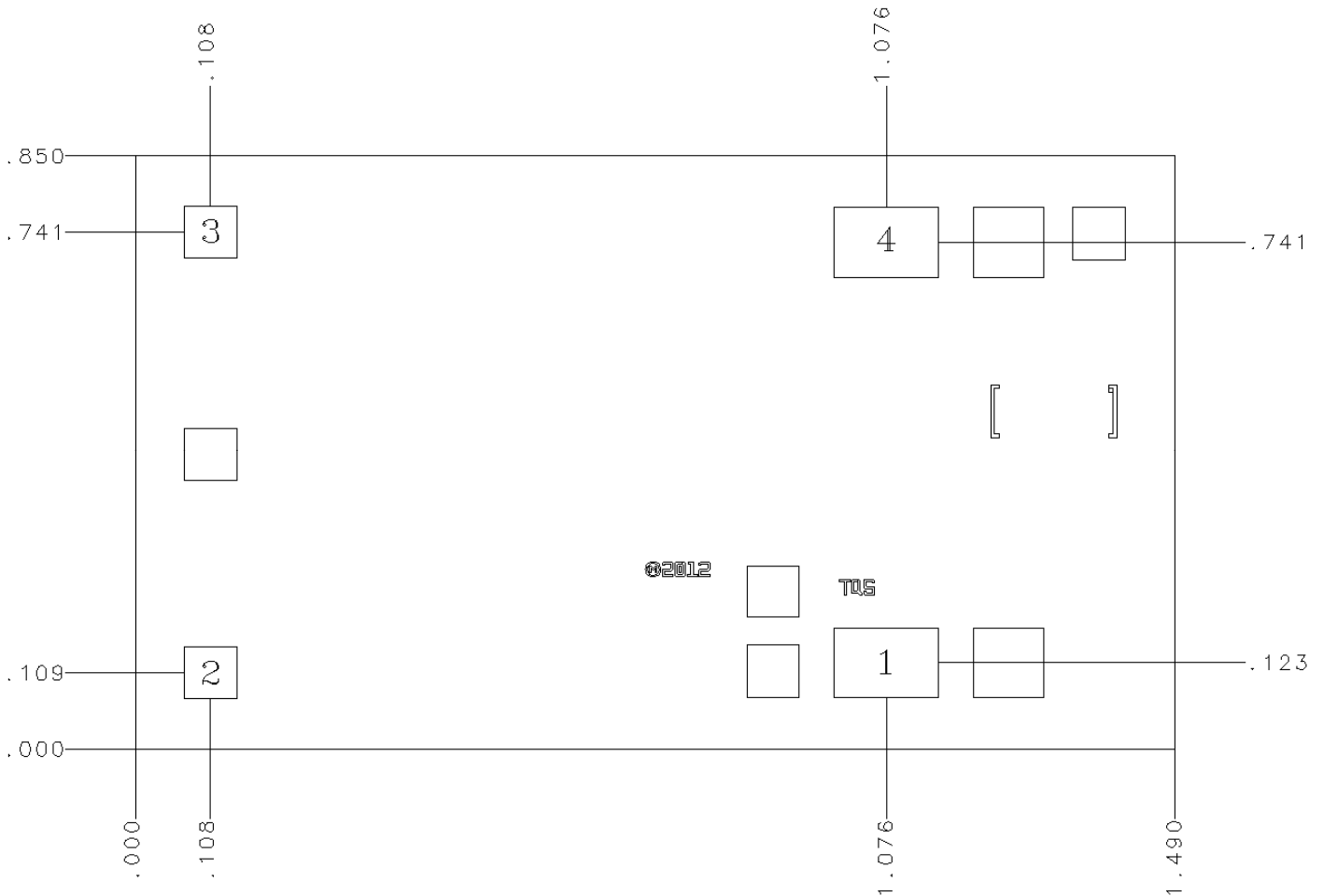

Unit: millimeters
 Thickness: 0.085
 Die x, y size tolerance: +/- 0.050
 Chip edge to bond pad dimensions are shown to center of pad
 Ground is backside of die

Bond Pad	Symbol	Pad Size (mm)	Description
1	RF Input	0.150 x 0.100	RFInput matched to 50 Ohms, not DC blocked
2	(Opt.) Ext. Cap	0.075 x 0.075	Connect ext. cap to increase lower end bandwidth
3	(Opt.) Ext. Cap	0.075 x 0.075	Connect ext. cap to increase lower end bandwidth
4	RF Output/Bias	0.150 x 0.100	RFOutput matched to 50 Ohms, not DC blocked, apply device bias

Assembly Notes

Component placement and adhesive attachment assembly notes:

- Vacuum pencils and/or vacuum collets are the preferred method of pick up.
- The force impact is critical during auto placement.
- Organic attachment (i.e. epoxy) can be used in low-power applications.
- Curing should be done in a convection oven; proper exhaust is a safety concern.

Interconnect process assembly notes:

- Thermosonic ball bonding is the preferred interconnect technique.
- Force, time, and ultrasonics are critical parameters.
- Aluminum wire should not be used.
- Devices with small pad sizes should be bonded with 0.0007-inch wire.

Product Compliance Information

ESD Sensitivity Ratings



Caution! ESD-Sensitive Device

ESD Rating: Class 1A
Value: Passes ≥ 250 V to < 500 V
Test: Human Body Model (HBM)
Standard: JEDEC Standard JESD22-A114

ECCN

US Department of Commerce: EAR99

Die Attach

Die attach should be accomplished with conductive epoxy only. Eutectic attach is not recommended.

RoHS Compliance

This product also has the following attributes:

- Lead Free
- Halogen Free (Chlorine, Bromine)
- Antimony Free
- TBBP-A (C₁₅H₁₂Br₄O₂) Free
- PFOS Free
- SVHC Free

Contact Information

For the latest specifications, additional product information, worldwide sales and distribution locations, and information about TriQuint:

Web: www.triquint.com
Email: info-sales@triquint.com

Tel: +1.972.994.8465
Fax: +1.972.994.8504

For technical questions and application information: Email: info-products@triquint.com

Important Notice

The information contained herein is believed to be reliable. TriQuint makes no warranties regarding the information contained herein. TriQuint assumes no responsibility or liability whatsoever for any of the information contained herein. TriQuint assumes no responsibility or liability whatsoever for the use of the information contained herein. The information contained herein is provided "AS IS, WHERE IS" and with all faults, and the entire risk associated with such information is entirely with the user. All information contained herein is subject to change without notice. Customers should obtain and verify the latest relevant information before placing orders for TriQuint products. The information contained herein or any use of such information does not grant, explicitly or implicitly, to any party any patent rights, licenses, or any other intellectual property rights, whether with regard to such information itself or anything described by such information.

TriQuint products are not warranted or authorized for use as critical components in medical, life-saving, or life-sustaining applications, or other applications where a failure would reasonably be expected to cause severe personal injury or death.

X-ON Electronics

Largest Supplier of Electrical and Electronic Components

Click to view similar products for [RF Amplifier](#) category:

Click to view products by [Qorvo](#) manufacturer:

Other Similar products are found below :

[A82-1](#) [BGA622H6820XTSA1](#) [BGA 728L7 E6327](#) [BGB719N7ESDE6327XTMA1](#) [HMC397-SX](#) [HMC405](#) [HMC561-SX](#) [HMC8120-SX](#)
[HMC8121-SX](#) [HMC-ALH382-SX](#) [HMC-ALH476-SX](#) [SE2433T-R](#) [SMA3101-TL-E](#) [SMA39](#) [A66-1](#) [A66-3](#) [A67-1](#) [LX5535LQ](#) [LX5540LL](#)
[MAAM02350](#) [HMC3653LP3BETR](#) [HMC549MS8GETR](#) [HMC-ALH435-SX](#) [SMA101](#) [SMA32](#) [SMA411](#) [SMA531](#) [SST12LP19E-QX6E](#)
[WPM0510A](#) [HMC5929LS6TR](#) [HMC5879LS7TR](#) [HMC1126](#) [HMC1087F10](#) [HMC1086](#) [HMC1016](#) [SMA1212](#) [MAX2689EWS+T](#)
[MAAMSS0041TR](#) [MAAM37000-A1G](#) [LTC6430AIUF-15#PBF](#) [CHA5115-QDG](#) [SMA70-2](#) [SMA4011](#) [A231](#) [HMC-AUH232](#) [LX5511LQ](#)
[LX5511LQ-TR](#) [HMC7441-SX](#) [HMC-ALH310](#) [XD1001-BD-000V](#)