

Product Description

The QORVO TGC2510-SM is a Ku-Band image reject upconverter with integrated LO buffer amplifier and output variable gain amplifier. The TGC2510-SM operates from an RF of 10 to 16 GHz and LO from 6.5 to 19 GHz with IF inputs from DC to 3.5GHz and is designed using QORVO's 3MI DR 0.15 um pHEMT production process.

The TGC2510-SM typically provides 33 dBm of output TOI at -10 dBm input power per tone and has a conversion gain of 17 dB.

The TGC2510-SM is available in a low-cost, surface mount 28 lead 5x5mm QFN package and is ideally suited for Point-to-Point Radio, and Ku-Band VSAT Ground Terminal.

Lead-free and RoHS compliant.

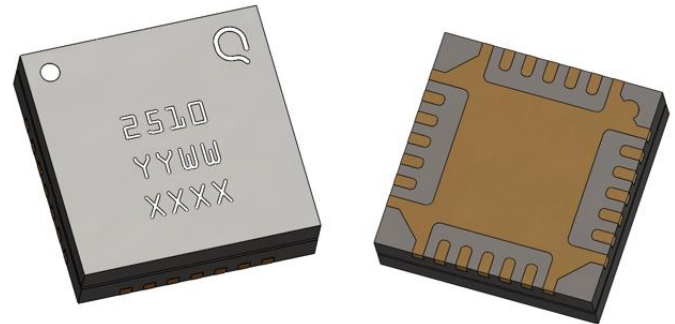

28-pin 5x5 mm QFN package

Product Features

- RF Frequency Range: 10 - 16 GHz
- IF Frequency: DC – 3.5 GHz
- LO Frequency: 6.5 – 19 GHz
- LO Input Power: 0 to 6 dBm
- Conversion Gain: 17 dB
- OTOI: 33 dBm at max gain
- Attenuation Range: 15 dB typical
- Package Dimensions: 5.0 x 5.0 x 1.3 mm

Performance is typical across frequency. Please reference electrical specification table and data plots for more details.

Function Block Diagram

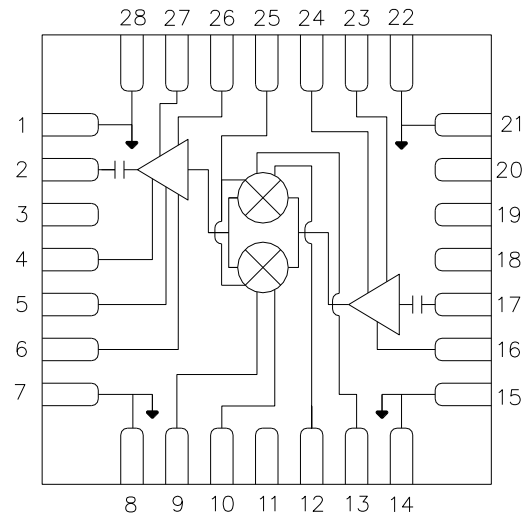

Ordering Information

Part No.	Description
TGC2510-SM	Ku-Band Upconverter
TGC2510-SMEVBLL	TGC2510-SM EVB LSB, Low IF Band, 1.3 to 2.45 GHz
TGC2510-SMEVBLH	TGC2510-SM EVB LSB, High IF Band, 2.5 to 4.0 GHz
TGC2510-SMEVBUL	TGC2510-SM EVB USB, Low IF Band, 1.3 to 2.45 GHz
TGC2510-SMEVBUH	TGC2510-SM EVB USB, High IF Band, 2.5 to 4.0 GHz

Applications

- VSAT
- Point-to-Point Radio
- Test Equipment & Sensors

Absolute Maximum Ratings

Parameter	Rating
VDRF	6 V
VDLO	6 V
IDRF	350 mA
IDLO	100 mA
VREF	3 V
VGRF, VGLO, VGX	-2 to +1.5 V
VCTRL	3 V
IF1, IF2	-2 to +2 V
IF Input Power, 50Ω, T = 25°C	10 dBm
Channel Temperature, T _{ch}	200 °C
Storage Temperature	-65 to 125°C

These are stress ratings only, functional operation of the device at these conditions is not implied. Extended application of Absolute Maximum Rating conditions may reduce device reliability. Operation of this device outside the parameter ranges given above may cause permanent damage.

Recommended Operating Conditions

Parameter	Min	Typ.	Max	Units
Operating Temp. Range	-40	+25	+85	°C
VDRF		5		V
IDRF		240		mA
VGRF		-0.70		V
VDLO		5		V
IDLO		60		mA
VGLO		-0.63		V
VREF		2		V
VGX		-1.2		V
VCTRL		0		V
LO Input Power	0		6	dBm

Electrical specifications are measured at specified test conditions. Specifications are not guaranteed over all recommended operating conditions.

Electrical Specifications

Test conditions unless otherwise noted: IF Input Power = -10 dBm, VGX = -1.2 V, VREF = 2 V, VDLO = 5 V, IDLO = 60 mA, VDRF = 5 V, IDRF = 240 mA. VCTRL = 0 V for maximum gain.

Parameter	Conditions	Min	Typ	Max	Units
RF Frequency Range		10		16	GHz
LO Frequency Range		6.5		19	GHz
IF Frequency Range		DC		3.5	GHz
LO Input Power		0		6	dBm
Conversion Gain	IF=2GHz	15	17		dBm
Third Order Output Intercept Point, OIP3	RF = 10 to 11.7GHz, IF=2GHz	24	33		dBm
Third Order Output Intercept Point, OIP3	RF = 12.7 to 15.4GHz, IF=2GHz	26	33		dBm
Image Rejection			25		dB
P1dB Output Power			22		dBm

Thermal and Reliability Information

Parameter	Conditions	Rating
Thermal Resistance, θ_{JC} , measured to back of package	Tbase = 85 °C	θ_{JC} = 26.1 °C/W
Channel Temperature (Tch), and Median Lifetime (Tm)	Tbase = 85 °C, VDRF = 5 V, IDRF = 240 mA VDLO = 5 V, IDLO = 60 mA Pdis = 1.5 W	Tch = 124 °C Tm = 2.3 E+7 Hours
Channel Temperature (Tch), and Median Lifetime (Tm) Under RF Drive	Tbase = 85 °C VDRF = 5 V, IDRF = 240 mA VDLO = 5 V, IDLO = 85 mA Pin = -10 dBm Pdis = 1.63 W	Tch = 128 °C Tm = 1.4 E+7 Hours

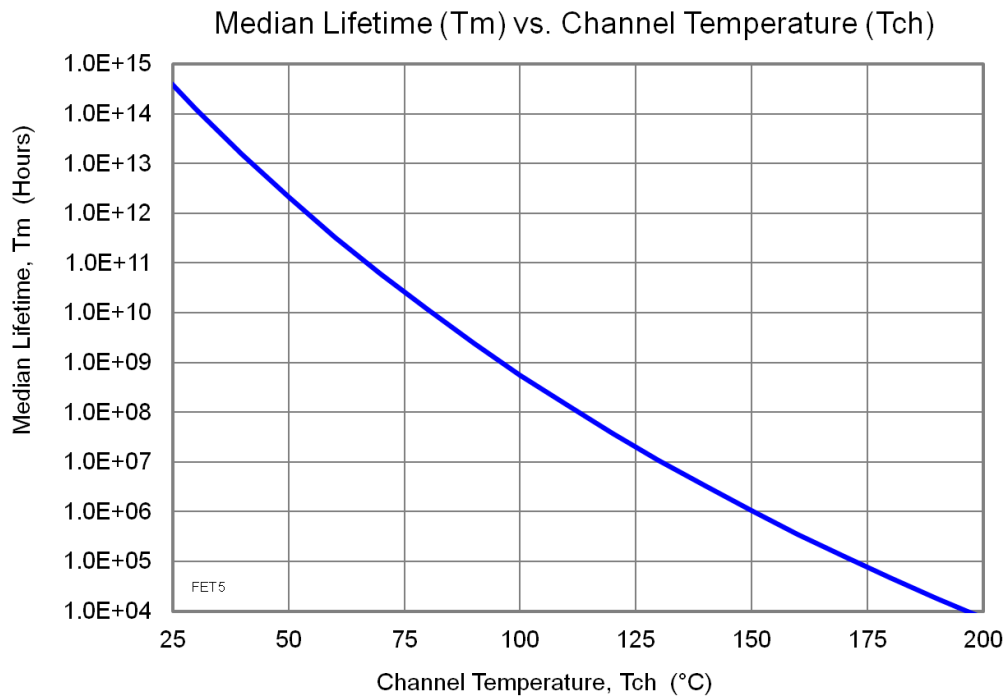

Performance Plots

IF Input Power = -10 dBm, VDLO = 5 V, IDLO = 60 mA, VDRF = 5 V, IDRf = 240 mA. VGX = -1.2 V, VREF = 2 V.
 Data taken with external IF hybrid and LO nulling applied.

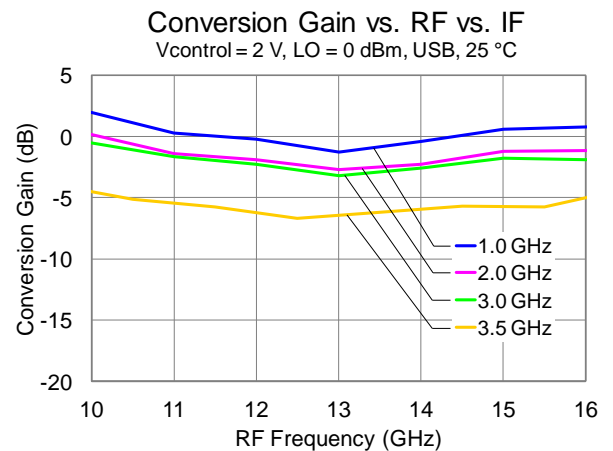
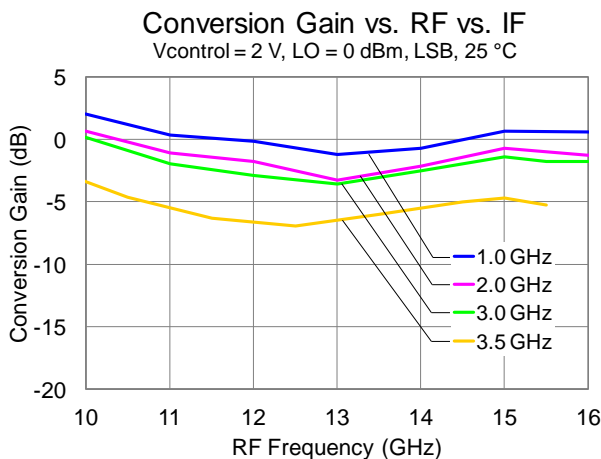
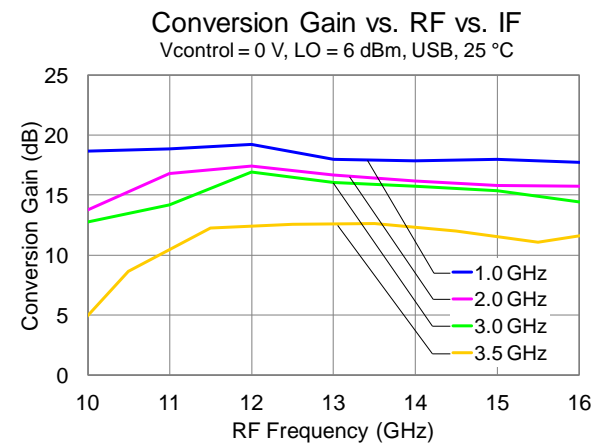
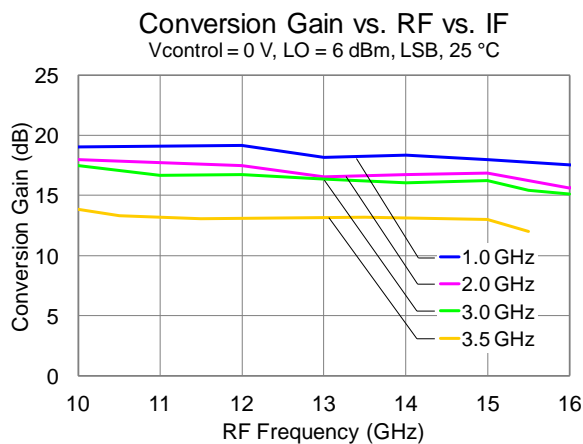
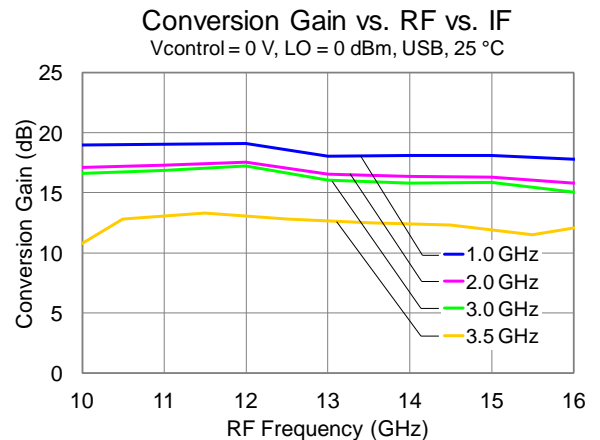
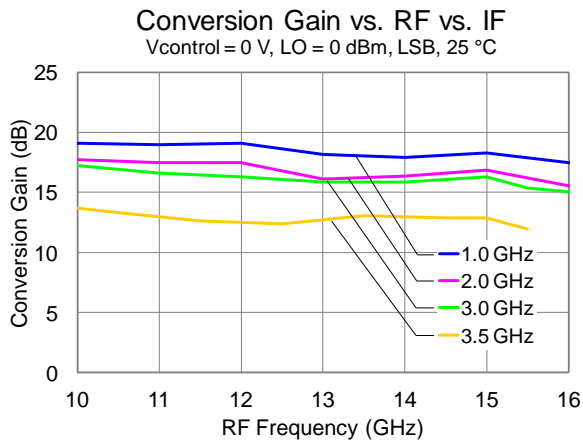

Performance Plots

IF Input Power = -10 dBm, VDLO = 5 V, IDLO = 60 mA, VDRF = 5 V, IDRf = 240 mA, VGX = -1.2 V, VREF = 2 V.
 Data taken with external IF hybrid and LO nulling applied.

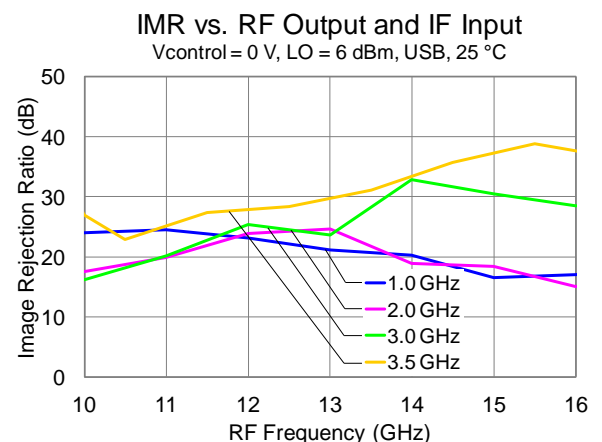
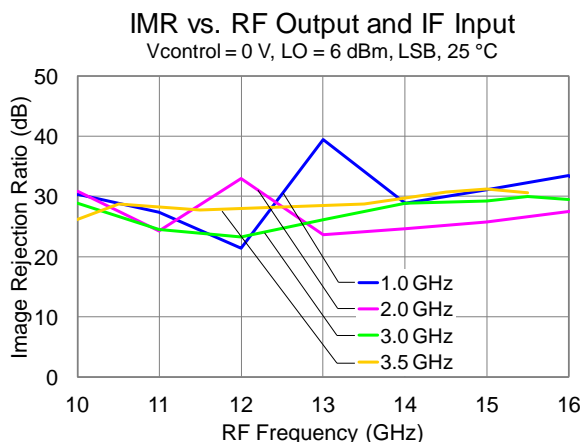
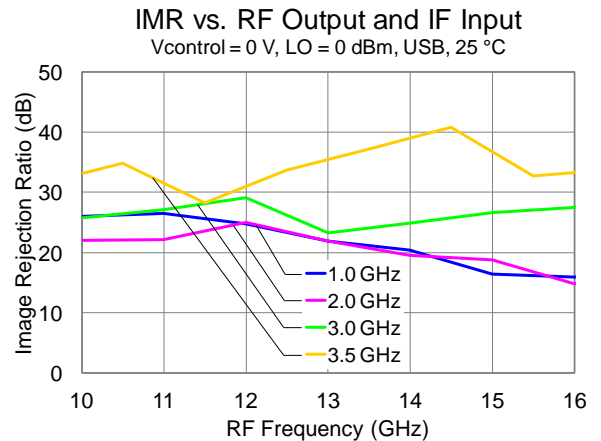
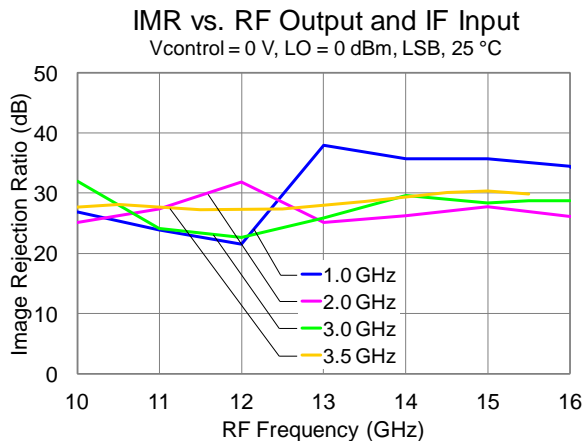
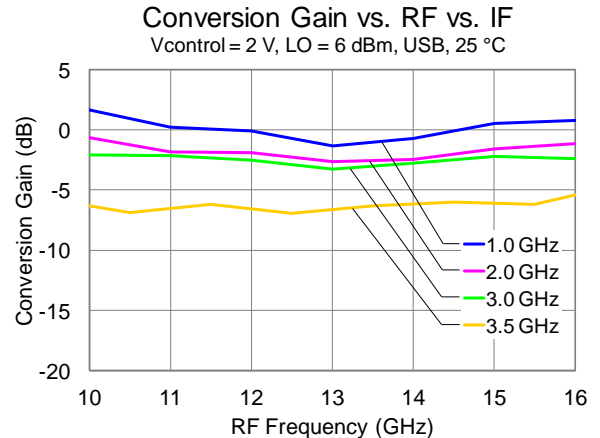
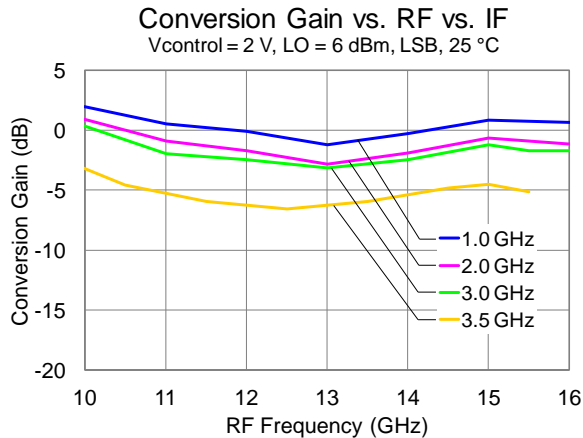

Performance Plots

IF Input Power = -10 dBm, VDLO = 5 V, IDLO = 60 mA, VDRF = 5 V, IDRF = 240 mA, VGX = -1.2 V, VREF = 2 V.
 Data taken with external IF hybrid and LO nulling applied.

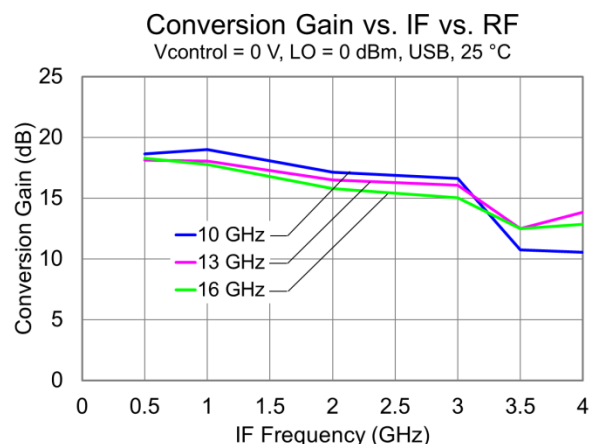
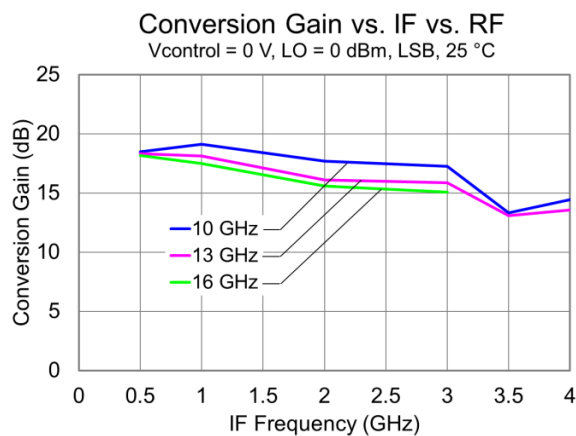
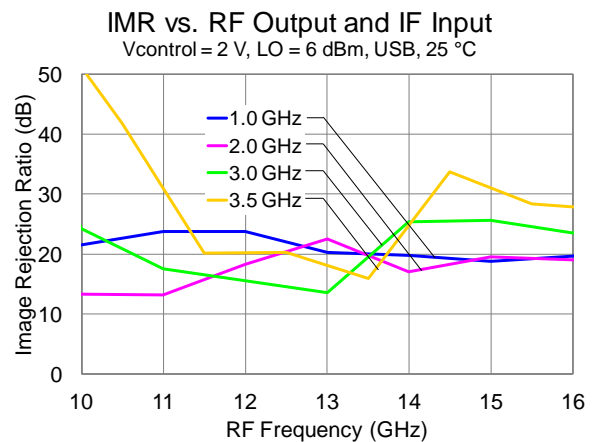
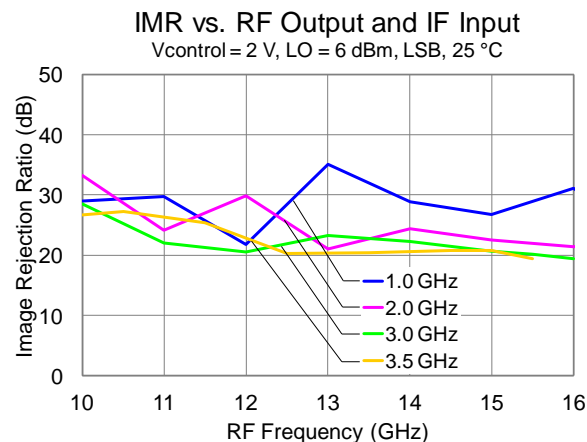
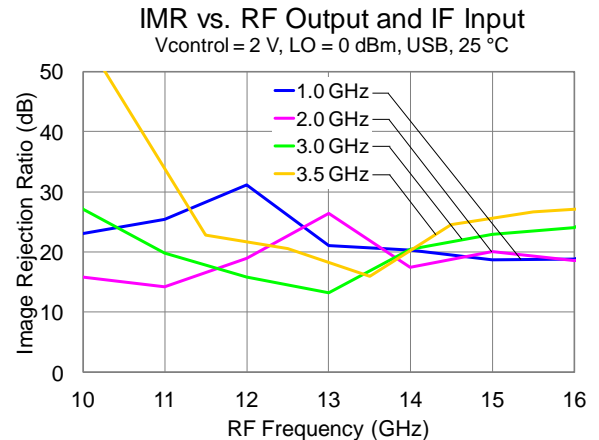
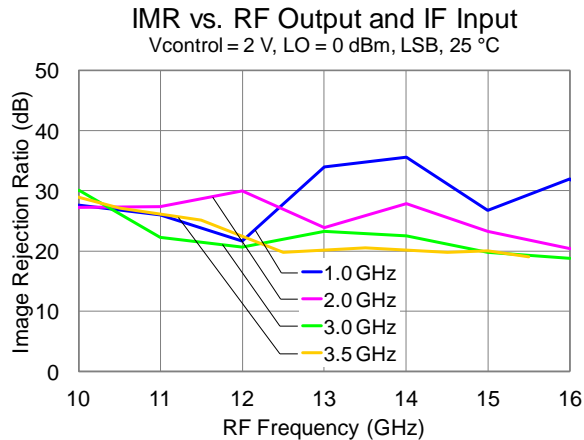

Performance Plots

IF Input Power = -10 dBm, VDLO = 5 V, IDLO = 60 mA, VDRF = 5 V, IDRF = 240 mA, VGX = -1.2 V, VREF = 2 V.
 Data taken with external IF hybrid and LO nulling applied.

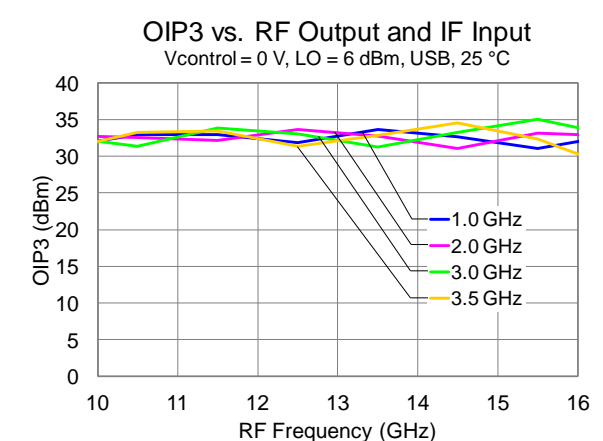
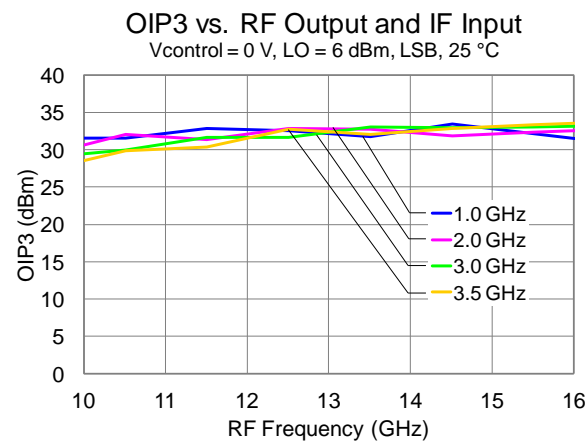
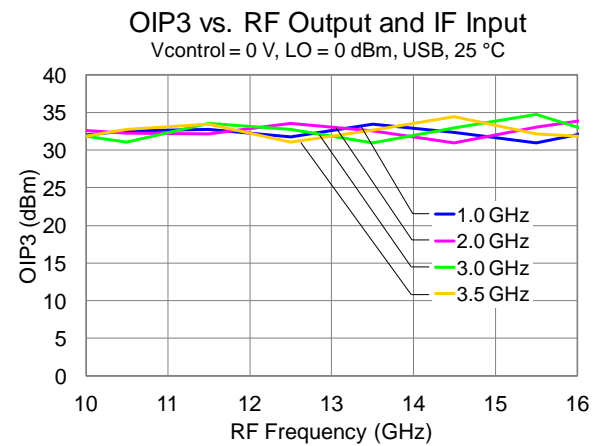
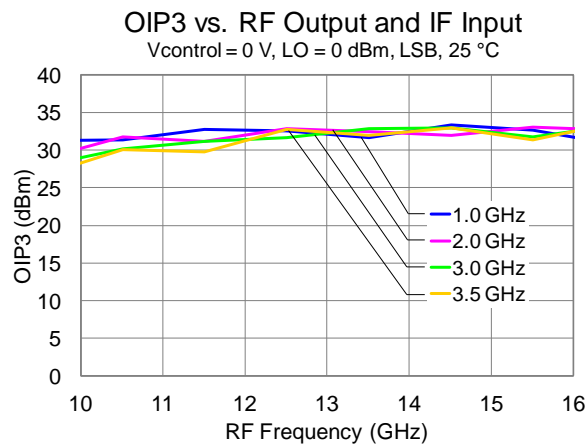
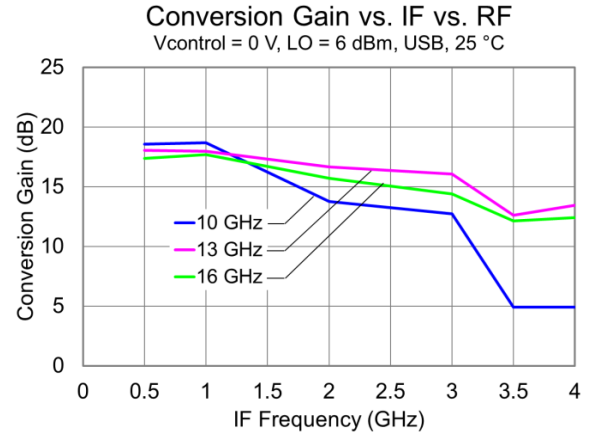
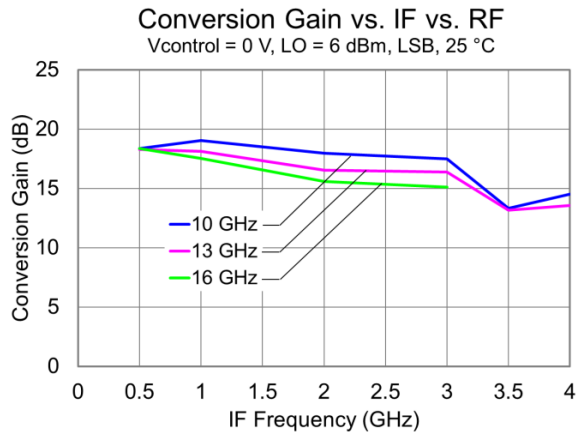

Performance Plots

IF Input Power = -10 dBm, VDLO = 5 V, IDLO = 60 mA, VDRF = 5 V, IDRF = 240 mA, VGX = -1.2 V, VREF = 2 V.
 Data taken with external IF hybrid and LO nulling applied.

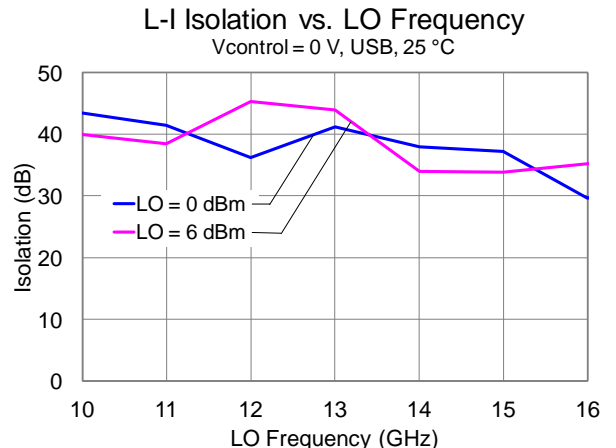
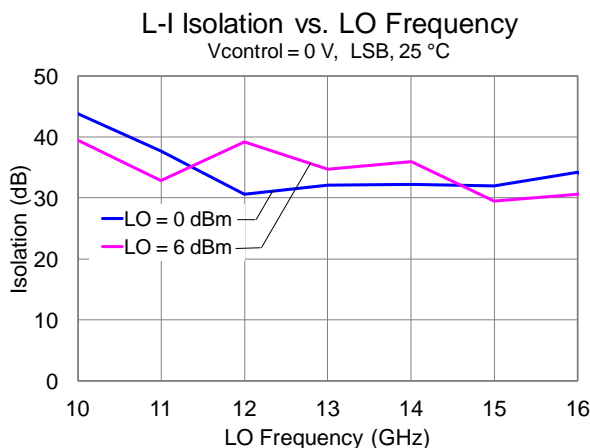
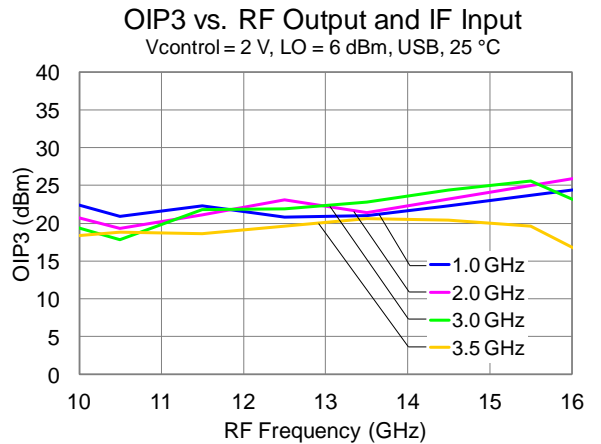
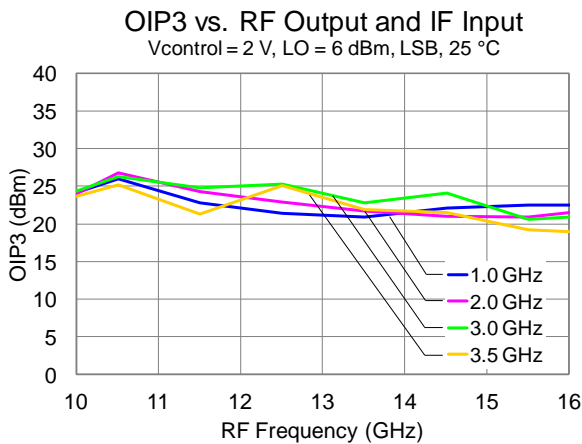
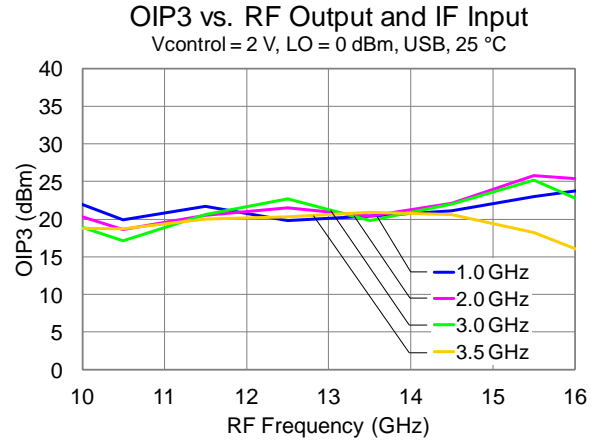
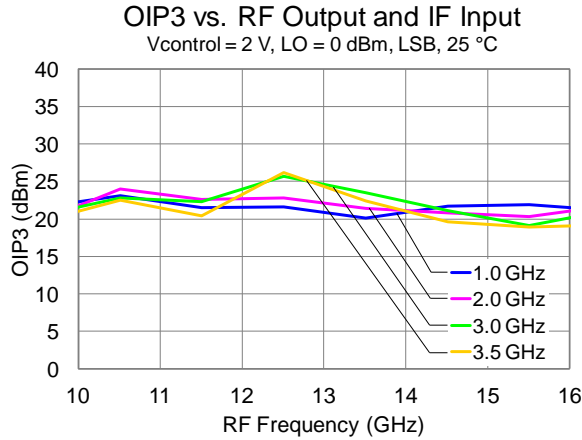

Performance Plots

IF Input Power = -10 dBm, VDLO = 5 V, IDLO = 60 mA, VDRF = 5 V, IDRf = 240 mA, VGX = -1.2 V, VREF = 2 V.
Data taken with external IF hybrid and LO nulling applied.

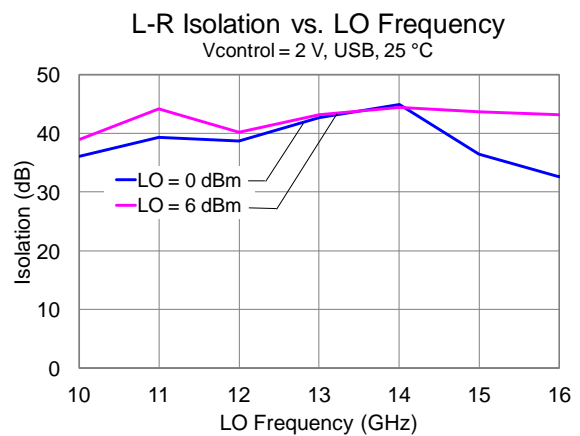
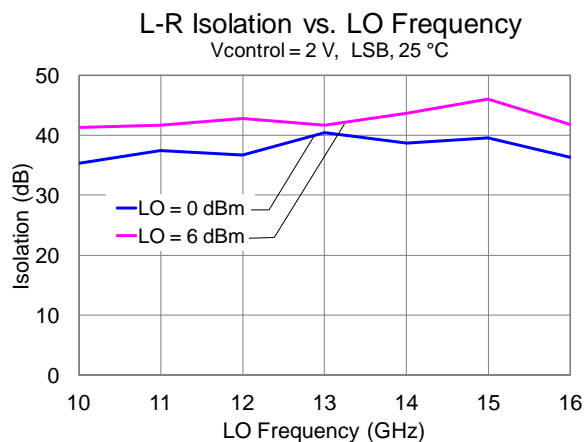
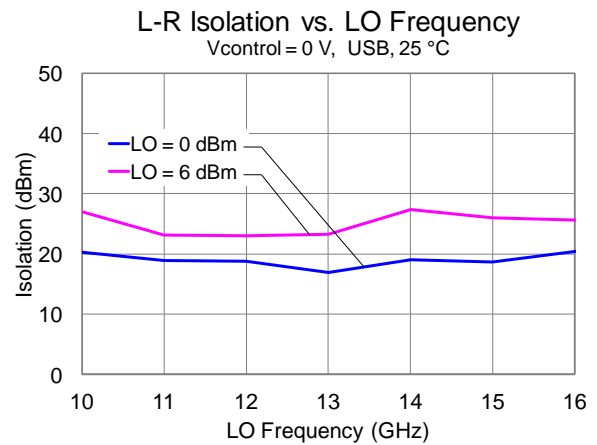
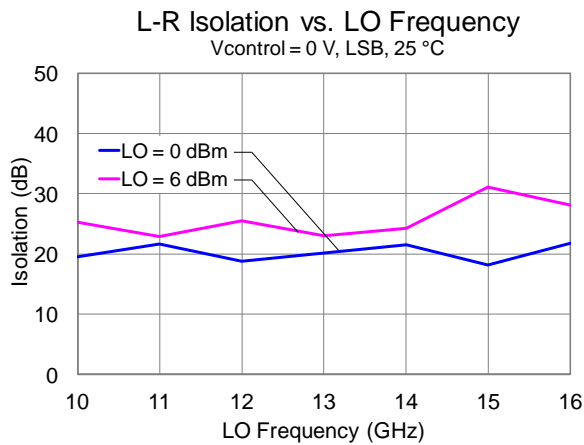
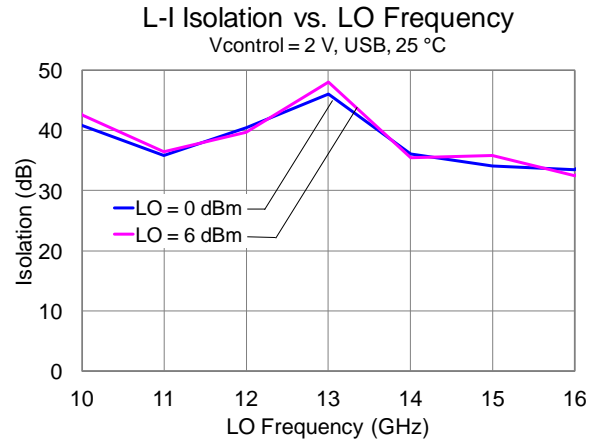
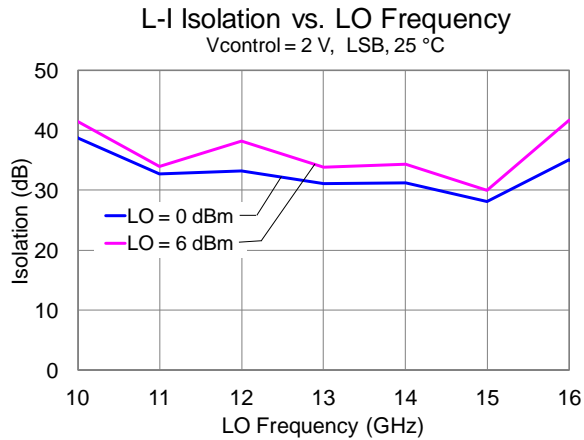

Performance Plots

IF Input Power = -10 dBm, VDLO = 5 V, IDLO = 60 mA, VDRF = 5 V, IDRF = 240 mA, VGX = -1.2 V, VREF = 2 V.
 Data taken with external IF hybrid and LO nulling applied.

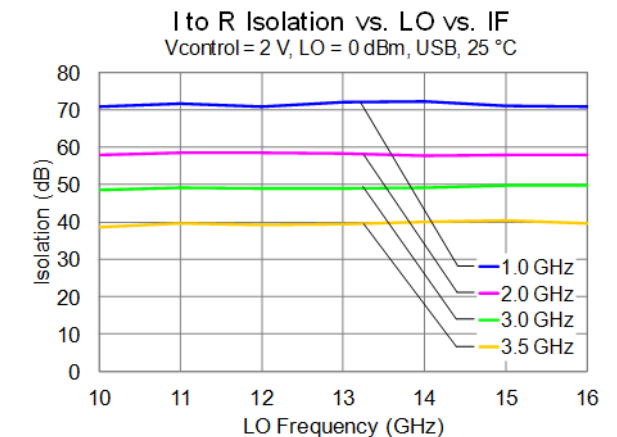
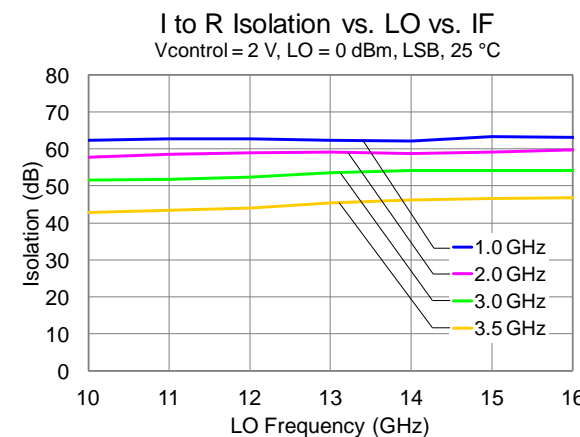
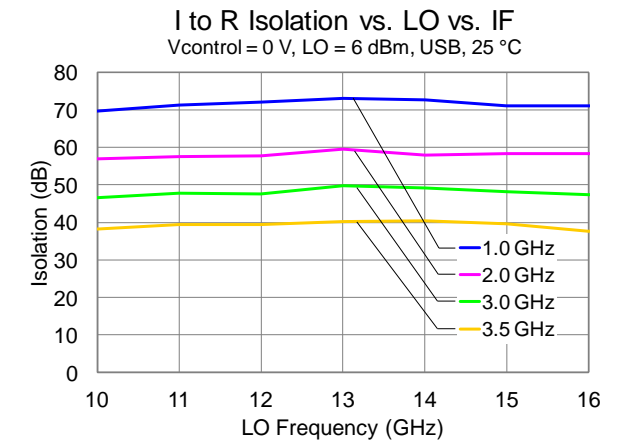
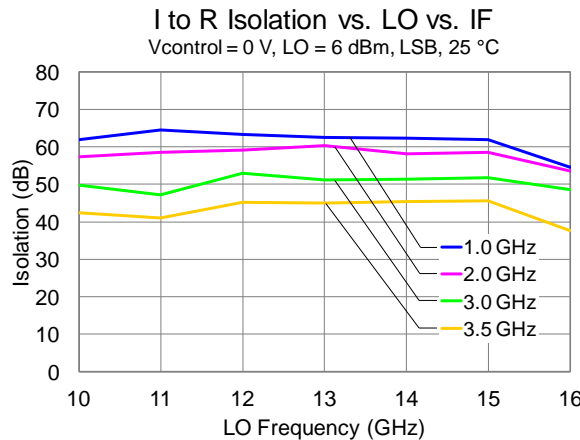
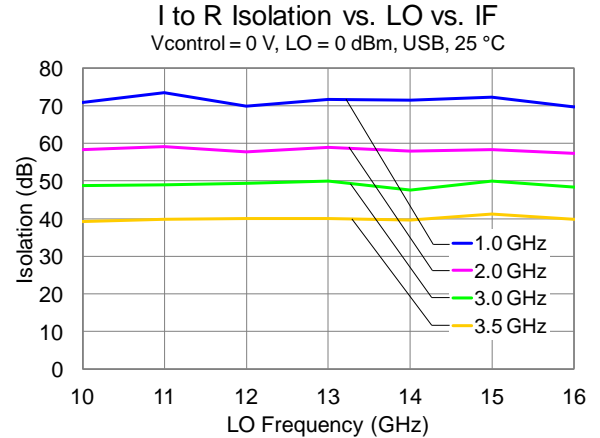
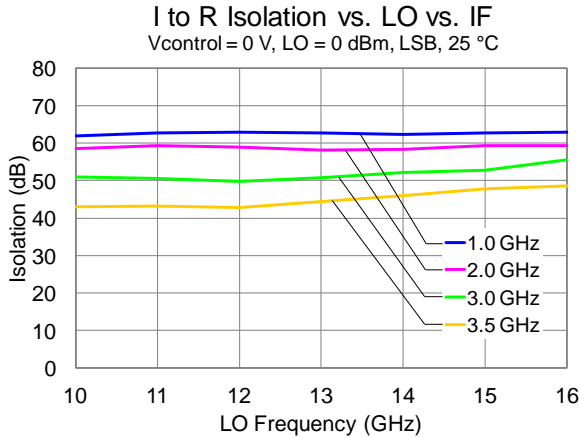

Performance Plots

IF Input Power = -10 dBm, VDLO = 5 V, IDLO = 60 mA, VDRF = 5 V, IDRF = 240 mA, VGX = -1.2 V, VREF = 2 V.
 Data taken with external IF hybrid and LO nulling applied.

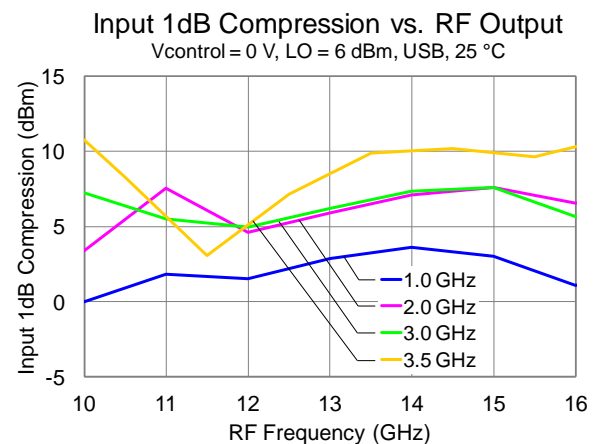
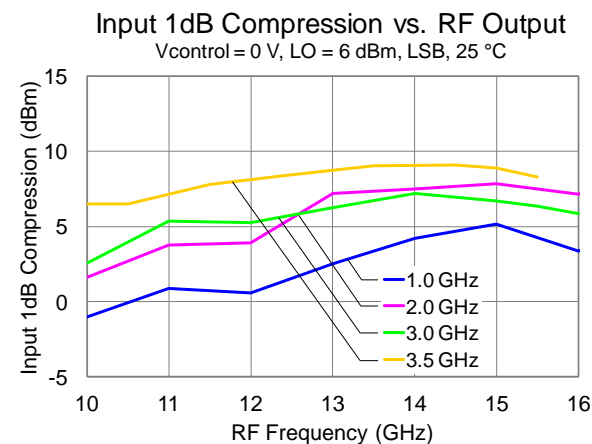
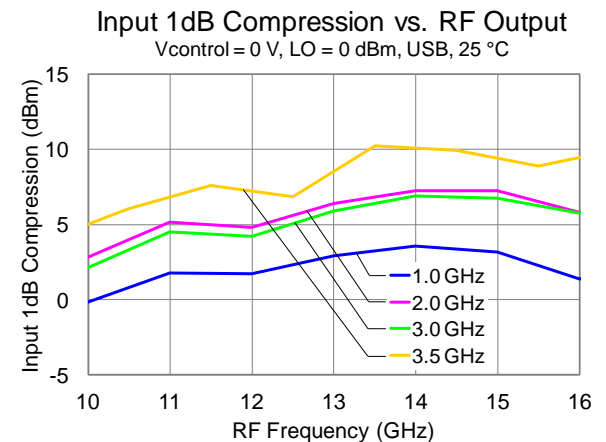
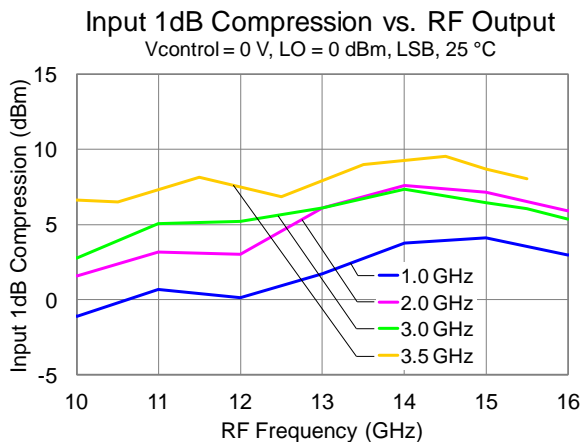
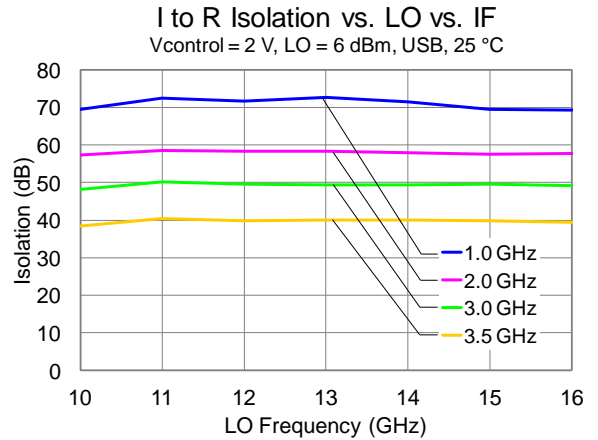
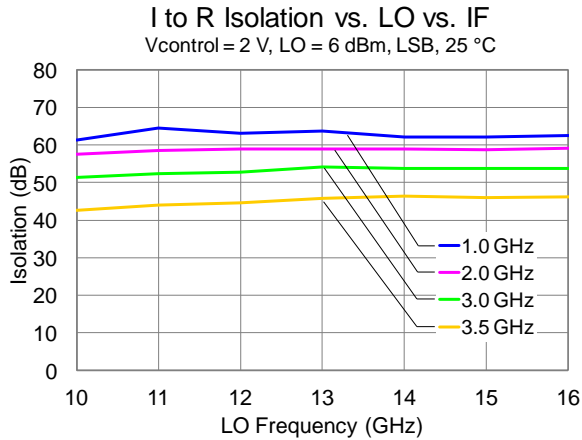

Performance Plots

IF Input Power = -10 dBm, VDLO = 5 V, IDLO = 60 mA, VDRF = 5 V, IDRF = 240 mA, VGX = -1.2 V, VREF = 2 V.
 Data taken with external IF hybrid and LO nulling applied.

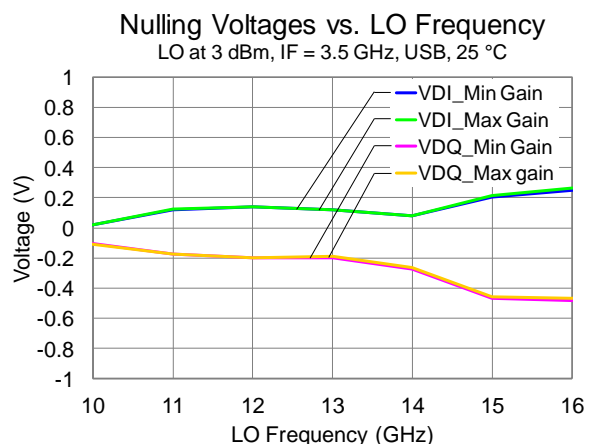
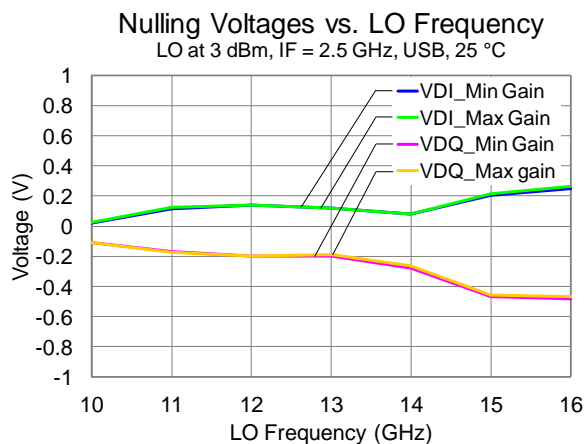
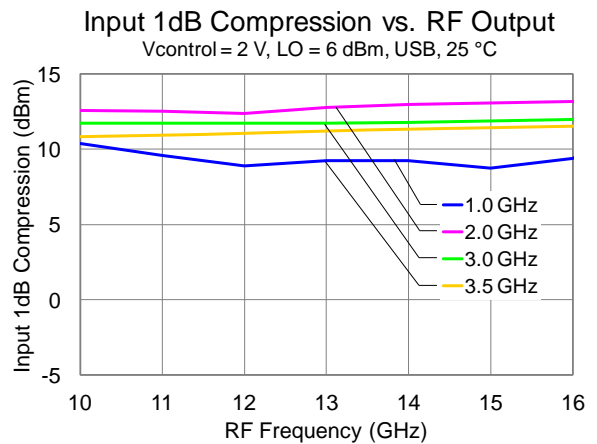
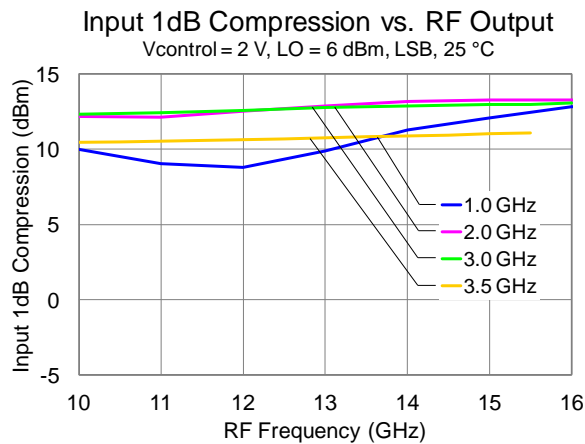
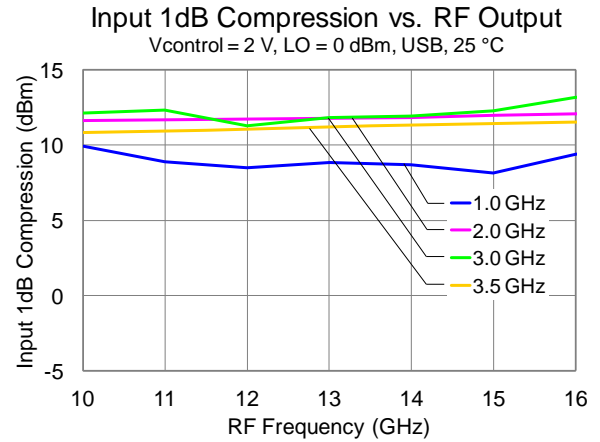
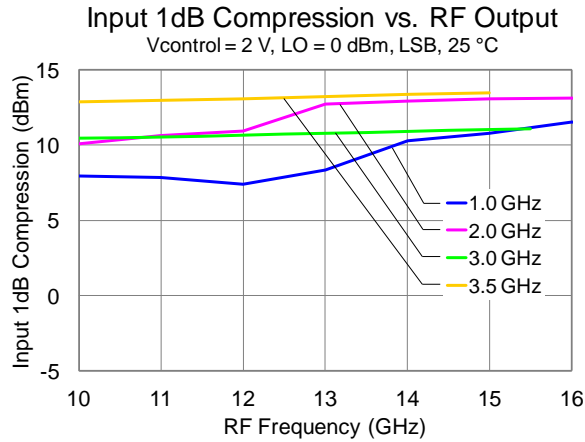

Performance Plots

IF Input Power = -10 dBm, VDLO = 5 V, IDLO = 60 mA, VDRF = 5 V, IDRF = 240 mA, VGX = -1.2 V, VREF = 2 V.
 Data taken with external IF hybrid and LO nulling applied.

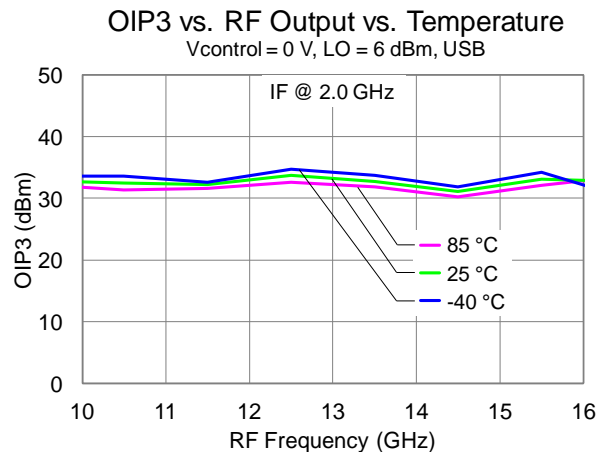
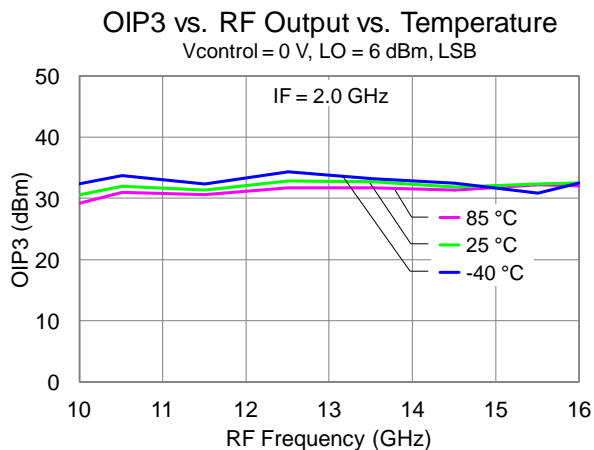
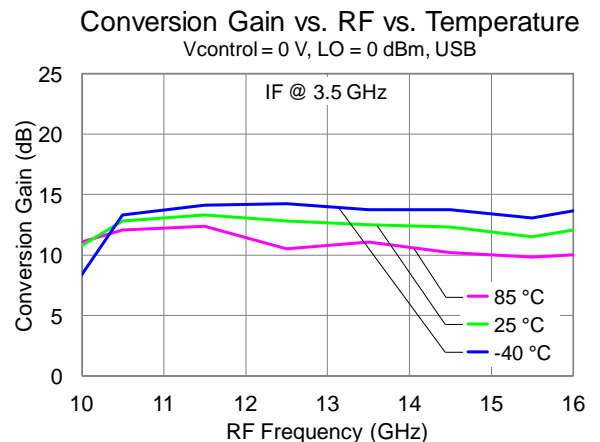
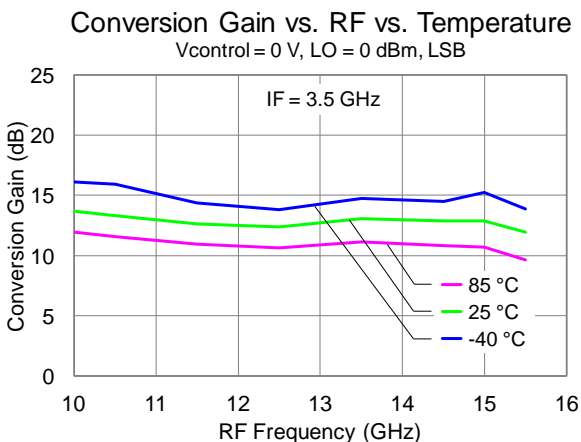
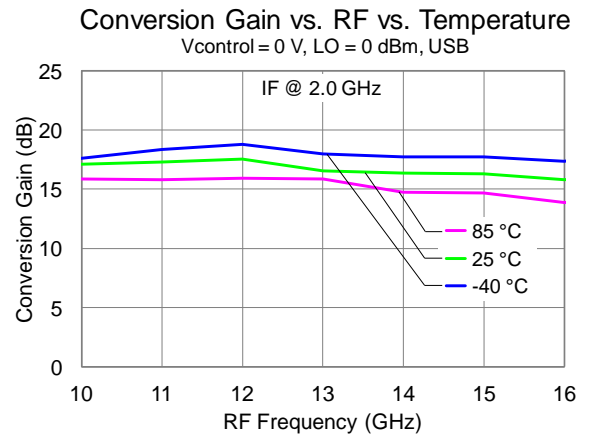
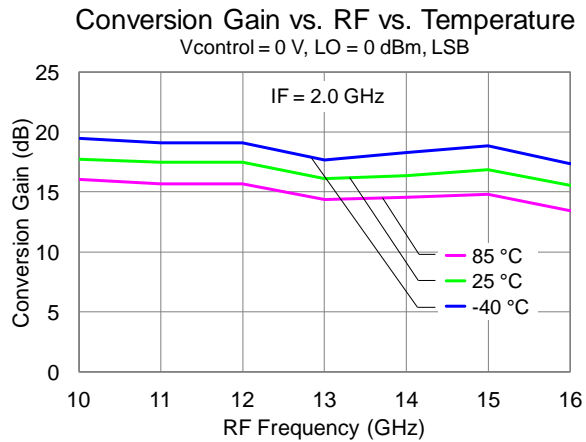

Performance Plots

IF Input Power = -10 dBm, VDLO = 5 V, IDLO = 60 mA, VDRF = 5 V, IDRF = 240 mA, VGX = -1.2 V, VREF = 2 V.
Data taken with external IF hybrid and LO nulling applied.

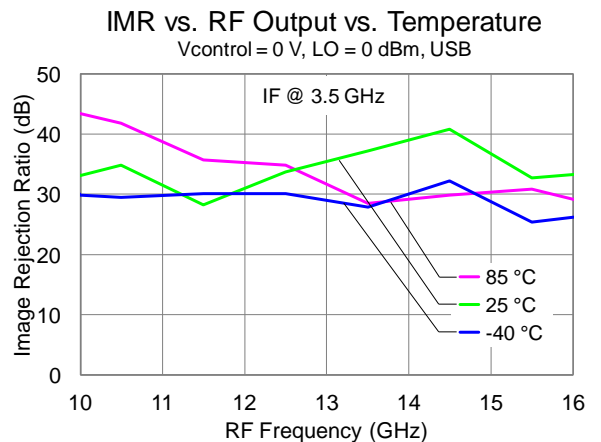
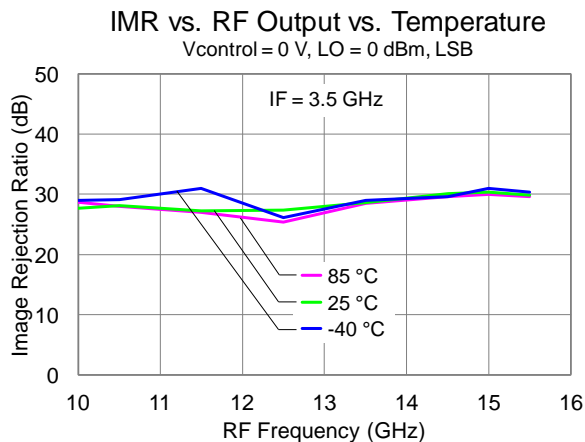
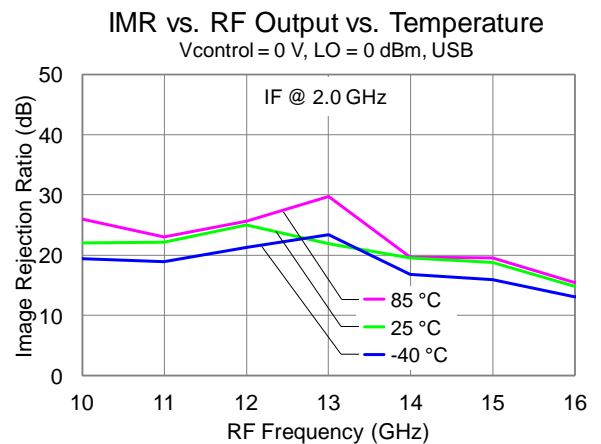
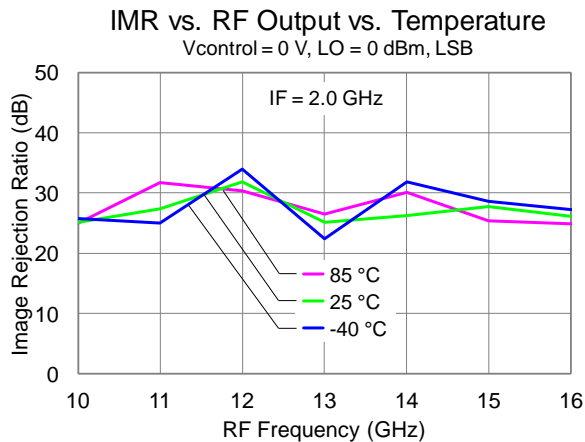
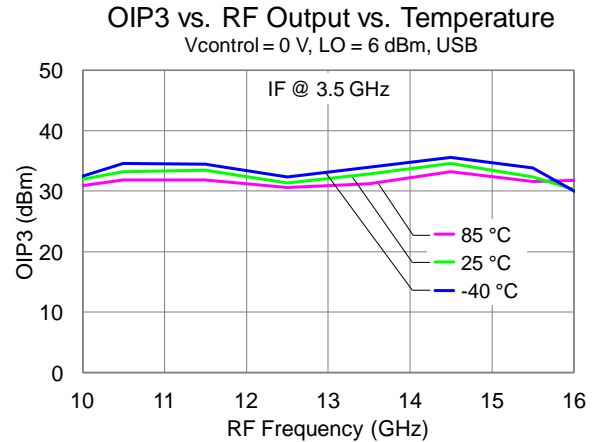
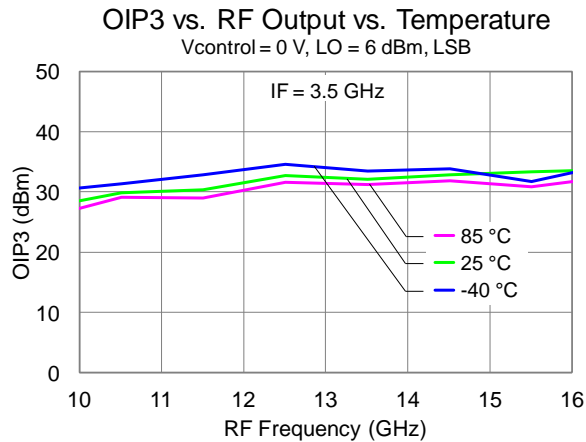

Mixing Products

IF Input Power = -10 dBm, VDLO = 5 V, IDLO = 60 mA, VDRF = 5 V, IDRf = 240 mA. VGX = -1.2 V, VREF = 2 V.
Data taken with external IF hybrid and LO nulling applied.

M x N Spurious Outputs for LSB

LO = 0 – 6 dBm, 25 °C; All values are in dBc.

For LSB IF = 2.0 GHz: LO = 12.0 GHz to 18.0 GHz; IF = 3.5 GHz: LO = 13.5 GHz to 19.0 GHz.

Spurious Suppression (dBc) for IF = 2.0 GHz				
RF/LO	0	1	2	3
-3	---	70	79	76
-2	---	44	40	75
-1	---	0	38	69
0	---	24	30	38
1	61	24	69	68
2	62	44	79	75
3	72	78	78	76

Spurious Suppression (dBc) for IF = 3.5 GHz				
RF/LO	0	1	2	3
-3	---	84	75	73
-2	---	50	45	71
-1	---	0	59	63
0	---	21	28	34
1	51	27	64	69
2	49	64	74	74
3	85	77	70	---

M x N Spurious Outputs for USB

LO = 0 – 6 dBm, 25 °C; All values are in dBc.

For USB IF = 2.0 GHz: LO = 8.0 GHz to 14.0 GHz; IF = 3.5 GHz: LO = 6.5 GHz to 12.5 GHz.

Spurious Suppression (dBc) for IF = 2.0 GHz				
RF/LO	0	1	2	3
-3	---	70	46	44
-2	---	46	29	54
-1	---	17	20	15
0	---	23	-17	25
1	56	0	8	26
2	28	33	32	62
3	48	43	66	71

Spurious Suppression (dBc) for IF = 3.5 GHz				
RF/LO	0	1	2	3
-3	---	62	66	49
-2	---	70	33	41
-1	---	23	8	14
0	---	19	-29	-17
1	23	0	4	11
2	27	30	38	41
3	56	58	64	72

Pin Configuration and Description

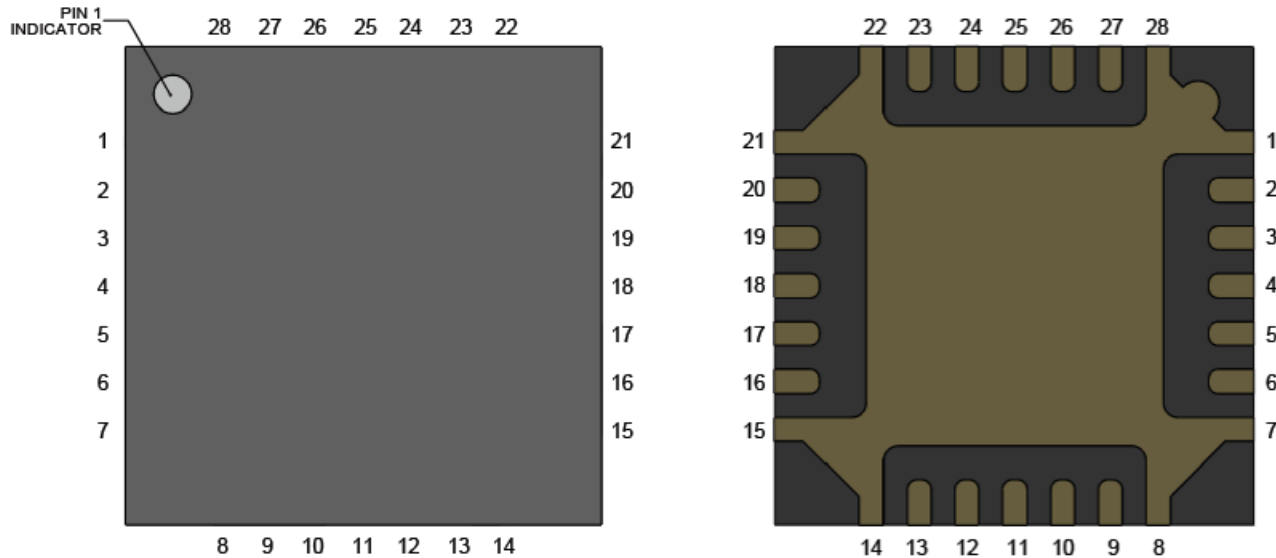

Pin No.	Label	Description
1, 7, 8, 9, 13, 14, 15, 16, 21, 22, 26, 28	GND	Internal Grounding; must be grounded on PCB.
2	RF OUT	RF Output matched to 50 ohms, AC Coupled.
3, 11, 18, 19, 20	NC	No internal connection; must be grounded on PCB.
4	VCTRL	Control Voltage. Bias network is required; see Application Circuit on page 17 as an example.
5	VREF	Reference Voltage. Bias network is required; see Application Circuit on page 17 as an example.
6	VGRF	RF Gate Voltage. Bias network is required; see Application Circuit on page 17 as an example.
10	IF1	IF Input matched to 50 ohms, DC coupled.
12	IF2	IF Input matched to 50 ohms, DC coupled.
17	LO IN	LO Input, matched to 50 ohms, AC coupled.
23	VGLO	LO Gate Voltage. Bias network is required; see Application Circuit on page 17 as an example.
24	VDLO	LO Drain Voltage. Bias network is required; see Application Circuit on page 17 as an example.
25	VGX	Mixer Voltage. Bias network is required; see Application Circuit on page 17 as an example.
27	VDRF	RF Drain Voltage. Bias network is required; see Application Circuit on page 17 as an example.
29	GND	Backside Paddle. Multiple vias should be employed to minimize inductance and thermal resistance; see Mounting Configuration on page 20 for suggested footprint.

Applications Circuit

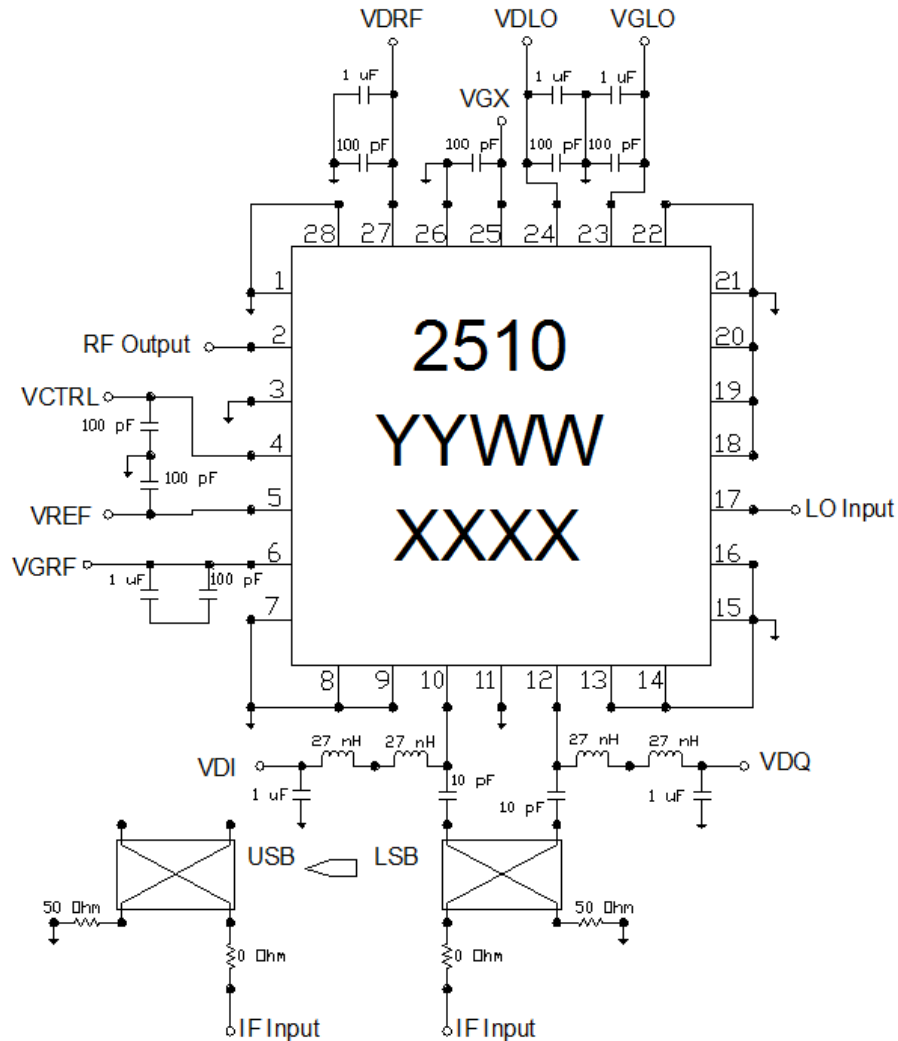

Bias-up Procedure

Set VGX = -1.2 V, Set VREF = 2.0 V, Set VCTRL = 0 V
Set VGLO = -1.5 V, Set VDLO = 5.0 V

Set VGX, VREF, VCTRL, VGLO, VGRF, VDI, VDQ
current limits to 10 mA

Set IDLO limit to 100 mA, Set IDRF limit to 350 mA

Increase VGLO to get IDLO = 60 mA

Set VGRF = -1.5 V, Set VDRF = 5.0 V

Increase VGRF to get IDRF = 240 mA

Set VDI, VDQ to 0V; or no connection

Apply LO and RF signals

Bias-down Procedure

Turn off RF and LO signals

Reduced VDLO = 0 V

Reduce VDRF = 0 V

Set VDI = 0 V, if used for LO nulling

Set VDQ = 0 V, if used for LO nulling

Reduced VGLO = 0V, VGRF = 0 V, VREF = 0 V

Reduce VCTRL = 0 V

Reduced VGX = 0 V

Evaluation Board (EVB) Assembly Layout

Board material is RO4003 0.008" thickness with ½ oz copper cladding.

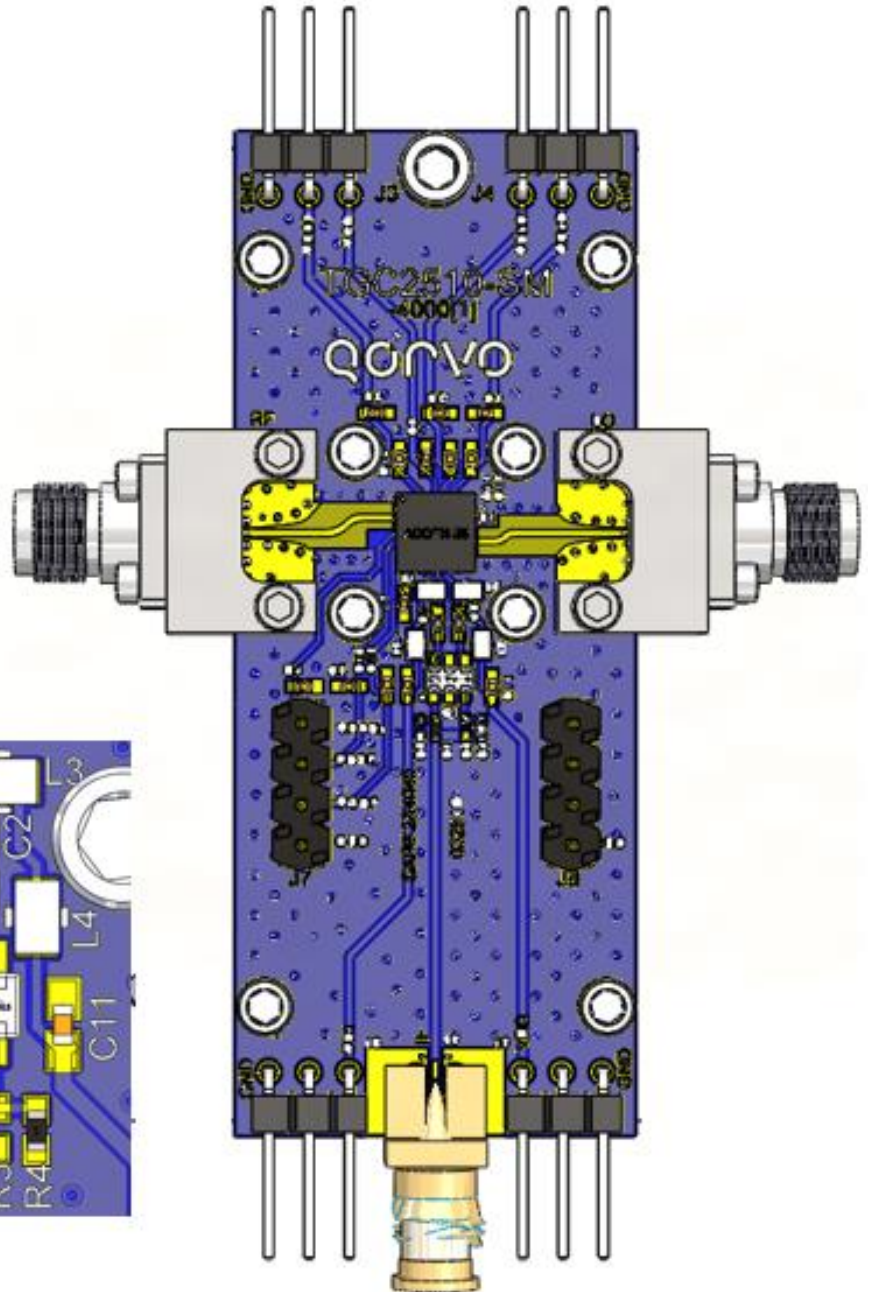
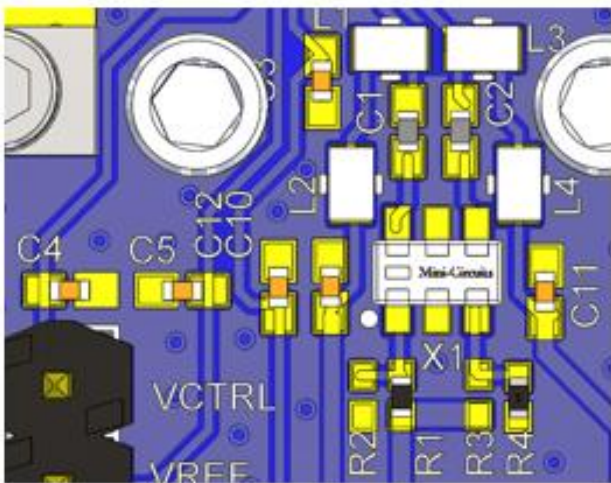
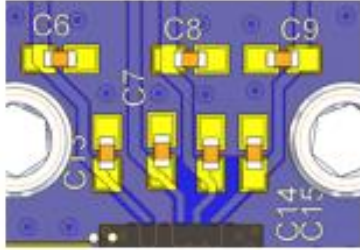

Application Circuit Component

Bill of Material

Ref Des	Value	Description	Manufacturer	Part Number
C1 – C2	10 pF	Cap, 0402, 50V, 5%, NPO	various	
C3 - C5, C7, C13 - C15	100 pF	Cap, 0402, 50V, 5%, NPO	various	
C10 – C12, C6, C8, C9	1 μ F	Cap, 0805, 25V, 5%, X5R	various	
L1 – L4	27 nH	Ind, 0201, 100 mA, 5%, SMD	various	
Q1		Ku-Band Up-Converter	QORVO	TGC2510-SM

LSB Configuration

Ref Des	Value	Description	Manufacturer	Part Number
X1		IF Quad Coupler, 1.35 to 2.45 GHz	Mini-Circuits	QCN-25+
X1		IF Quad Coupler, 2.5 to 4.0 GHz	Mini-Circuits	QCN-45+
R1	0 Ω	Res, 0402, 0.01W, SMD	various	
R4	50 Ω	Res, 0402, 0.05W, 0.1%, SMD	various	
R2, R3		DNP		

USB Configuration

Ref Des	Value	Description	Manufacturer	Part Number
X1		IF Quad Coupler, 1.35 to 2.45 GHz	Mini-Circuits	QCN-25+
X1		IF Quad Coupler, 2.5 to 4.0 GHz	Mini-Circuits	QCN-45+
R3	0 Ω	Res, 0402, 0.01W, SMD	various	
R2	50 Ω	Res, 0402, 0.05W, 0.1%, SMD	various	
R1, R4		DNP		

Note: Due to bandwidth limitations of IF quad coupler, two versions of coupler were used on EVBs, users need to choose low or high band of IF to be used, in addition to LSB and USB selection. Refer to ordering information section for details.

Package Marking and Dimensions

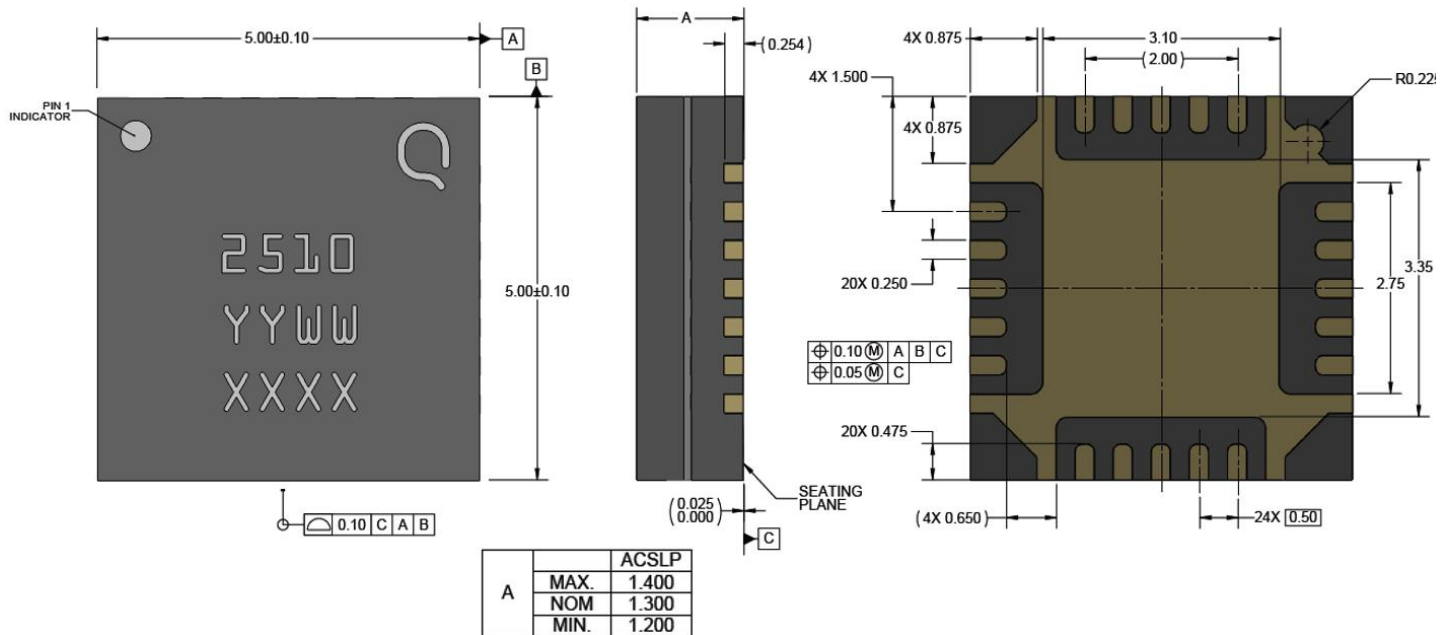

The TGC2510-SM will be marked with the "2510" designator. The "YY" represents the last two digits of the year the part was manufactured, the "WW" is the work week, and the "XXXX" is batch ID.

This package is lead-free/RoHS-compliant with a copper alloy base (CDA194), and the plating material on the leads is NiPdAu. It is compatible with a lead-free (maximum 260 °C reflow temperature) soldering process.

PCB Mounting Pattern

Notes:

1. The pad pattern shown has been developed and tested for optimized assembly at TriQuint Semiconductor. The PCB land pattern has been developed to accommodate lead and package tolerances. Since surface mount processes vary from company to company, careful process development is recommended.
2. Ground / thermal vias are critical for the proper performance of this device. Vias should use a .35mm diameter drill and have a final plated thru diameter of .25 mm.

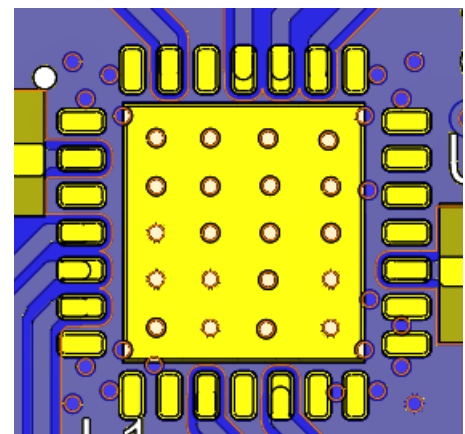

Tape and Reel Information

Standard T/R size = 500 pieces on a 7" reel.

Material		Cavity (mm)				Distance Between Centerline (mm)		Carrier Tape (mm)	Cover Carrier (mm)
Vendor	Vendor P/N	Length (A0)	Width (B0)	Depth (K0)	Pitch (P1)	Length direction (P2)	Width Direction (F)	Width (W)	Width (W)
Tek-Pak	QFN0500X0 500F-L500	5.3	5.3	1.65	8.0	2.00	5.50	12.0	9.20

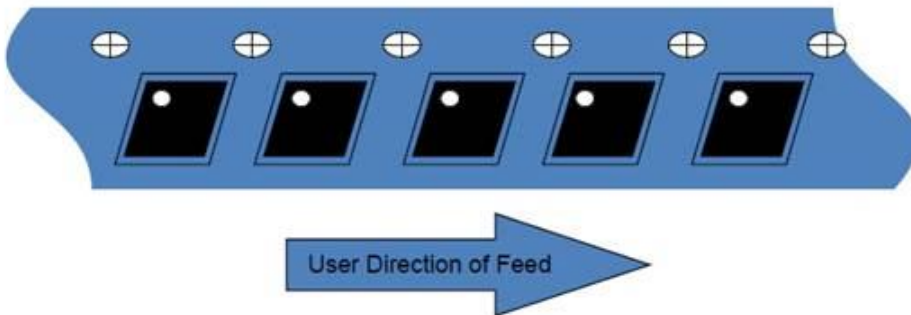
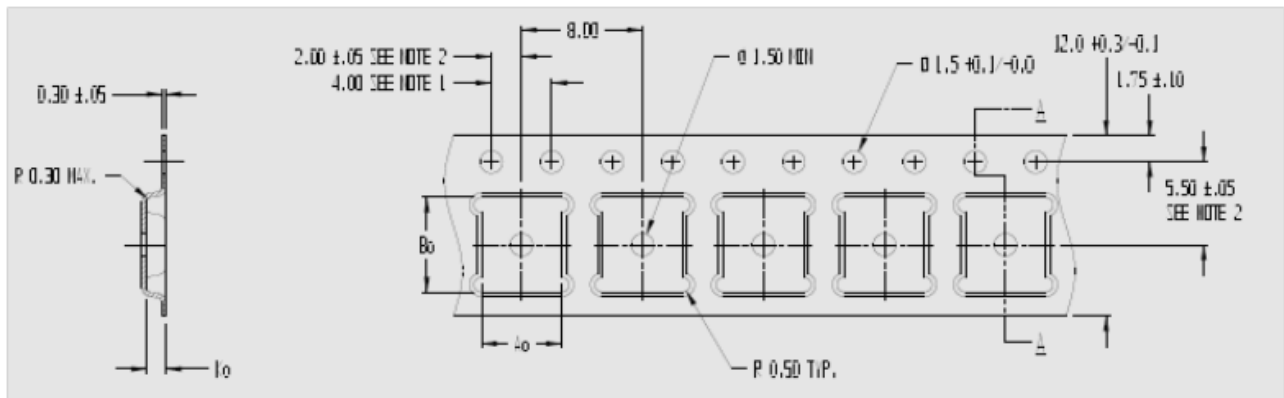

Assembly Notes

Compatible with lead-free soldering processes with 260°C peak reflow temperature.

This package is air-cavity and non-hermetic, and therefore cannot be subjected to aqueous washing. The use of no-clean solder to avoid washing after soldering is highly recommended.

Contact plating: Ni-Pd-Au.

Solder rework not recommended.

Recommended Soldering Temperature Profile

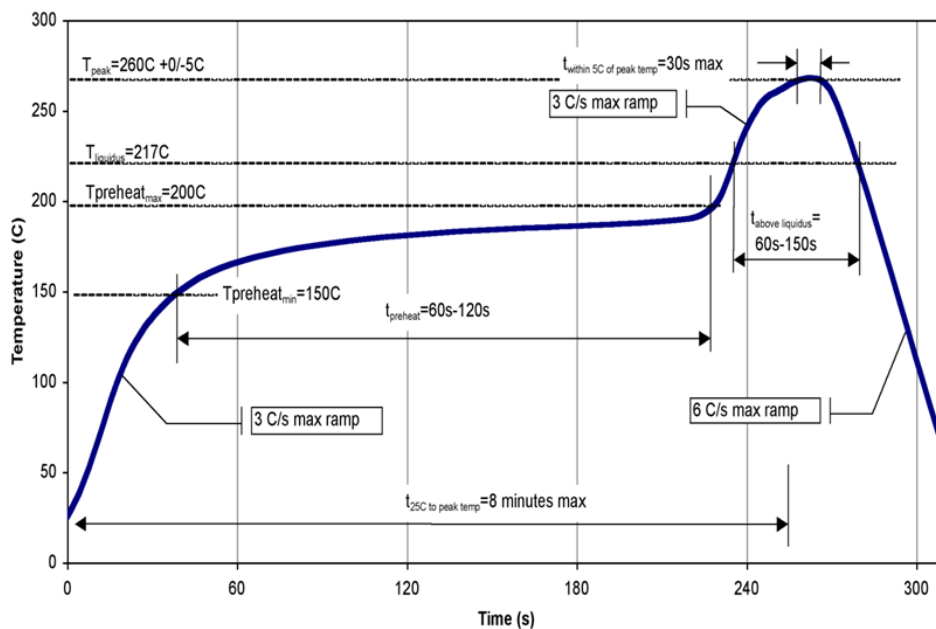

Handling Precautions

Parameter	Rating	Standard
ESD – Human Body Model (HBM)	Class 0	ESDA / JEDEC JS-001-2012
MSL – Moisture Sensitivity Level	Level 1	IPC/JEDEC J-STD-020



Caution!
ESD-Sensitive Device

RoHS Compliance

This product is compliant with the 2011/65/EU RoHS directive (Restrictions on the Use of Certain Hazardous Substances Electrical and Electronic Equipment), as amended by Directive 2015/863/EU. This product also has the following attributes

- Lead Free
- Halogen Free (Chlorine, Bromine)
- Antimony Free
- TBBP-A (C₁₅H₁₂Br₄O₂) Free
- PFOS Free
- SVHC Free

Contact Information

For the latest specifications, additional product information, worldwide sales and distribution locations:

Tel: 1-844-890-8163

Web: www.qorvo.com

Email: customer.support@qorvo.com

Important Notice

The information contained herein is believed to be reliable; however, Qorvo makes no warranties regarding the information contained herein and assumes no responsibility or liability whatsoever for the use of the information contained herein. The information contained herein is subject to change without notice. Customers should obtain and verify the latest relevant information before placing orders for Qorvo products. The information contained herein or any use of such information do not grant, explicitly or implicitly, to any party any patent rights, licenses, or any other intellectual property rights, whether with regard to such information itself or anything described by such information. **THIS INFORMATION DOES NOT CONSTITUTE A WARRANTY WITH RESPECT TO THE PRODUCTS DESCRIBED HEREIN, AND QORVO HEREBY DISCLAIMS ALL WARRANTIES WITH RESPECT TO SUCH PRODUCTS WHETHER EXPRESS OR IMPLIED BY LAW, COURSE OF DEALING, COURSE OF PERFORMANCE, USAGE OF TRADE OR OTHERWISE, INCLUDING THE IMPLIED WARRANTIES OF MERCHANTABILITY AND FITNESS FOR A PARTICULAR PURPOSE.**

Without limiting the generality of the foregoing, Qorvo products are not warranted or authorized for use as critical component in medical, life-saving, or life-sustaining applications, or other applications where a failure would reasonably be expected cause severe personal injury or death.

Copyright 2020 © Qorvo, Inc. | Qorvo is a registered trademark of Qorvo, Inc.

X-ON Electronics

Largest Supplier of Electrical and Electronic Components

Click to view similar products for [Up-Down Converters](#) category:

Click to view products by [Qorvo](#) manufacturer:

Other Similar products are found below :

[HMC7586-SX](#) [HMC7587](#) [HMC8119-SX](#) [HMC7587-SX](#) [HMC6147ALC5ATR](#) [MDS-158-PIN](#) [HMC7912LP5ETR](#) [HMC377QS16GETR](#)
[MY87C](#) [CSM2-10](#) [CHR3762-QDG](#) [AD6620ASZ-REEL](#) [ADF5904ACPZ](#) [ADF5904WCCPZ](#) [AD6623ASZ](#) [AD6633BBCZ](#) [AD6634BBCZ](#)
[AD9957BSVZ](#) [AD9957BSVZ-REEL](#) [ADMV1009AEZ](#) [ADMV1010AEZ](#) [ADMV1011AEZ](#) [ADMV1012AEZ](#) [ADRF6658BCPZ](#)
[HMC1065LP4E](#) [HMC951ALP4E](#) [HMC571](#) [HMC6146BLC5A](#) [HMC6146BLC5ATR](#) [HMC572LC5](#) [HMC925LC5](#) [HMC6787ALC5A](#)
[HMC6787ALC5ATR](#) [HMC682LP6CE](#) [HMC571LC5TR](#) [HMC7911LP5E](#) [HMC7912LP5E](#) [HMC908ALC5](#) [HMC951BLP4ETR](#)
[HMC967LP4E](#) [HMC977LP4E](#) [AD6634BBC](#) [HMC6505ALC5](#) [MAUC-011003-TR0500](#) [MAX9996ETP+T](#) [MAX19996AETP+](#)
[MAX19996ETP+](#) [MAX2039ETP+](#) [MAX2410EEI+](#) [MAX2411AEEI+](#)