

Product Overview

The Qorvo TGF2929-FL is a 107 W (P_{3dB}) discrete GaN on SiC HEMT which operates from DC to 3.5 GHz. The device features advanced field plate techniques to optimize power and efficiency at high drain bias operating conditions. This optimization can potentially lower system costs in terms of fewer amplifier line-ups and lower thermal management costs.

Lead-free and ROHS compliant.

Evaluation boards are available upon request.



Functional Block Diagram

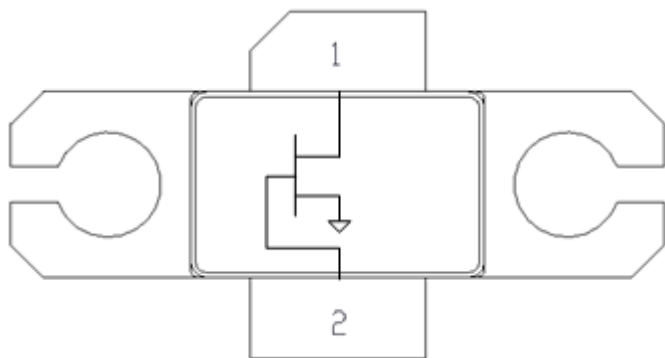

Key Features

- Frequency: DC to 3.5 GHz
 - Output Power (P_{3dB})¹: 107 W
 - Linear Gain¹: 17 dB
 - Typical DEff_{3dB}¹: 60.8%
 - Operating Voltage: 28 V
 - Low thermal resistance package
 - Pulse capable
- Note 1: @ 3.5 GHz

Applications

- Military radar
- Civilian radar
- Professional and military radio communications
- Test instrumentation
- Wideband or narrowband amplifiers
- Jammers

Part No.	Description
TGF2929-FL	DC–3.5 GHz RF Power Transistor
TGF2929-FLEVB01	3.1 – 3.5 GHz Evaluation Board



TGF2929-FL

100W, 28V, DC–3.5 GHz, GaN RF Power Transistor

Absolute Maximum Ratings¹

Parameter	Rating	Units
Breakdown Voltage, BV_{DG}	+145	V
Gate Voltage Range, V_G	-7 to +2	V
Drain Current	12	A
Gate Current Range, I_G	See page 4.	mA
Power Dissipation, 20% DC 500 μ S PW, P_{DISS} , $T = 85^\circ\text{C}$	144	W
RF Input Power, CW, $T = 25^\circ\text{C}$	+39.8	dBm
Mounting Temperature (30 Seconds)	320	$^\circ\text{C}$
Storage Temperature	-65 to +150	$^\circ\text{C}$

Notes:

1. Operation of this device outside the parameter ranges given above may cause permanent damage.

Recommended Operating Conditions¹

Parameter	Min	Typ	Max	Units
Operating Temp. Range	-40	+25	+85	$^\circ\text{C}$
Drain Voltage Range, V_D	+12	+28	+50	V
Drain Bias Current, I_{DQ}	-	260	-	mA
Peak Drain Current, I_D^3	-	7.2	-	A
Gate Voltage, V_G^4	-	-2.7	-	V
Power Dissipation, CW (P_D) ²	-	-	82	W
Power Dissipation, Pulsed (P_D) ^{2, 3}	-	-	140	W

Notes:

1. Electrical performance is measured under conditions noted in the electrical specifications table. Specifications are not guaranteed over all recommended operating conditions.
2. Package base at 85°C
3. Pulse Width = 100 μ S, Duty Cycle = 20%
4. To be adjusted to desired I_{DQ}

Pulsed Characterization – Load-Pull Performance – Power Tuned¹

Parameters	Typical Values				Unit
	1.0	2.0	3.0	3.5	
Frequency, F	1.0	2.0	3.0	3.5	GHz
Linear Gain, G_{LIN}	21.2	16.7	15.6	15.8	dB
Output Power at 3dB compression point, P_{3dB}	100	132	120	107	W
Drain Efficiency at 3dB compression point, $DEff_{3dB}$	61.0	60.4	57.6	54.4	%
Gain at 3dB compression point	18.2	13.7	12.6	12.8	dB

Notes:

1. Test conditions unless otherwise noted: $V_D = +28\text{ V}$, $I_{DQ} = 260\text{ mA}$, $Temp = +25^\circ\text{C}$

Pulsed Characterization – Load-Pull Performance – Efficiency Tuned¹

Parameters	Typical Values				Unit
	1.0	2.0	3.0	3.5	
Frequency, F	1.0	2.0	3.0	3.5	GHz
Linear Gain, G_{LIN}	22.3	17.2	16.9	17.0	dB
Output Power at 3dB compression point, P_{3dB}	47.8	50.1	49.8	48.9	W
Drain Efficiency at 3dB compression point, $DEff_{3dB}$	76.6	66.9	68.3	60.8	%
Gain at 3dB compression point, G_{3dB}	19.3	14.2	13.9	14.0	dB

Notes:

1. Test conditions unless otherwise noted: $V_D = +28\text{ V}$, $I_{DQ} = 260\text{ mA}$, $Temp = +25^\circ\text{C}$



RF Characterization – 3.1 – 3.5 GHz EVB Performance At 3.3 GHz¹

Parameter	Min	Typ	Max	Units
Linear Gain, G_{LIN}	–	15.0	–	dB
Output Power at 3dB compression point, P_{3dB}	–	106	–	W
Power-Added Efficiency at 3dB compression point, PAE_{3dB}	–	51.3	–	%
Gain at 3dB compression point, G_{3dB}	–	12.0	–	dB

Notes:

1. $V_D = +28\text{ V}$, $I_{DQ} = 260\text{ mA}$, Temp = +25 °C, 100 μS , 20%

RF Characterization – Mismatch Ruggedness at 3.5 GHz¹

Symbol	Parameter	dB Compression	Typical
VSWR	Impedance Mismatch Ruggedness	3	10:1

Notes:

1. Test conditions unless otherwise noted: $T_A = 25\text{ °C}$, $V_D = 28\text{ V}$, $I_{DQ} = 260\text{ mA}$, 100 μS PW, 20% DC
2. Driving input power is determined at pulsed compression under matched condition at EVB output connector.

Maximum Gate Current

Maximum Gate Current Vs. IR Surface Temperature

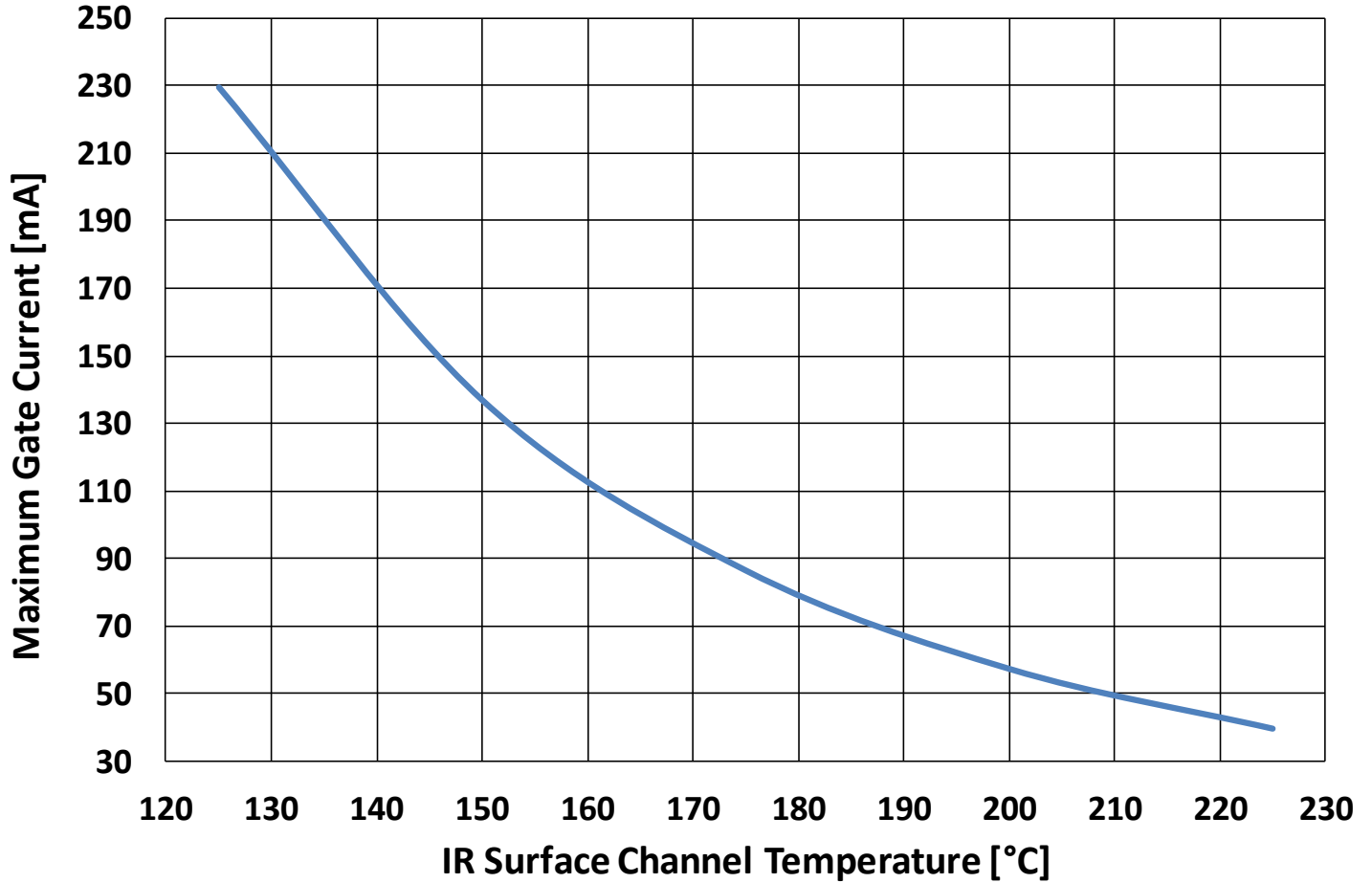

Thermal and Reliability Information – Pulsed

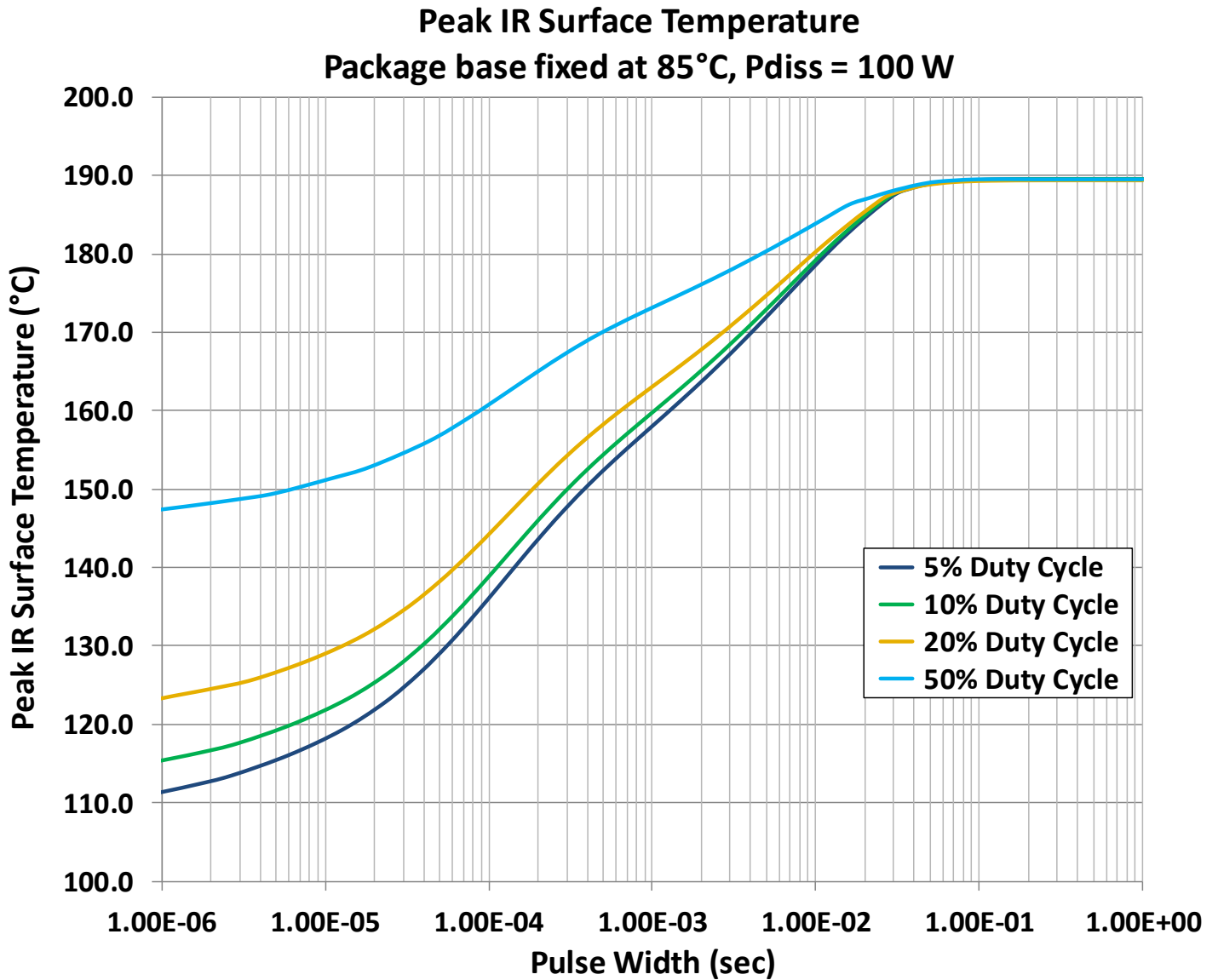

Parameter ¹	Conditions	Values	Units
Thermal Resistance, IR (θ_{JC})	85 °C back side temperature	0.73	°C/W
Peak IR Surface Temperature (T_{CH})	100 W Pdiss, 1 mS PW, 5% DC	158	°C
Thermal Resistance, IR (θ_{JC})	85 °C back side temperature	0.75	°C/W
Peak IR Surface Temperature (T_{CH})	100 W Pdiss, 1 mS PW, 10% DC	160	°C
Thermal Resistance, IR (θ_{JC})	85 °C back side temperature	0.78	°C/W
Peak IR Surface Temperature (T_{CH})	100 W Pdiss, 1 mS PW, 20% DC	163	°C
Thermal Resistance, IR (θ_{JC})	85 °C back side temperature	0.88	°C/W
Peak IR Surface Temperature (T_{CH})	100 W Pdiss, 1 mS PW, 25% DC	173	°C

¹Refer to the following document [GaN Device Channel Temperature, Thermal Resistance, and Reliability Estimates](#)

Thermal and Reliability Information – CW

Peak IR Surface Temperature vs. CW Power

Package base fixed at 85°C

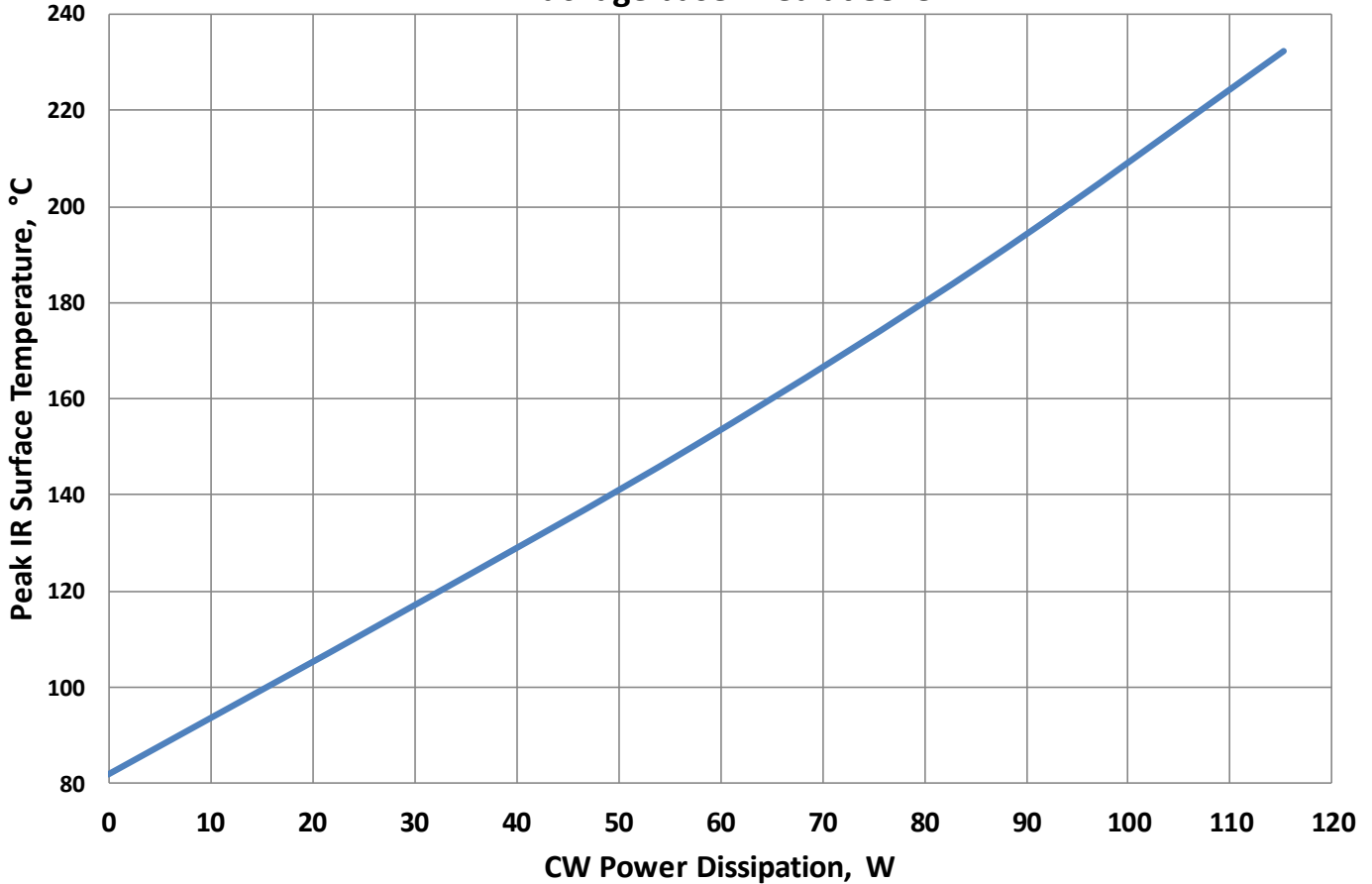

Parameter ¹	Conditions	Values	Units
Thermal Resistance, IR (θ_{JC})	85 °C back side temperature	1.08	°C/W
Peak IR Surface Temperature (T_{CH})	28.8 W Pdiss	116	°C
Thermal Resistance, IR (θ_{JC})	85 °C back side temperature	1.15	°C/W
Peak IR Surface Temperature (T_{CH})	57.6 W Pdiss	151	°C
Thermal Resistance, IR (θ_{JC})	85 °C back side temperature	1.20	°C/W
Peak IR Surface Temperature (T_{CH})	86.4 W Pdiss	189	°C
Thermal Resistance, IR (θ_{JC})	85 °C back side temperature	1.28	°C/W
Peak IR Surface Temperature (T_{CH})	115 W Pdiss	232	°C

¹Refer to the following document [GaN Device Channel Temperature, Thermal Resistance, and Reliability Estimates](#)

Load-Pull Smith Charts^{1,2}

Notes:

1. $V_D = 28\text{ V}$, $I_{DQ} = 260\text{ mA}$, $100\text{ }\mu\text{S PW}$, 20% DC pulsed. Performance is at 3dB gain compression referenced to peak gain.
2. See page 15 for load-pull and source-pull reference planes. $11.7\text{-}\Omega$ load-pull TRL fixtures are built with 20-mil RO4350B material.

1GHz, Load-pull

$Z_s(1fo) = 1.45 - 0.27i\Omega$
 $Z_s(2fo) = 6.54 + 24.95i\Omega$
 $Z_s(3fo) = 3.67 - 16.91i\Omega$

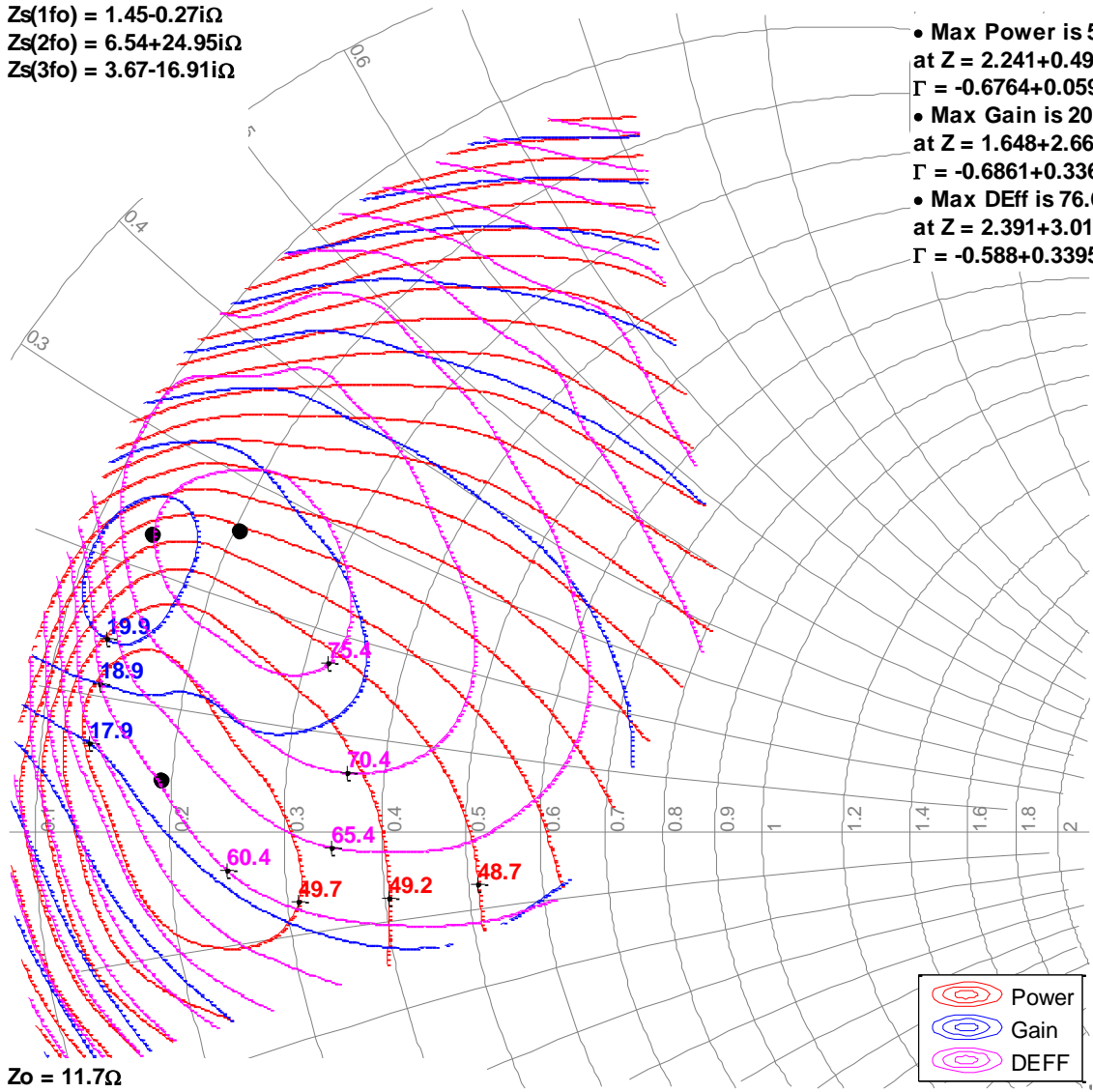

- Max Power is 50dBm at $Z = 2.241 + 0.492i\Omega$
 $\Gamma = -0.6764 + 0.0592i$
- Max Gain is 20.4dB at $Z = 1.648 + 2.661i\Omega$
 $\Gamma = -0.6861 + 0.3361i$
- Max DEff is 76.6% at $Z = 2.391 + 3.013i\Omega$
 $\Gamma = -0.588 + 0.3395i$

$Z_o = 11.7\Omega$
 3dB Compression Referenced to Peak Gain

Load-Pull Smith Charts^{1, 2}

Notes:

- $V_D = 28\text{ V}$, $I_{DQ} = 260\text{ mA}$, $100\text{ }\mu\text{S PW}$, 20% DC pulsed. Performance is at 3dB gain compression referenced to peak gain.
- See page 15 for load-pull and source-pull reference planes. $11.7\text{-}\Omega$ load-pull TRL fixtures are built with 20-mil RO4350B material.

2GHz, Load-pull

$Z_s(1f_0) = 1.33 - 4.22i\Omega$
 $Z_s(2f_0) = 1.06 + 1.79i\Omega$
 $Z_s(3f_0) = 2.31 + 1.72i\Omega$

- Max Power is 51.2dBm at $Z = 2.555 - 1.967i\Omega$
 $\Gamma = -0.6108 - 0.2223i$
- Max Gain is 15.1dB at $Z = 3.421 + 0.937i\Omega$
 $\Gamma = -0.5416 + 0.0955i$
- Max DEff is 66.9% at $Z = 1.679 - 0.781i\Omega$
 $\Gamma = -0.7431 - 0.1018i$

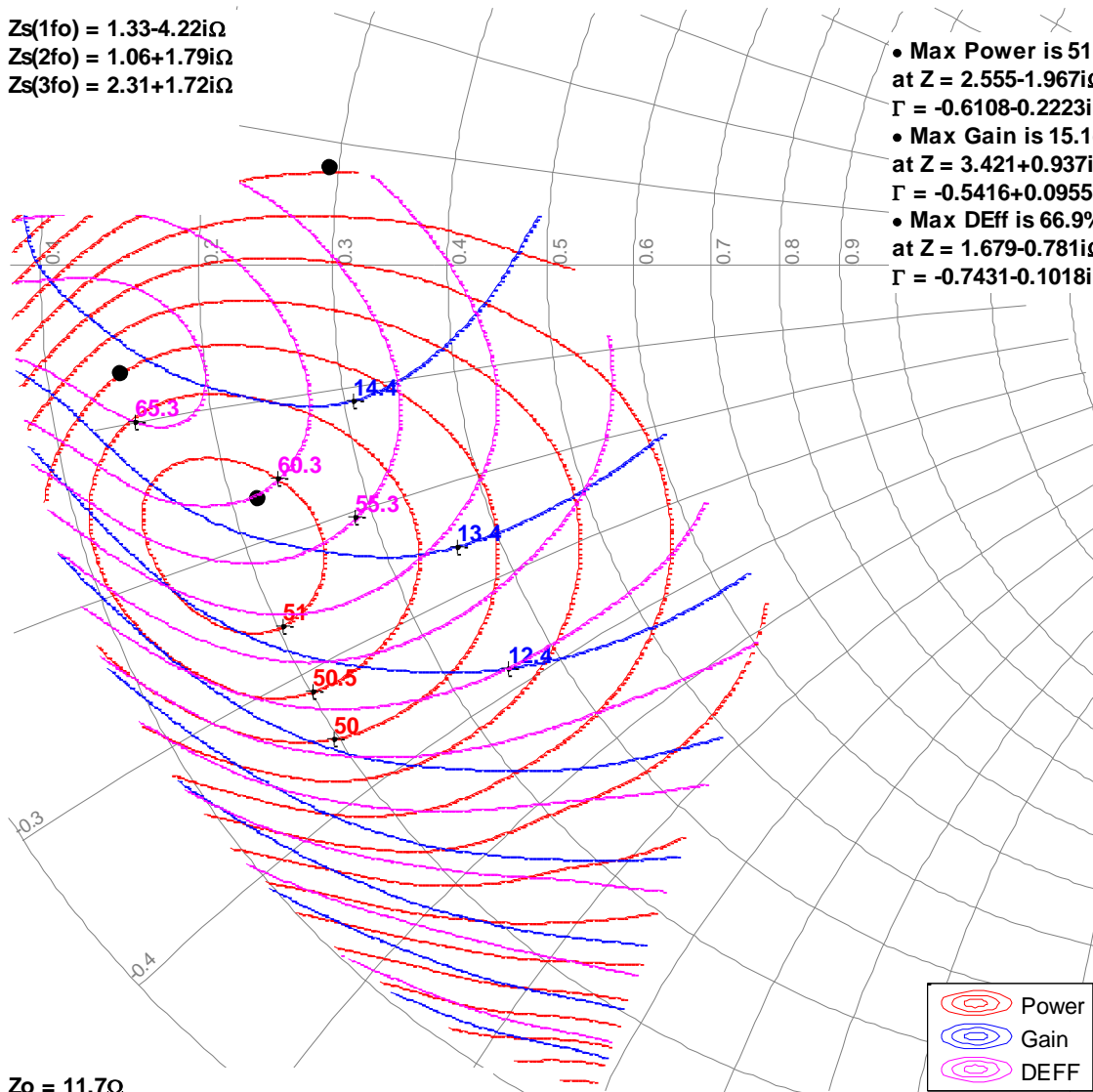

$Z_0 = 11.7\Omega$
 3dB Compression Referenced to Peak Gain

Load-Pull Smith Charts^{1, 2}

Notes:

1. $V_D = 28\text{ V}$, $I_{DQ} = 260\text{ mA}$, $100\ \mu\text{S PW}$, 20% DC pulsed. Performance is at 3dB gain compression referenced to peak gain.
2. See page 15 for load-pull and source-pull reference planes. $11.7\text{-}\Omega$ load-pull TRL fixtures are built with 20-mil RO4350B material.

3GHz, Load-pull

$Z_s(1fo) = 5.16-8.3i\Omega$
 $Z_s(2fo) = 3.73-4.83i\Omega$
 $Z_s(3fo) = 37.97-7.46i\Omega$

- Max Power is 50.8dBm at $Z = 2.794-4.043i\Omega$
 $\Gamma = -0.4979-0.4178i$
- Max Gain is 14.4dB at $Z = 1.705-1.63i\Omega$
 $\Gamma = -0.7202-0.2092i$
- Max DEff is 68.3% at $Z = 1.752-2.538i\Omega$
 $\Gamma = -0.6797-0.317i$

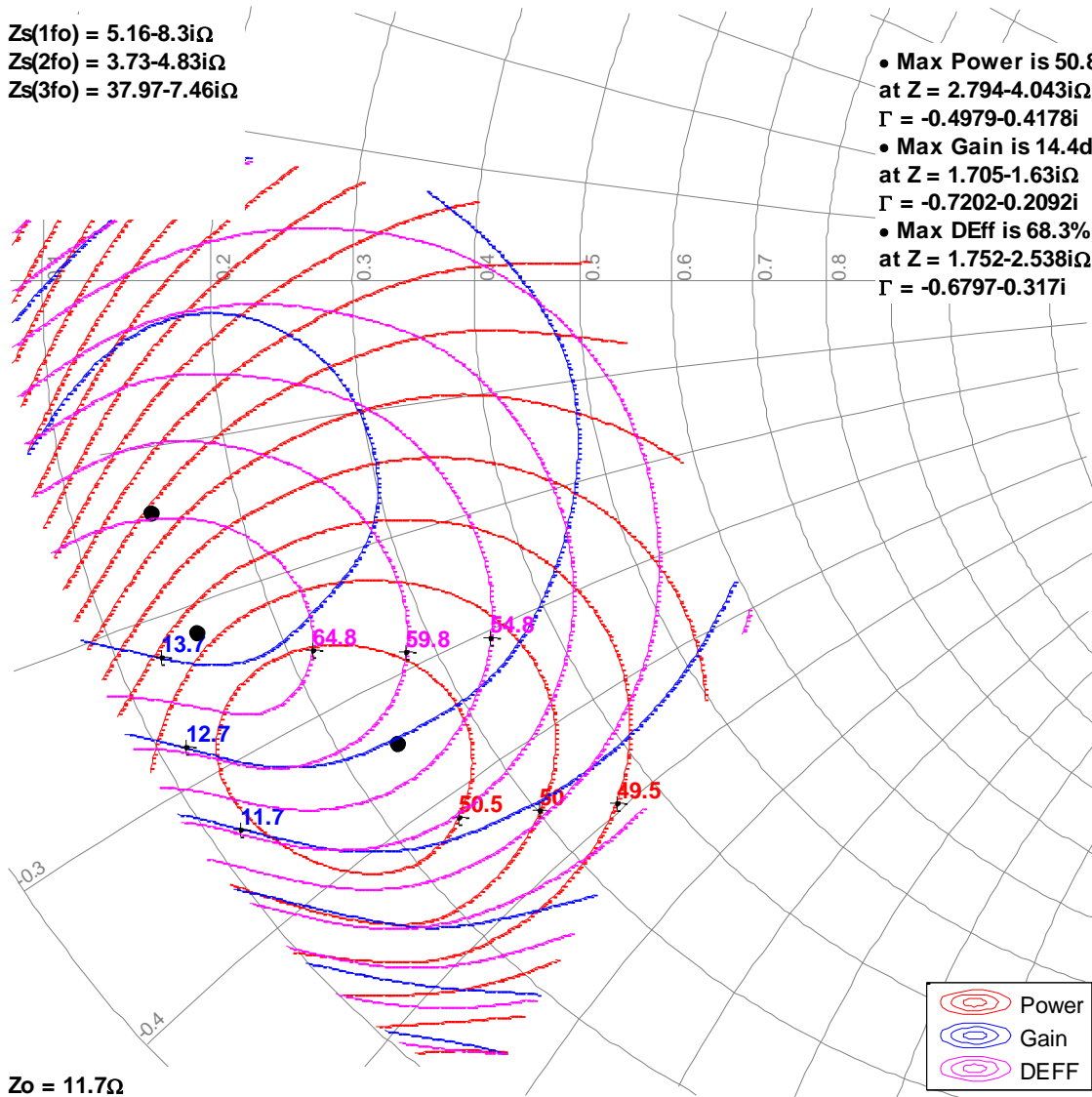

$Z_o = 11.7\Omega$
 3dB Compression Referenced to Peak Gain

Load-Pull Smith Charts^{1, 2}

Notes:

3. $V_D = 28\text{ V}$, $I_{DQ} = 260\text{ mA}$, $100\ \mu\text{S PW}$, 20% DC pulsed. Performance is at 3dB gain compression referenced to peak gain.
4. See page 15 for load-pull and source-pull reference planes. $11.7\text{-}\Omega$ load-pull TRL fixtures are built with 20-mil RO4350B material.

3.5GHz, Load-pull

$Z_s(1fo) = 13-0.58i\Omega$
 $Z_s(2fo) = 7.62+3.24i\Omega$
 $Z_s(3fo) = 41.24+12.78i\Omega$

- Max Power is 50.3dBm at $Z = 2.992-5.16i\Omega$
 $\Gamma = -0.4178-0.4979i$
- Max Gain is 14dB at $Z = 1.839-3.661i\Omega$
 $\Gamma = -0.6106-0.4355i$
- Max DEff is 60.8% at $Z = 1.839-3.661i\Omega$
 $\Gamma = -0.6106-0.4355i$

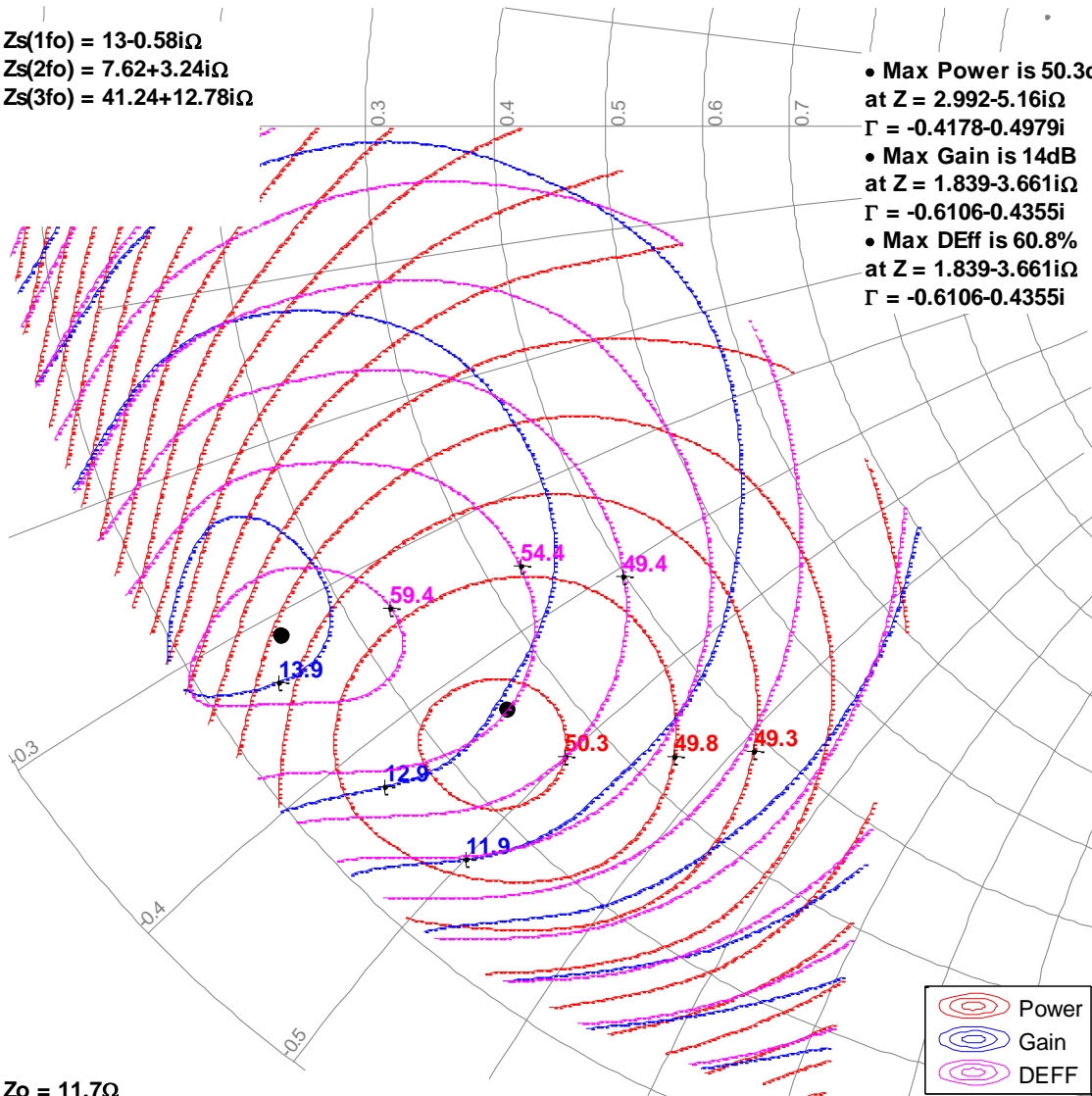

$Z_0 = 11.7\Omega$
 3dB Compression Referenced to Peak Gain

Typical Performance – Load-Pull Drive-up^{1, 2}

Notes:

1. 100 μ S PW, 20% DC pulsed signal, $V_D = 28$ V, $I_{DQ} = 260$ mA
2. See page 15 for load-pull and source-pull reference planes where the performance was measured.

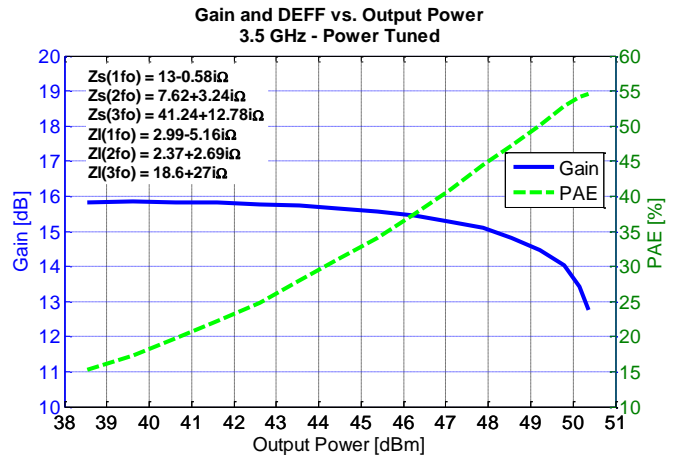
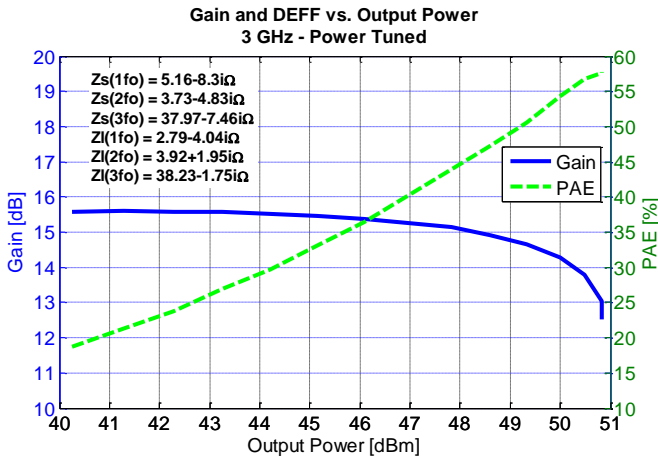
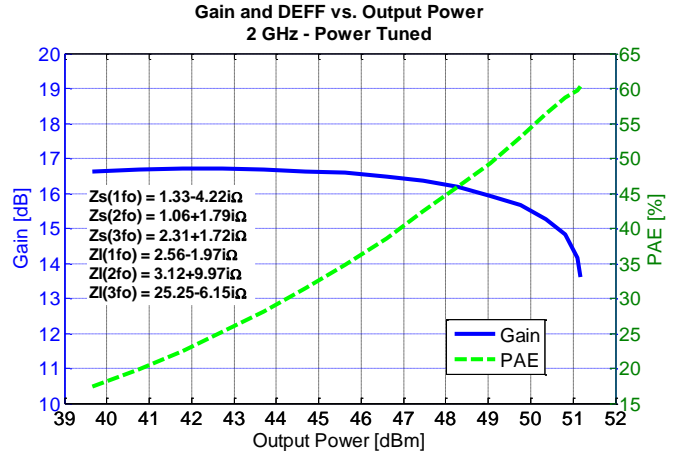
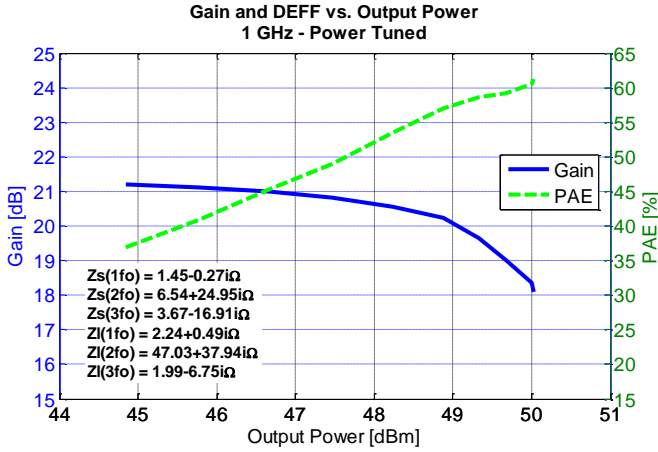



TGF2929-FL

100W, 28V, DC–3.5 GHz, GaN RF Power Transistor

Typical Performance – Load-Pull Drive-up^{1, 2}

Notes:

1. 100 μ S PW, 20% DC pulsed signal, $V_D = 28$ V, $I_{DQ} = 260$ mA
2. See page 15 for load-pull and source-pull reference planes where the performance was measured.

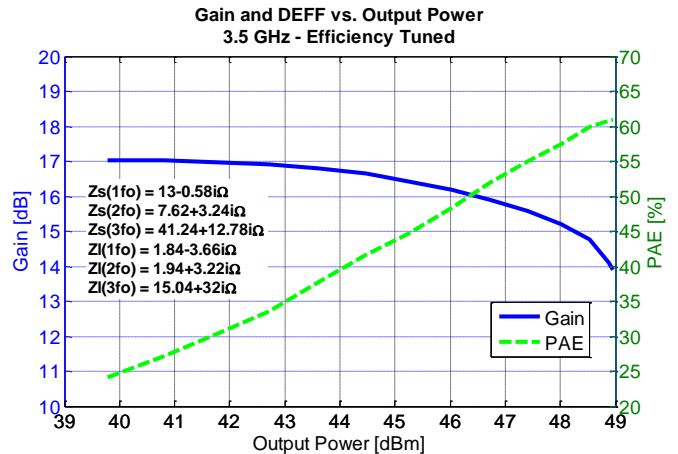
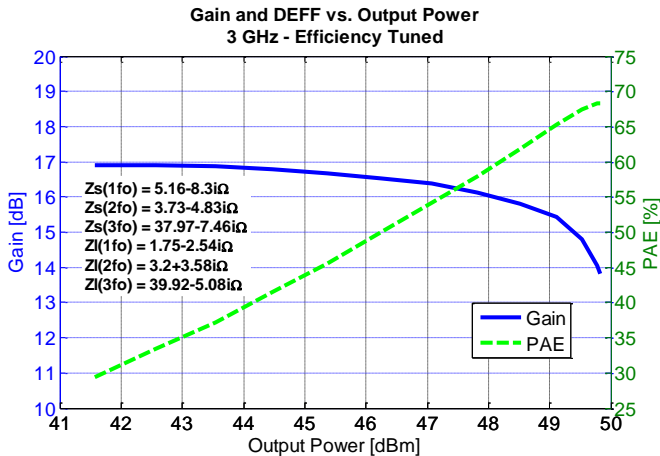
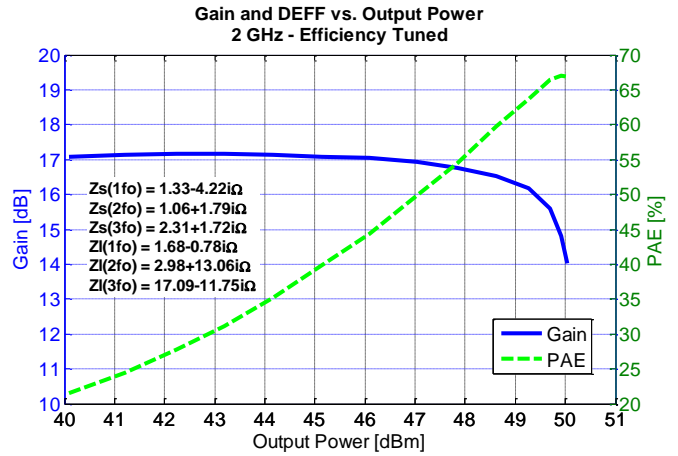
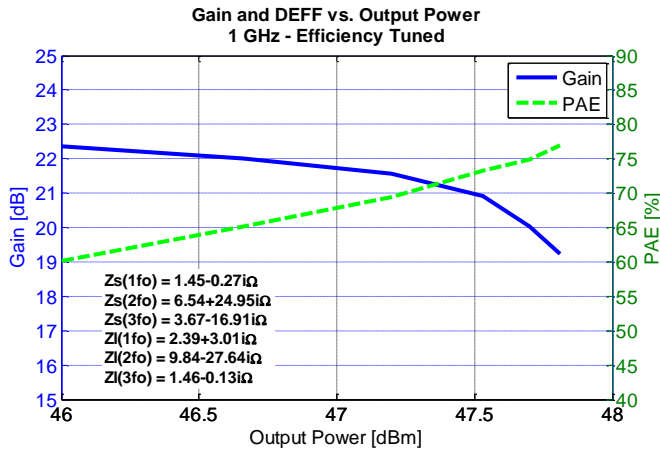

Power Drive-up Performance Over Temperatures Of 3.1 – 3.5 GHz EVB¹

Notes:

1. $V_D = 28\text{ V}$, $I_{DQ} = 260\text{ mA}$, $100\ \mu\text{S PW}$, 20% DC

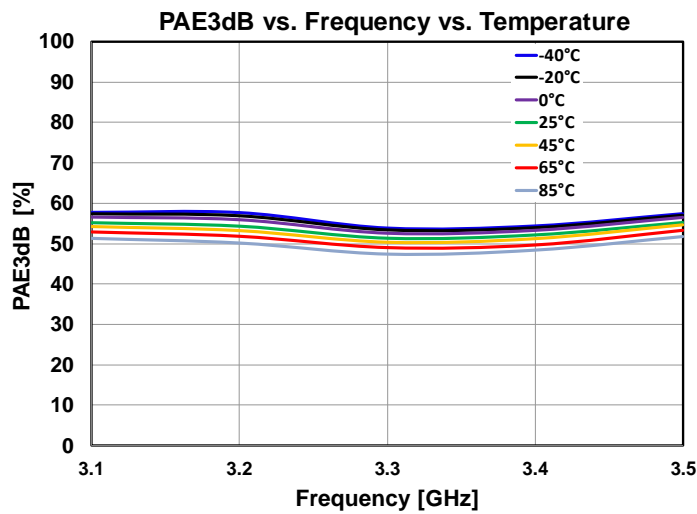
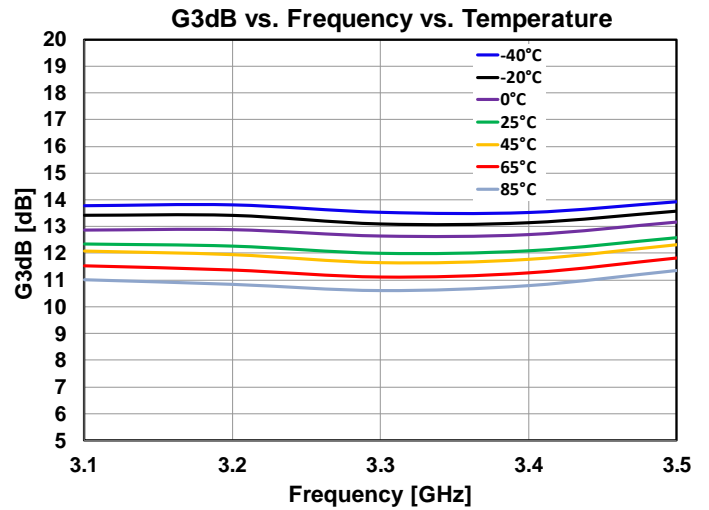
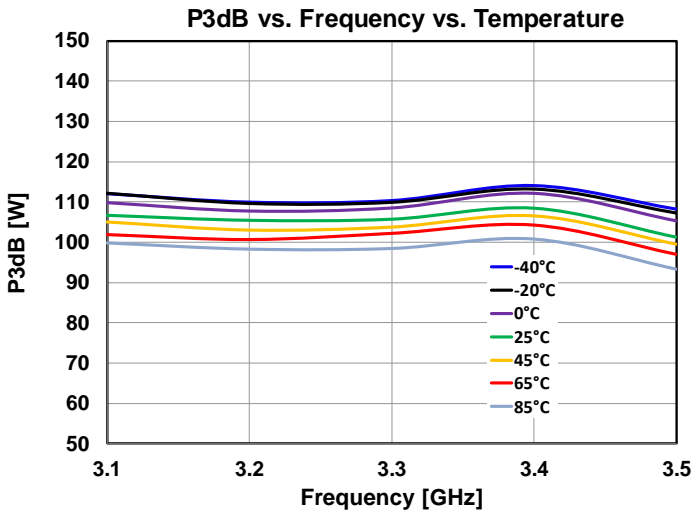



Power Drive-up Performance At 25 °C Of 3.1 – 3.5 GHz EVB¹

Notes:

1. $V_D = 28\text{ V}$, $I_{DQ} = 260\text{ mA}$, $100\ \mu\text{S PW}$, 20% DC

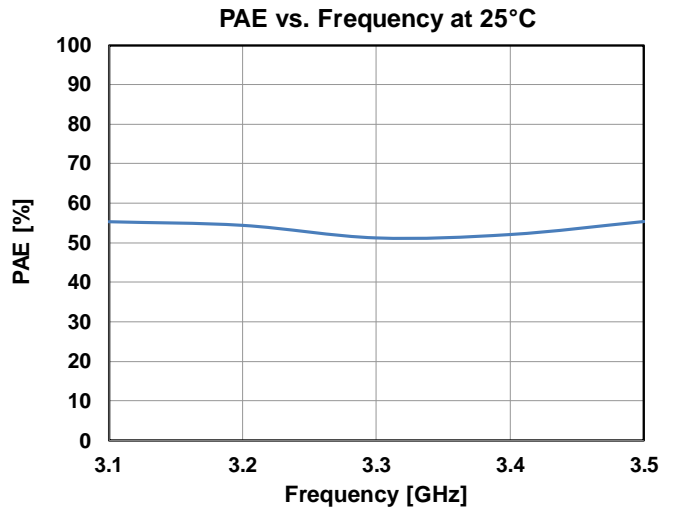
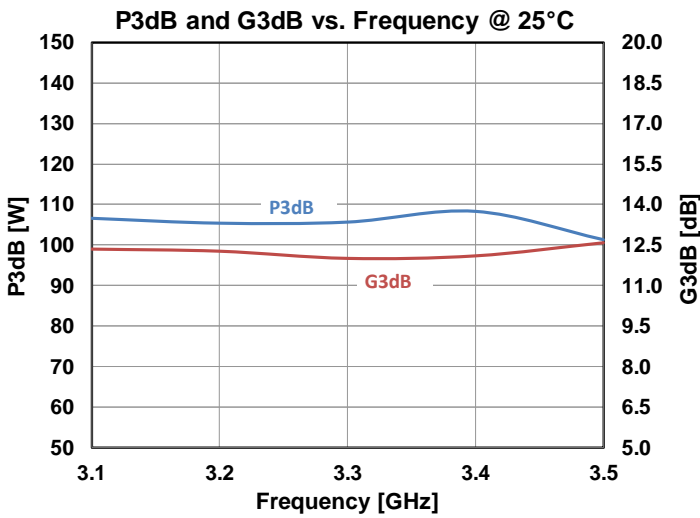

Pin Configuration and Description, and Package Marking¹

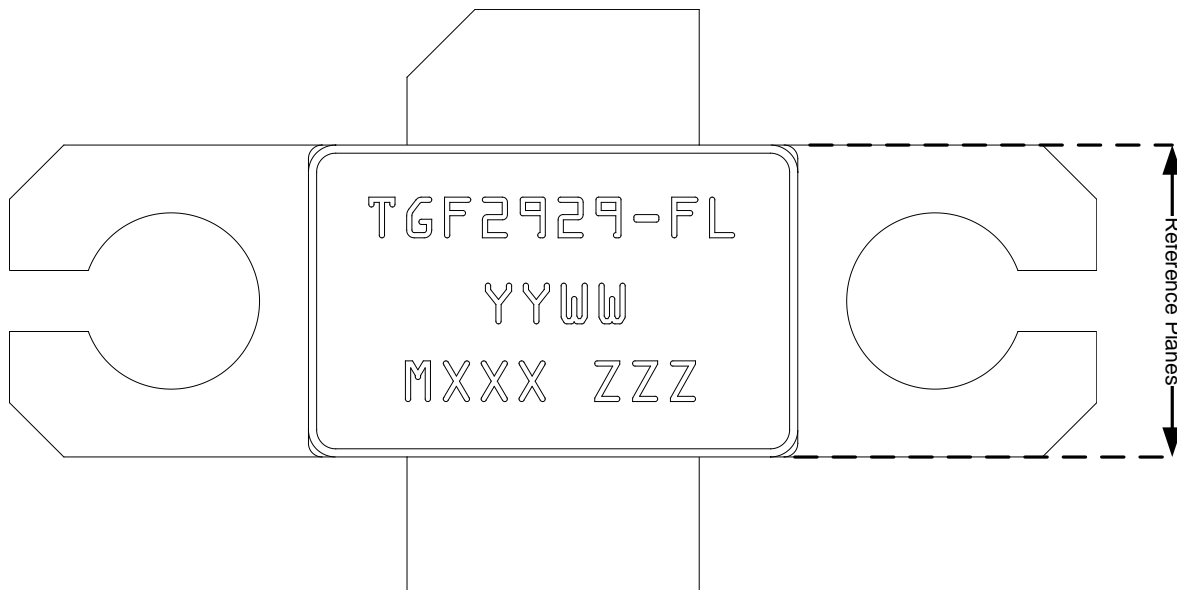

Notes:

1. The TGF2929-FL will be marked with the “TGF2929-FL” designator and a lot code marked below the part designator. The “YY” represents the last two digits of the calendar year the part was manufactured, the “WW” is the work week of the assembly lot start, the “MXXX” is the production lot number, and the “ZZZ” is an auto-generated serial number represents the last three digits of the calendar year the part was manufactured, the “WW” is the work week of the assembly lot start, the “MXXX” is the production lot number.

Pin Description

Pin	Symbol	Description
1	V_D / RF OUT	Drain voltage / RF Output
2	V_G / RF IN	Gate voltage / RF Input
3	Base	Source connected to ground

Package Dimensions^{1, 2, 3, 4}

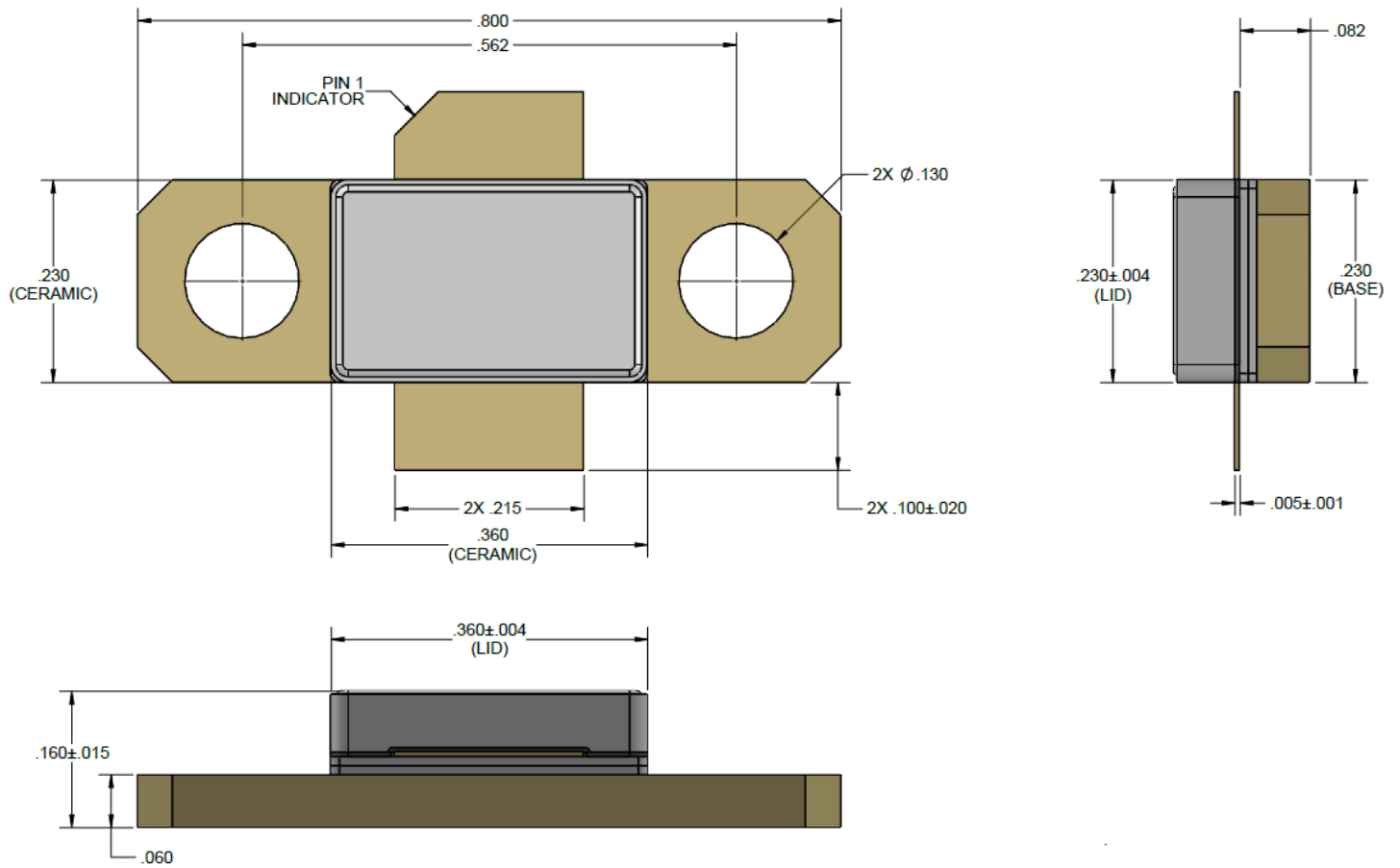

Notes:

1. Unless otherwise noted, the tolerance is ± 0.005 inch.
2. Package metal base and leads are gold plated.
3. Part is epoxy sealed.
4. Part meets Industry NI360 footprint.

Schematic – 3.1 – 3.5 GHz EVB

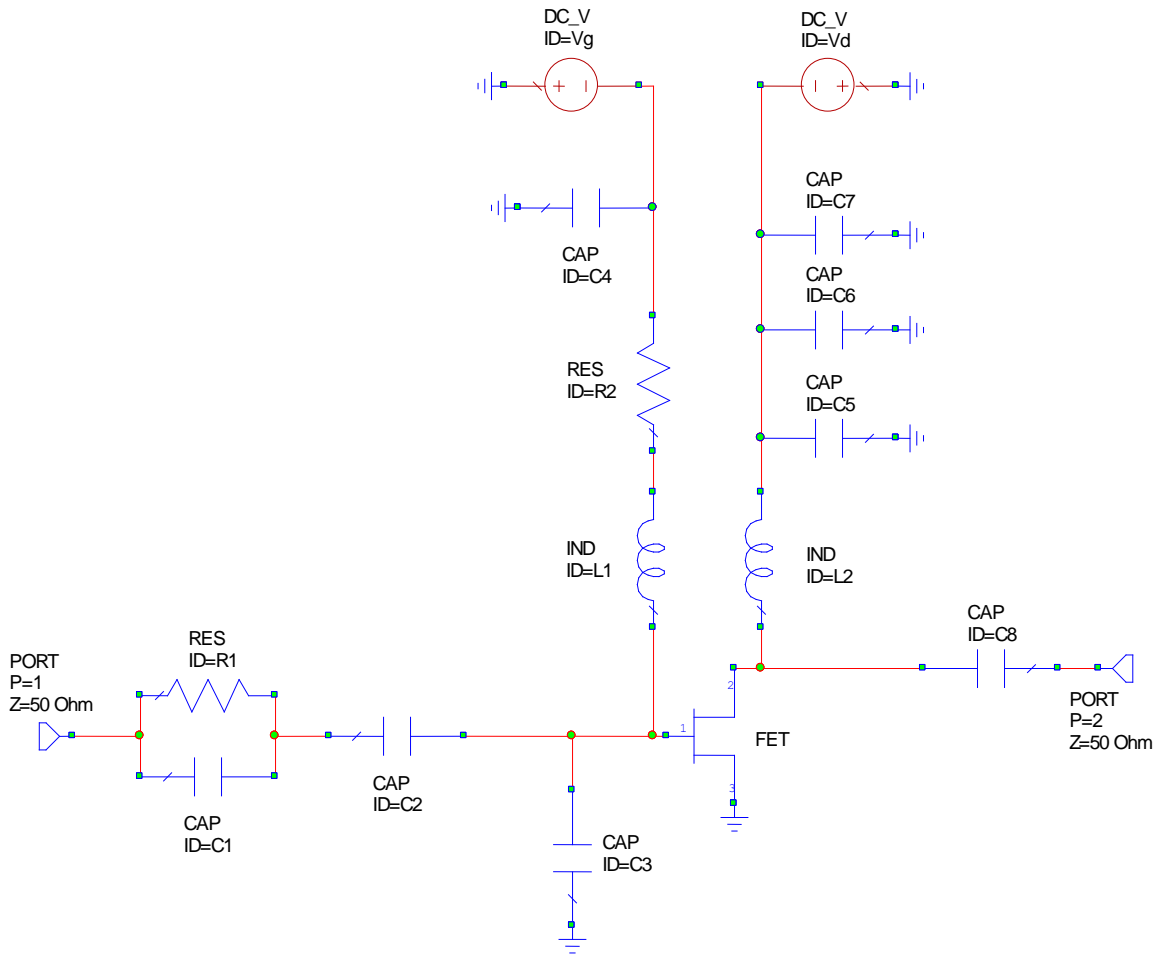

Bias-up Procedure

1. Set V_G to -4 V.
2. Set I_D current limit to 300 mA.
3. Apply 28 V V_D .
4. Slowly adjust V_G until I_D is set to 260 mA.
5. Set I_D current limit to 2 A
6. Apply RF.

Bias-down Procedure

1. Turn off RF signal.
2. Turn off V_D
3. Wait 2 seconds to allow drain capacitor to discharge
4. Turn off V_G

3.1 – 3.5 GHz EVB¹

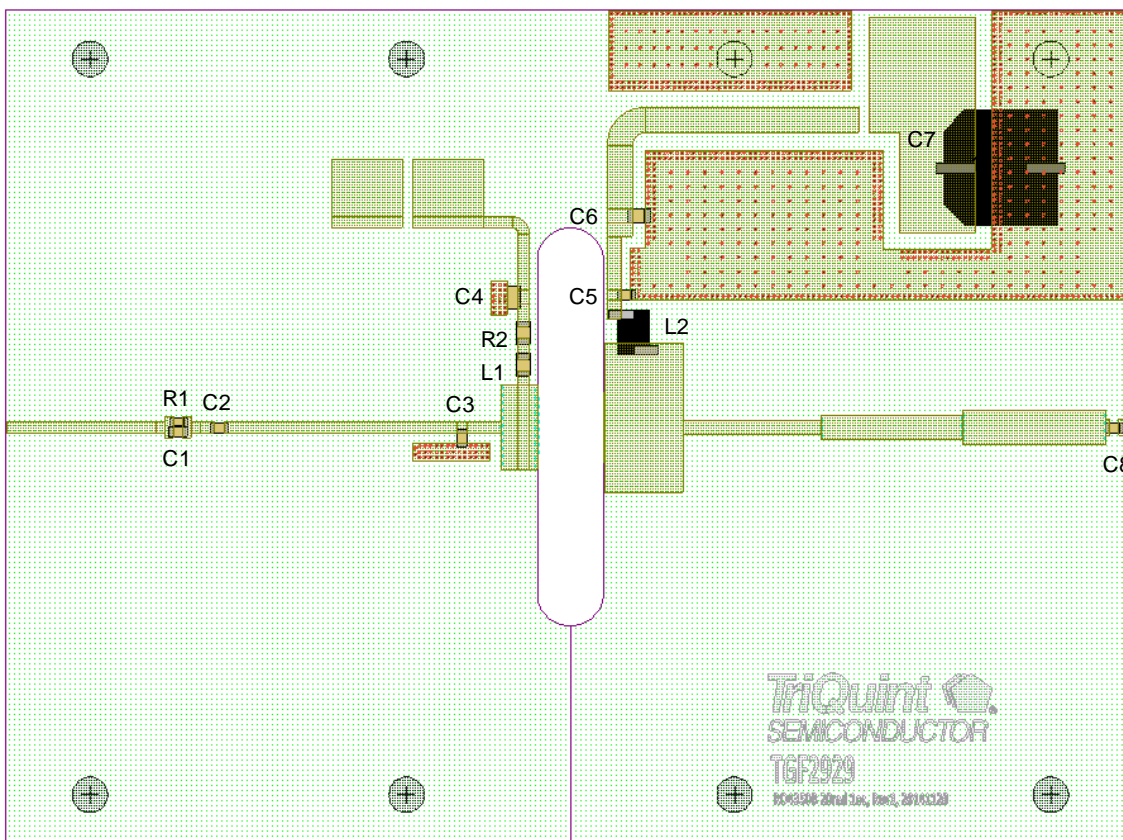

Notes:

1. PCB Material: RO4350B, 20 mil thickness, 1 oz copper cladding

Bill of material – 3.1 – 3.5 GHz EVB

Ref Des	Value	Qty	Manufacturer	Part Number
R1	100 Ω	1	Vishay/Dale	CRCW0603100RJNEA
C1, C2	5.6 pF	2	ATC	600S5R6BT
C3	1.0 pF	1	ATC	600S1R0BT
L1	22 nH	1	Coilcraft	0805CS-220X-LB
R2	10 Ω	1	Vishay/Dale	CRCW060310R0JNEA
C4	10 μ F	1	Murata	C1632X5R0J106M130AC
L2	12 nH	1	Coilcraft	A04T_L
C5	2400 pF	1	Murata	C08BL242X-5UN-X0T
C6	1000 pF	1	ATC	800B102JT50XT
C7	220 μ F	1	United Chemi-Con	EMVY500ADA221MJA0G
C8	15 pF	1	ATC	600S150JT250XT

Recommended Solder Temperature Profile

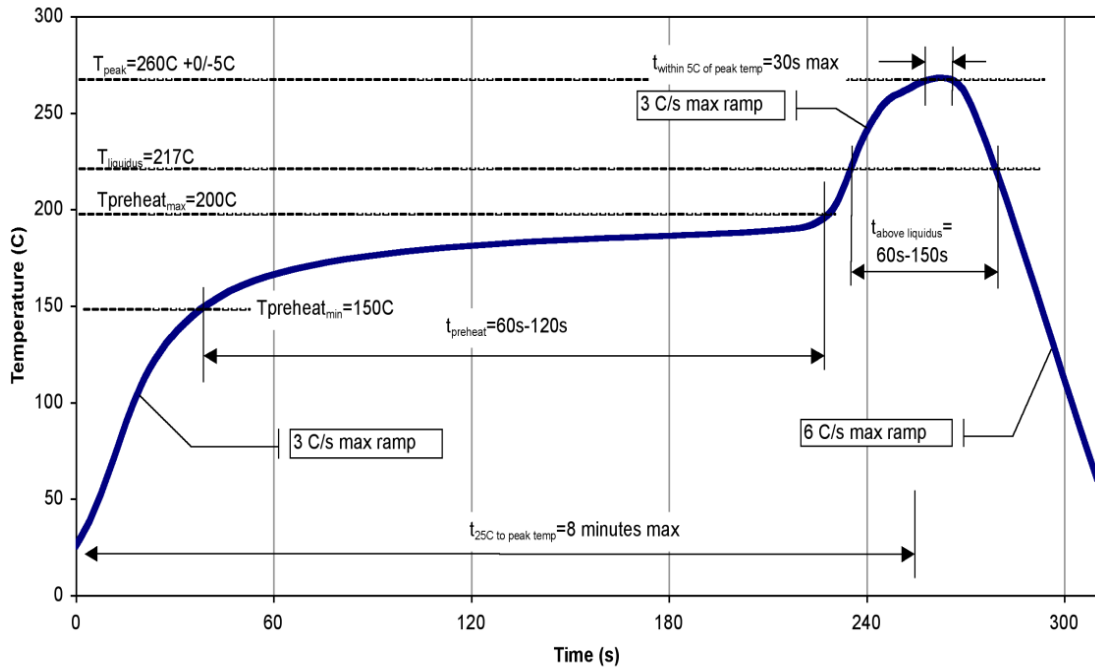



TGF2929-FL 100W, 28V, DC–3.5 GHz, GaN RF Power Transistor

Handling Precautions

Parameter	Rating	Standard
ESD – Human Body Model (HBM)	Class 1A 650 V	ANSI/ESD/JEDEC JS-001
ESD – Charged Device Model (CDM)	Class C3 1000 V	ANSI/ESD/JEDEC JS-002



Caution!
ESD-Sensitive Device

Solderability

Compatible with both lead-free (260°C max. reflow temp.) and tin/lead (245°C max. reflow temp.) soldering processes. Solder profiles available upon request.

Package lead plating is NiAu. Au thickness is 60 microinches.

RoHS Compliance

This part is compliant with 2011/65/EU RoHS directive (Restrictions on the Use of Certain Hazardous Substances in Electrical and Electronic Equipment) as amended by Directive 2015/863/EU.

This product also has the following attributes:

- Lead Free
- Halogen Free (Chlorine, Bromine)
- Antimony Free
- TBBP-A (C₁₅H₁₂Br₄O₂) Free
- PFOS Free
- SVHC Free



Contact Information

For the latest specifications, additional product information, worldwide sales and distribution locations:

Web: www.qorvo.com **Tel:** +1.844.890.8163
Email: customer.support@qorvo.com

For technical questions and application information: **Email:** info-products@qorvo.com

Important Notice

The information contained herein is believed to be reliable; however, Qorvo makes no warranties regarding the information contained herein and assumes no responsibility or liability whatsoever for the use of the information contained herein. All information contained herein is subject to change without notice. Customers should obtain and verify the latest relevant information before placing orders for Qorvo products. The information contained herein or any use of such information does not grant, explicitly or implicitly, to any party any patent rights, licenses, or any other intellectual property rights, whether with regard to such information itself or anything described by such information. **THIS INFORMATION DOES NOT CONSTITUTE A WARRANTY WITH RESPECT TO THE PRODUCTS DESCRIBED HEREIN, AND QORVO HEREBY DISCLAIMS ANY AND ALL WARRANTIES WITH RESPECT TO SUCH PRODUCTS WHETHER EXPRESS OR IMPLIED BY LAW, COURSE OF DEALING, COURSE OF PERFORMANCE, USAGE OF TRADE OR OTHERWISE, INCLUDING THE IMPLIED WARRANTIES OF MERCHANTABILITY AND FITNESS FOR A PARTICULAR PURPOSE.**

Without limiting the generality of the foregoing, Qorvo products are not warranted or authorized for use as critical components in medical, life-saving, or life-sustaining applications, or other applications where a failure would reasonably be expected to cause severe personal injury or death.

Copyright 2016 © Qorvo, Inc. | Qorvo is a registered trademark of Qorvo, Inc.

X-ON Electronics

Largest Supplier of Electrical and Electronic Components

Click to view similar products for [RF Development Tools](#) category:

Click to view products by [Qorvo](#) manufacturer:

Other Similar products are found below :

[MAAM-011117](#) [MAAP-015036-DIEEV2](#) [EV1HMC1113LP5](#) [EV1HMC6146BLC5A](#) [EV1HMC637ALP5](#) [EVAL-ADG919EBZ](#) [ADL5363-EVALZ](#) [LMV228SDEVAL](#) [SKYA21001-EVB](#) [SMP1331-085-EVB](#) [EV1HMC618ALP3](#) [EVAL01-HMC1041LC4](#) [MAAL-011111-000SMB](#)
[MAAM-009633-001SMB](#) [MASW-000936-001SMB](#) [107712-HMC369LP3](#) [107780-HMC322ALP4](#) [SP000416870](#) [EV1HMC470ALP3](#)
[EV1HMC520ALC4](#) [EV1HMC244AG16](#) [MAX2614EVKIT#](#) [124694-HMC742ALP5](#) [SC20ASATEA-8GB-STD](#) [MAX2837EVKIT+](#)
[MAX2612EVKIT#](#) [MAX2692EVKIT#](#) [EV1HMC629ALP4E](#) [SKY12343-364LF-EVB](#) [108703-HMC452QS16G](#) [EV1HMC863ALC4](#)
[EV1HMC427ALP3E](#) [119197-HMC658LP2](#) [EV1HMC647ALP6](#) [ADL5725-EVALZ](#) [MAX2371EVKIT#](#) [106815-HMC441LM1](#)
[EV1HMC1018ALP4](#) [UXN14M9PE](#) [MAX2016EVKIT](#) [EV1HMC939ALP4](#) [MAX2410EVKIT](#) [MAX2204EVKIT+](#) [EV1HMC8073LP3D](#)
[SIMSA868-DKL](#) [SIMSA868C-DKL](#) [SKY65806-636EK1](#) [SKY68020-11EK1](#) [SKY67159-396EK1](#) [SKY66181-11-EK1](#)