

Product Overview

The Qorvo TGF3015-SM is a 10W (P_{3dB}), 50 Ω -input matched discrete GaN on SiC HEMT which operates from 30 MHz to 3.0 GHz. The integrated input matching network enables wideband gain and power performance, while the output can be matched on board to optimize power and efficiency for any region within the band.

The device is housed in an industry-standard 3 x 3 mm package that saves real estate in space-constrained handheld radios.

Lead-free and ROHS compliant

Evaluation boards are available upon request.

Functional Block Diagram

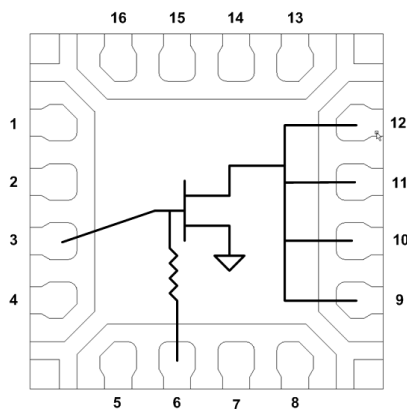

Pin Configuration

Pin No.	Label
9 - 12	V_D / RF OUT
3	V_G / RF IN
6	Off-chip Shunt Cap for Low-Frequency Gain
Back side	Source

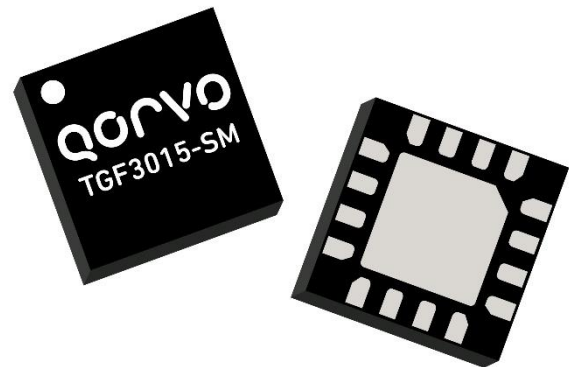

Key Features

- Frequency: 30 MHz to 3.0 GHz
- Output Power (P_{3dB}): 11 W at 2.4 GHz
- Linear Gain: 17.1 dB at 2.4 GHz
- Typical PAE_{3dB}: 62.7% at 2.4 GHz
- Operating Voltage: 32 V
- Low thermal resistance package
- CW and Pulse capable
- 3 x 3 mm package

Applications

- Military radar
- Civilian radar
- Land mobile and military radio communications
- Test instrumentation
- Wideband or narrowband amplifiers
Jammers

Ordering info

Part No.	Description
TGF3015-SM	QFN Packaged Part
TGF3015-SMEVB1	0.5 – 3 GHz EVB

Absolute Maximum Ratings ^{1, 2, 3}

Parameter	Rating	Units
Breakdown Voltage, BV_{DG}	100	V
Gate Voltage Range, V_G	-50 to 0	V
Drain Current, $I_{D_{MAX}}$	1.5	A
Gate Current Range, I_G	-2.5 to 4.2	mA
Power Dissipation, Pulsed, P_{DISS}^2	15	W
RF Input Power, CW, $T = 25^\circ\text{C}$ (P_{IN})	27.5	dBm
Mounting Temperature (30 Seconds)	320	$^\circ\text{C}$
Storage Temperature	-40 to +150	$^\circ\text{C}$

Notes:

1. Operation of this device outside the parameter ranges given above may cause permanent damage
2. Pulsed, 100us PW, 20% DC, Package base at 85 $^\circ\text{C}$
3. Pulsed, 100us PW, 20% DC, $T = 25^\circ\text{C}$

Recommended Operating Conditions ¹

Parameter	Min	Typ	Max	Units
Gate Voltage, V_G	-	-2.7	-	V
Drain Voltage Range, V_D		32		V
Drain Bias Current, I_{DQ}	-	50	-	mA

Notes:

1. Electrical performance is measured under conditions noted in the electrical specifications table. Specifications are not guaranteed over all recommended operating conditions

RF Characterization – Load Pull Performance at 1.0 GHz ¹

Parameter	Min	Typ	Max	Units
Linear Gain, G_{LIN}	-	16.2	-	dB
Output Power at 3dB compression point, P_{3dB}	-	40.2	-	dBm
Power-Added Efficiency at 3 dB Gain Compression, Efficiency Tuned, PAE_{3dB}	-	70.9	-	%
Gain at 3dB compression point, G_{3dB}	-	13.2	-	dB

Notes:

1. $V_D = 32\text{ V}$, $I_{DQ} = 50\text{ mA}$, $T_A = 25^\circ\text{C}$, Pulse Width = 100 us, Duty Cycle = 20%

RF Characterization – Load Pull Performance at 2.0 GHz ¹

Parameter	Min	Typ	Max	Units
Linear Gain, G_{LIN}	-	16.5	-	dB
Output Power at 3dB compression point, P_{3dB}	-	40.6	-	dBm
Power-Added Efficiency at 3 dB Gain Compression, Efficiency Tuned, PAE_{3dB}	-	61.7	-	%
Gain at 3dB compression point, G_{3dB}	-	13.5	-	dB

Notes:

1. $V_D = 32\text{ V}$, $I_{DQ} = 50\text{ mA}$, $T_A = 25^\circ\text{C}$, Pulse Width = 100 us, Duty Cycle = 20%

RF Characterization – Load Pull Performance at 2.4 GHz ¹

Parameter	Min	Typ	Max	Units
Linear Gain, G_{LIN}	–	17.1	–	dB
Output Power at 3 dB Gain Compression, Power Tuned, P_{3dB}	–	40.4	–	dBm
Power-Added Efficiency at 3 dB Gain Compression, Efficiency Tuned, PAE_{3dB}	–	62.7	–	%
Gain at 3dB compression point, Power Tuned, G_{3dB}	–	14.1	–	dB

Notes:

- $V_D = 32\text{ V}$, $I_{DQ} = 50\text{ mA}$, $T_A = 25\text{ °C}$, Pulse Width = 100 us, Duty Cycle = 20%

RF Characterization – Load Pull Performance at 2.7 GHz ¹

Parameter	Min	Typ	Max	Units
Linear Gain, G_{LIN}	–	16.3	–	dB
Output Power at 3 dB Gain Compression, Power Tuned, P_{3dB}	–	40.5	–	dBm
Power-Added Efficiency at 3 dB Gain Compression, Efficiency Tuned, PAE_{3dB}	–	63.7	–	%
Gain at 3dB compression point, Power Tuned, G_{3dB}	–	13.3	–	dB

Notes:

- $V_D = 32\text{ V}$, $I_{DQ} = 50\text{ mA}$, $T_A = 25\text{ °C}$, Pulse Width = 100 us, Duty Cycle = 20%

RF Characterization – Load Pull Performance at 3.0 GHz ¹

Parameter	Min	Typ	Max	Units
Linear Gain, G_{LIN}	–	15.4	–	dB
Output Power at 3dB compression point, Power Tuned, P_{3dB}	–	40.5	–	dBm
Power-Added Efficiency at 3 dB Gain Compression, Efficiency Tuned, PAE_{3dB}	–	58.6	–	%
Gain at 3dB compression point, Power Tuned, G_{3dB}	–	12.4	–	dB

Notes:

- $V_D = 32\text{ V}$, $I_{DQ} = 50\text{ mA}$, $T_A = 25\text{ °C}$, Pulse Width = 100 us, Duty Cycle = 20%

RF Characterization – EVB Performance at 2.4 GHz ¹

Parameter	Min	Typ	Max	Units
Linear Gain, G_{LIN}	–	16.3	–	dB
Output Power at 3dB compression point, P3dB	–	40.5	–	dBm
Drain Efficiency at 3dB compression point, DEFF3dB	–	63.7	–	%
Gain at 3dB compression point, G3dB	–	13.3	–	dB
Gate Leakage $V_D = +10\text{ V}, V_G = -3.7\text{ V}$	-2.8	–	–	mA

Notes:

1. $V_D = 32\text{ V}, I_{DQ} = 50\text{ mA}, T_A = 25\text{ }^\circ\text{C}, \text{Pulse Width} = 100\text{ }\mu\text{s}, \text{Duty Cycle} = 20\%$

RF Characterization – Mismatch Ruggedness at 3.0 GHz ^{1, 2, 3}

Symbol	Parameter	dB Compression	Typical
VSWR	Impedance Mismatch Ruggedness	3	10:1

Notes:

1. Test conditions unless otherwise noted: $T_A = 25\text{ }^\circ\text{C}, V_D = 32\text{ V}, I_{DQ} = 50\text{ mA}$
2. Input drive power is determined at pulsed 3dB compression under matched condition at EVB output connector
3. Pulse: 100us, 20% Duty cycle

Thermal and Reliability Information – CW ^{1, 2}

Parameter	Test Conditions	Value	Units
Thermal Resistance, IR (θ_{JC})	Vds = 32V, Idq = 50mA 85 °C Case	7.76	°C/W
Channel Temperature, IR (T_{CH})	2.5 W Pdiss, CW	104.40	°C
Thermal Resistance, IR (θ_{JC})	Vds = 32V, Idq = 50mA 85 °C Case	8.37	°C/W
Channel Temperature, IR (T_{CH})	5 W Pdiss, CW	126.85	°C
Thermal Resistance, IR (θ_{JC})	Vds = 32V, Idq = 50mA 85 °C Case	8.73	°C/W
Channel Temperature, IR (T_{CH})	7.5 W Pdiss, CW	150.44	°C
Thermal Resistance, IR (θ_{JC})	Vds = 32V, Idq = 50mA 85 °C Case	9.13	°C/W
Channel Temperature, IR (T_{CH})	10 W Pdiss, CW	176.34	°C
Thermal Resistance, IR (θ_{JC})	Vds = 32V, Idq = 50mA 85 °C Case	9.67	°C/W
Channel Temperature, IR (T_{CH})	12.5 W Pdiss, CW	205.87	°C

Notes:

1. Thermal resistance measured to bottom of package.
2. Refer to the following document: [GaN Device Channel Temperature, Thermal Resistance, and Reliability Estimates](#)

Thermal and Reliability Information – Pulsed ^{1, 2}

Parameter	Test Conditions	Value	Units
Thermal Resistance, IR (θ_{JC})	Vds = 32V, Idq = 50mA 85 °C Case	5.68	°C/W
Channel Temperature, IR (T_{CH})	10 W Pdiss, 100uS PW, 20%	141.77	°C
Thermal Resistance, IR (θ_{JC})	Vds = 32V, Idq = 50mA 85 °C Case	5.77	°C/W
Channel Temperature, IR (T_{CH})	12.5 W Pdiss, 100uS PW, 20%	157.08	°C
Thermal Resistance, IR (θ_{JC})	Vds = 32V, Idq = 50mA 85 °C Case	5.86	°C/W
Channel Temperature, IR (T_{CH})	15 W Pdiss, 100uS PW, 20%	172.90	°C

Notes:

1. Thermal resistance measured to bottom of package.
2. Refer to the following document: [GaN Device Channel Temperature, Thermal Resistance, and Reliability Estimates](#)

Load Pull Contours 1, 2, 3

Notes:

1. Test Conditions: $V_D = 32\text{ V}$, $I_{DQ} = 50\text{ mA}$, 100 us Pulse Width, 20% Duty Cycle.
2. 3dB Compression referenced at peak gain.
3. See "Pin Configuration and Description" for load pull and source pull reference planes.

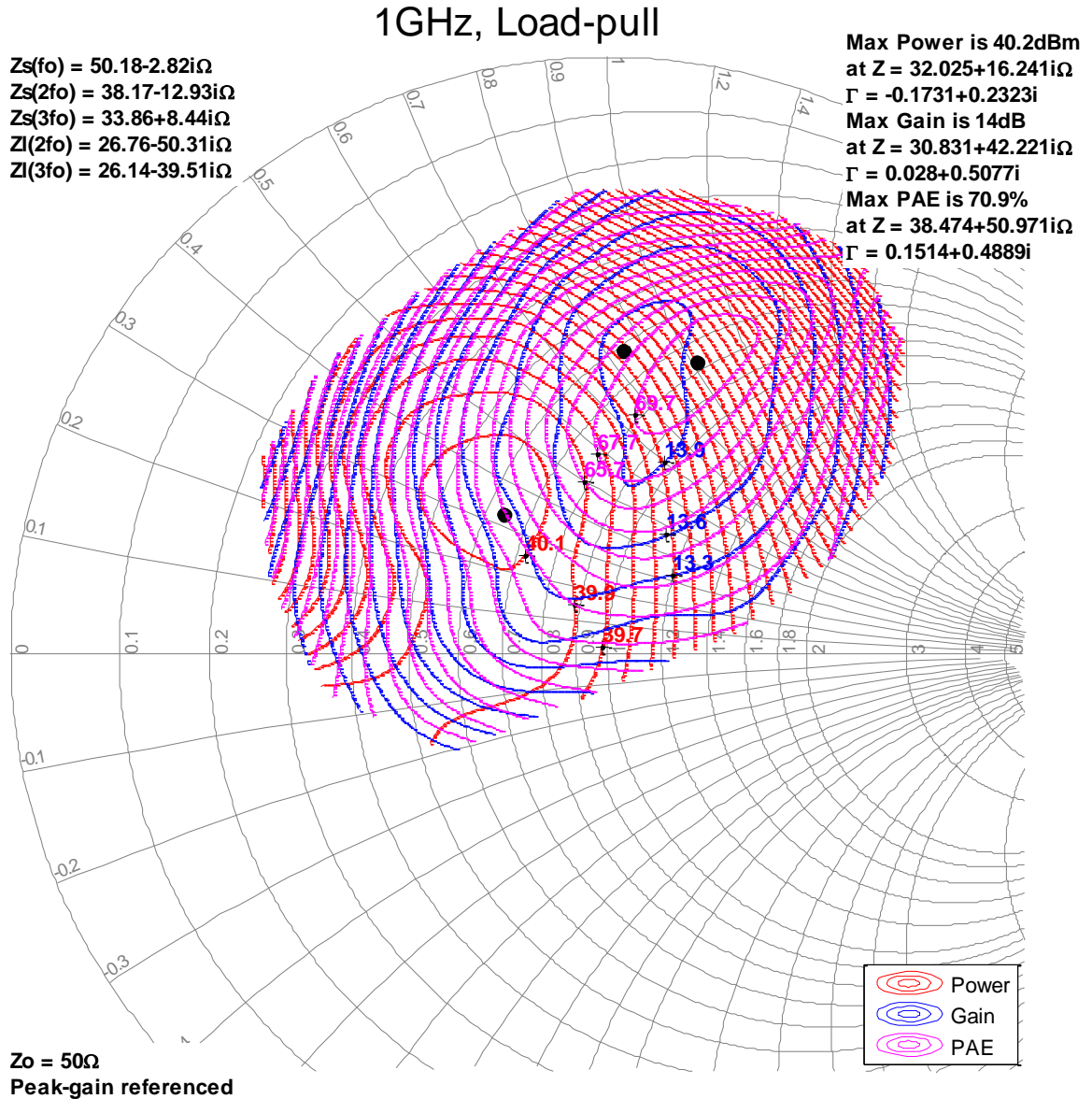

Load Pull Contours 1, 2, 3

Notes:

1. Test Conditions: $V_D = 32\text{ V}$, $I_{DQ} = 50\text{ mA}$, 100 us Pulse Width, 20% Duty Cycle.
2. 3dB Compression referenced at peak gain.
3. See "Pin Configuration and Description" for load pull and source pull reference planes.

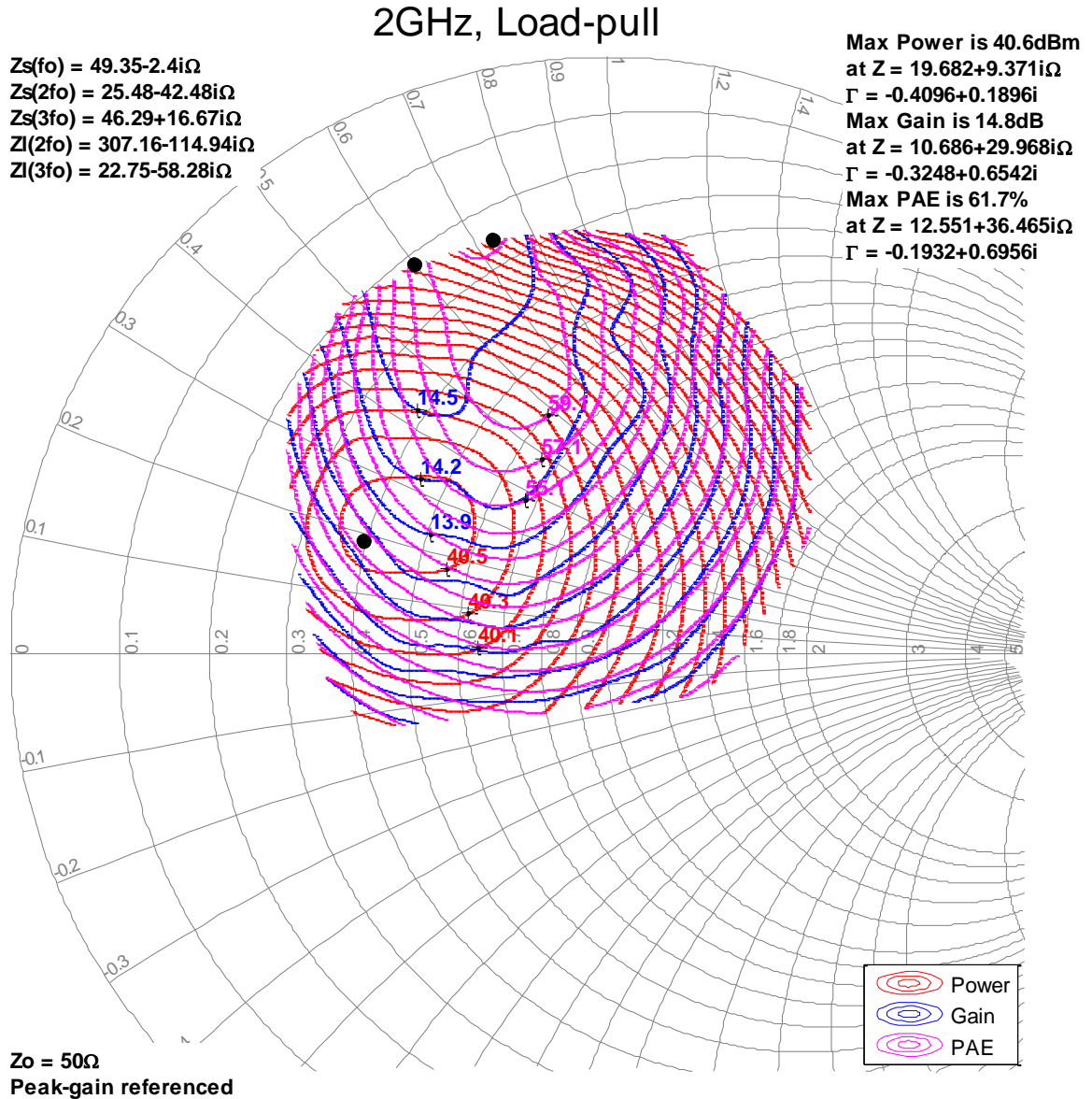

Load Pull Contours 1, 2, 3

Notes:

1. Test Conditions: $V_D = 32\text{ V}$, $I_{DQ} = 50\text{ mA}$, 100 us Pulse Width, 20% Duty Cycle.
2. 3dB Compression referenced at peak gain.
3. See "Pin Configuration and Description" for load pull and source pull reference planes.

2.4GHz, Load-pull

$Z_s(f_0) = 52.24 + 0.73i\Omega$
 $Z_s(2f_0) = 19.84 - 11.07i\Omega$
 $Z_s(3f_0) = 42.02 - 17.18i\Omega$
 $Z_l(2f_0) = 61.1 + 11.34i\Omega$
 $Z_l(3f_0) = 29.82 - 7.89i\Omega$

Max Power is 40.4dBm
at $Z = 18.166 + 11.298i\Omega$
 $\Gamma = -0.4278 + 0.2366i$
Max Gain is 14.4dB
at $Z = 15.289 + 22.193i\Omega$
 $\Gamma = -0.373 + 0.4667i$
Max PAE is 62.7%
at $Z = 13.992 + 28.16i\Omega$
 $\Gamma = -0.3092 + 0.5761i$

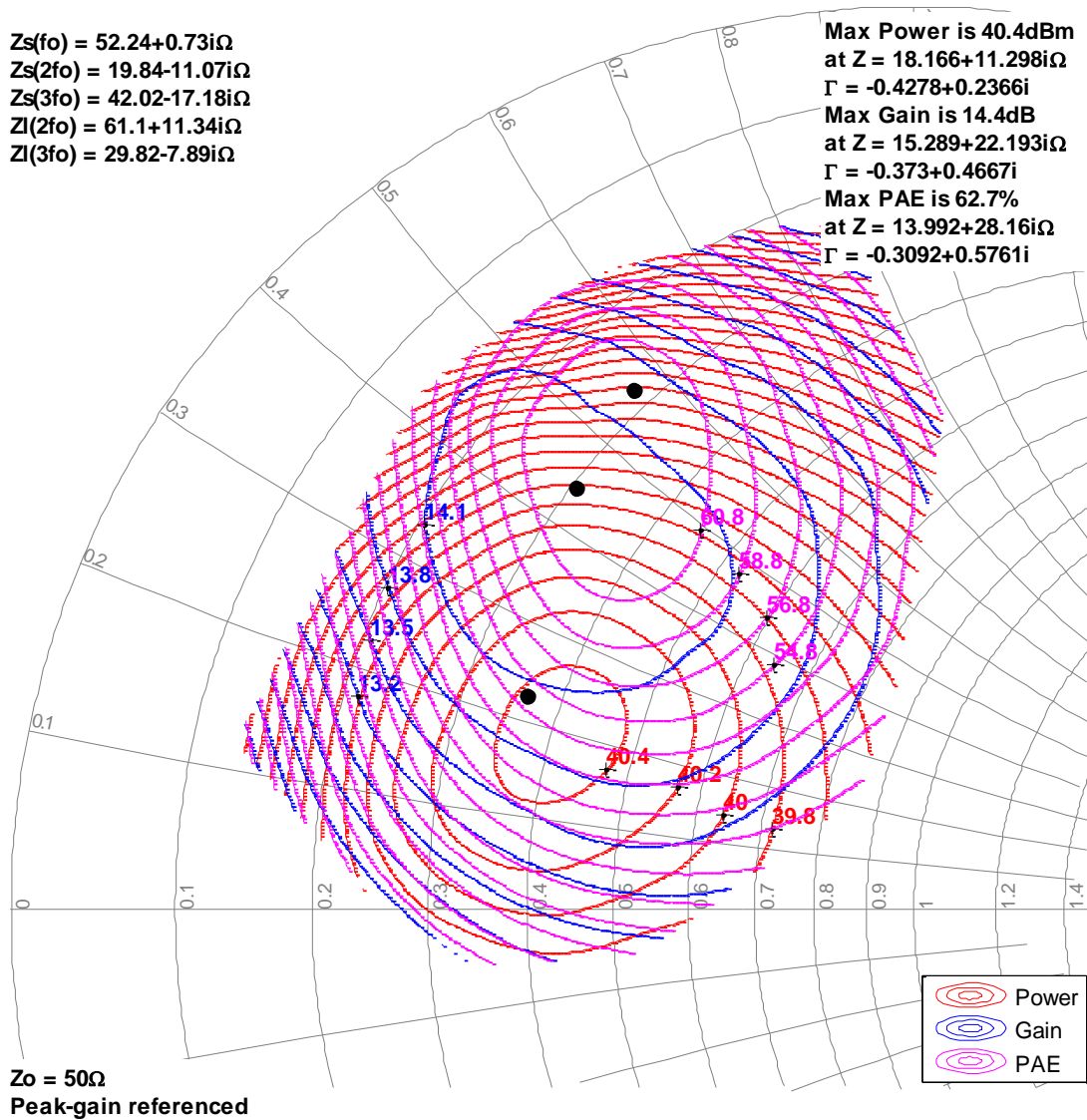

Load Pull Contours 1, 2, 3

Notes:

1. Test Conditions: $V_D = 32\text{ V}$, $I_{DQ} = 50\text{ mA}$, 100 us Pulse Width, 20% Duty Cycle.
2. 3dB Compression referenced at peak gain.
3. See "Pin Configuration and Description" for load pull and source pull reference planes.

2.7GHz, Load-pull

$Z_s(f_0) = 47.41 + 2.82i\Omega$
 $Z_s(2f_0) = 26.43 - 27.99i\Omega$
 $Z_s(3f_0) = 27.13 - 2.6i\Omega$
 $Z_l(2f_0) = 110.59 - 87.56i\Omega$
 $Z_l(3f_0) = 24.54 - 6.19i\Omega$

Max Power is 40.5dBm
at $Z = 18.277 + 11.064i\Omega$
 $\Gamma = -0.4271 + 0.2313i$
Max Gain is 13.6dB
at $Z = 13.801 + 16.01i\Omega$
 $\Gamma = -0.4745 + 0.37i$
Max PAE is 63.7%
at $Z = 12.205 + 20.142i\Omega$
 $\Gamma = -0.455 + 0.4711i$

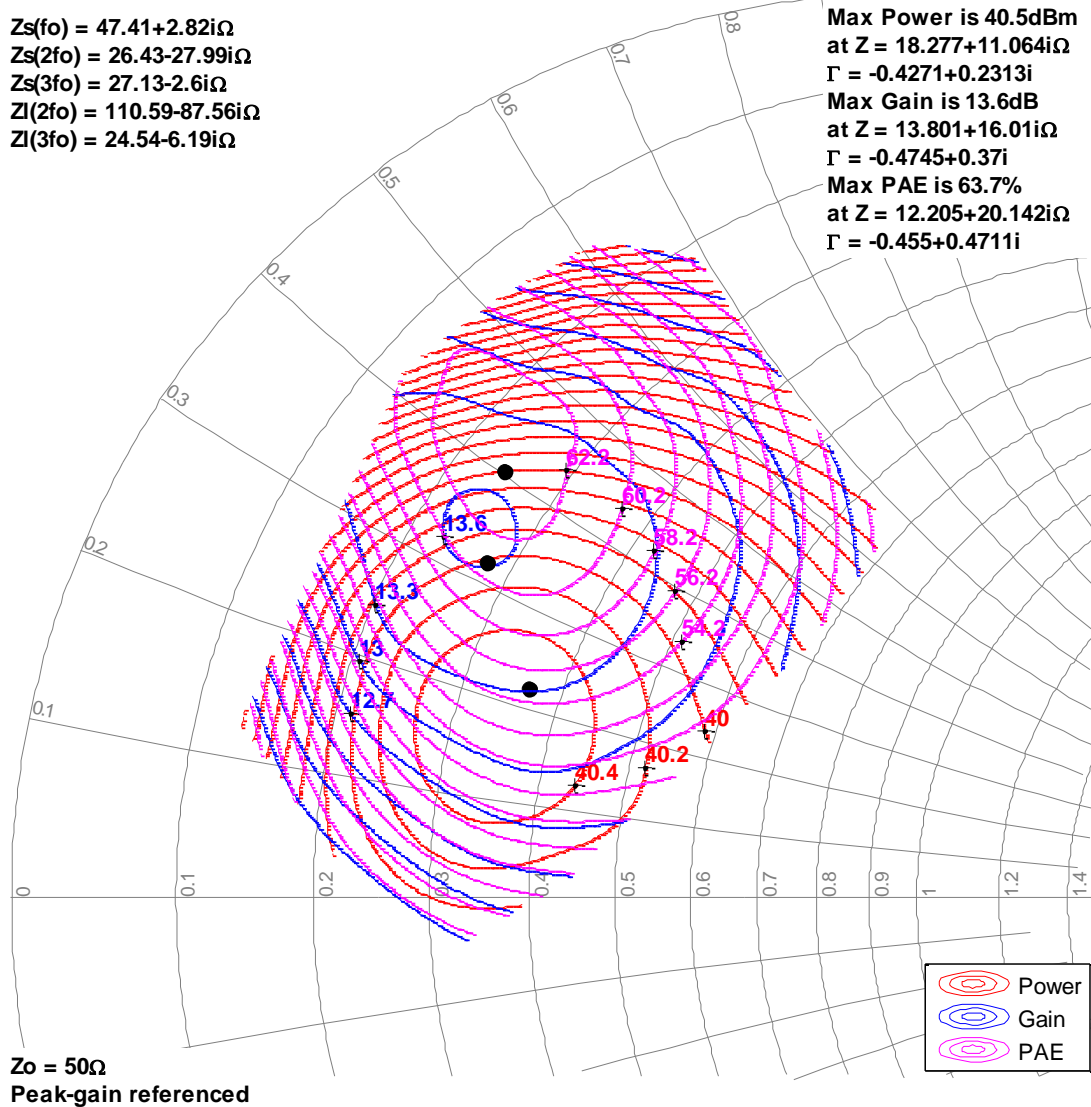

Load Pull Contours 1, 2, 3

Notes:

1. Test Conditions: $V_D = 32\text{ V}$, $I_{DQ} = 50\text{ mA}$, 100 us Pulse Width, 20% Duty Cycle.
2. 3dB Compression referenced at peak gain.
3. See "Pin Configuration and Description" for load pull and source pull reference planes.

3GHz, Load-pull

$Z_s(f_0) = 49.59 - 1.28i\Omega$
 $Z_s(2f_0) = 44 + 10.41i\Omega$
 $Z_s(3f_0) = 25.67 - 8.3i\Omega$
 $Z_l(2f_0) = 65.18 + 44.62i\Omega$
 $Z_l(3f_0) = 38.87 - 26.64i\Omega$

Max Power is 40.5dBm
at $Z = 18.327 + 11.73i\Omega$
 $\Gamma = -0.4216 + 0.2441i$
Max Gain is 12.4dB
at $Z = 12.252 + 20.075i\Omega$
 $\Gamma = -0.4551 + 0.4692i$
Max PAE is 58.6%
at $Z = 10.574 + 22.744i\Omega$
 $\Gamma = -0.4469 + 0.5433i$

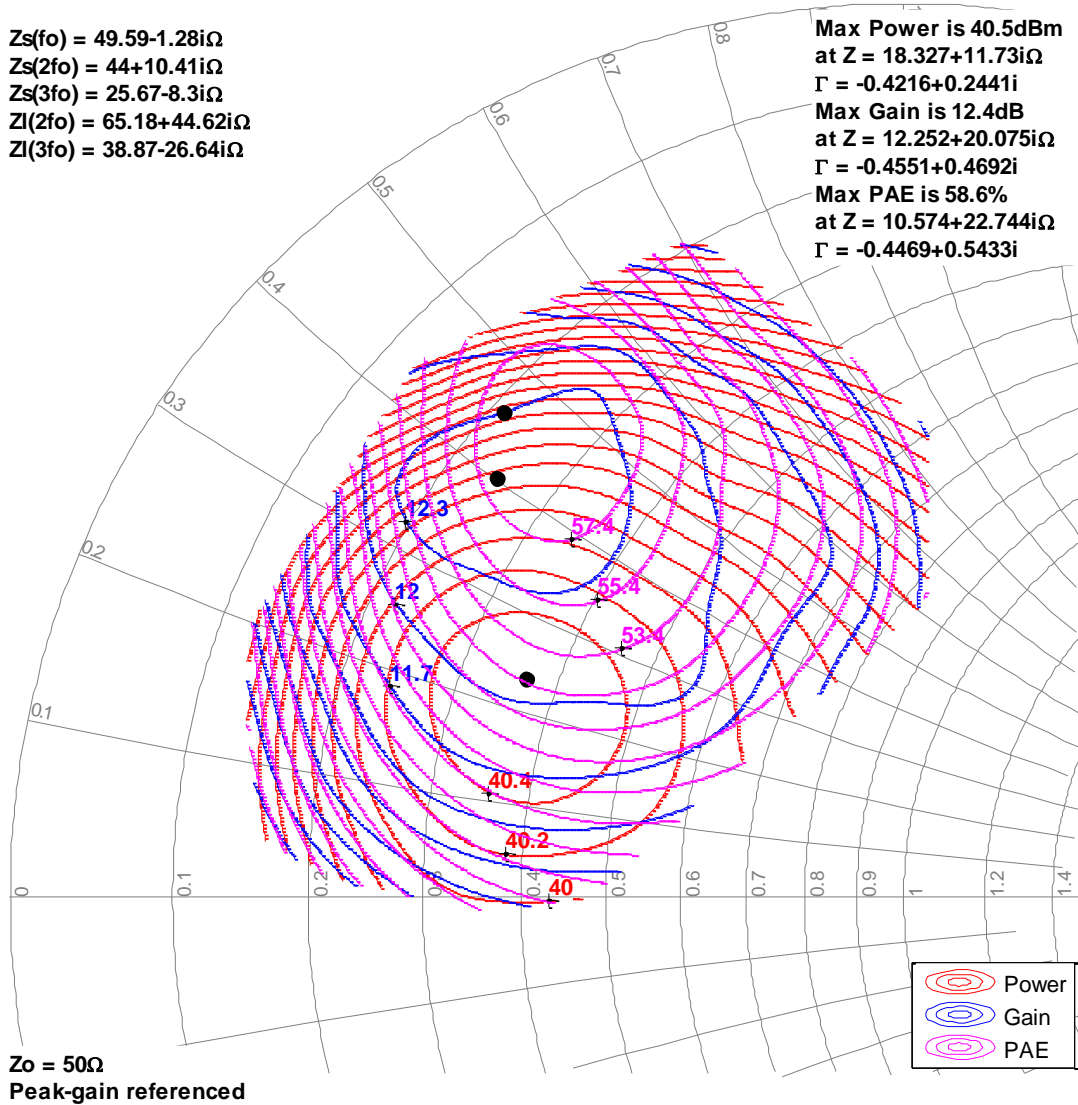

Typical Performance – Power Tuned ^{1, 2, 3}

Notes:

1. Test Conditions: $V_D = 32\text{ V}$, $I_{DQ} = 50\text{ mA}$, 100 us Pulse Width, 20% Duty Cycle.
2. The performance shown below is measured at device reference planes
3. See "Pin Configuration and Description" for load pull and source pull reference planes.

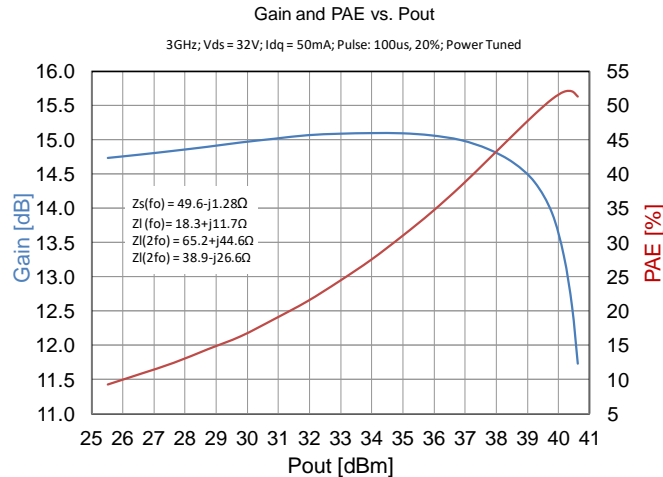
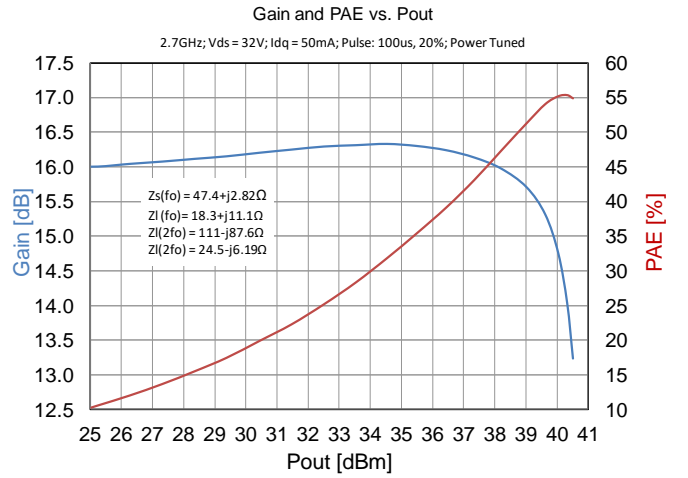
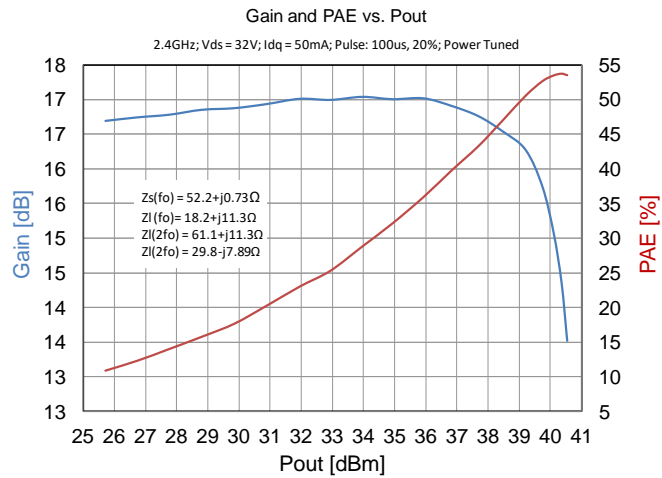
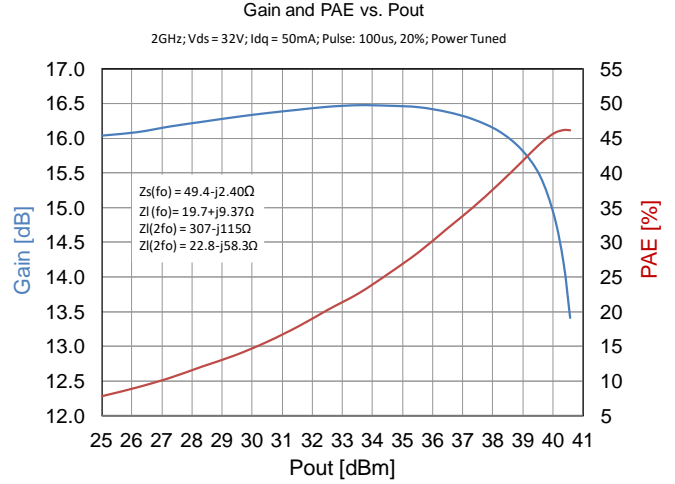
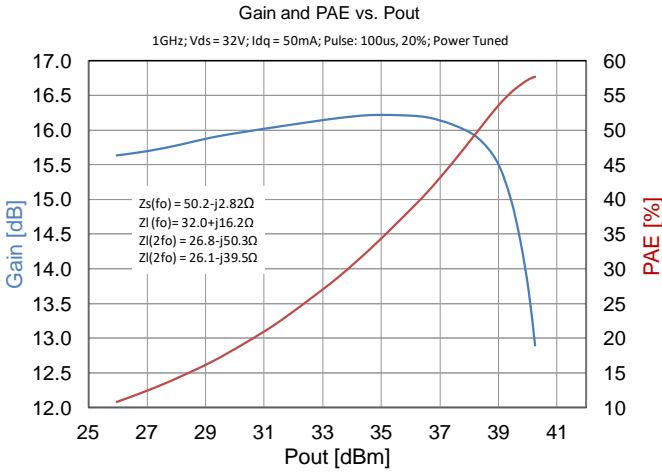

Typical Performance – Efficiency Tuned ^{1, 2, 3}

Notes:

1. Test Conditions: $V_D = 32\text{ V}$, $I_{DQ} = 50\text{ mA}$, 100 us Pulse Width, 20% Duty Cycle.
2. The performance shown below is measured at device reference planes
3. See "Pin Configuration and Description" for load pull and source pull reference planes.

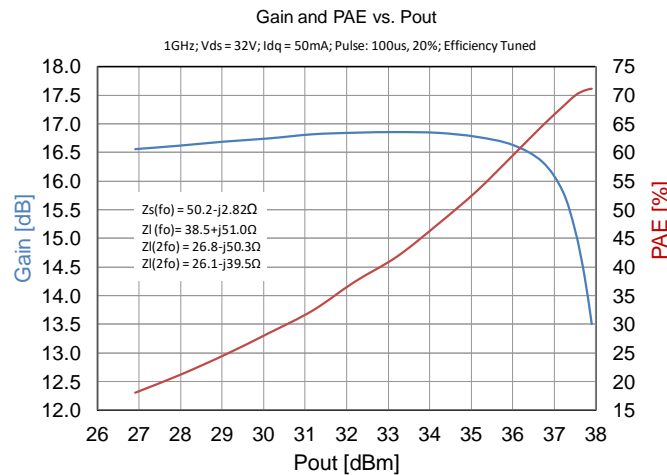
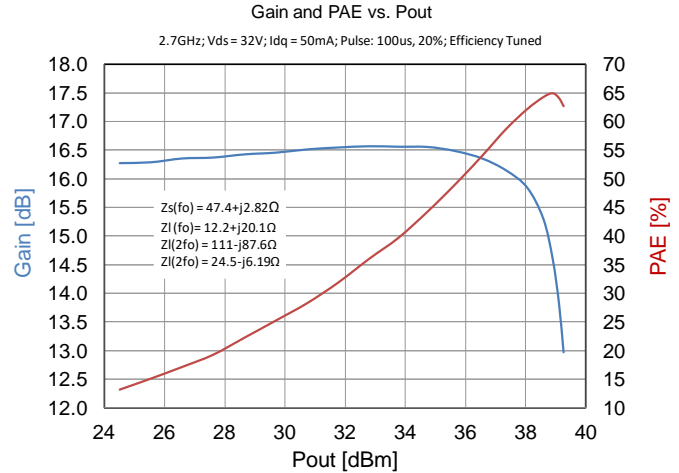
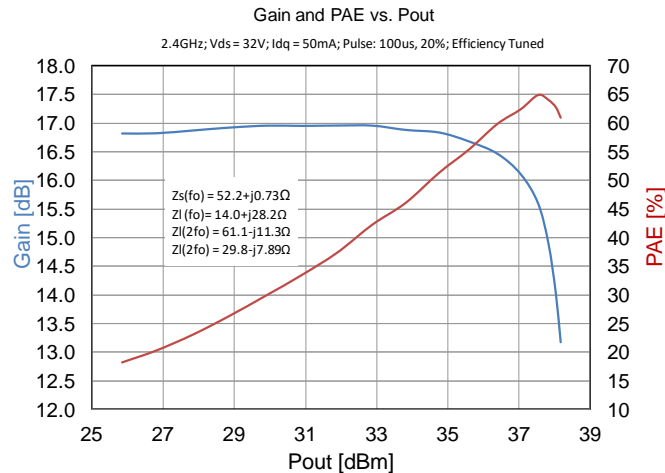
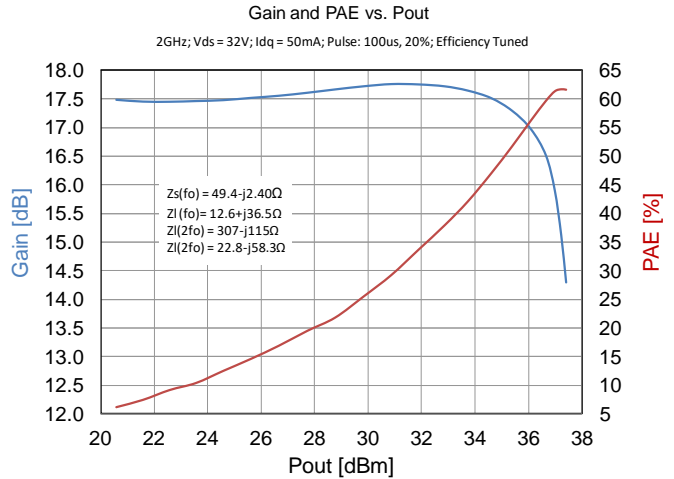
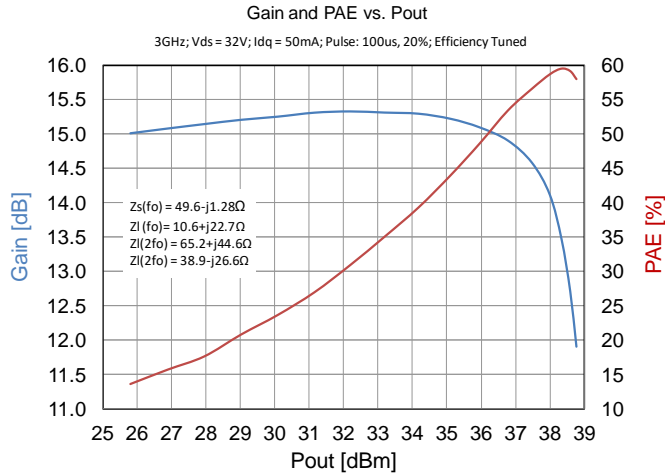

1.2 – 1.4 GHz Application Circuit - Schematic

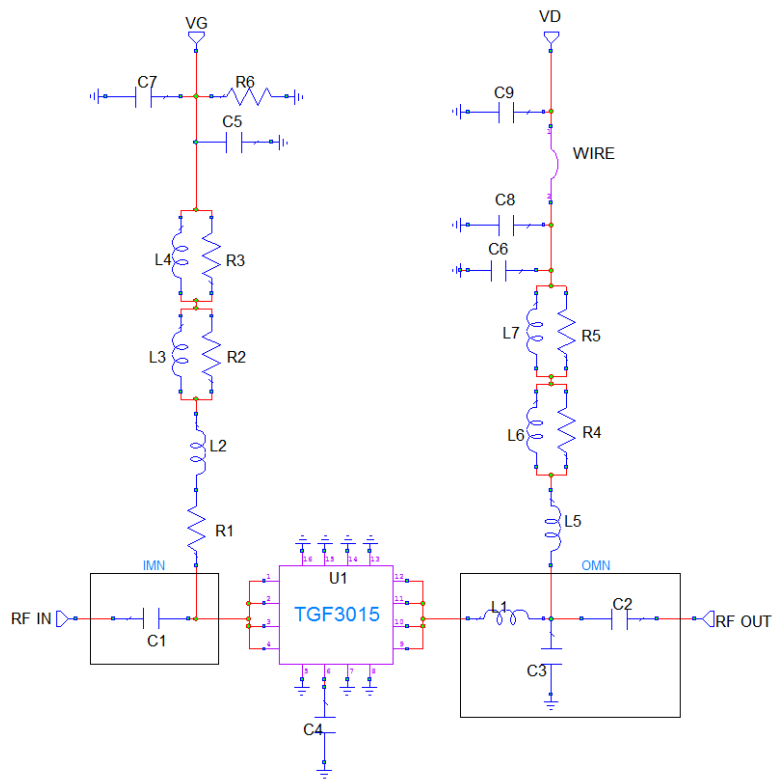

Bias-up Procedure	Bias-down Procedure
1. Set gate voltage (V_G) to -5.0V	1. Turn off RF signal
2. Set drain voltage (V_D) to 32 V	2. Turn off V_D and wait 1 second to allow drain capacitor dissipation
3. Slowly increase V_G until I_{DQ} is 50 mA.	3. Turn off V_G
4. Apply RF signal	

1.2 – 1.4 GHz Application Circuit EVB – Layout ^{1, 2}

Notes:

1. PCB material is RO4350B 0.020" thick, $\epsilon_r = 3.48$.
2. The PCB land pattern has been developed to accommodate lead and package tolerances.

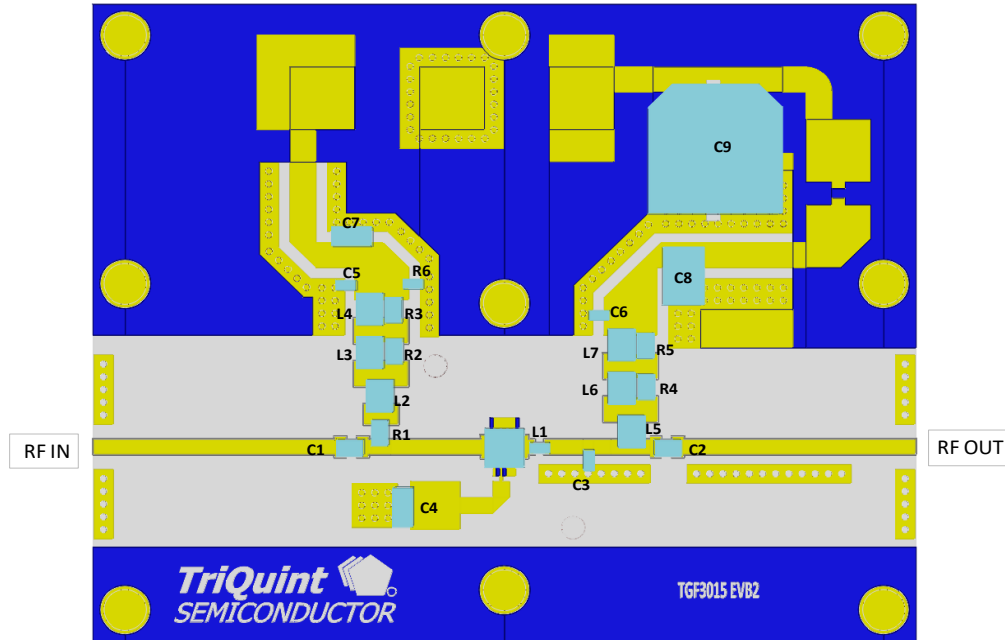

1.2 – 1.4 GHz Application Circuit – Bill of Material EVB1

Ref Des	Qty	Description	Mfg Name	Mfg Part #
R1	1	500 Ω		Generic 0603
R2, R3, R4, R5	4	400 Ω		Generic 0603
R6	1	1k Ω		Generic 0603
C1, C2, C5, C6	4	2400pF	Dielectric Labs	C08BL242X-5UN-X0T
C3	1	0.5pF	ATC	600S005BT250XT
C4, C7	2	10uF	TDK	C1632X5R0J106M130AC
C8	1	1uF	AVX	18121C105KAT2A
C9	1	220uF	United Chemicon	EMVY500ADA221MJA0G
L1	1	1.6nH	CoilCraft	0603HC-1N6XJLU
L2, L5	2	82nH	CoilCraft	1008CS-820XGLB
L3, L6	2	100nH	CoilCraft	1008CS-101XGLB
L4, L7	2	900nH	CoilCraft	1008AF-901XJLB

Evaluation Board Performance at 25°C ^{1, 2}

Notes:

1. Test Conditions: $V_D = 32\text{ V}$, $I_{DQ} = 50\text{ mA}$, 100 us Pulse Width, 20% Duty Cycle.
2. Performance measured on 0.5 GHz to 3.0 GHz Evaluation Board.

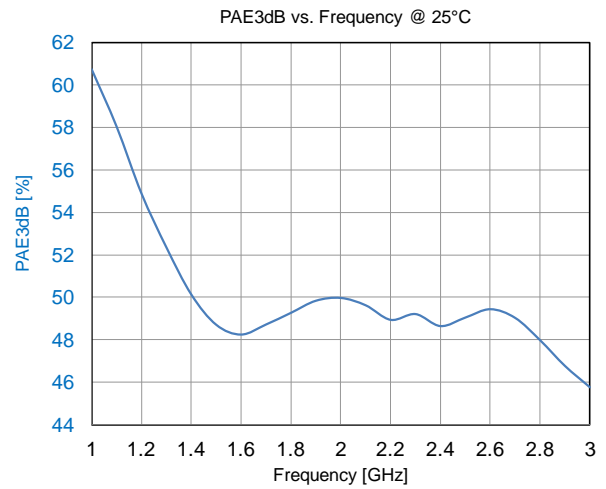
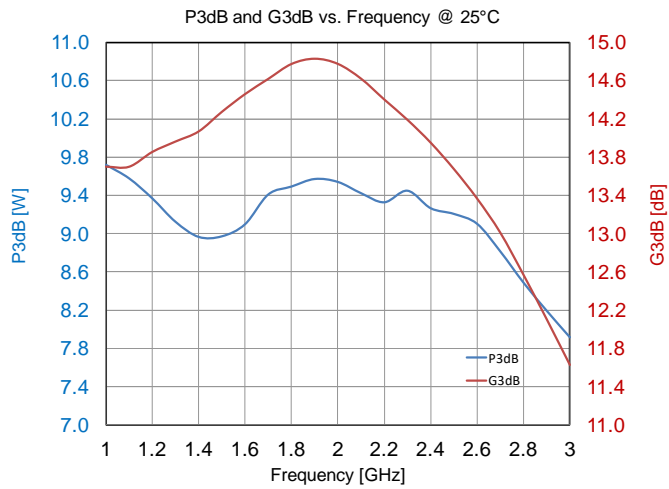

Evaluation Board Performance Over Temperature ^{1,2}

Notes:

1. Test Conditions: $V_D = 32\text{ V}$, $I_{DQ} = 50\text{ mA}$, 100 us Pulse Width, 20% Duty Cycle.
2. Performance measured on 0.5 GHz to 3.0 GHz Evaluation Board.

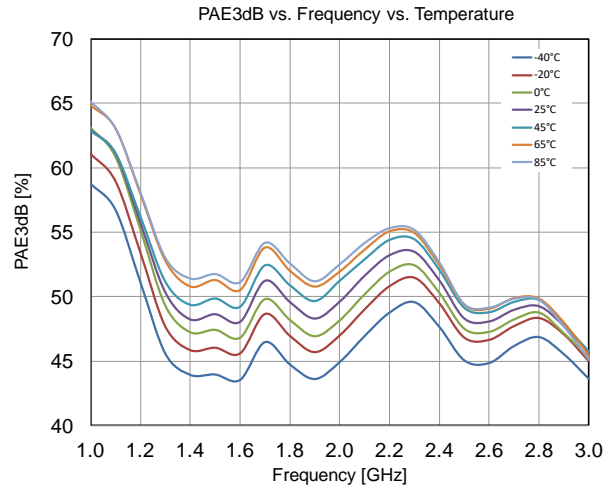
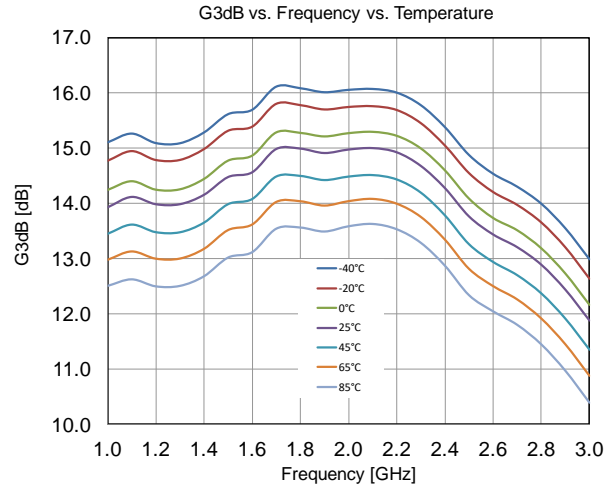
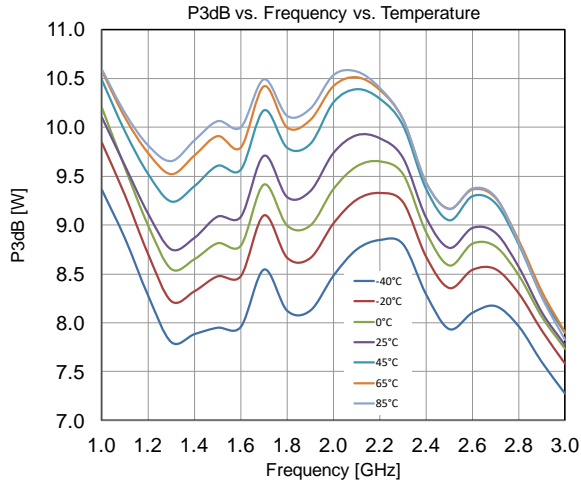

Pin Configuration and Description ^{1,2}

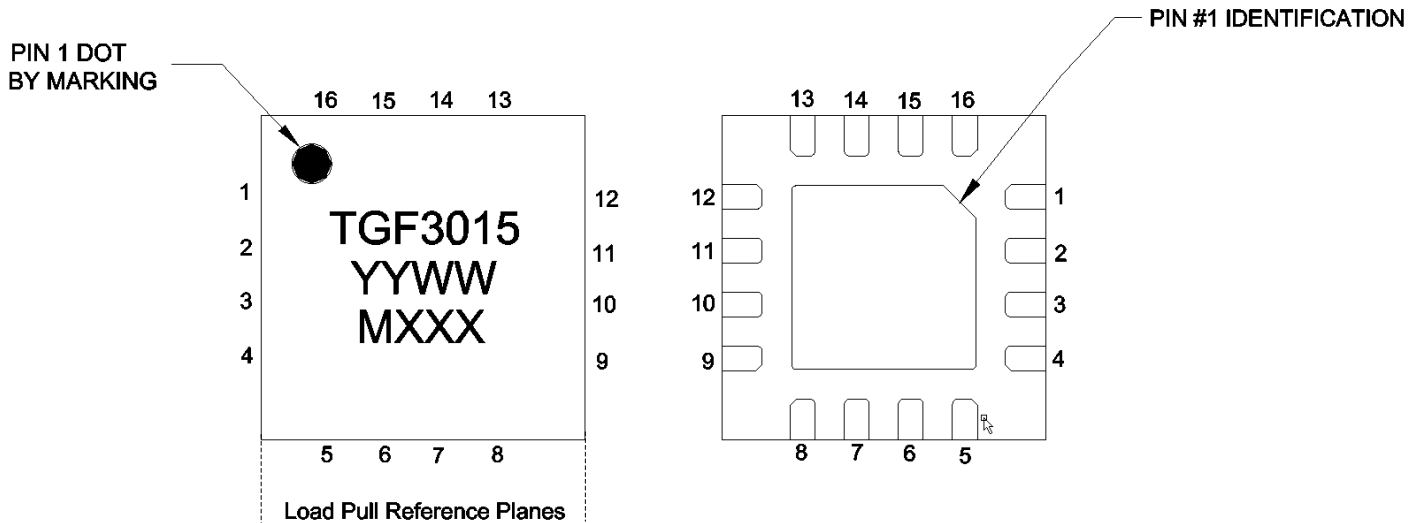

Notes:

1. Thermal resistance measured to back side of package
2. The TGF3015-SM will be marked with the "TGF3015" designator and a lot code marked below the part designator. The "YY" represents the last two digits of the calendar year the part was manufactured, the "WW" is the work week of the assembly lot start, and the "MXXX" is the production lot number.

Pin	Symbol	Description
9, 10, 11, 12	V_D / RF OUT	Drain voltage / RF Output to be matched to 50 ohms.
3	V_G / RF IN	Gate voltage / RF Input to be matched to 50 ohms.
6	Off-Chip Cap	Off-chip cap to extend low frequency gain.
Back side	Source	Source connected to ground

Mechanical Drawing ¹⁻⁴

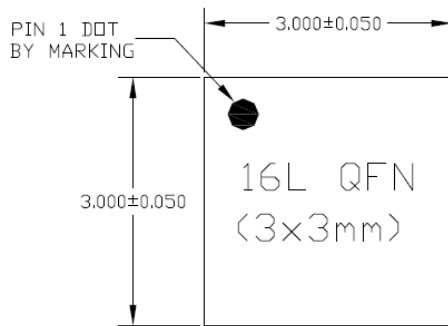

TOP VIEW

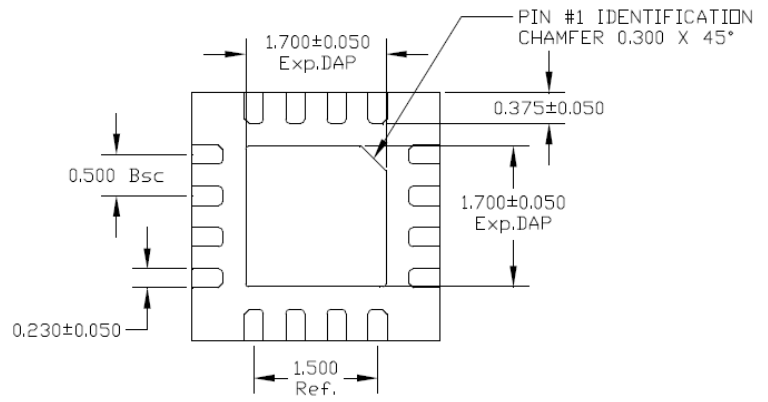

BOTTOM VIEW

A	QFN	
	MAX.	0.900
NOM.	0.850	
MIN.	0.800	

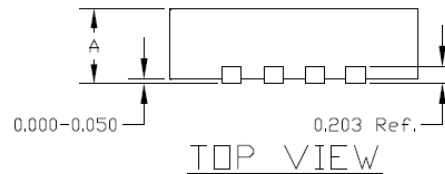

TOP VIEW

Notes:

1. Dimension tolerance is ± 0.127 mm, unless noted otherwise.
2. This package is lead-free/RoHS-compliant.
3. The plating material on the leads is NiPdAu.
4. It is compatible with both lead-free (maximum 260 °C reflow temperature) and tin-lead (maximum 245°C reflow temperature) soldering processes

Recommended Solder Temperature Profile

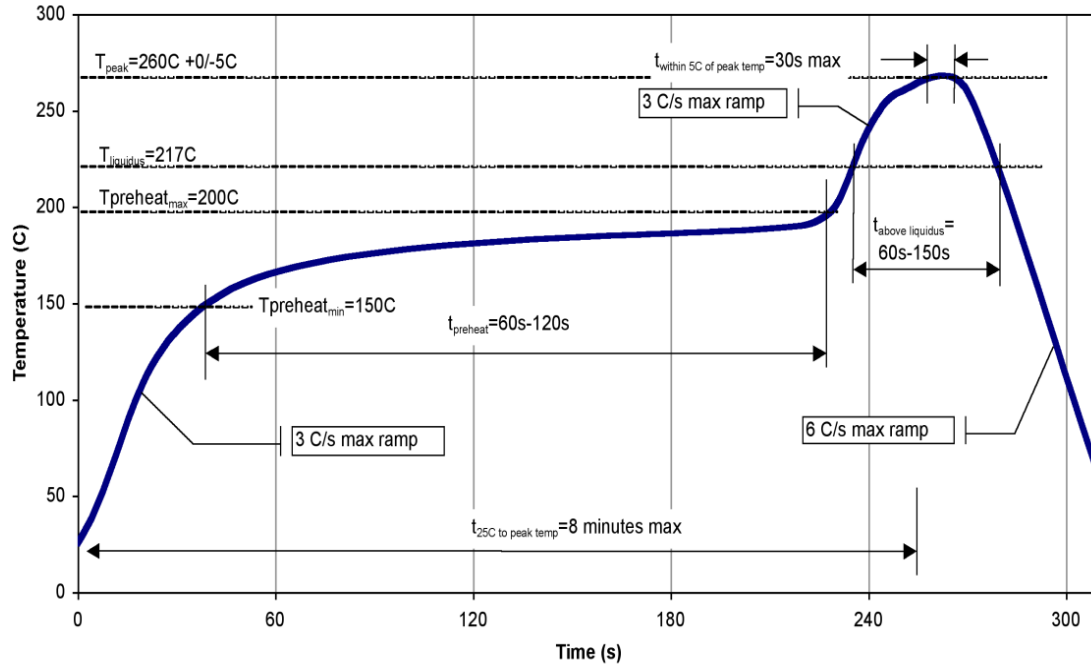

Handling Precautions

Parameter	Rating	Standard
ESD – Human Body Model (HBM)	Class 1B	JEDEC JS-001
ESD – Charged Device Model (CDM)	Class C2B	JEDEC JS-002
MSL – Moisture Sensitivity Level	MSL3	JESD J-STD-020



Caution!
ESD-Sensitive Device

Solderability

Compatible with both lead-free (260°C max. reflow temp.) and tin/lead (245°C max. reflow temp.) soldering processes. Solder profiles available upon request. The use of no-clean solder to avoid washing after soldering is recommended. Contact plating: NiPdAu. Minimum Au thickness is 100micro-inches

RoHS Compliance

This part is compliant with 2011/65/EU RoHS directive (Restrictions on the Use of Certain Hazardous Substances in Electrical and Electronic Equipment) as amended by Directive 2015/863/EU.

This product also has the following attributes:

- Halogen Free (Chlorine, Bromine)
- Antimony Free
- TBBP-A (C₁₅H₁₂Br₄O₂) Free
- PFOS Free
- SVHC Free
- Lead Free

Contact Information

For the latest specifications, additional product information, worldwide sales and distribution locations:

Web: www.qorvo.com

Tel: 1-844-890-8163

Email: customer.support@qorvo.com

Important Notice

The information contained herein is believed to be reliable; however, Qorvo makes no warranties regarding the information contained herein and assumes no responsibility or liability whatsoever for the use of the information contained herein. All information contained herein is subject to change without notice. Customers should obtain and verify the latest relevant information before placing orders for Qorvo products. The information contained herein or any use of such information does not grant, explicitly or implicitly, to any party any patent rights, licenses, or any other intellectual property rights, whether with regard to such information itself or anything described by such information. **THIS INFORMATION DOES NOT CONSTITUTE A WARRANTY WITH RESPECT TO THE PRODUCTS DESCRIBED HEREIN, AND QORVO HEREBY DISCLAIMS ANY AND ALL WARRANTIES WITH RESPECT TO SUCH PRODUCTS WHETHER EXPRESS OR IMPLIED BY LAW, COURSE OF DEALING, COURSE OF PERFORMANCE, USAGE OF TRADE OR OTHERWISE, INCLUDING THE IMPLIED WARRANTIES OF MERCHANTABILITY AND FITNESS FOR A PARTICULAR PURPOSE.**

Without limiting the generality of the foregoing, Qorvo products are not warranted or authorized for use as critical components in medical, life-saving, or life-sustaining applications, or other applications where a failure would reasonably be expected to cause severe personal injury or death.

Copyright 2020 © Qorvo, Inc. | Qorvo is a registered trademark of Qorvo, Inc.

X-ON Electronics

Largest Supplier of Electrical and Electronic Components

Click to view similar products for [RF JFET Transistors](#) category:

Click to view products by [Qorvo](#) manufacturer:

Other Similar products are found below :

[CE3514M4](#) [CE3514M4-C2](#) [CE3520K3-C1](#) [CE3521M4](#) [CE3521M4-C2](#) [CE3512K2-C1](#) [CE3520K3](#) [CG2H80030D-GP4](#) [TGF2023-2-02](#)
[NPT1004D](#) [MAGX-011086](#) [NPT25015D](#) [JANTXV2N4858](#) [MMBFJ211](#) [NPT2021](#) [NPTB00025B](#) [2SK3557-6-TB-E](#) [J211_D74Z](#)
[NPTB00004A](#) [QPD0020](#) [QPD1006](#) [QPD1016](#) [QPD1025L](#) [QPD1029L](#) [QPD1881L](#) [T2G6001528-Q3](#) [SKY65050-372LF](#) [TGF2965-SM](#)
[QPD1009](#) [QPD1010](#) [J304](#) [CGH27015F](#) [CGH55015F1](#) [CMPA801B030F](#) [GTVA262711FA-V2-R0](#) [GTVA262701FA-V2-R0](#) [CGH40006S](#)
[CGH40010F](#) [CGH40025F](#) [CGH40035F](#) [CGH40045F](#) [CGH40120F](#) [CGH55015F2](#) [CGH60008D](#) [CGH60030D](#) [CGHV14500F](#) [CGHV1F006S](#)
[CGHV1J006D](#) [CGHV27030S](#) [CGHV27060MP](#)