

Product Overview

The Qorvo TGL2206-SM is a high power, wideband GaAs VPIN limiter capable of protecting sensitive receive channel components against high power incident signals. The TGL2206-SM does not require DC bias and achieves a low insertion loss all in a small form factor. These features allow for simple integration with minimal impact to system performance.

The TGL2206-SM operates from 2.0 to 5.5 GHz with low insertion loss of less than 1.0 dB. It can limit up to 100 W incident pulsed power with a low flat leakage of less than 15.5 dBm.

The TGL2206-SM is offered in a 5x5 mm air-cavity QFN packaged limiter comprised of an aluminum-nitride base with a plastic epoxy-sealed lid. It is well suited for both commercial and defense related applications.

Lead-free and RoHS compliant.

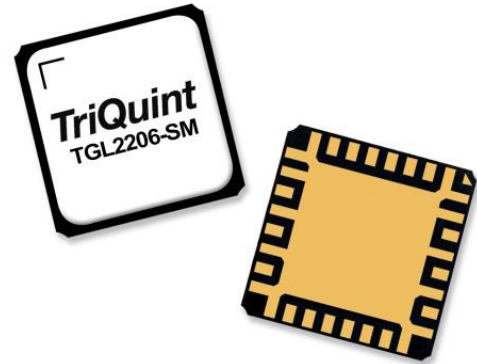

5 mm x 5 mm Air Cavity QFN Package

Functional Block Diagram

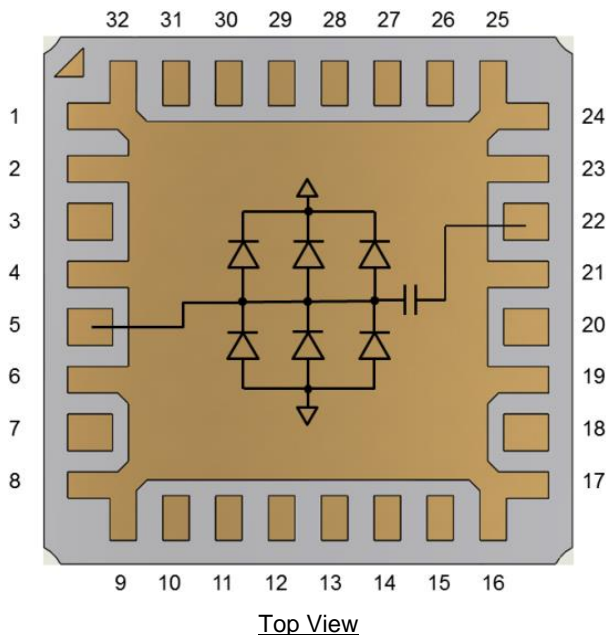

Key Features

- Frequency Range: 2.0 to 5.5 GHz
- Insertion Loss: < 1.0 dB
- Peak Power Handling: 100 W (pulsed)
- Flat Leakage: < 15.5 dBm
- Passive (no DC bias required)
- Integrated DC Block on Output
- Spike Leakage < 16 dBm
- Recovery Time < 115 ns
- Package Dimensions: 5.0 x 5.0 x 1.45 mm

Performance is typical across frequency. Please reference electrical specification table and data plots for more details.

Applications

- Receive Chain Protection
- Commercial and Military Radar

Ordering Information

Part	Description
TGL2206-SM	2.0 to 5.5 GHz 100W VPIN Limiter
TGL2206-SMEVB-01	2.0 to 5.5 GHz 100W VPIN Limiter EVB

Absolute Maximum Ratings

Parameter	Rating
Incident Power, CW or Pulsed, 50 Ω, 25 °C	100 W
Incident Power, CW or Pulsed, 50 Ω, 85 °C	70 W
Mounting Temperature (30 seconds max)	260 °C
Storage Temperature	-40 to 150 °C

Exceeding any one or a combination of the Absolute Maximum Rating conditions may cause permanent damage to the device. Extended application of Absolute Maximum Rating conditions to the device may reduce device reliability.

Recommended Operating Conditions

Parameter	Min	Typ.	Max	Units
Passive – No Bias				
Operating Temperature Range	-40	+25	+85	°C

Electrical specifications are measured at specified test conditions. Specifications are not guaranteed over all recommended operating conditions.

Electrical Specifications

Parameter	Min	Typical	Max	Units
Operational Frequency Range	2		5.5	GHz
Insertion Loss		< 1.0		dB
Input Return Loss		15		dB
Output Return Loss		15		dB
Flat Leakage Power at P _{IN} > 30 dBm		< 15		dBm
Pulse Recovery Time		< 115		ns
Spike Leakage		< 16		dBm
Insertion Loss Temperature Coefficient		0.003		dB / °C

Notes: Test conditions unless otherwise noted: Temp = +25 °C, Tuned EVB Results.

Thermal and Reliability Information

Parameter	Test Conditions	Value	Units
Incident Power (168 Hours RF Operational Life Test ⁽¹⁾)	Frequency = 4.5 GHz RF CW, 50 Ω, 25 °C	50	W
	Frequency = 4.5 GHz RF Pulsed, PW=10 μs, DC=10%, 50 Ω, 25 °C	100	W

Notes: (1) Test terminated after 168 hours. Insertion Loss remained ≤ 1 dB for device under test.

Performance Plots – Small Signal

Test conditions unless otherwise noted: Temp.=+25 °C, Tuned EVB Performance

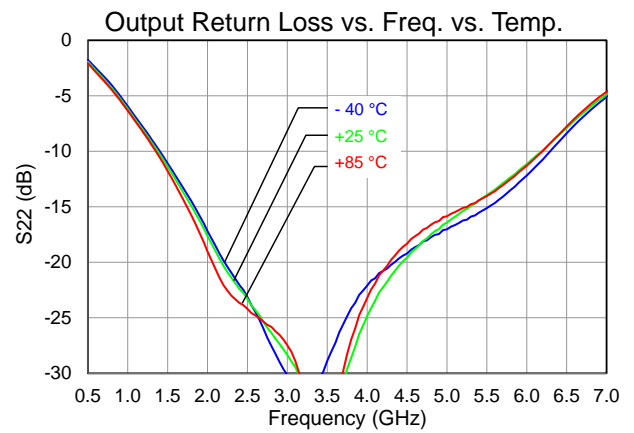
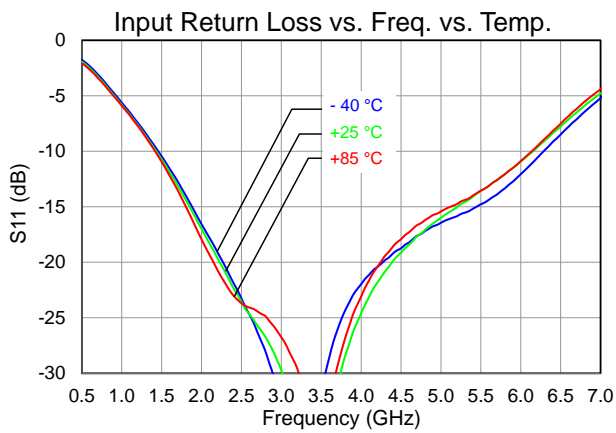
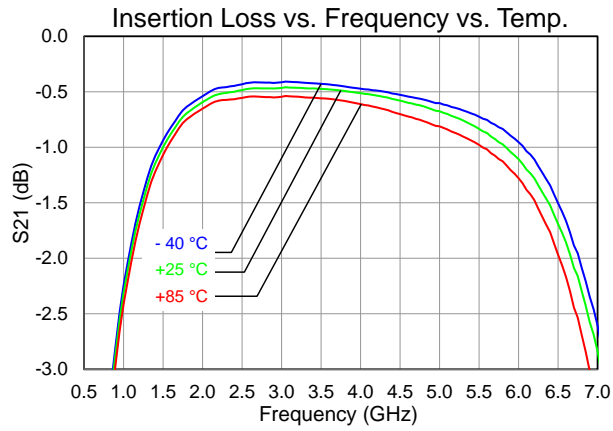

Performance Plots –Large Signal

Test conditions unless otherwise noted: CW input power, Temp.=+25 °C, Tuned EVB Performance

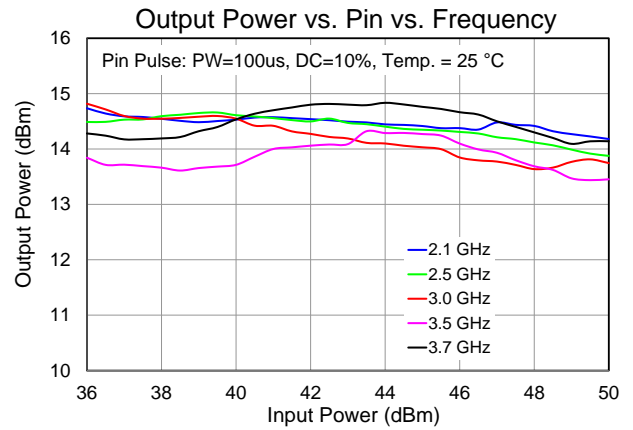
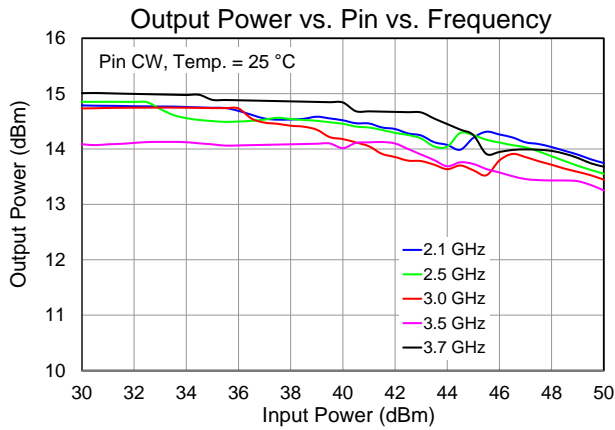
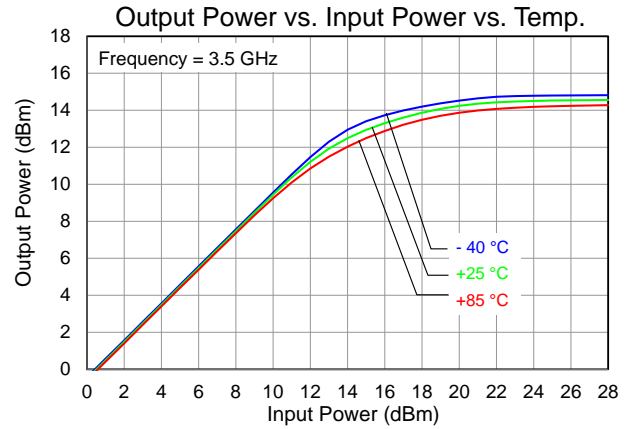
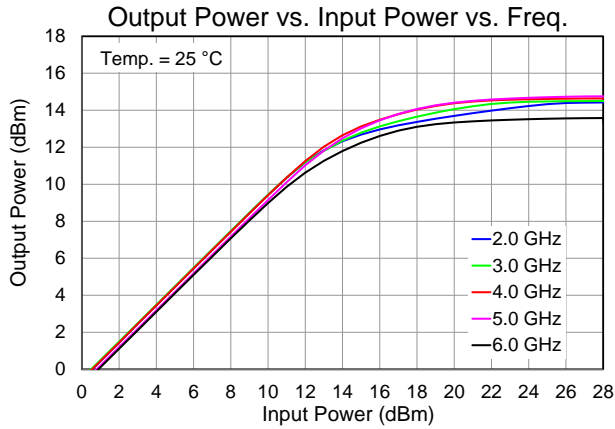

Mechanical Drawing and Pad Configuration

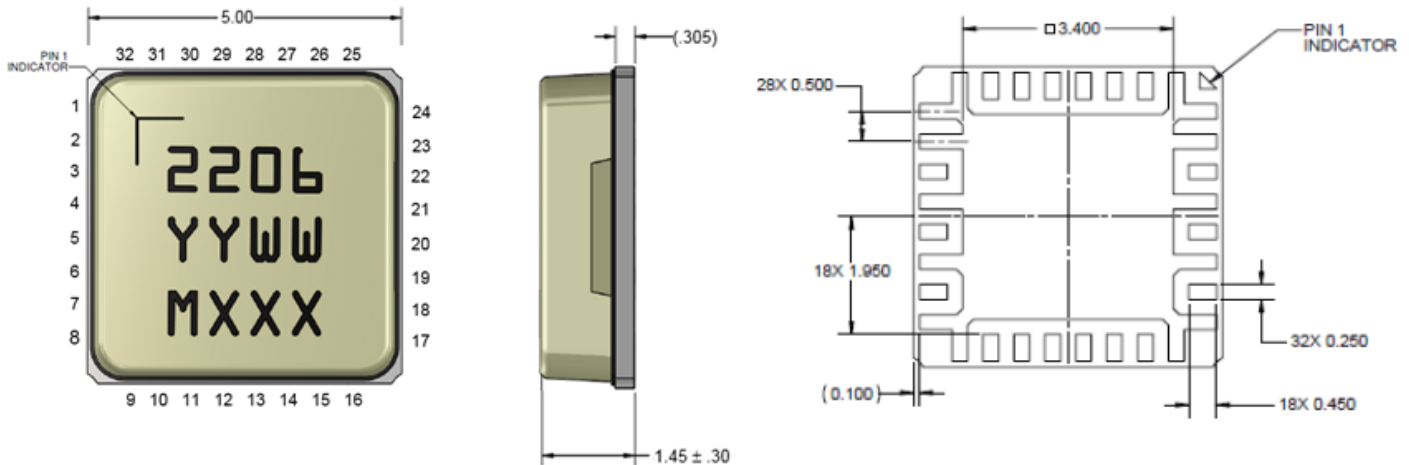

The TGL2206-SM will be marked with the “YYMM” designator and a lot code marked below the part designator. The “YY” represents the last two digits of the year the part was manufactured, the “WW” is the work week, and the “MXXX” is the batch ID.

The package base is ceramic and the plating material on the leads is gold over nickel (Au-Ni), the lid is plastic, the part is epoxy sealed.

Dimensions Units: mm. Tolerance unless specified: .xx = +/- 0.25, .xxx = +/- 0.127

Pad No.	Label	Description
1,2,4,6,8,9,16,17,19,21,23, 24, 25, 32	GND	On PCB, multiple copper-filled vias should be employed under the center pad to minimize inductance and thermal resistance. See page 6 for suggested mounting configuration
5	RF Input	RF Input, matched to 50 Ohms, not DC blocked
22	RF Output	RF Output, matched to 50 Ohms, DC blocked
3,7,10-15,18,20, 26-31	NC	No connection, may be grounded if desired

NOTE: The RF Input and RF Output ports are not interchangeable.

Assembly Notes

- Compatible with lead-free soldering process with 260°C peak reflow temperature.
- This package is non-hermetic, and therefore cannot be subjected to aqueous washing. The use of no-clean solder to avoid washing after soldering is recommended
- Solder rework not recommended.
- Contact plating: Ni-Au

Recommended Soldering Profile

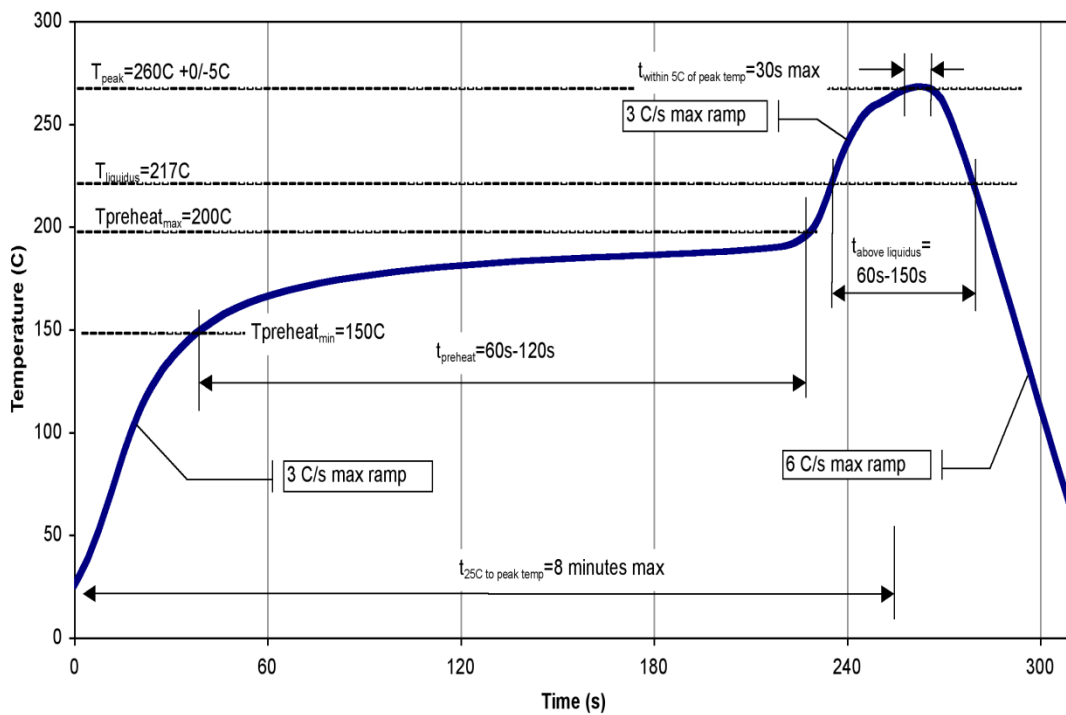

Handling Precautions

Parameter	Rating	Standard
ESD – Human Body Model (HBM)	Class 1B	ESDA / JEDEC JS-001-2012
ESD – Charged Device Model (CDM)	Class C3	JEDEC JESD22-C101
MSL – Moisture Sensitivity Level	Level 3	IPC/JEDEC J-STD-020



Caution!
ESD-Sensitive Device

RoHS Compliance

This part is compliant with 2011/65/EU RoHS directive (Restrictions on the Use of Certain Hazardous Substances in Electrical and Electronic Equipment) as amended by Directive 2015/863/EU.

This product also has the following attributes:

- Lead Free
- Halogen Free (Chlorine, Bromine)
- Antimony Free
- TBBP-A (C₁₅H₁₂Br₄O₂) Free
- PFOS Free
- SVHC Free



Contact Information

For the latest specifications, additional product information, worldwide sales and distribution locations:

Web: www.qorvo.com

Tel: 1-844-890-8163

Email: customer.support@qorvo.com

Important Notice

The information contained herein is believed to be reliable; however, Qorvo makes no warranties regarding the information contained herein and assumes no responsibility or liability whatsoever for the use of the information contained herein. All information contained herein is subject to change without notice. Customers should obtain and verify the latest relevant information before placing orders for Qorvo products. The information contained herein or any use of such information does not grant, explicitly or implicitly, to any party any patent rights, licenses, or any other intellectual property rights, whether with regard to such information itself or anything described by such information. **THIS INFORMATION DOES NOT CONSTITUTE A WARRANTY WITH RESPECT TO THE PRODUCTS DESCRIBED HEREIN, AND QORVO HEREBY DISCLAIMS ANY AND ALL WARRANTIES WITH RESPECT TO SUCH PRODUCTS WHETHER EXPRESS OR IMPLIED BY LAW, COURSE OF DEALING, COURSE OF PERFORMANCE, USAGE OF TRADE OR OTHERWISE, INCLUDING THE IMPLIED WARRANTIES OF MERCHANTABILITY AND FITNESS FOR A PARTICULAR PURPOSE.**

Without limiting the generality of the foregoing, Qorvo products are not warranted or authorized for use as critical components in medical, life-saving, or life-sustaining applications, or other applications where a failure would reasonably be expected to cause severe personal injury or death.

Copyright 2020 © Qorvo, Inc. | Qorvo is a registered trademark of Qorvo, Inc.

X-ON Electronics

Largest Supplier of Electrical and Electronic Components

Click to view similar products for [Signal Conditioning](#) category:

Click to view products by [Qorvo](#) manufacturer:

Other Similar products are found below :

[MAPDCC0001](#) [MAPDCC0004](#) [PD0409J5050S2HF](#) [880157](#) [HHS-109-PIN](#) [DC1417J5005AHF](#) [AFS14A30-2185.00-T3](#) [AFS14A35-1591.50-T3](#) [DS-323-PIN](#) [B39321R801H210](#) [1A0220-3](#) [JP510S](#) [LFB212G45SG8C341](#) [LFB322G45SN1A504](#) [LFL182G45TC3B746](#) [SF2159E](#) [30057](#) [FM-104-PIN](#) [CER0813B](#) [MAPDCC0005](#) [3A325](#) [40287](#) [41180](#) [ATB3225-75032NCT](#) [BD0810N50100AHF](#) [BD2425J50200AHF](#) [C5060J5003AHF](#) [JHS-115-PIN](#) [JP503AS](#) [DC0710J5005AHF](#) [DC2327J5005AHF](#) [DC3338J5005AHF](#) [43020](#) [LFB2H2G60BB1C106](#) [LFL15869MTC1B787](#) [X3C19F1-20S](#) [XC3500P-20S](#) [10013-20](#) [SF2194E](#) [CDBLB455KCAX39-B0](#) [TGL2208-SM, EVAL](#) [RF1353C](#) [1E1305-3](#) [1F1304-3S](#) [1G1304-30](#) [B0922J7575AHF](#) [2020-6622-20](#) [10017-3](#) [TP-103-PIN](#) [BD1222J50200AHF](#)