

Product Description

Qorvo’s TGL2223 is a wideband, 5-bit digital attenuator using Qorvo’s TQPHT15 production 0.15um GaAs pHEMT process. Operating from 0.1 - 31 GHz, the TGL2223 offers a low LSB of 0.5 dB and supports > 15.5 dB of attenuation range with a low RMS step error of < 0.5 dB.

Using standard, negative control voltages from -3.3 to -5 V coupled with excellent broadband performance, the TGA2223 is ideal component to support a wide variety of commercial and military applications.

The TGL2223 is in die form, with a compact size of 1.180 x 0.800 x 0.100 mm. Both RF ports are matched to 50 ohms for easy system integration.

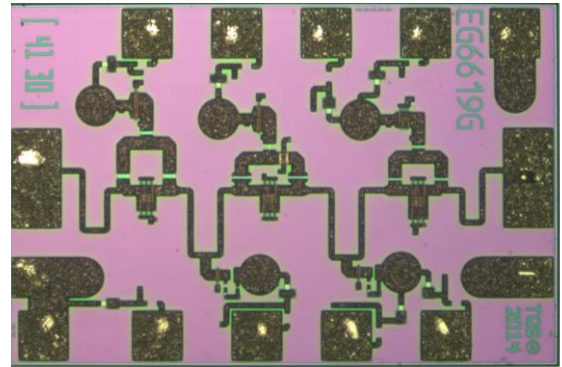

Product Features

- Frequency Range: 0.1-31 GHz
- 5-Bit Digital Attenuator
- Attenuation Step Size (LSB): 0.5 dB
- Attenuation Range: 15.5 dB
- Insertion Loss (Ref. State): 1.8-4.2 dB
- RMS Attenuation Error: < 0.9 dB
- RMS Step Error: < 0.4 dB
- Control Voltage: -3.3 to -5.0 V
- Die Size: 1.180 x 0.800 x 0.100 mm

Performance is typical across frequency. Please reference electrical specification table and data plots for more details.

Applications

- Commercial and Military Radar
- Electronic Warfare
- Satellite Communications
- Point to Point Radio
- General Purpose

Block Diagram

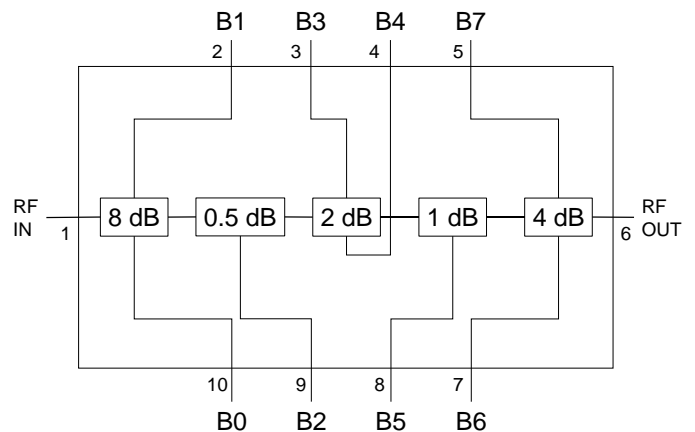

Ordering Information

Part No.	Description
TGL2223	0.1–31 GHz 5-Bit Digital Attenuator
1122552	TGL2223 Evaluation Board

Electrical Specifications

Test conditions, unless otherwise noted: 25 °C, $V_C = 0 / -5.0$ V. Data de-embedded to reference plane, data included bond wire effects

Parameter	Min	Typ	Max	Units
Frequency Range	0.1		31	GHz
LSB Attenuation		0.5		dB
Attenuation range		15.5		dB
Reference State Insertion Loss: 1-6 GHz		< 1.9		dB
Reference State Insertion Loss: 6-18 GHz		< 2.7		dB
Reference State Insertion Loss: 18-31 GHz		< 4.2		dB
Input Return Loss		> 12		dB
Output Return Loss		> 9		dB
IIP3 ($\Delta f = 1.0$ MHz, $P_{IN}/Tone = 5$ dBm, 14 GHz, all states)		> 26		dBm
Switching Speed (10%-90%, 90%-10%)		< 30		ns
RMS Attenuation Error		< 0.9		dB
RMS Step Error		< 0.4		dB
Max. Attenuation Error		< 2.4		dB

Recommended Operating Conditions

Parameter	Value / Range	Units
Control Voltage (Logic L = 0)	-3.3 to -5	V
Control Voltage (Logic H = 1)	0	V
Operating Temperature Range	-40 to +85	°C

Electrical specifications are measured at specified test conditions. Specifications are not guaranteed over all recommended operating conditions.

Absolute Maximum Ratings

Parameter	Value / Range	Units
Control Voltage (V_C)	-6	V
Control Current (I_C)	1	mA
Input Power, (P_{IN})	30	dBm
Power Dissipation (P_{DISS})	0.7	W
Operating Channel Temperature (T_{CH})	150	°C

Exceeding any one or a combination of the Absolute Maximum Rating conditions may cause permanent damage to the device. Extended application of Absolute Maximum Rating conditions to the device may reduce device reliability.

Performance Plots – Small Signal

Test conditions unless otherwise noted: Tested with DUT on EVB

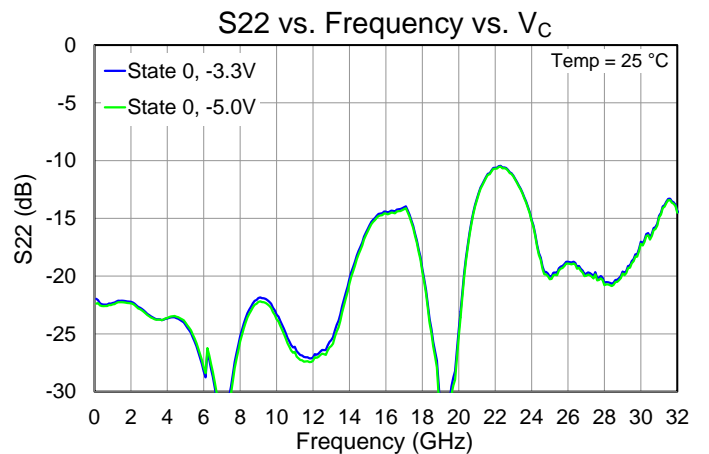
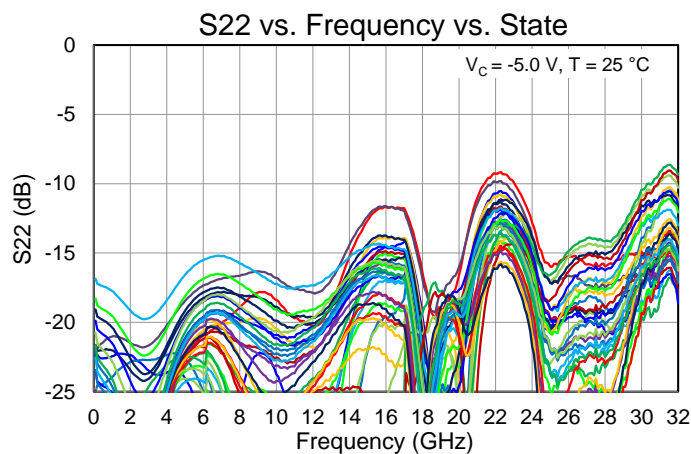
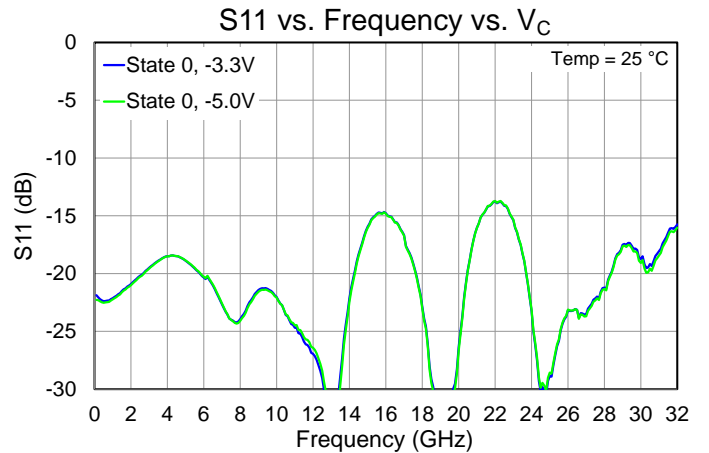
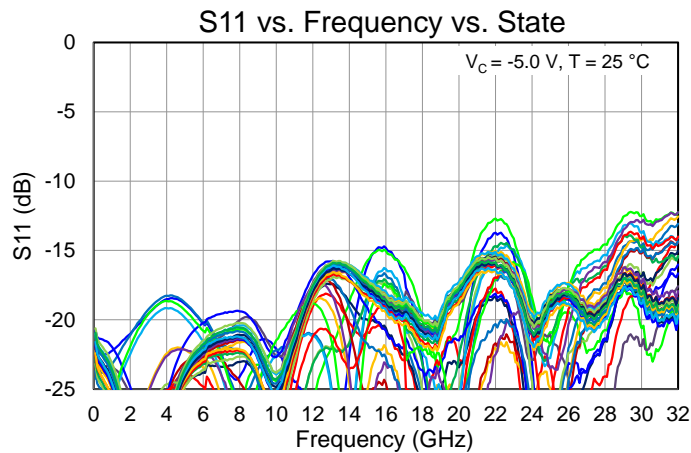
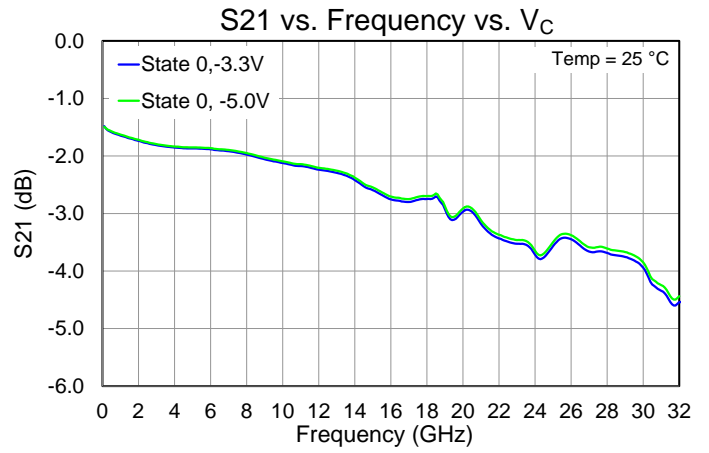
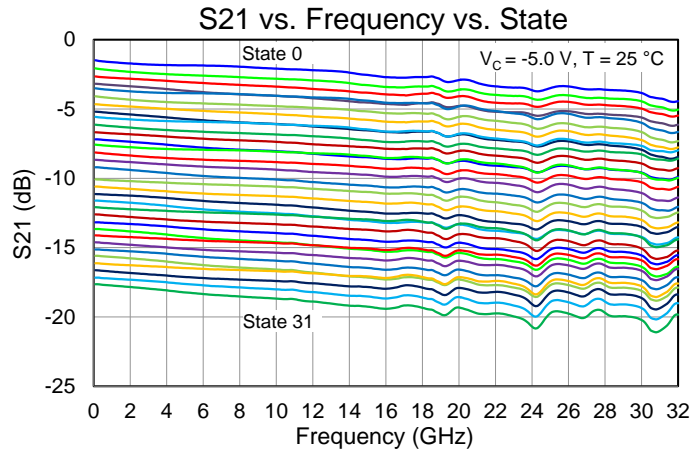

Performance Plots – Small Signal

Test conditions unless otherwise noted: Tested with DUT on EVB

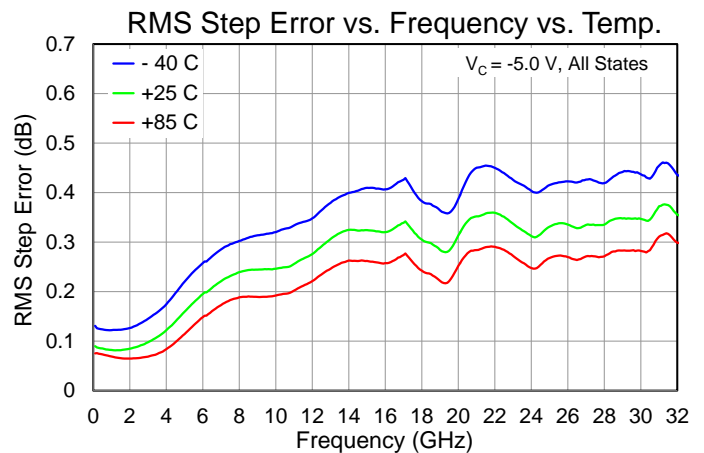
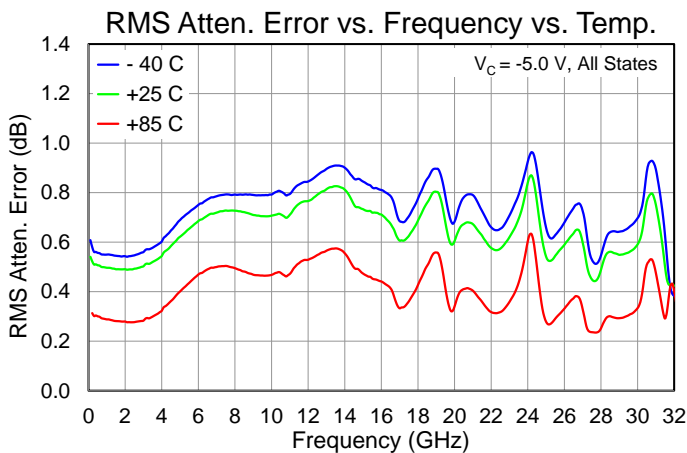
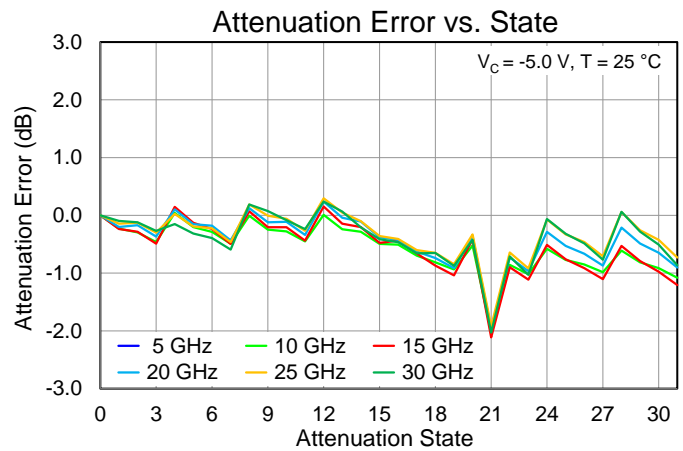
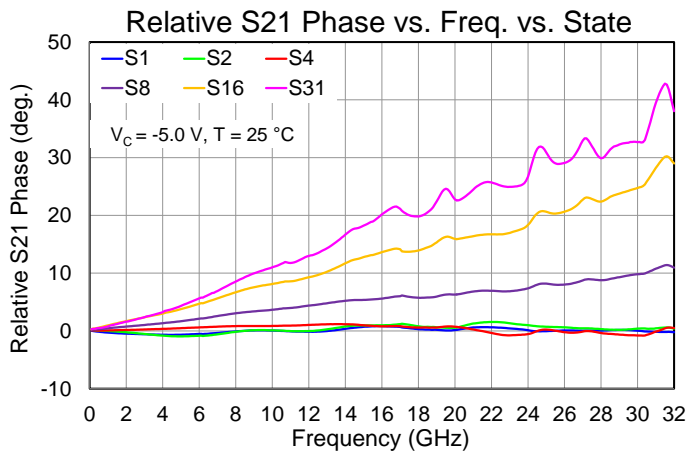
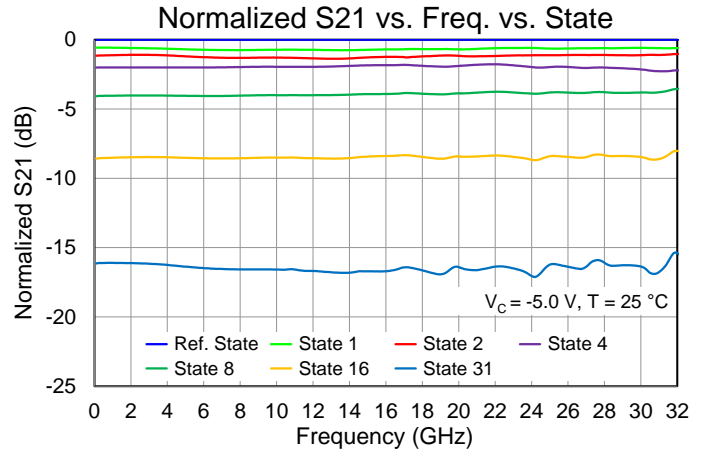
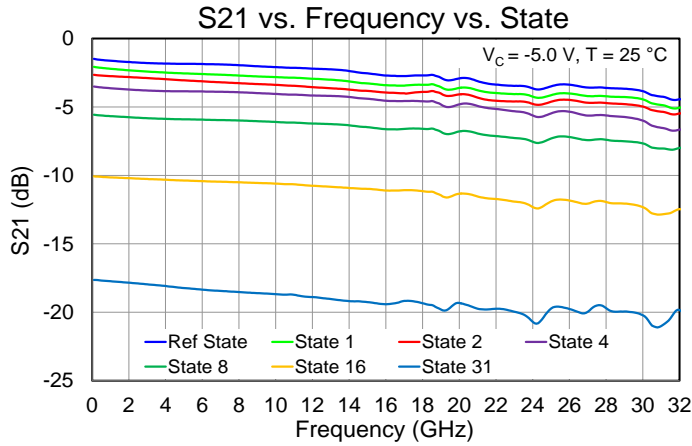

Performance Plots – Small Signal

Test conditions unless otherwise noted: Tested with DUT on EVB

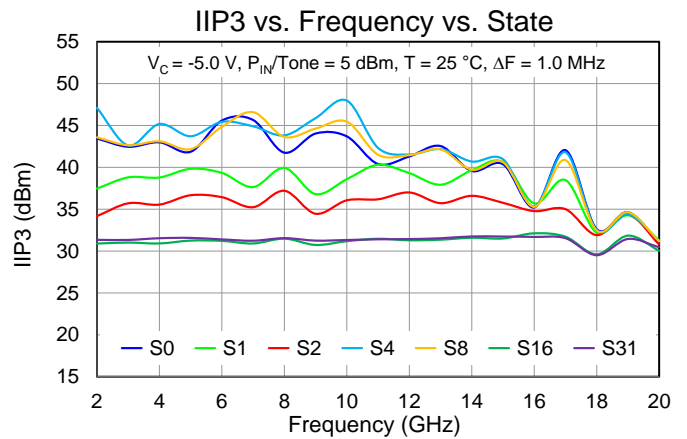
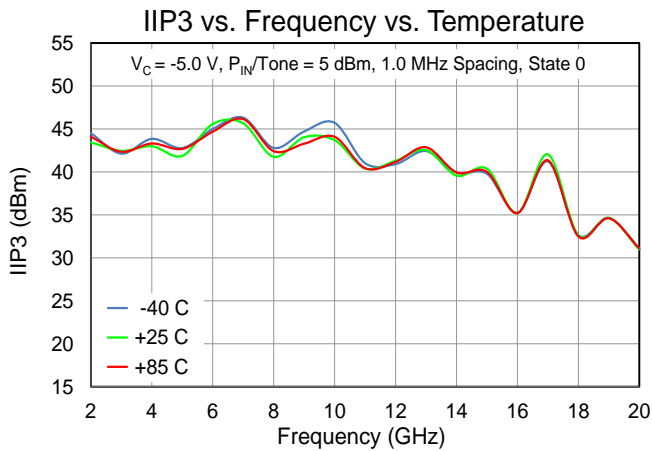
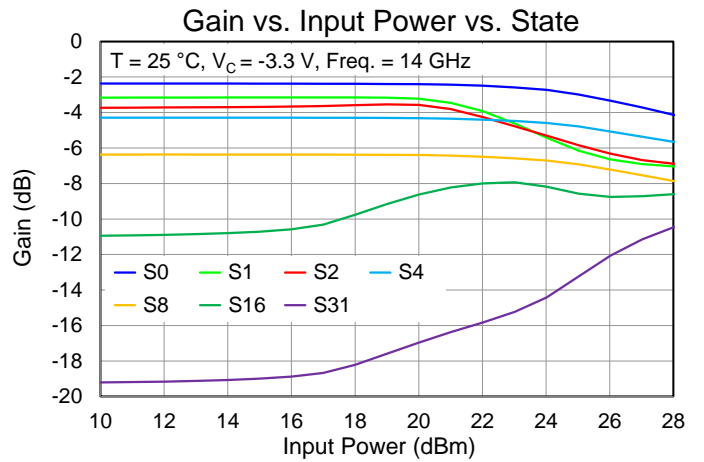
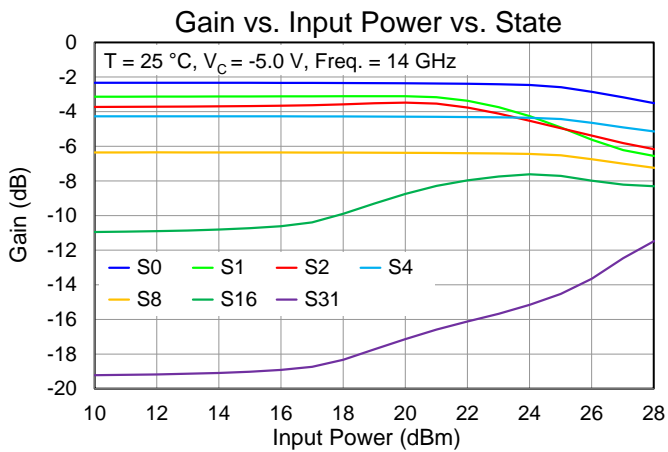
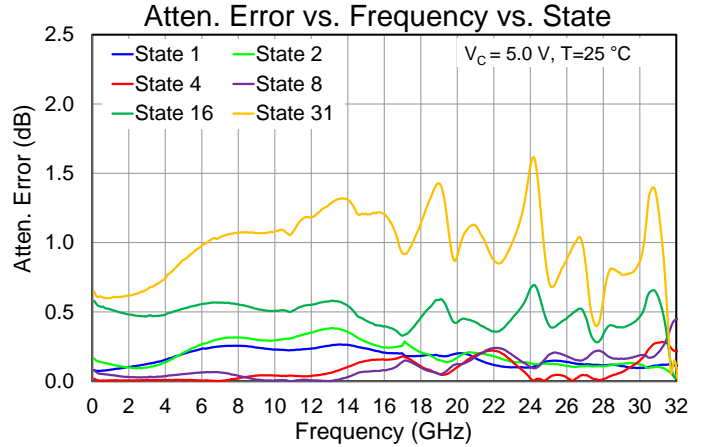
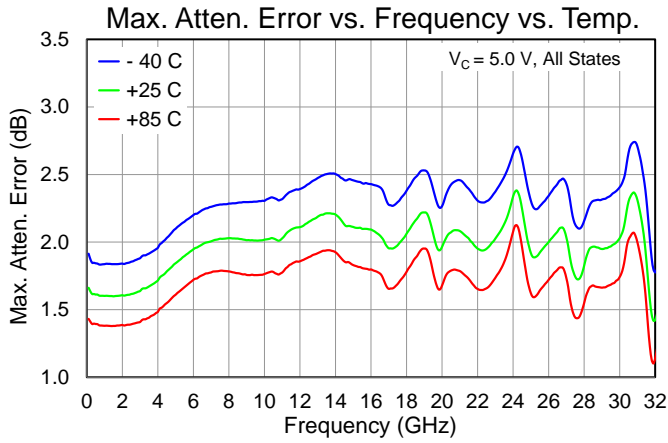

Thermal and Reliability Information

Parameter	Test Conditions	Value	Units
Thermal Resistance (θ_{JC}) ⁽¹⁾	$T_{BASE} = 85\text{ }^\circ\text{C}$, $V_C = -5.0\text{ V}$, $P_{DISS} = 0.22\text{ W}$	103.6	$^\circ\text{C/W}$
Channel Temperature (T_{CH})		108	$^\circ\text{C}$
Median Lifetime (T_M)		2.24E+8	Hrs

1. Package base backside temperature fixed at 85 $^\circ\text{C}$.

Median Lifetime

Test Conditions: 6.0 V; Failure Criterion = 10% reduction in $I_{D\text{ MAX}}$

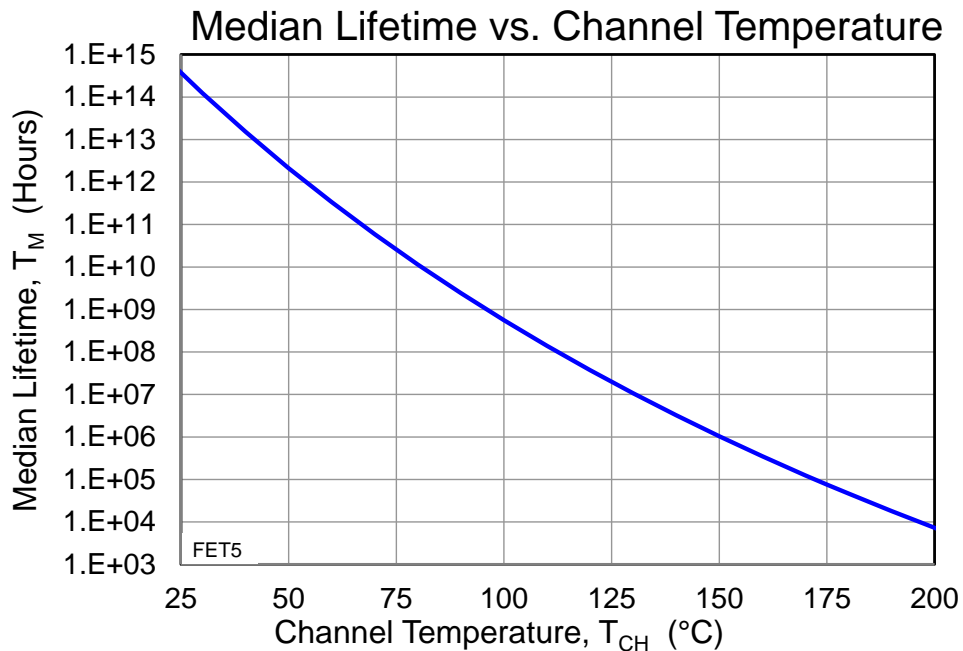

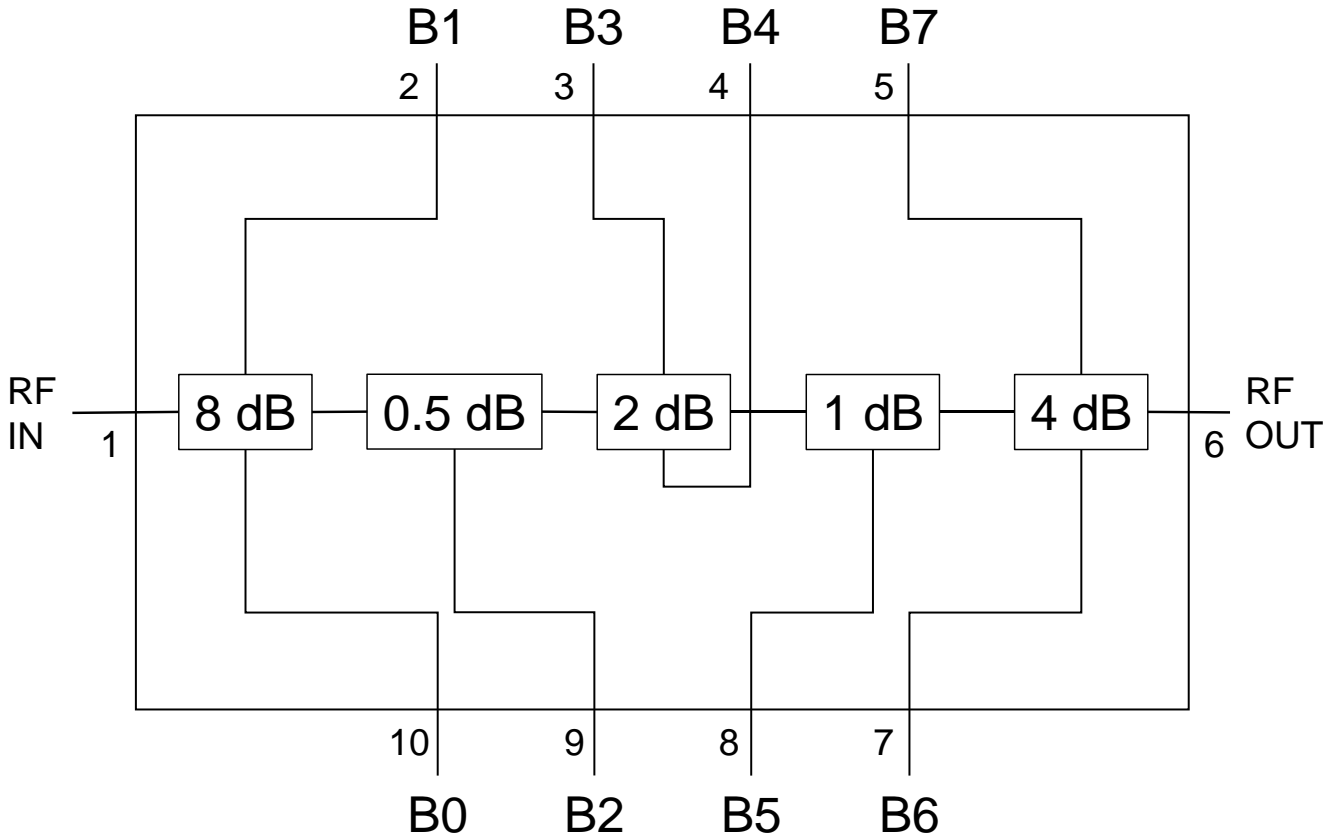
Applications Circuit

Function Table – Major States

Parameter	State	B0	B1	B2	B3	B4	B5	B6	B7
0.0 dB Attenuation (Ref. State)	State 0	1	0	0	0	1	0	1	0
0.5 dB Attenuation	State 1	1	0	1	0	1	0	1	0
1.0 dB Attenuation	State 2	1	0	0	0	1	1	1	0
2.0 dB Attenuation	State 4	1	0	0	1	0	0	1	0
4.0 dB Attenuation	State 8	1	0	0	0	1	0	0	1
8.0 dB Attenuation	State 16	0	1	0	0	1	0	1	0
15.5 dB Attenuation	State 31	0	1	1	1	0	1	0	1

Notes:

Logic H = 1 = 0 V. Logic L = 0 = -3.3 to -5.0 V

RF Input and Output are DC coupled

Evaluation Board (EVB) Layout Assembly & Mounting Detail

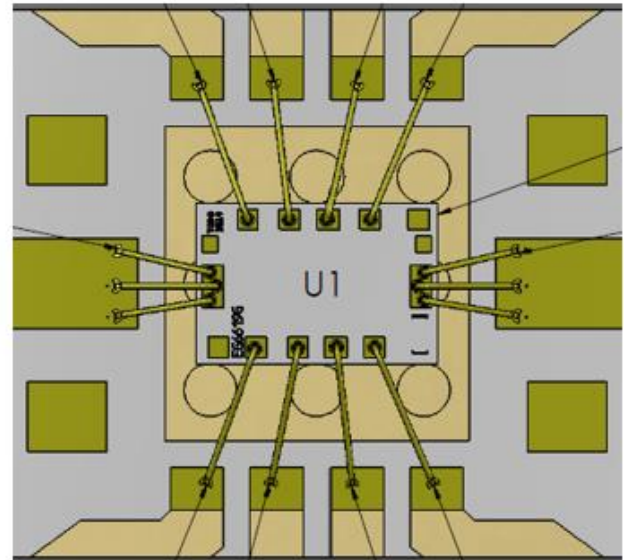
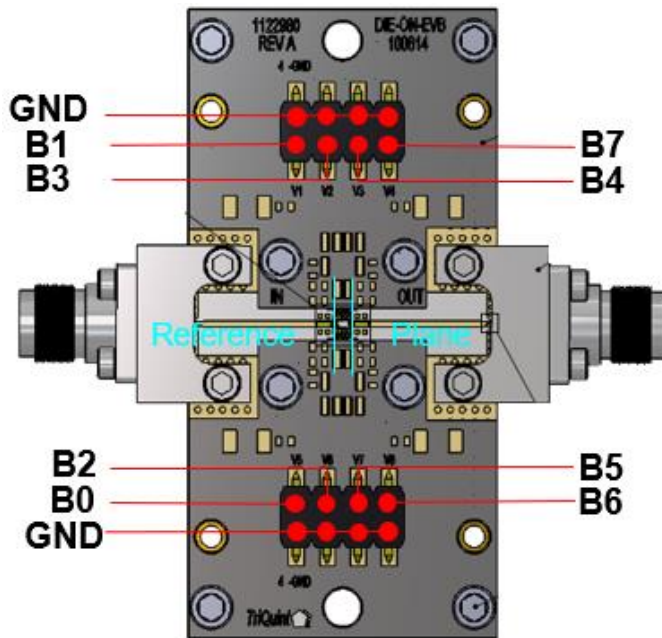

Notes:

RF Layer is 0.008" thick Rogers Corp. RO4003C, $\epsilon_r = 3.38$. Metal layers are 0.5 oz. copper.

The micro strip line at the connector interface is optimized for the Southwest Microwave end launch connector 1092-01A-5.

Multiple vias should be employed under die to minimize inductance and thermal resistance.

The PCB pattern shown has been developed and tested for optimal performance. The land pattern has been developed to accommodate lead and package tolerances. Since surface mount processes vary from company to company, careful process development is recommended.

Mechanical Information and Bond Pad Description

The dimensions are in millimeters and that unless otherwise noted the die size tolerance is +/- 0.050mm.

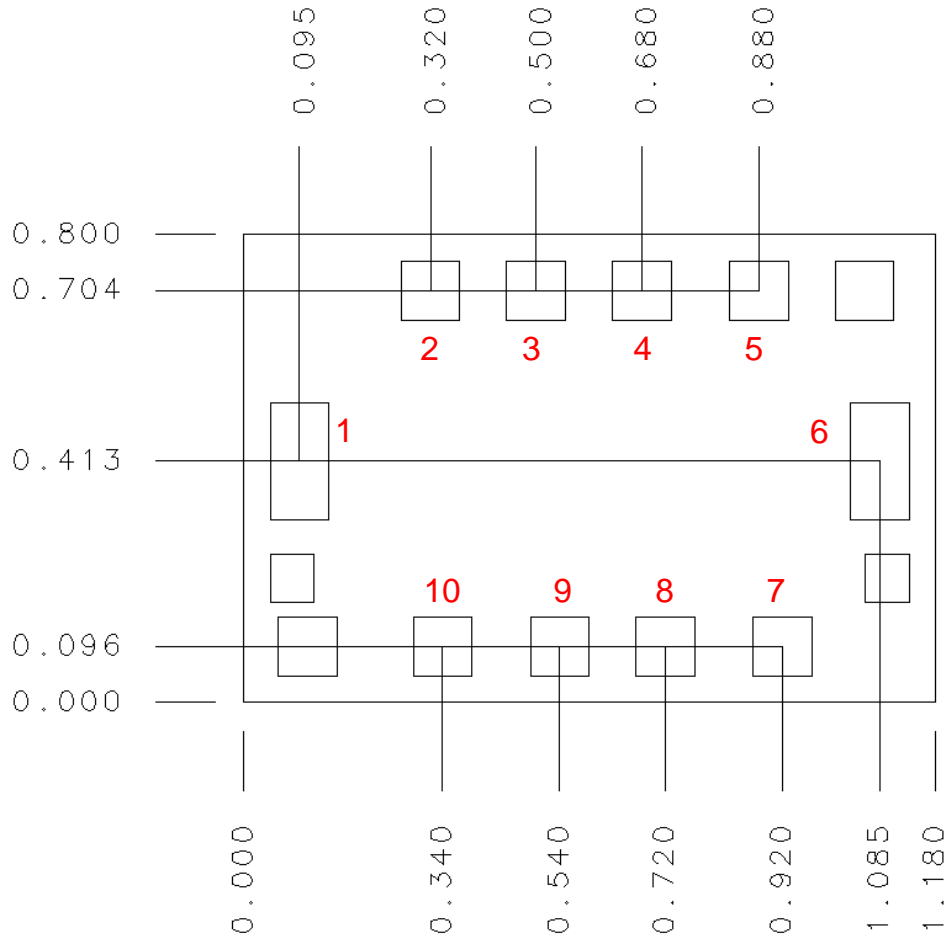

Pin No.	Symbol	Description	Pad Size (um x um)
1	RF Input	RF Input	100 x 200
2	B1	Complementary control line for 8.0 dB bit	100 x 100
3	B3	Complementary control line for 2.0 dB bit	100 x 100
4	B4	Complementary control line for 2.0 dB bit	100 x 100
5	B7	Complementary control line for 4.0 dB bit	100 x 100
6	RF Output	RF Output	100 x 200
7	B6	Complementary control line for 4.0 dB bit	100 x 100
8	B5	Control line for 1.0 dB bit	100 x 100
9	B2	Control line for 0.5 dB bit	100 x 100
10	B0	Complementary control line for 8.0 dB bit	100 x 100

Assembly Notes

Component placement and adhesive attachment assembly notes:

- Vacuum pencils and/or vacuum collets are the preferred method of pick up.
- Air bridges must be avoided during placement.
- The force impact is critical during auto placement.
- Organic attachment (i.e., conductive epoxy) can be used in low-power applications.
- Curing should be done in a convection oven; proper exhaust is a safety concern.

Reflow process assembly notes:

- Use AuSn (80/20) solder and limit exposure to temperatures above 300°C to 3-4 minutes, maximum.
- Conductive epoxy die attach is recommended for PCB mounting.
- Bonding pads plating: Au.
- An alloy station or conveyor furnace with reducing atmosphere should be used.
- Do not use any kind of flux.
- Coefficient of thermal expansion matching is critical for long-term reliability.
- Devices must be stored in a dry nitrogen atmosphere.

Interconnect process assembly notes:

- Thermosonic ball bonding is the preferred interconnect technique.
- Force, time, and ultrasonics are critical parameters.
- Aluminum wire should not be used.
- Devices with small pad sizes should be bonded with 0.0007-inch wire.

Handling Precautions

Parameter	Rating	Standard
ESD – Human Body Model (HBM)	0A	ESDA / JEDEC JS-001-2012
ESD – Charge Device Model (CDM)	TBD	EIA/JESD22-C101E



Caution!
ESD-Sensitive Device

RoHS Compliance

This product is compliant with the 2011/65/EU RoHS directive (Restrictions on the Use of Certain Hazardous Substances in Electrical and Electronic Equipment), as amended by Directive 2015/863/EU. This product also has the following attributes:

- Lead Free
- Halogen Free (Chlorine, Bromine)
- Antimony Free
- TBBP-A (C₁₅H₁₂Br₄O₂) Free
- PFOS Free
- SVHC Free

Contact Information

For the latest specifications, additional product information, worldwide sales and distribution locations:

Tel: 1-844-890-8163

Web: www.qorvo.com

Email: customer.support@qorvo.com

For technical questions and application information: **Email:** appsupport@qorvo.com

Important Notice

The information contained herein is believed to be reliable; however, Qorvo makes no warranties regarding the information contained herein and assumes no responsibility or liability whatsoever for the use of the information contained herein. All information contained herein is subject to change without notice. Customers should obtain and verify the latest relevant information before placing orders for Qorvo products. The information contained herein or any use of such information does not grant, explicitly or implicitly, to any party any patent rights, licenses, or any other intellectual property rights, whether with regard to such information itself or anything described by such information. **THIS INFORMATION DOES NOT CONSTITUTE A WARRANTY WITH RESPECT TO THE PRODUCTS DESCRIBED HEREIN, AND QORVO HEREBY DISCLAIMS ANY AND ALL WARRANTIES WITH RESPECT TO SUCH PRODUCTS WHETHER EXPRESS OR IMPLIED BY LAW, COURSE OF DEALING, COURSE OF PERFORMANCE, USAGE OF TRADE OR OTHERWISE, INCLUDING THE IMPLIED WARRANTIES OF MERCHANTABILITY AND FITNESS FOR A PARTICULAR PURPOSE.**

Without limiting the generality of the foregoing, Qorvo products are not warranted or authorized for use as critical components in medical, life-saving, or life-sustaining applications, or other applications where a failure would reasonably be expected to cause severe personal injury or death.

Copyright 2019 © Qorvo, Inc. | Qorvo is a registered trademark of Qorvo, Inc.

X-ON Electronics

Largest Supplier of Electrical and Electronic Components

Click to view similar products for [Attenuators](#) category:

Click to view products by [Qorvo](#) manufacturer:

Other Similar products are found below :

[ATN3580-01](#) [HMC305SLP4ETR](#) [MAAD-009195-000100](#) [TGL4201-00](#) [TGL4201-02](#) [TGL4201-03](#) [TGL4201-06](#) [TGL4201-10](#) [ATN3590-15](#) [20-50TPC](#) [D10AA5Z4](#) [18AH-01](#) [18AH-08](#) [ATN3580-20](#) [ATN3590-09](#) [20-50RP](#) [MASW-008322-000000](#) [MAATCC0009TR](#) [PCAF-10](#) [EXB-24AT9AR5X](#) [ATN3580-10](#) [HMC539ALP3ETR](#) [ATN3580-02](#) [WA04P006XCTL](#) [SKY12408-321LF](#) [ATN3580-03](#) [WA04P005XBTL](#) [HMC-VVD104-SX](#) [WA04P007XCTL](#) [SKY12236-11](#) [MAATSS0018TR-3000](#) [HMC656-SX](#) [WA04P001XBTL](#) [MAAV-007941-TR3000](#) [WA04P004XBTL](#) [WA04P002XBTL](#) [HMC941A](#) [PAT0816-C-0DB-T5](#) [PAT0816-C-8DB-T5](#) [PAT1632-C-3DB-T1](#) [PAT1632-C-6DB-T1](#) [PAT1632-C-10DB-T1](#) [PAT1632-C-1DB-T1](#) [PAT0816-C-2DB-T5](#) [PAT0816-C-4DB-T5](#) [DHM510-0100-006](#) [CMD172](#) [MAT10300](#) [MAT10180](#) [MAATCC0007-TB](#)