

Product Description

Qorvo's TGL2226 is a wideband, 6-bit digital attenuator fabricated using Qorvo's production 0.15um GaAs pHEMT process (QPHT15). Operating from 0.1–15 GHz, the TGL2226 offers a low LSB of 0.5 dB and supports 31.5 dB of attenuation range with a low insertion loss from 2.8–3.8 dB over frequency and a low RMS attenuation error of less than 2.0 dB.

Using standard, negative control voltages from –3.0 V to –5.0 V, coupled with excellent broadband performance, the TGL2226 is ideal for supporting a variety of commercial and military applications.

The TGL2226 is in die form, 1.180 x 1.000 x 0.100 mm, with both RF ports matched to 50 ohms for simple system integration.

Lead-free and RoHS compliant.

Evaluation Boards available on request.

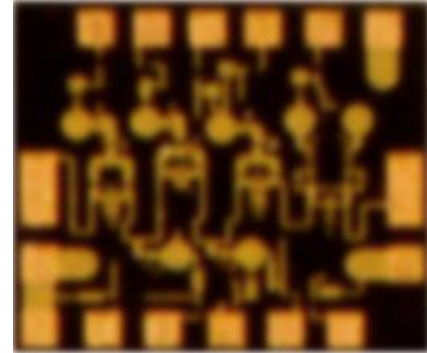

Product Features

- Frequency Range: 0.1 – 15 GHz
- 6-Bit Digital Attenuator
- Attenuation Step Size (LSB): 0.5 dB
- Attenuation Range: 31.5 dB
- Insertion Loss (Ref. State): 2.6 – 3.8 dB
- RMS Attenuation Error: < 2.0 dB
- Control Voltage: -3.0 to 5.0 V
- Die Size: 1.180 x 1.000 x 0.100 mm

Performance is typical across frequency. Please reference electrical specification table and data plots for more details.

Block Diagram

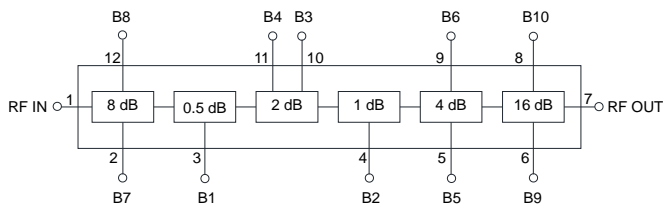

Applications

- Commercial and Military Radar
- Electronic Warfare
- Satellite Communications
- Point to Point Radio
- General Purpose

Ordering Information

Part No.	ECCN	Description
TGL2226	EAR99	0.1–15 GHz 6-Bit Digital Attenuator

Electrical Specifications

Test conditions, unless otherwise noted: 25 °C, $V_C = 0 / -5.0$ V. Tested with DUT on EVB, reference plane at MMIC bond wires.

Parameter	Min	Typ	Max	Units
Operational Frequency Range	0.1	–	15	GHz
LSB Attenuation		0.5		dB
Attenuation Range		31.5		dB
Reference State Insertion Loss: 0.1 – 5 GHz		< 2.8		dB
Reference State Insertion Loss: 5 – 10 GHz		< 3.3		dB
Reference State Insertion Loss: 10 – 15 GHz		< 3.8		dB
Input Return Loss		> 10		dB
Output Return Loss		> 12		dB
IIP3 ($\Delta f = 1.0$ MHz, $P_{IN}/Tone = 5$ dBm, 8 GHz, major states)		> 31.5		dBm
Switching Speed (10%-90%, 90%-10%)		< 30		ns
RMS Attenuation Error		< 2.0		dB
Max. Attenuation Error		< 5.0		dB

Recommended Operating Conditions

Parameter	Value / Range
Control Voltage (logic L) ¹	-5 V
Control Voltage (logic H)	0 V

¹ Control voltage down to -3.0V is acceptable

Electrical specifications are measured at specified test conditions.
Specifications are not guaranteed over all recommended operating conditions.

Absolute Maximum Ratings

Parameter	Value / Range
Control Voltage (V_C)	-6 V
Control Current (I_C)	1 mA
Input Power, (P_{IN})	23 dBm
Power Dissipation (P_{DISS})	0.7 W
Operating Channel Temperature (T_{CH})	150 °C
Mounting Temperature (30 Seconds)	260 °C
Storage Temperature	-55 to 150 °C

Operation of this device outside the parameter ranges given above may cause permanent damage. These are stress ratings only, and functional operation of the device at these conditions is not implied.

Performance Plots – Small Signal

2 GHz discontinuity on S11 & S22 plots are due to calibration artifact

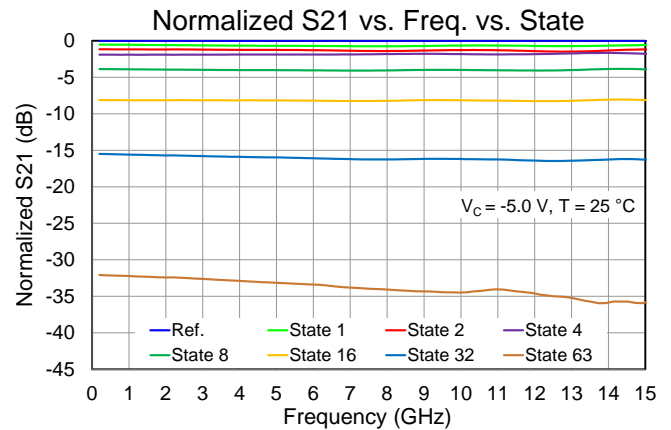
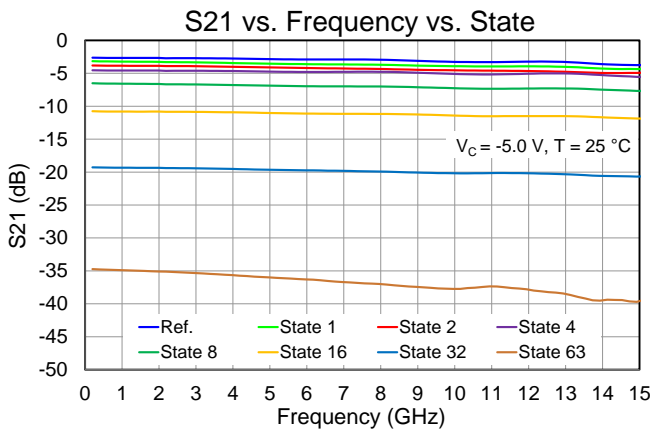
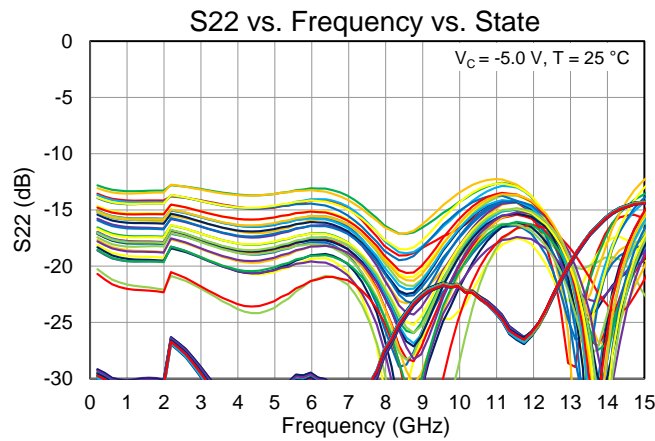
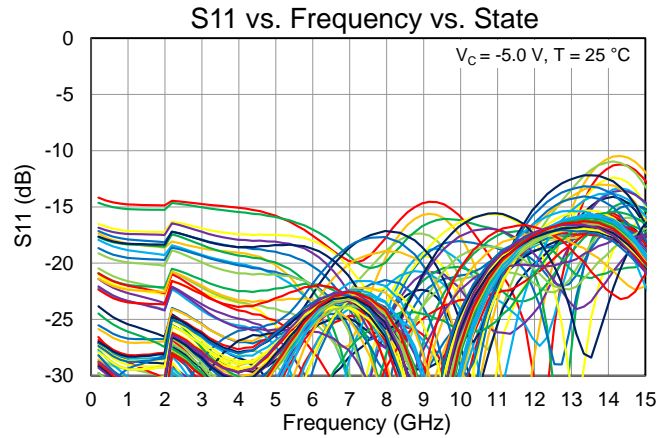
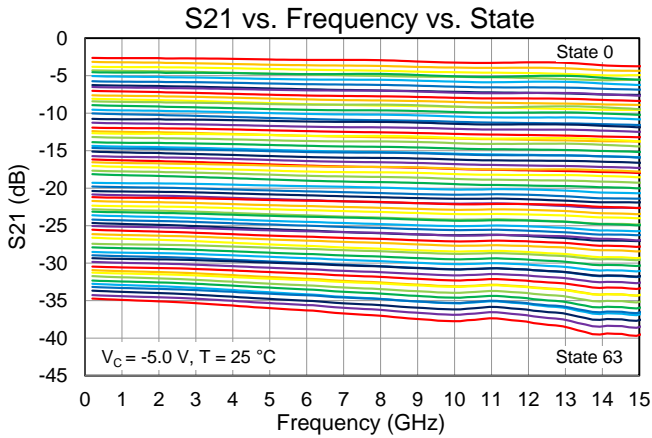

Performance Plots – Small Signal

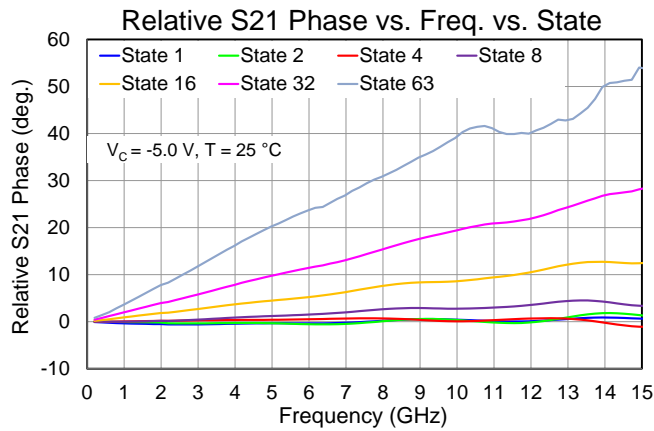
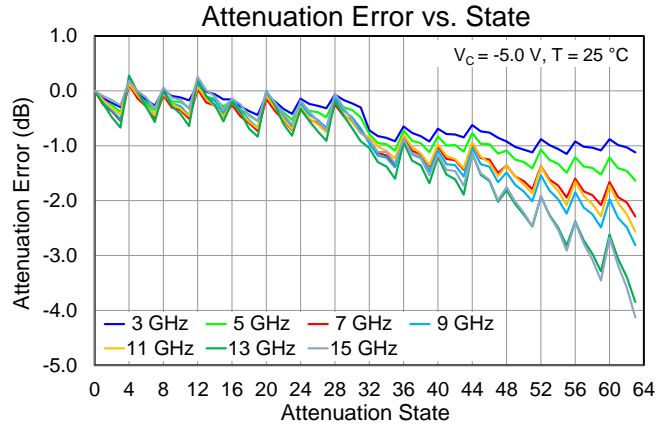
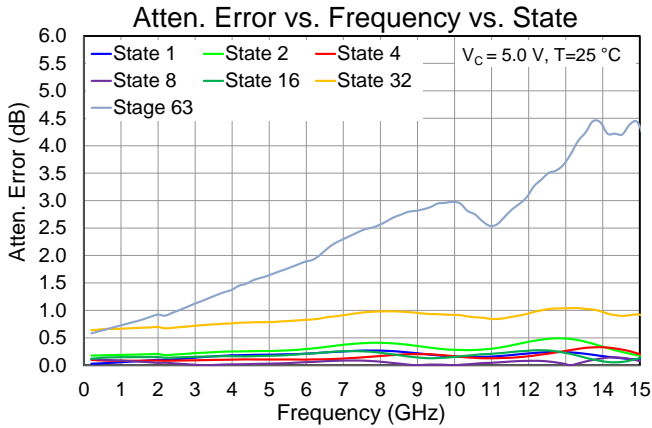
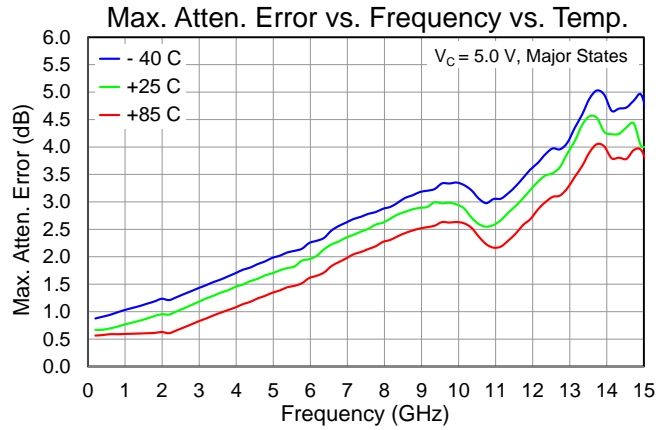
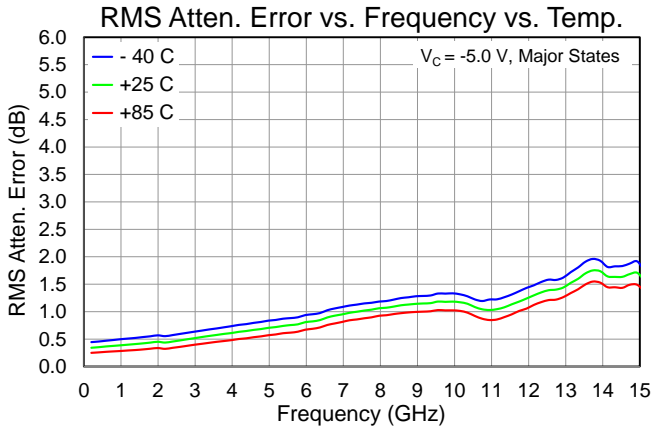

Performance Plots – Large Signal & Linearity

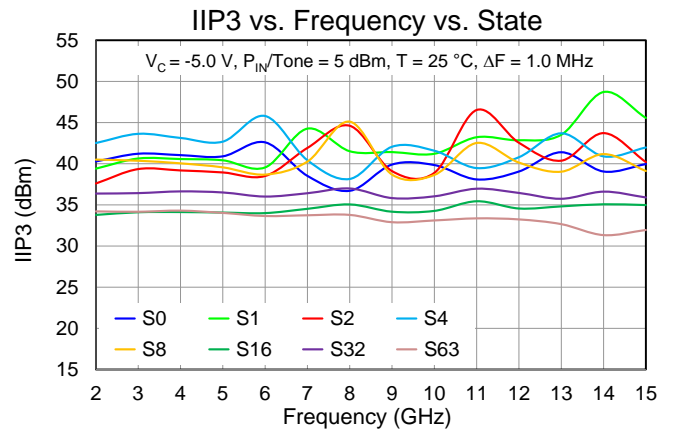
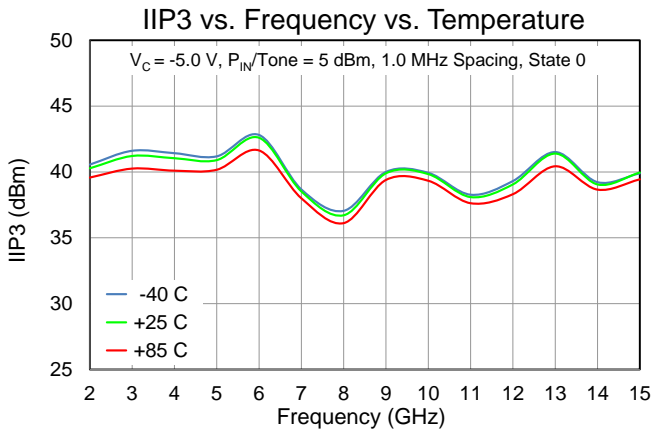
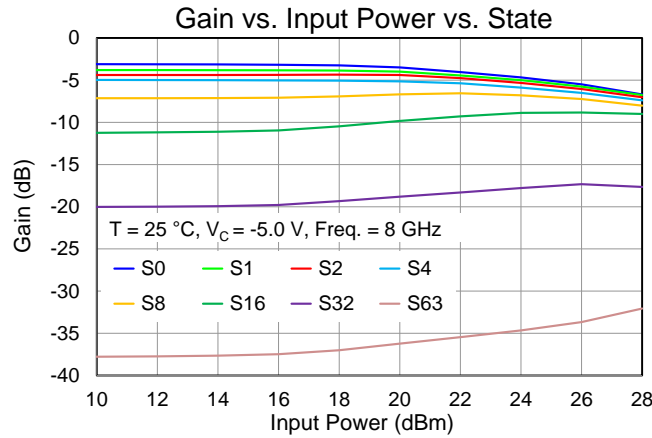

Thermal and Reliability Information

Parameter	Test Conditions	Value	Units
Thermal Resistance (θ_{JC}) ⁽¹⁾	$T_{BASE} = 85\text{ }^{\circ}\text{C}$, $V_C = -5.0\text{ V}$, $P_{IN} = 23\text{ dBm}$, $P_{DISS} = 0.105\text{ W}$	56.9	$^{\circ}\text{C/W}$
Channel Temperature (T_{CH})		102	$^{\circ}\text{C}$
Median Lifetime (T_M)		5.6E+8	Hrs

1. Carrier plate backside temperature fixed at 85 $^{\circ}\text{C}$.

Median Lifetime

Test Conditions: 6.0 V; Failure Criterion = 10% reduction in $I_{D\text{ MAX}}$

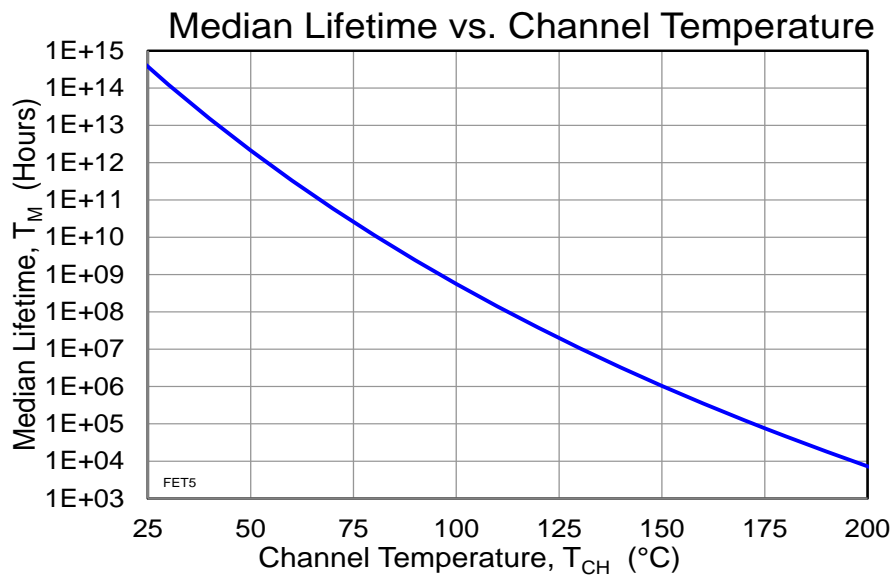

Applications Circuit

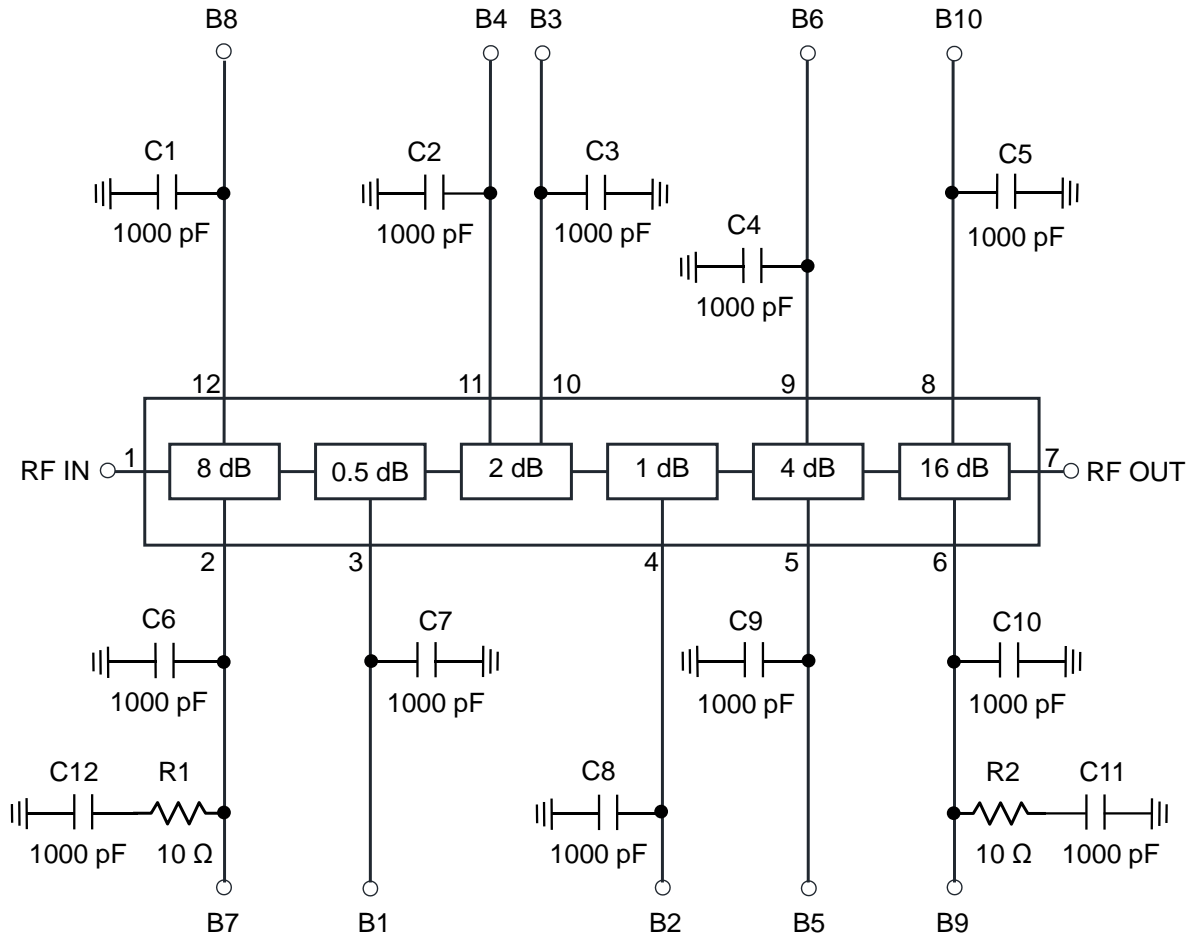

Function Table – Major States

Parameter	State	B1	B2	B3	B4	B5	B6	B7	B8	B9	B10
0.0 dB Attenuation (Ref. State)	State 0	0	0	1	0	1	0	1	0	1	0
0.5 dB Attenuation	State 1	1	0	1	0	1	0	1	0	1	0
1.0 dB Attenuation	State 2	0	1	1	0	1	0	1	0	1	0
2.0 dB Attenuation	State 4	0	0	0	1	1	0	1	0	1	0
4.0 dB Attenuation	State 8	0	0	1	0	0	1	1	0	1	0
8.0 dB Attenuation	State 16	0	0	1	0	1	0	0	1	1	0
16.0 dB Attenuation	State 32	0	0	1	0	1	0	1	0	0	1
31.5 dB Attenuation	State 63	1	1	0	1	0	1	0	1	0	1

Intermediate attenuation states are combinations of the above major states.

Logic H = 0 V. Logic L = -3.0 to -5.0 V

Note: RF Input and RF Output are both DC coupled.

Evaluation Board (EVB) Layout Assembly & Mounting Detail

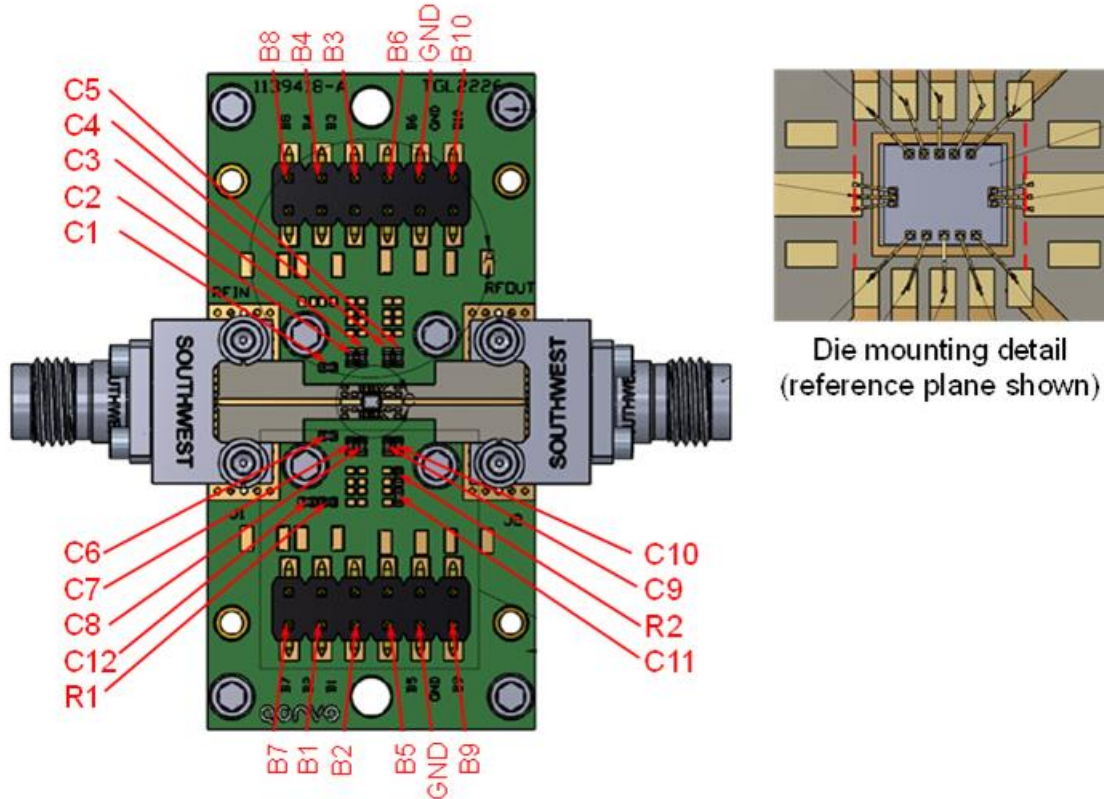

RF Layer is 0.008” thick Rogers Corp. RO4003C, er = 3.38. Metal layers are 0.5 oz. copper. The microstrip line at the connector interface is optimized for the Southwest Microwave end launch connector 1492-04A-5.

Reference plane is at the MMIC bondwires.

Note: Multiple vias should be employed under die to minimize inductance and thermal resistance.

Bill of Materials for EVB

Reference Des.	Value	Description	Manuf.	Part Number
C1 – C12	1000 pF	CAP, 0402, 50 V, 10 %, X7R	Various	–
R1 – R2	10 Ohm	RES, 0402, 5 %, SMD	Various	–

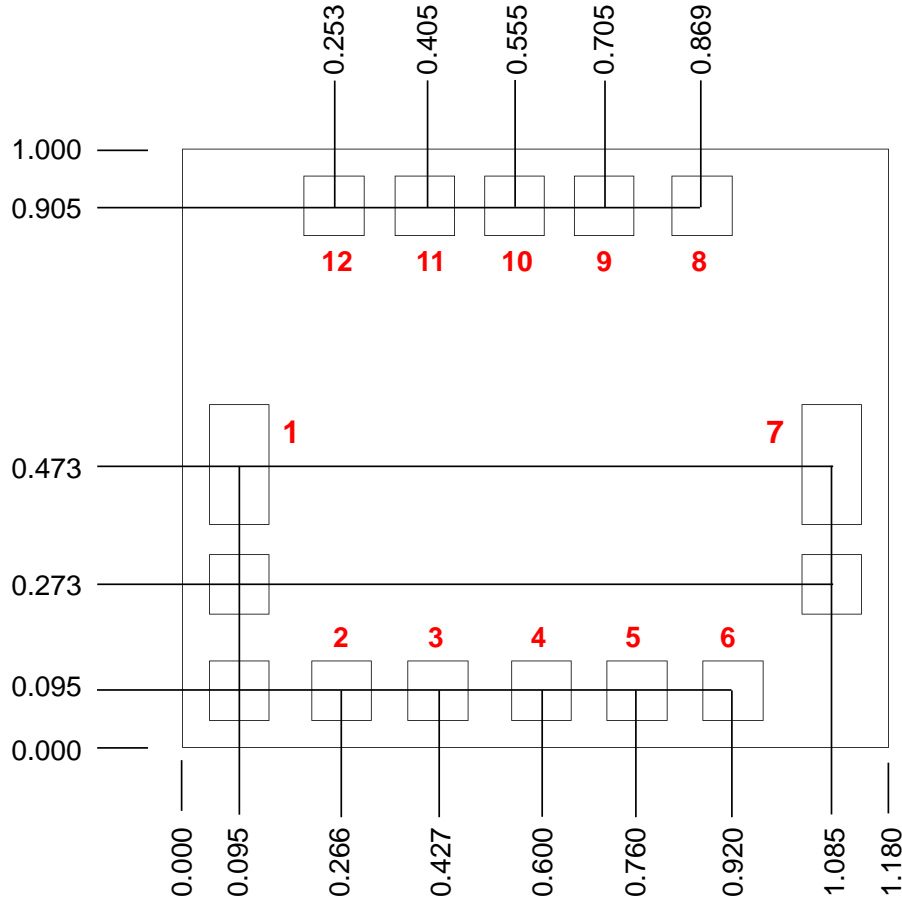
Mechanical Drawing and Bond Pad Description

Pin No.	Symbol	Description	Pad Size (um x um)
1	RF IN	RF Input; DC coupled	100 x 200
2	B7	Control Line for 8.0 dB bit (complement of B8)	100 x 100
3	B1	Control Line for 0.5 dB bit	100 x 100
4	B2	Control Line for 1.0 dB bit	100 x 100
5	B5	Control Line for 4.0 dB bit (complement of B6)	100 x 100
6	B9	Control Line for 16.0 dB bit (complement of B10)	100 x 100
7	RF OUT	RF Output; DC coupled	100 x 200
8	B10	Control Line for 16.0 dB bit	100 x 100
9	B6	Control Line for 4.0 dB bit	100 x 100
10	B3	Control Line for 2.0 dB bit (complement of B4)	100 x 100
11	B4	Control Line for 2.0 dB bit	100 x 100
12	B8	Control Line for 8.0 dB bit	100 x 100

Assembly Notes

Component placement and adhesive attachment assembly notes:

- Vacuum pencils and/or vacuum collets are the preferred method of pick up.
- Air bridges must be avoided during placement.
- The force impact is critical during auto placement.
- Organic attachment (i.e., conductive epoxy) can be used in low-power applications.
- Curing should be done in a convection oven; proper exhaust is a safety concern.

Reflow process assembly notes:

- Use AuSn (80/20) solder and limit exposure to temperatures above 300 °C to 3–4 minutes, maximum.
- An alloy station or conveyor furnace with reducing atmosphere should be used.
- Do not use any kind of flux.
- Coefficient of thermal expansion matching is critical for long-term reliability.
- Devices must be stored in a dry nitrogen atmosphere.

Interconnect process assembly notes:

- Thermosonic ball bonding is the preferred interconnect technique.
- Force, time, and ultrasonic are critical parameters.
- Aluminum wire should not be used.
- Devices with small pad sizes should be bonded with 0.0007-inch wire.

Handling Precautions

Parameter	Rating	Standard		Caution! ESD-Sensitive Device
ESD – Human Body Model (HBM)	TBD	ESDA / JEDEC JS-001-2012		

Solderability

Compatible with both lead-free (260°C max. reflow temp.) and tin/lead (245°C max. reflow temp.) soldering processes. Solder profiles available upon request.

RoHS Compliance

This product is compliant with the 2011/65/EU RoHS directive (Restrictions on the Use of Certain Hazardous Substances in Electrical and Electronic Equipment), as amended by Directive 2015/863/EU. This product also has the following attributes:

- Lead Free
- Halogen Free (Chlorine, Bromine)
- Antimony Free
- TBBP-A (C₁₅H₁₂Br₄O₂) Free
- PFOS Free
- SVHC Free
- Qorvo Green



Contact Information

For the latest specifications, additional product information, worldwide sales and distribution locations:

Tel: 1-844-890-8163

Web: www.qorvo.com

Email: customer.support@qorvo.com

For technical questions and application information: **Email: appsupport@qorvo.com**

Important Notice

The information contained herein is believed to be reliable; however, Qorvo makes no warranties regarding the information contained herein and assumes no responsibility or liability whatsoever for the use of the information contained herein. All information contained herein is subject to change without notice. Customers should obtain and verify the latest relevant information before placing orders for Qorvo products. The information contained herein or any use of such information does not grant, explicitly or implicitly, to any party any patent rights, licenses, or any other intellectual property rights, whether with regard to such information itself or anything described by such information. **THIS INFORMATION DOES NOT CONSTITUTE A WARRANTY WITH RESPECT TO THE PRODUCTS DESCRIBED HEREIN, AND QORVO HEREBY DISCLAIMS ANY AND ALL WARRANTIES WITH RESPECT TO SUCH PRODUCTS WHETHER EXPRESS OR IMPLIED BY LAW, COURSE OF DEALING, COURSE OF PERFORMANCE, USAGE OF TRADE OR OTHERWISE, INCLUDING THE IMPLIED WARRANTIES OF MERCHANTABILITY AND FITNESS FOR A PARTICULAR PURPOSE.**

Without limiting the generality of the foregoing, Qorvo products are not warranted or authorized for use as critical components in medical, life-saving, or life-sustaining applications, or other applications where a failure would reasonably be expected to cause severe personal injury or death.

Copyright 2016 © Qorvo, Inc. | Qorvo is a registered trademark of Qorvo, Inc.

X-ON Electronics

Largest Supplier of Electrical and Electronic Components

Click to view similar products for [Attenuators](#) category:

Click to view products by [Qorvo](#) manufacturer:

Other Similar products are found below :

[HMC305SLP4ETR](#) [MAAD-009195-000100](#) [TGL4201-00](#) [TGL4201-02](#) [TGL4201-03](#) [TGL4201-06](#) [TGL4201-10](#) [ATN3590-15](#) [20-50TPC](#)
[D10AA5Z4](#) [18AH-01](#) [18AH-08](#) [ATN3580-20](#) [ATN3590-09](#) [20-50RP](#) [MASW-008322-000000](#) [PCAF-10](#) [EXB-24AT9AR5X](#) [ATN3580-06](#)
[ATN3580-10](#) [HMC539ALP3ETR](#) [ATN3580-02](#) [ATN3590-07](#) [SKY12408-321LF](#) [ATN3580-03](#) [WA04P005XBTL](#) [HMC-VVD104-SX](#)
[WA04P007XCTL](#) [SKY12236-11](#) [MAATSS0018TR-3000](#) [HMC656-SX](#) [WA04P001XBTL](#) [WA04P004XBTL](#) [WA04P002XBTL](#) [C3A50Z4](#)
[HMC941A](#) [PAT0816-C-0DB-T5](#) [PAT0816-C-8DB-T5](#) [PAT1632-C-3DB-T1](#) [PAT1632-C-6DB-T1](#) [PAT1632-C-10DB-T1](#) [PAT1632-C-1DB-](#)
[T1](#) [PAT0816-C-2DB-T5](#) [PAT0816-C-4DB-T5](#) [DHM510-0100-006](#) [CMD172](#) [MAT10300](#) [MAT10180](#) [MAATCC0007-TB](#) [MAATCC0011](#)