

Product Description

Qorvo's TGL2226-SM is a wideband, 6-bit digital attenuator fabricated using Qorvo's production 0.15um GaAs pHEMT process (QPHT15). Operating from 0.1–15 GHz, the TGL2226-SM offers a low LSB of 0.5 dB and provides 31.5 dB of attenuation range while supporting low insertion loss and RMS attenuation errors.

Using standard, negative control voltages from -3.0 V to -5.0 V coupled with excellent broadband performance, the TGL2226-SM is ideal for supporting a variety of commercial and military applications.

The TGL2226-SM is packaged in a 3.0 x 3.0 mm surface mount package, with both RF ports matched to 50 ohms for simple system integration.

Lead-free and RoHS compliant.

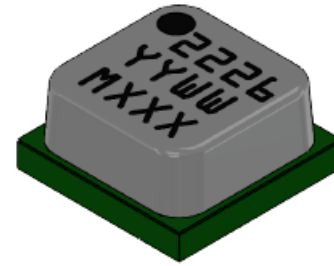

3 x 3 mm Air Cavity Laminate Package

Product Features

- Frequency Range: 0.1 – 15 GHz
- 6-Bit Digital Attenuator
- Attenuation Step Size (LSB): 0.5 dB
- Attenuation Range: 31.5 dB
- Insertion Loss (Ref. State): 3.0 – 4.0 dB
- RMS Attenuation Error: < 2.2 dB
- Control Voltage: -3.0 to -5.0 V
- Package Size: 3.0 x 3.0 x 1.5 mm

Performance is typical across frequency. Please reference electrical specification table and data plots for more details.

Block Diagram

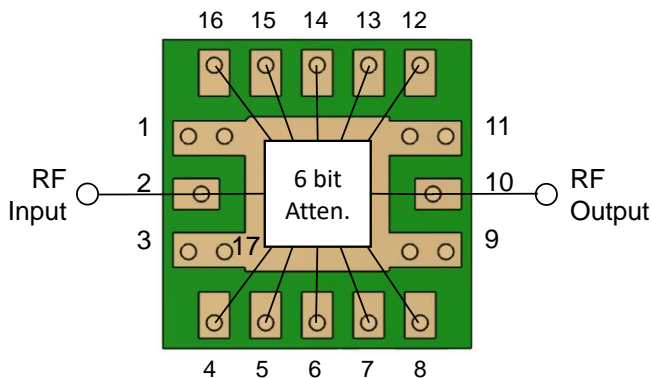

Applications

- Commercial and Military Radar
- Electronic Warfare
- Satellite Communications
- Point to Point Radio
- General Purpose

Ordering Information

Part No.	Description
1133544	0.1–15 GHz 6-Bit Digital Attenuator
1133547	TGL2226-SM EVAL BOARD

Absolute Maximum Ratings

Parameter	Value/Range
Control Voltage (V _C)	-6 V
Control Current (I _C)	1 mA
Input Power (P _{IN})	23 dBm
Power Dissipation (P _{DISS})	0.7 W
Mounting Temperature (30 seconds)	260 °C
Operating Channel Temperature	150 °C
Storage Temperature	-55 to 150 °C

Operation of this device outside the parameter ranges given above may cause permanent damage. These are stress ratings only, and functional operation of the device at these conditions is not implied.

Recommended Operating Conditions

Parameter	Value/Range
Control Voltage ¹ (V _C) - Logic 0 (L)	- 5 V
Control Voltage (V _C) – Logic 1 (H)	0 V
Operating Temperature Range	-40 to +85 °C

Note: ¹ Control Voltage down to -3 V is acceptable.

Electrical specifications are measured at specified test conditions. Specifications are not guaranteed over all recommended operating conditions.

Electrical Specifications

Test conditions, unless otherwise noted: 25 °C, V_C = 0 / -5.0 V. Tested with DUT on EVB, reference plane at package.

Parameter	Min	Typ.	Max	Units
Operational Frequency Range	0.1	–	15	GHz
LSB Attenuation		0.5		dB
Attenuation Range		31.5		dB
Reference State Insertion Loss: 0.1 – 5 GHz		< 3.0		dB
Reference State Insertion Loss: 5 – 10 GHz		< 3.6		dB
Reference State Insertion Loss: 10 – 15 GHz		< 4.0		dB
Input Return Loss		> 13		dB
Output Return Loss		> 11		dB
IIP3 (Δf= 1.0 MHz, P _{IN} /Tone = 5 dBm, 8 GHz)		> 31.5		dBm
Switching Speed (10%-90%, 90%-10%)		< 30		ns
RMS Attenuation Error		< 2.2		dB
Max. Attenuation Error		< 5.7		dB

Performance Plots – Small Signal

2 GHz discontinuity on S11 & S22 plots are due to calibration artifact

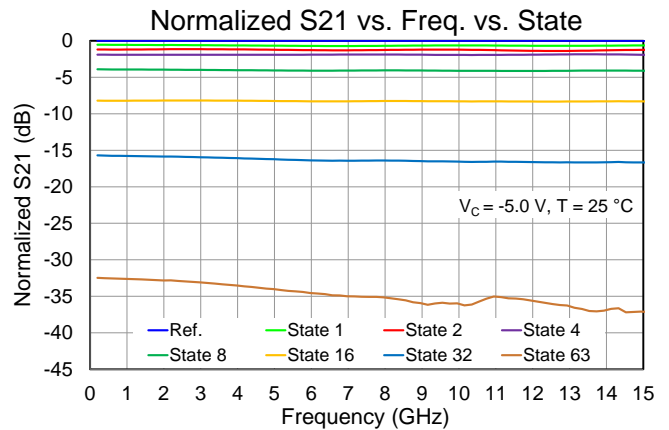
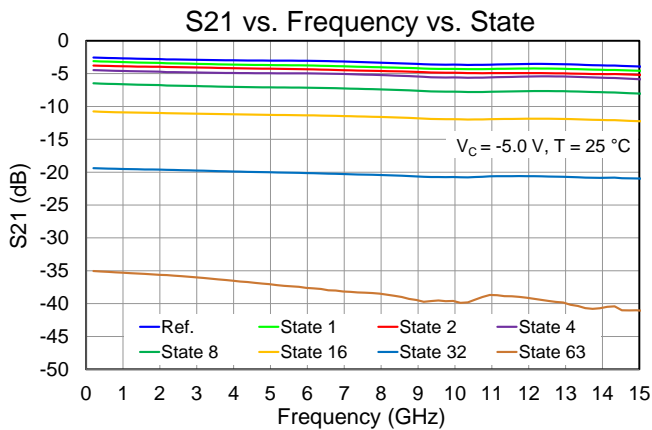
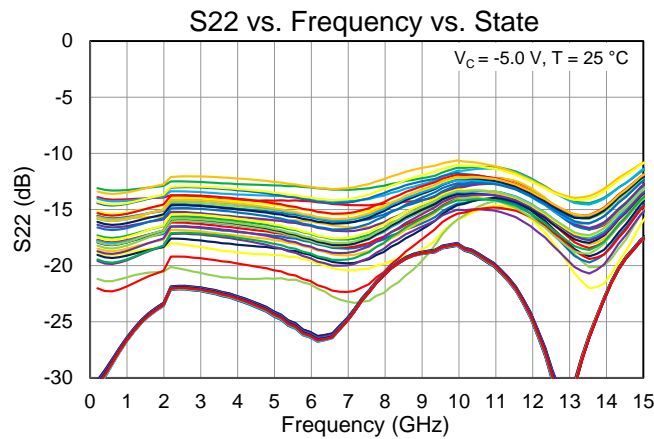
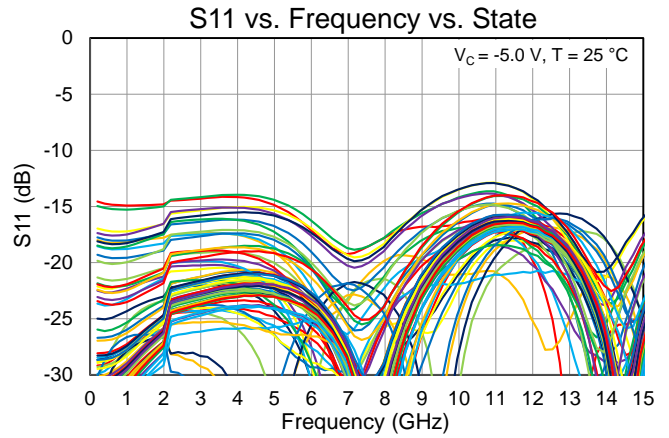
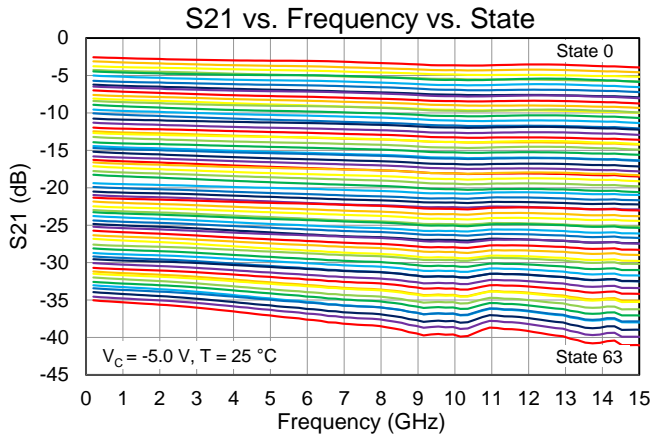

Performance Plots – Small Signal

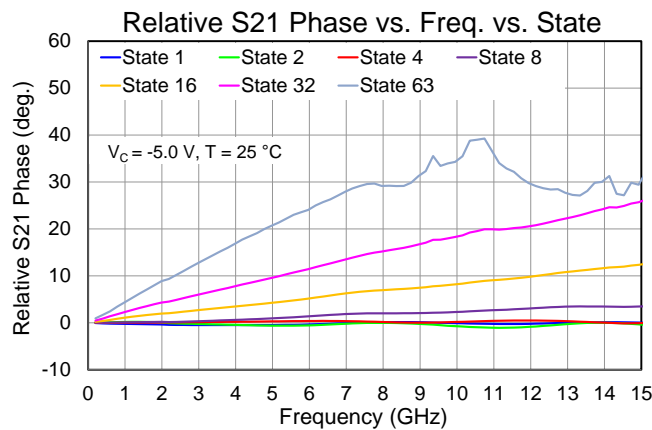
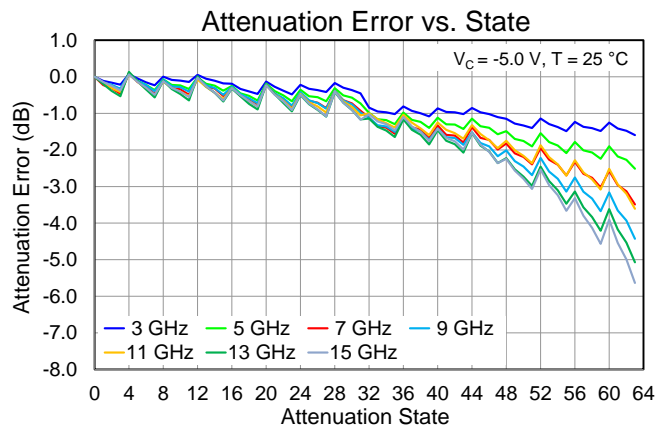
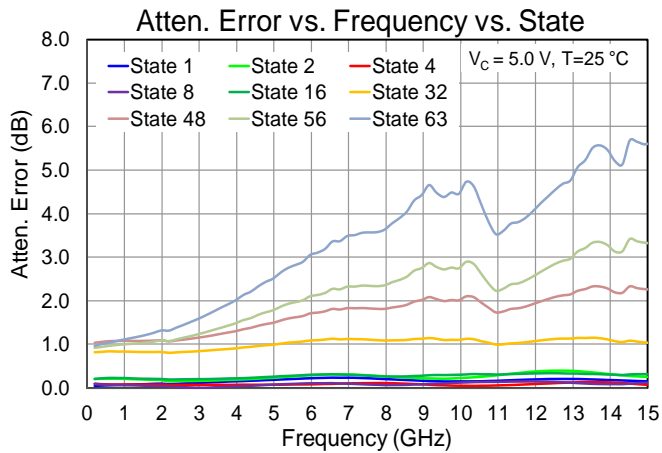
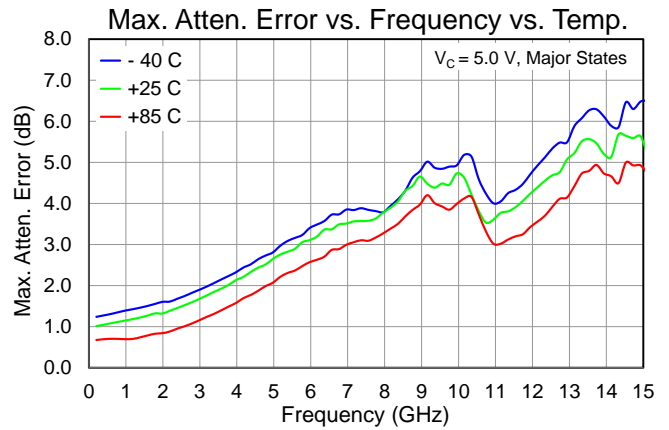
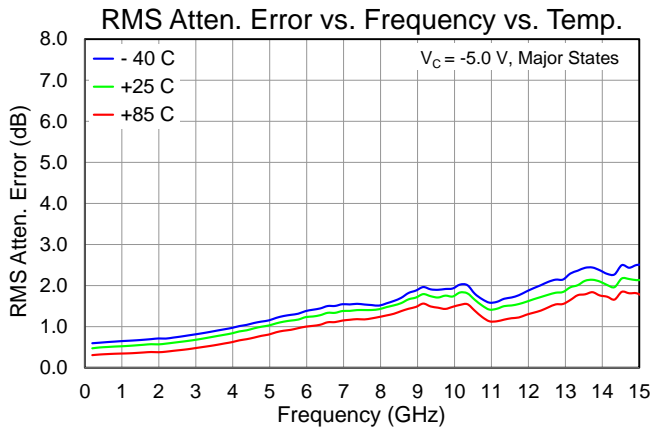

Performance Plots – Large Signal & Linearity

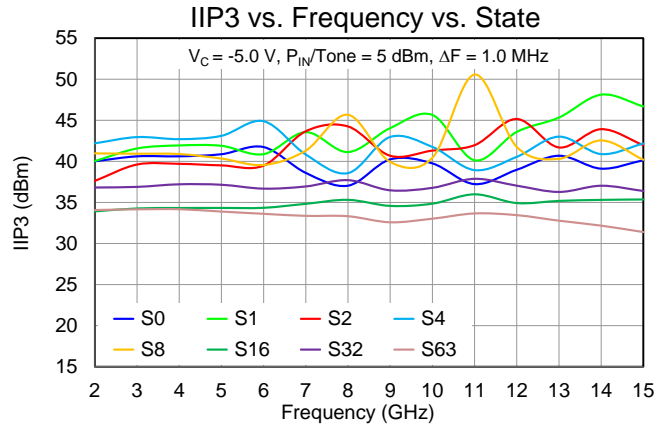
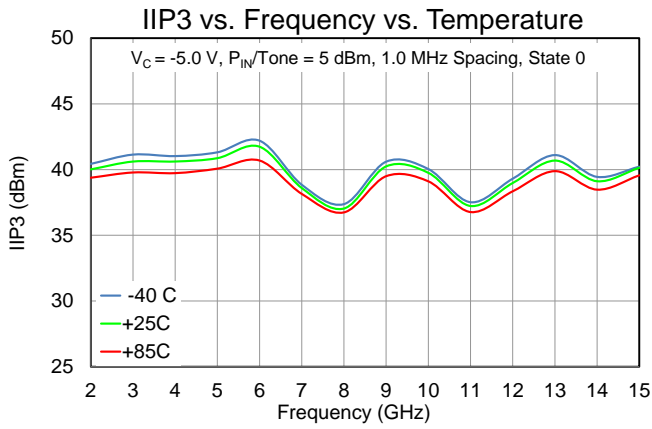
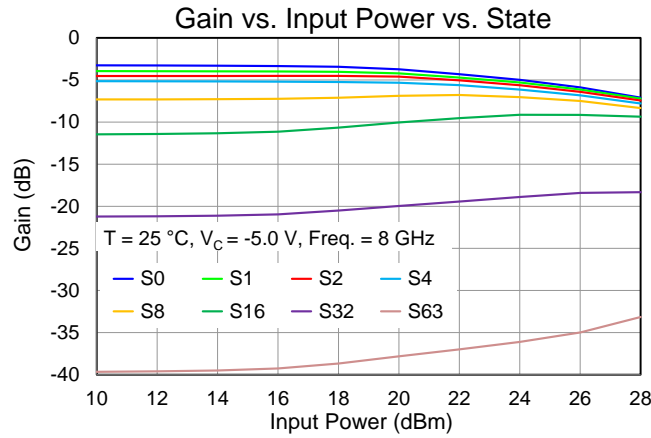

Thermal and Reliability Information

Parameter	Test Conditions	Value	Units
Thermal Resistance (θ_{JC}) ⁽¹⁾	$T_{BASE} = 85\text{ }^{\circ}\text{C}$, $V_C = -5.0\text{ V}$, $P_{IN} = 23\text{ dBm}$, $P_{DISS} = 0.105\text{ W}$	56.9	$^{\circ}\text{C/W}$
Channel Temperature (T_{CH})		102	$^{\circ}\text{C}$
Median Lifetime (T_M)		5.6E+8	Hrs

1. Package base backside temperature fixed at 85 $^{\circ}\text{C}$.

Median Lifetime

Test Conditions: 6.0 V; Failure Criterion = 10% reduction in $I_{D\text{ MAX}}$

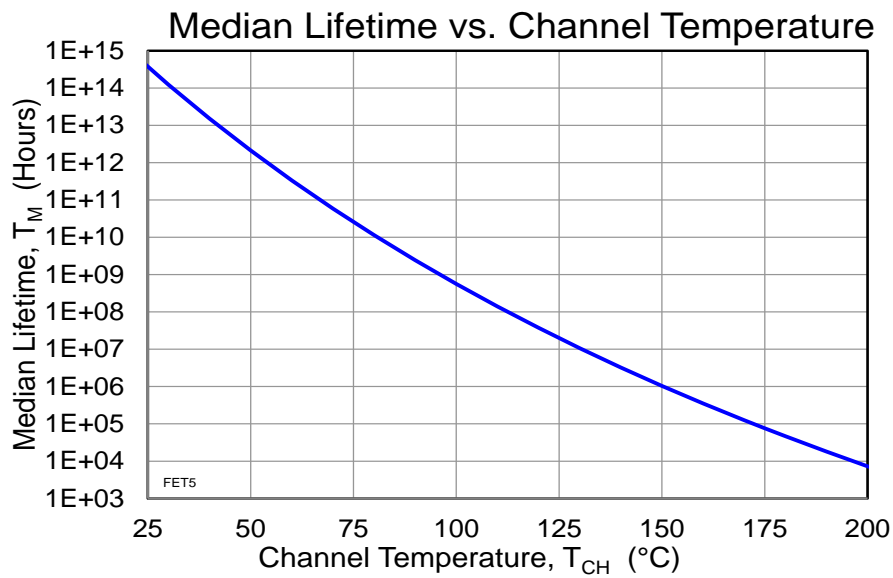

Applications Circuit

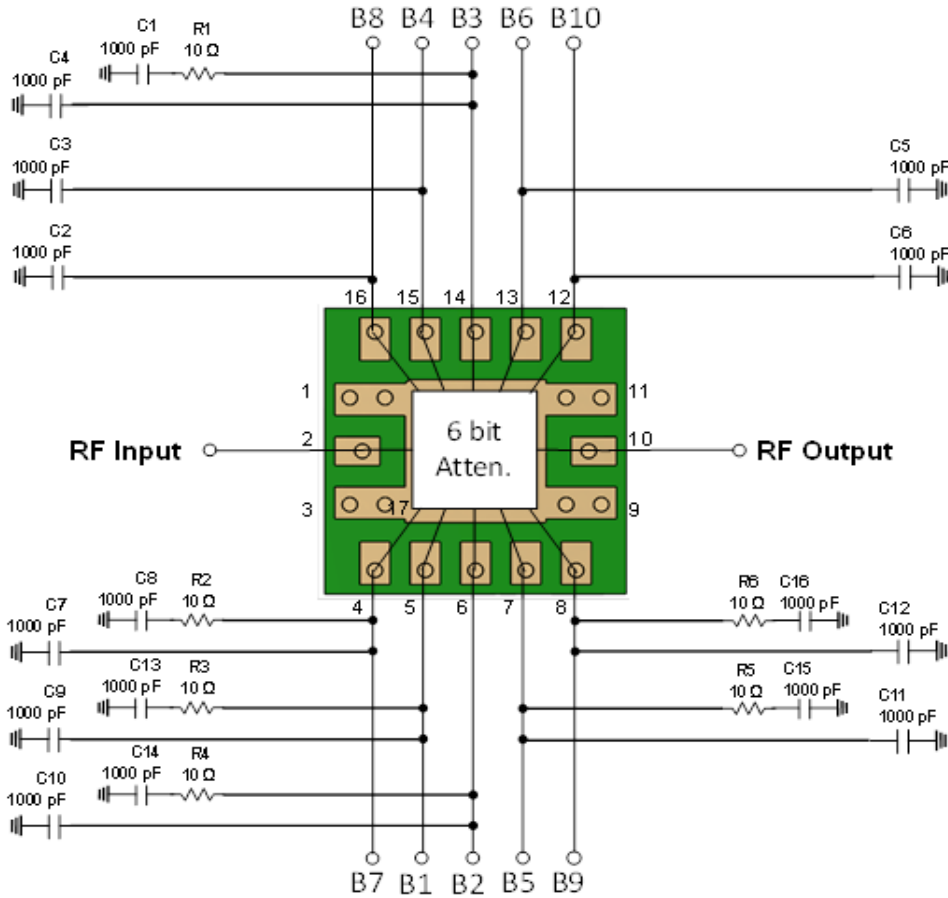

Function Table – Major States

Parameter	State	B1	B2	B3	B4	B5	B6	B7	B8	B9	B10
0.0 dB Attenuation (Ref. State)	State 0	0	0	1	0	1	0	1	0	1	0
0.5 dB Attenuation	State 1	1	0	1	0	1	0	1	0	1	0
1.0 dB Attenuation	State 2	0	1	1	0	1	0	1	0	1	0
2.0 dB Attenuation	State 4	0	0	0	1	1	0	1	0	1	0
4.0 dB Attenuation	State 8	0	0	1	0	0	1	1	0	1	0
8.0 dB Attenuation	State 16	0	0	1	0	1	0	0	1	1	0
16.0 dB Attenuation	State 32	0	0	1	0	1	0	1	0	0	1
24.0 dB Attenuation	State 48	0	0	1	0	1	0	0	1	0	1
28.0 dB Attenuation	State 56	0	0	1	0	0	1	0	1	0	1
31.5 dB Attenuation	State 63	1	1	0	1	0	1	0	1	0	1

Intermediate attenuation states are combinations of the above major states.

Logic 1 (H) = 0 V. Logic 0 (L) = -3.0 to -5.0 V

Note: RF Input and RF Output are both DC coupled.

Evaluation Board (EVB) Layout Assembly & Mounting Detail

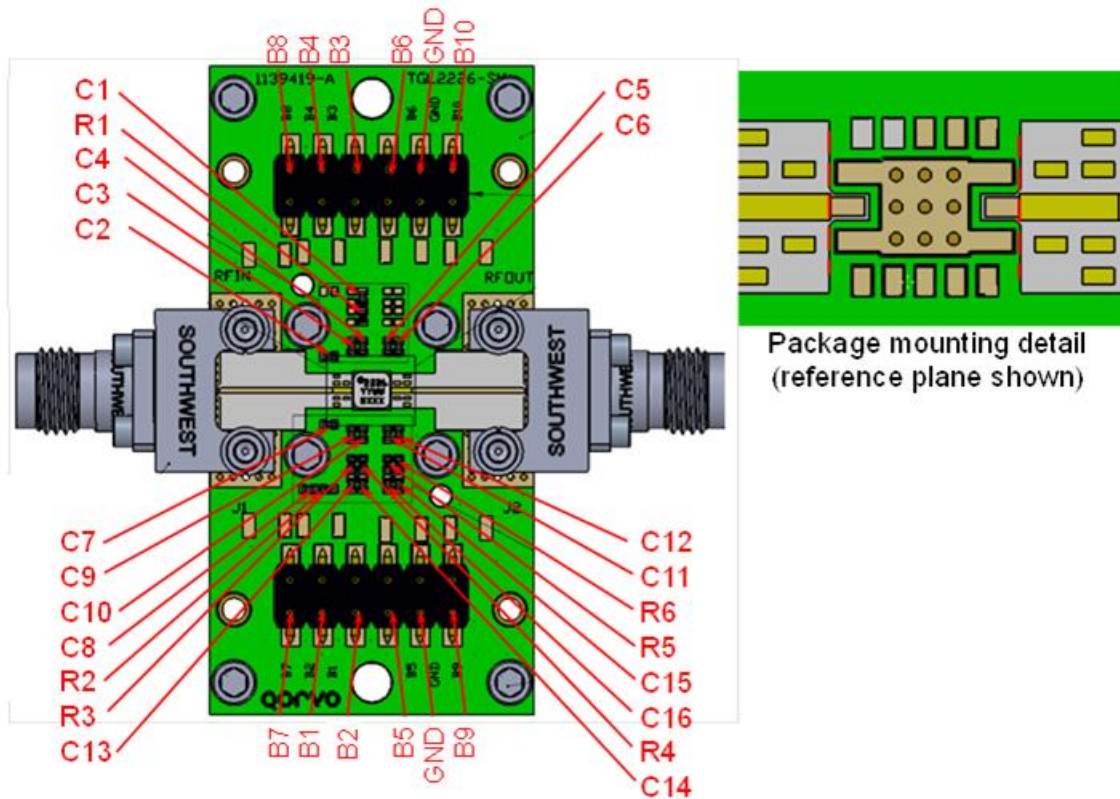

RF Layer is 0.008" thick Rogers Corp. RO4003C, $\epsilon_r = 3.38$. Metal layers are 0.5 oz. copper. The microstrip line at the connector interface is optimized for the Southwest Microwave end launch connector 1492-04A-5.

Reference plane is at the package.

Note: Multiple vias should be employed under die to minimize inductance and thermal resistance.

Bill of Materials for EVB

Reference Des.	Value	Description	Manuf.	Part Number
C1 – C16	1000 pF	CAP, 0402, 50 V, 10 %, X7R	Various	–
R1 – R6	10 Ohm	RES, 0402, 5 %, SMD	Various	–

Mechanical Information and Pins Description

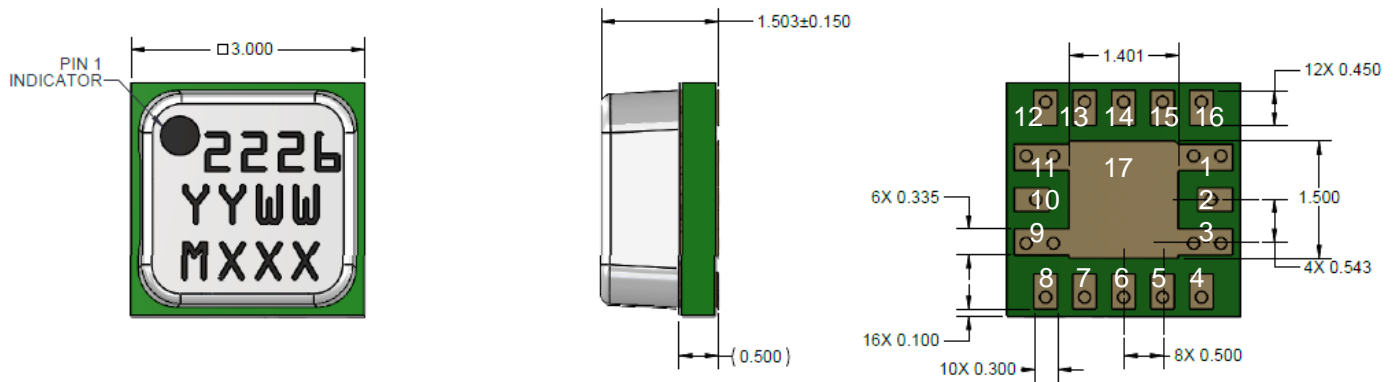

PART MARKING:
 2226 = PART NUMBER
 YY= LOT YEAR
 WW = LOT WEEK
 MXXX: LOT NUMBER
 Dimensions are in millimeters

Pin No.	Symbol	Description
1, 3, 9, 11, 17 (slug)	GND	Ground
2	RF IN	RF Input; Matched to 50 ohms; DC coupled
4	B7	Control Line for 8.0 dB bit (complement of B8)
5	B1	Control Line for 0.5 dB bit
6	B2	Control Line for 1.0 dB bit
7	B5	Control Line for 4.0 dB bit (complement of B6)
8	B9	Control Line for 16.0 dB bit (complement of B10)
10	RF OUT	RF Output; Matched to 50 ohms; DC coupled
12	B10	Control Line for 16.0 dB bit
13	B6	Control Line for 4.0 dB bit
14	B3	Control Line for 2.0 dB bit (complement of B4)
15	B4	Control Line for 2.0 dB bit
16	B8	Control Line for 8.0 dB bit

Solderability

- Compatible with lead-free soldering process with 260°C peak reflow temperature.
- This package is non-hermetic, and therefore cannot be subjected to aqueous washing. The use of no-clean solder to avoid washing after soldering is recommended
- Contact plating: Ni-Au

Recommended Soldering Profile

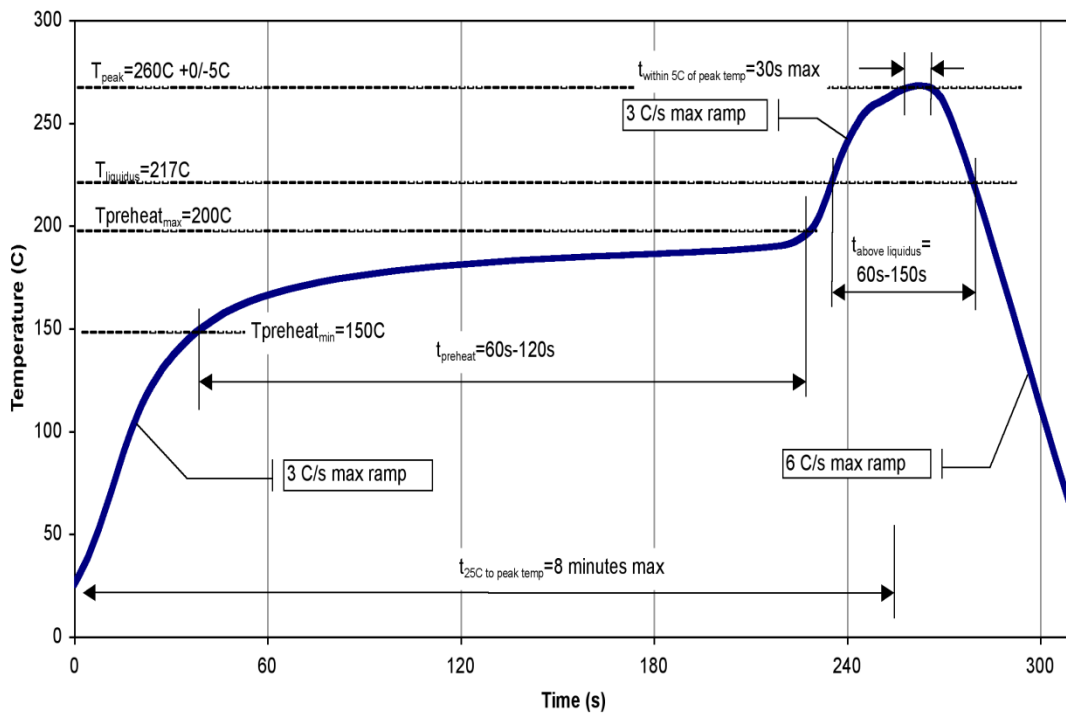

Handling Precautions

Parameter	Rating	Standard
ESD – Human Body Model (HBM)	Class 0A	ANSI /ESD/JEDEC JS-001
ESD – Charge Device Model (CDM)	Class C3	ANSI /ESD/JEDEC JS-002
MSL – Moisture Sensitivity Level	Level 3	IPC/JEDEC J-STD-020



Caution!
ESD-Sensitive Device

RoHS Compliance

This product is compliant with the 2011/65/EU RoHS directive (Restrictions on the Use of Certain Hazardous Substances in Electrical and Electronic Equipment), as amended by Directive 2015/863/EU. This product also has the following attributes:

- Lead Free
- Halogen Free
- Antimony Free
- TBBP-A (C₁₅H₁₂Br₄O₂) Free
- PFOS Free

Contact Information

For the latest specifications, additional product information, worldwide sales and distribution locations:

Tel: 1-844-890-8163

Web: www.qorvo.com

Email: customer.support@qorvo.com

Important Notice

The information contained herein is believed to be reliable; however, Qorvo makes no warranties regarding the information contained herein and assumes no responsibility or liability whatsoever for the use of the information contained herein. All information contained herein is subject to change without notice. Customers should obtain and verify the latest relevant information before placing orders for Qorvo products. The information contained herein or any use of such information does not grant, explicitly or implicitly, to any party any patent rights, licenses, or any other intellectual property rights, whether with regard to such information itself or anything described by such information. **THIS INFORMATION DOES NOT CONSTITUTE A WARRANTY WITH RESPECT TO THE PRODUCTS DESCRIBED HEREIN, AND QORVO HEREBY DISCLAIMS ANY AND ALL WARRANTIES WITH RESPECT TO SUCH PRODUCTS WHETHER EXPRESS OR IMPLIED BY LAW, COURSE OF DEALING, COURSE OF PERFORMANCE, USAGE OF TRADE OR OTHERWISE, INCLUDING THE IMPLIED WARRANTIES OF MERCHANTABILITY AND FITNESS FOR A PARTICULAR PURPOSE.**

Without limiting the generality of the foregoing, Qorvo products are not warranted or authorized for use as critical components in medical, life-saving, or life-sustaining applications, or other applications where a failure would reasonably be expected to cause severe personal injury or death.

Copyright 2019 © Qorvo, Inc. | Qorvo is a registered trademark of Qorvo, Inc.

X-ON Electronics

Largest Supplier of Electrical and Electronic Components

Click to view similar products for [Attenuators](#) category:

Click to view products by [Qorvo](#) manufacturer:

Other Similar products are found below :

[ATN3580-01](#) [HMC305SLP4ETR](#) [MAAD-009195-000100](#) [TGL4201-00](#) [TGL4201-02](#) [TGL4201-03](#) [TGL4201-06](#) [TGL4201-10](#) [ATN3590-15](#) [20-50TPC](#) [D10AA5Z4](#) [18AH-01](#) [18AH-08](#) [ATN3580-20](#) [ATN3590-09](#) [20-50RP](#) [MASW-008322-000000](#) [PCAF-10](#) [EXB-24AT9AR5X](#) [ATN3580-10](#) [HMC539ALP3ETR](#) [ATN3580-02](#) [WA04P006XCTL](#) [SKY12408-321LF](#) [ATN3580-03](#) [WA04P005XBTL](#) [HMC-VVD104-SX](#) [WA04P007XCTL](#) [SKY12236-11](#) [MAATSS0018TR-3000](#) [HMC656-SX](#) [WA04P001XBTL](#) [MAAV-007941-TR3000](#) [WA04P004XBTL](#) [WA04P002XBTL](#) [HMC941A](#) [PAT0816-C-0DB-T5](#) [PAT0816-C-8DB-T5](#) [PAT0816-C-10DB-T5](#) [PAT1632-C-3DB-T1](#) [PAT1632-C-6DB-T1](#) [PAT1632-C-10DB-T1](#) [PAT1632-C-1DB-T1](#) [PAT0816-C-2DB-T5](#) [PAT0816-C-4DB-T5](#) [DHM510-0100-006](#) [MAT10300](#) [MAT10180](#) [MAATCC0007-TB](#) [MAATCC0011](#)