

Product Description

Qorvo’s TGL2616-SM is a 5-bit digital attenuator using TQPHT15, Qorvo’s production 0.15um GaAs pHEMT process. Operating from 10 – 20 GHz, the TGL2616-SM offers a low LSB of only 0.75 dB and supports > 23 dB of attenuation range with a low RMS step error of < 0.3 dB.

Using standard, positive control voltages, offered in a 4x4mm air cavity QFN, and offering excellent broadband performance, the TGL2616-SM is ideal for supporting a variety of commercial and military applications.

Lead-free and RoHS compliant.

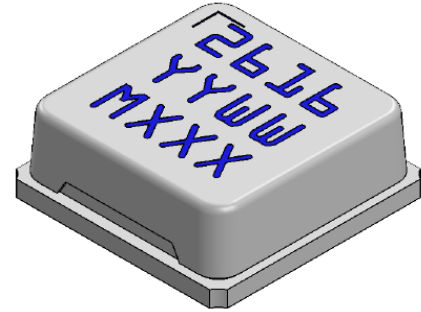

4 x 4 mm Air Cavity QFN Package

Product Features

- Frequency Range: 10 – 20 GHz
- 5-Bit Digital Attenuator
- Attenuation Range: 23.25 dB
- Attenuation Step Size (LSB): 0.75 dB
- Insertion Loss (Ref. State): 4.8 dB
- RMS Attenuation Error: < 0.6 dB
- Control Voltage: 3.3 to 5.0 V
- Positive Logic
- Package Size: 4.0 x 4.0 x 1.47 mm

Performance is typical across frequency. Please reference electrical specification table and data plots for more details.

Block Diagram

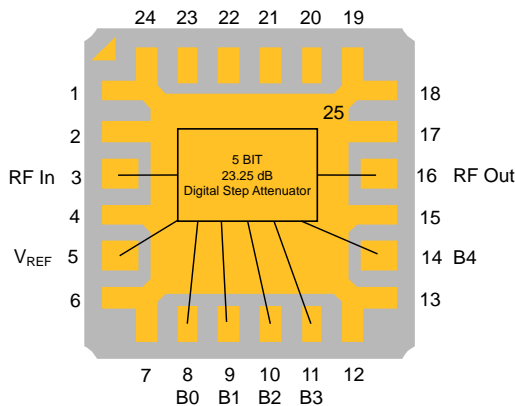

Applications

- Commercial and Military Radar
- Satellite Communications
- Point to Point Radio
- Electronic Warfare
- General Purpose

Ordering Information

Part No.	Description
TGL2616-SM	TGL2616-SM 10–20 GHz 5-Bit Digital Attenuator
TGL2616-SMEVB1	TGL2616-SM EVAL BOARD

Absolute Maximum Ratings

Parameter	Value/Range
Control Voltage (V_C)	6 V
Control Current (I_C)	1 mA
Input Power (P_{IN})	35 dBm
Power Dissipation (P_{DISS})	0.7 W
Mounting Temperature (30 seconds)	260 °C
Operating Channel Temperature	150 °C
Storage Temperature	-55 to 150 °C

Operation of this device outside the parameter ranges given above may cause permanent damage. These are stress ratings only, and functional operation of the device at these conditions is not implied.

Recommended Operating Conditions

Parameter	Value/Range
Reference Voltage ¹ (V_{REF})	3.5 – 5 V
Control Voltage (V_C) - (Logic H)	3.5 – 5 V
Control Voltage (V_C) - (Logic L)	0 V
Operating Temperature Range	-40 to +85 °C

Note: ¹ $V_{REF} \geq V_C$.

Electrical specifications are measured at specified test conditions. Specifications are not guaranteed over all recommended operating conditions.

Electrical Specifications

Test conditions, unless otherwise noted: 25 °C, $V_{REF} = 5$ V, $V_C = 0 / 5$ V. Tested with DUT on EVB on page 10.

Parameter	Min	Typ.	Max	Units
Operational Frequency Range	10	–	20	GHz
LSB Attenuation		0.75		dB
Attenuation Range		23.25		dB
Reference State Insertion Loss		4.8		dB
Input Return Loss		> 8		dB
Output Return Loss		> 12		dB
IIP3 (10 MHz spacing, $P_{IN}/\text{Tone}=10$ dBm, 15 GHz) ¹		> 36		dBm
Switching Speed (90%-10%)		< 10		ns
RMS Attenuation Error		< 0.7		dB
RMS Step Error		< 0.3		dB
Max. Attenuation Error		< 1.1		dB

¹ TGL2616 die performance.

Performance Plots – Small Signal

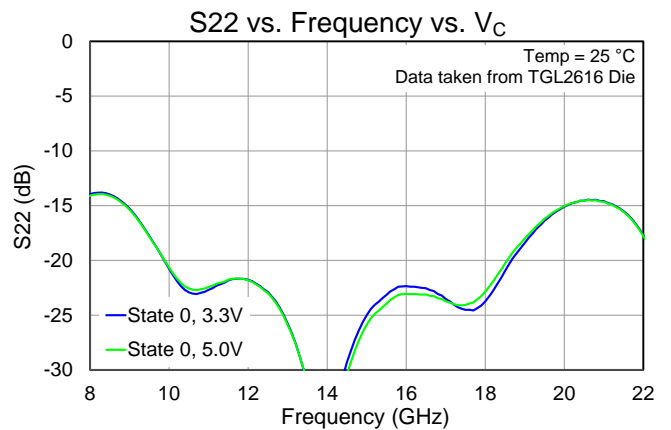
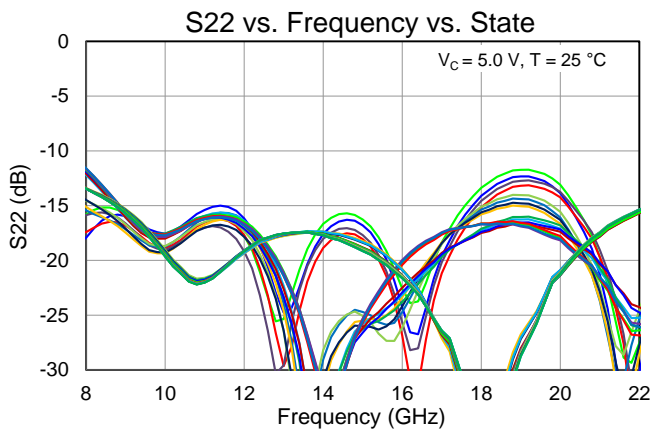
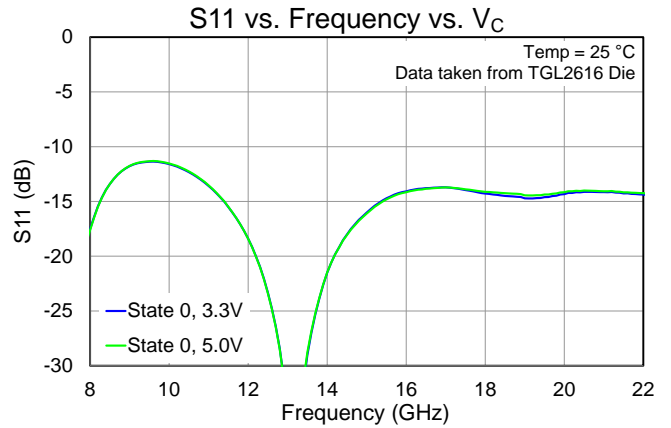
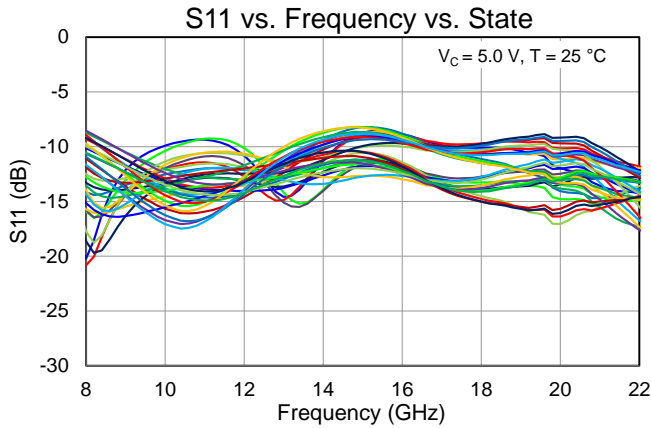
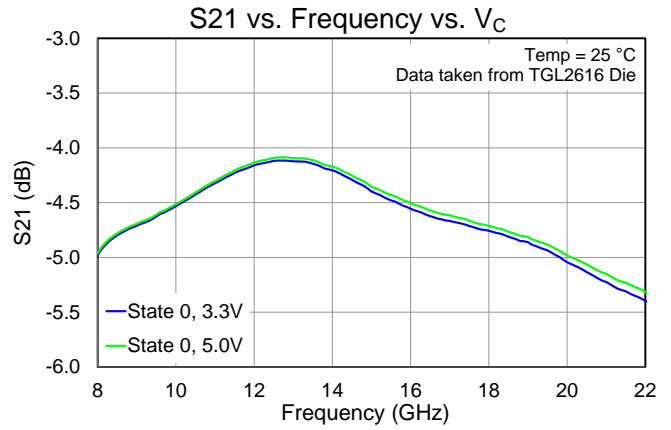
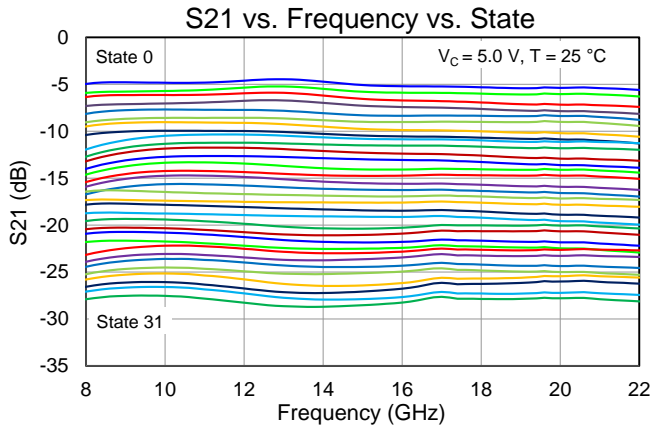

Performance Plots – Small Signal

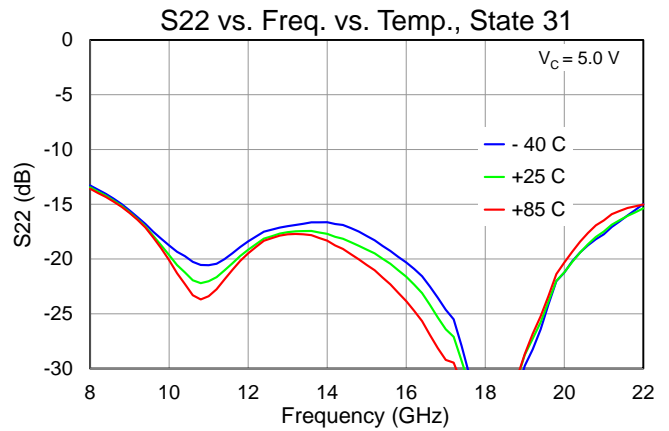
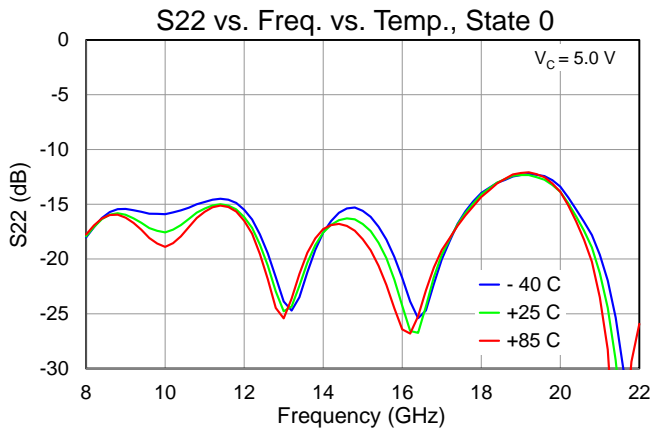
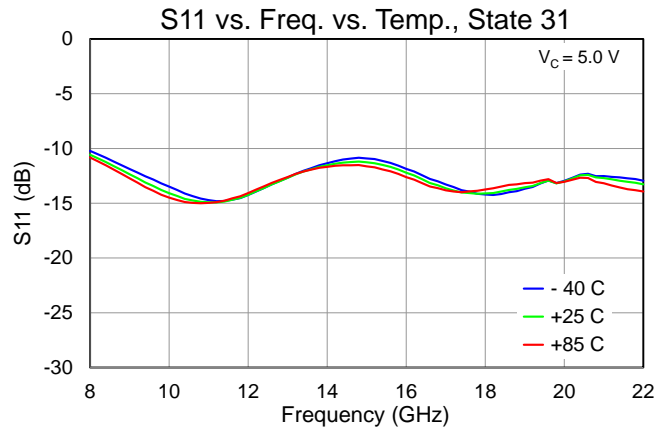
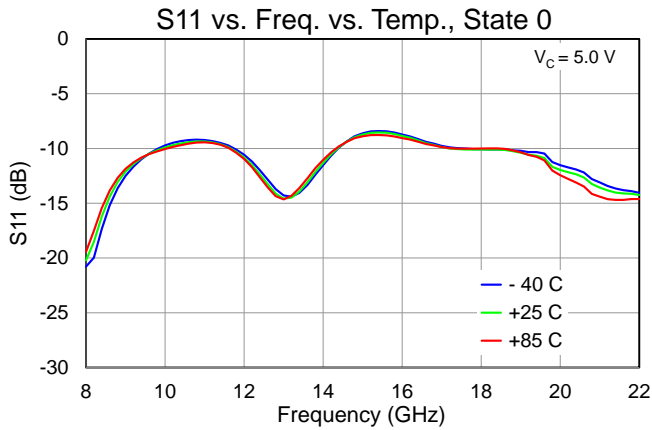
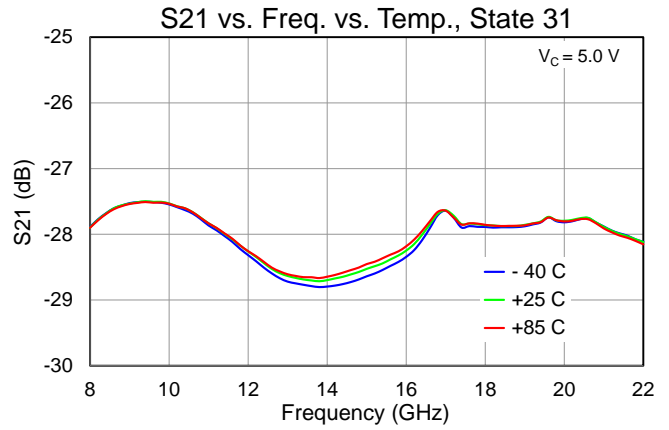
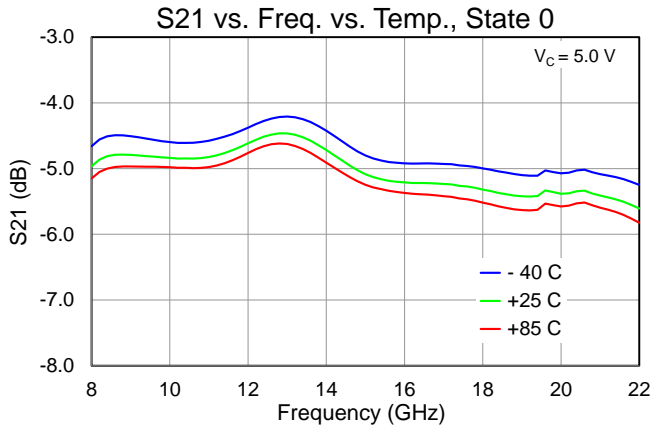

Performance Plots – Small Signal

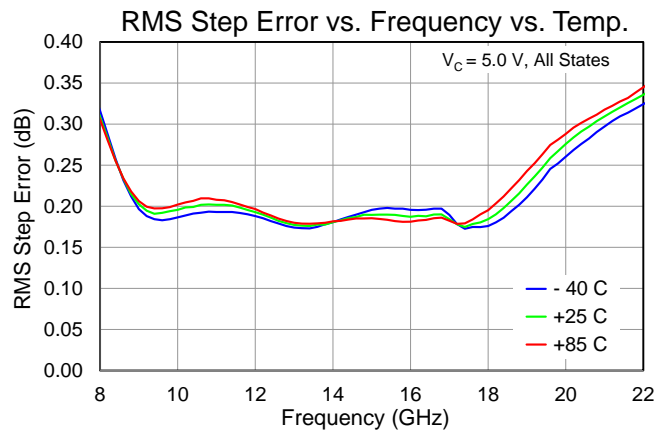
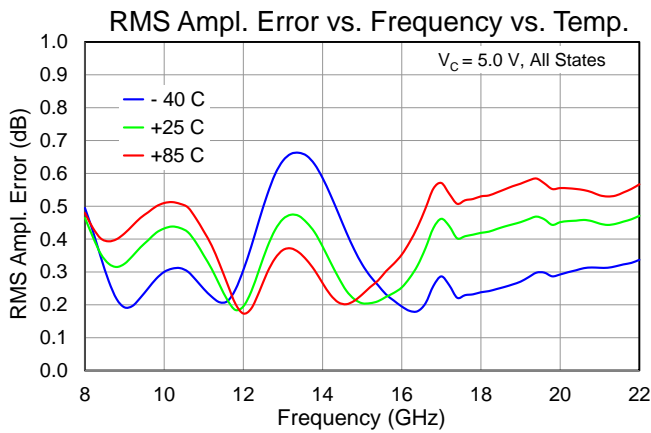
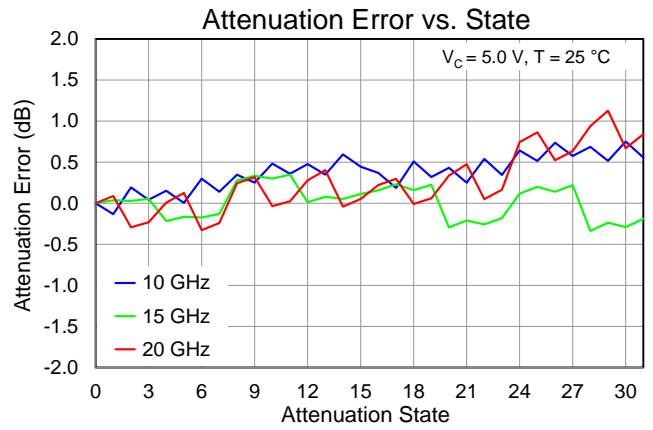
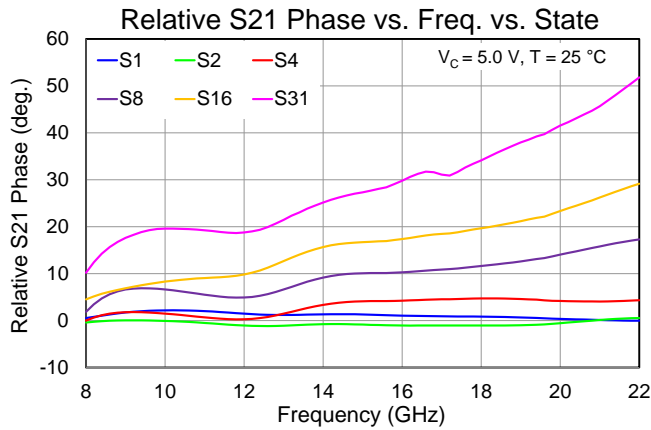
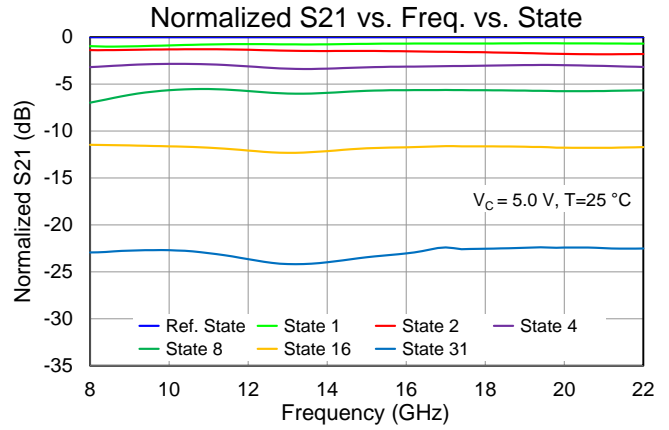
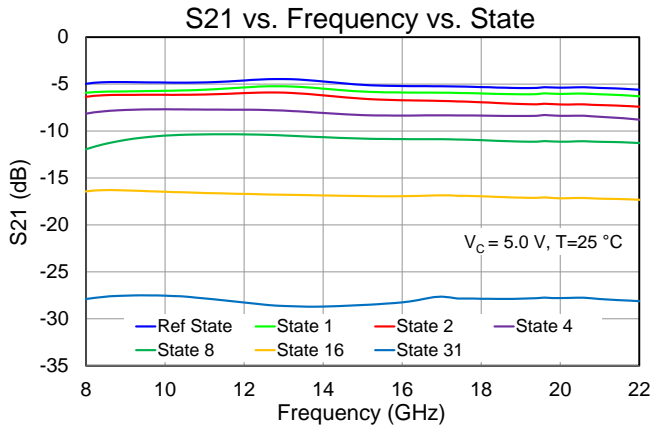

Performance Plots – Small Signal, Large Signal & Linearity

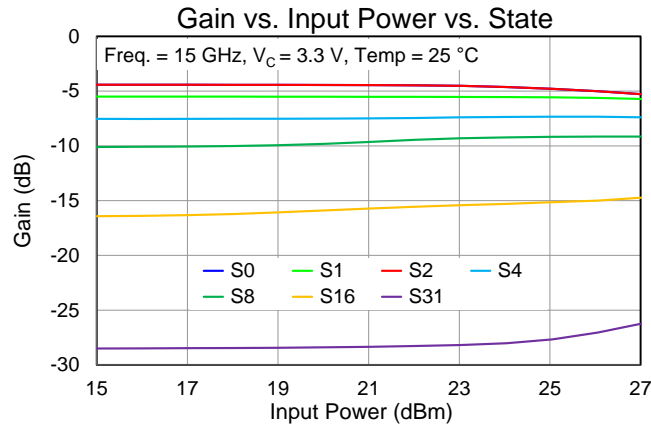
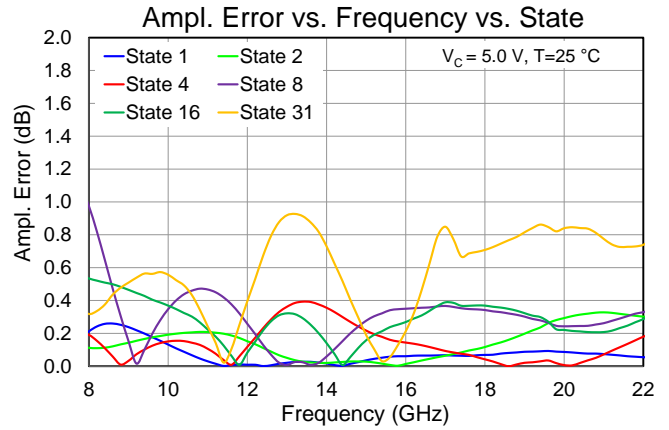
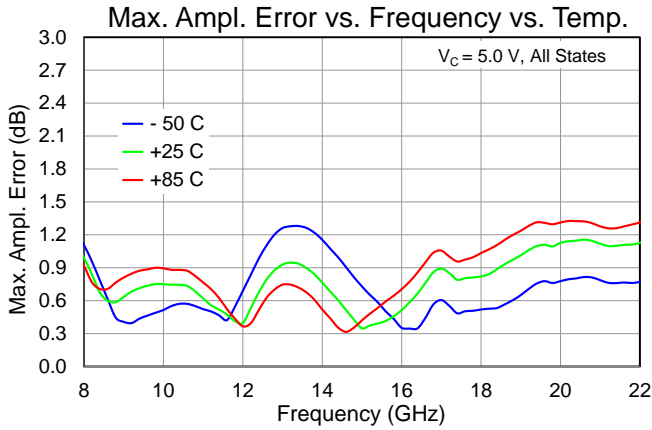

This plot is from TGL2616 die

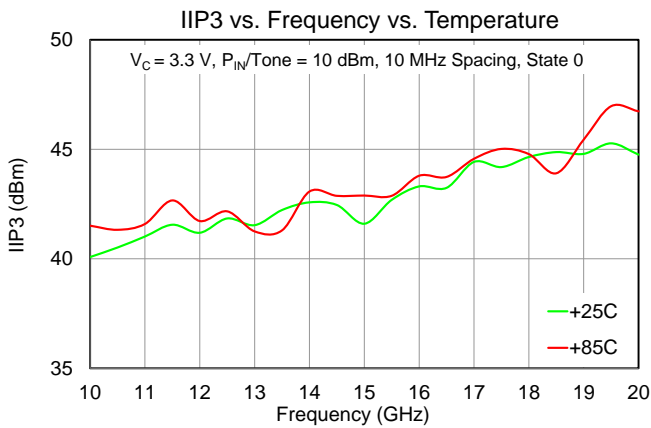

This plot is from TGL2616 die

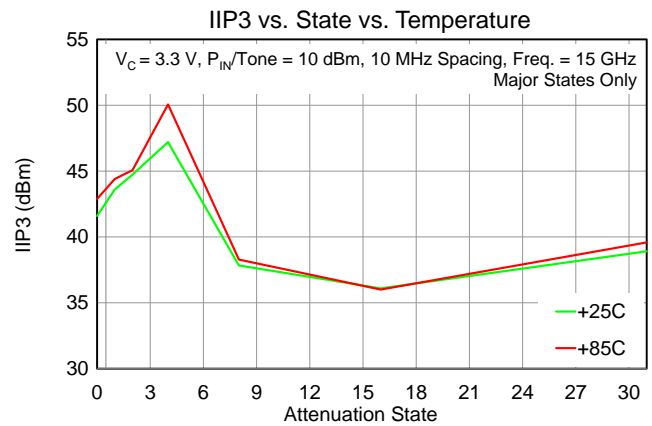

This plot is from TGL2616 die

Performance Plots – Small Signal: 5 GHz to 22 GHz

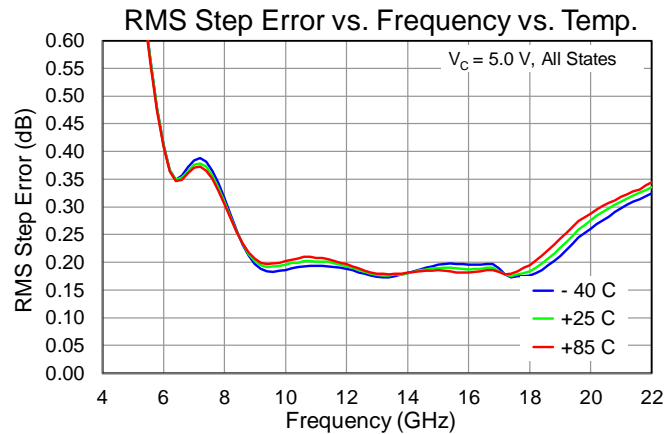
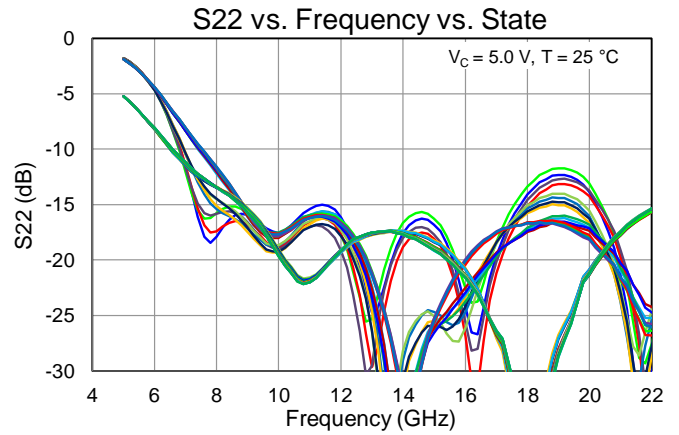
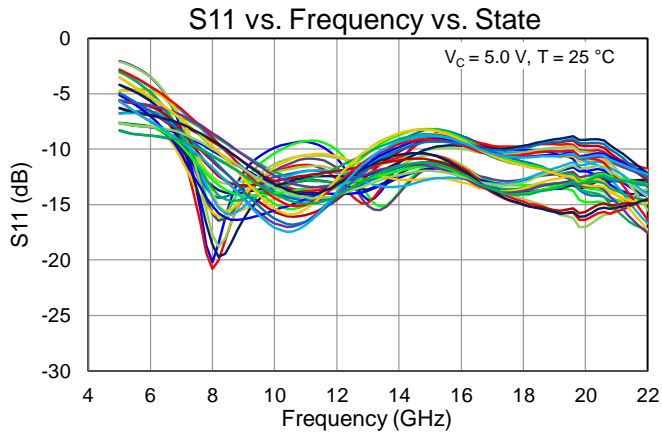
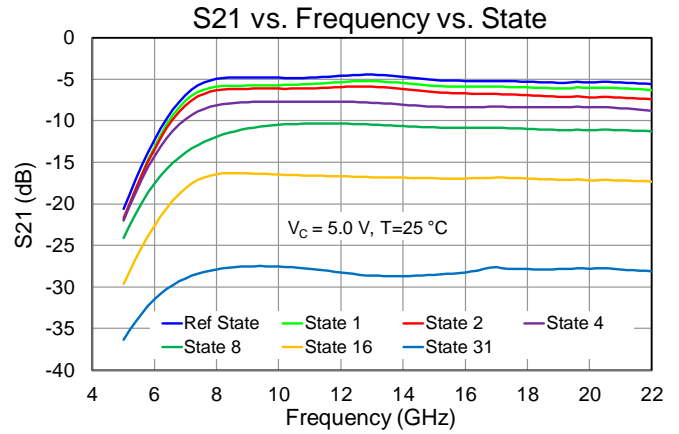
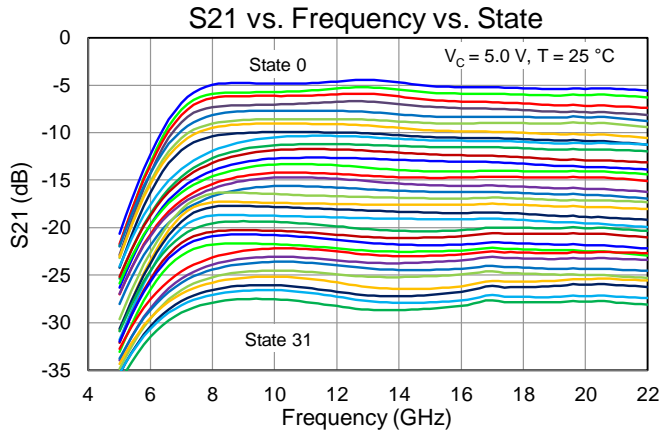

Thermal and Reliability Information

Parameter	Test Conditions	Value	Units
Thermal Resistance (θ_{JC}) ⁽¹⁾	$T_{BASE} = 85^{\circ}\text{C}$, $V_{REF} = 3.3\text{ V}$, $V_C = 3.3\text{ V}$, $P_{DISS} = 0.09\text{ W}$	22	$^{\circ}\text{C/W}$
Channel Temperature (T_{CH})		87	$^{\circ}\text{C}$
Median Lifetime (T_M)		3.8E+09	Hrs

1. Package base backside temperature fixed at 85 $^{\circ}\text{C}$.

Median Lifetime

Test Conditions: 6.0 V; Failure Criterion = 10% reduction in $I_{D\text{ MAX}}$

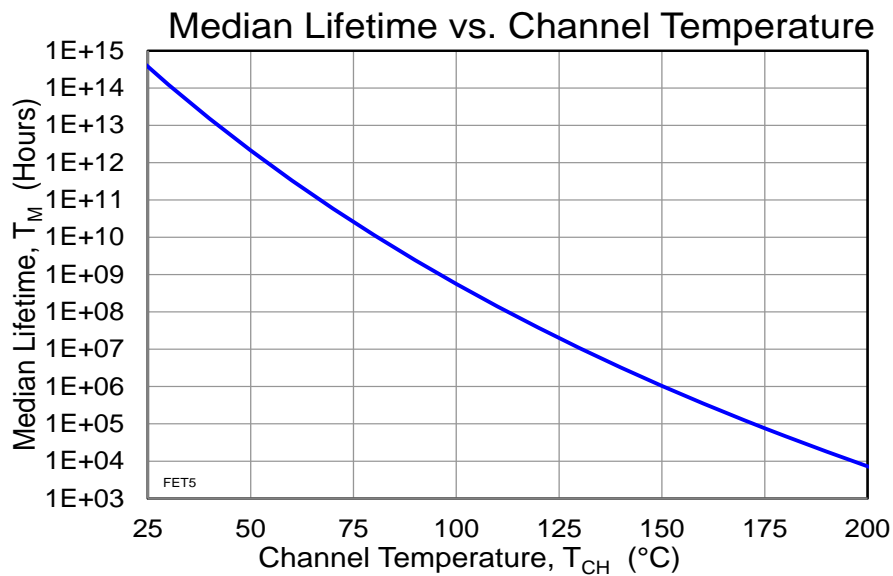

Applications Circuit

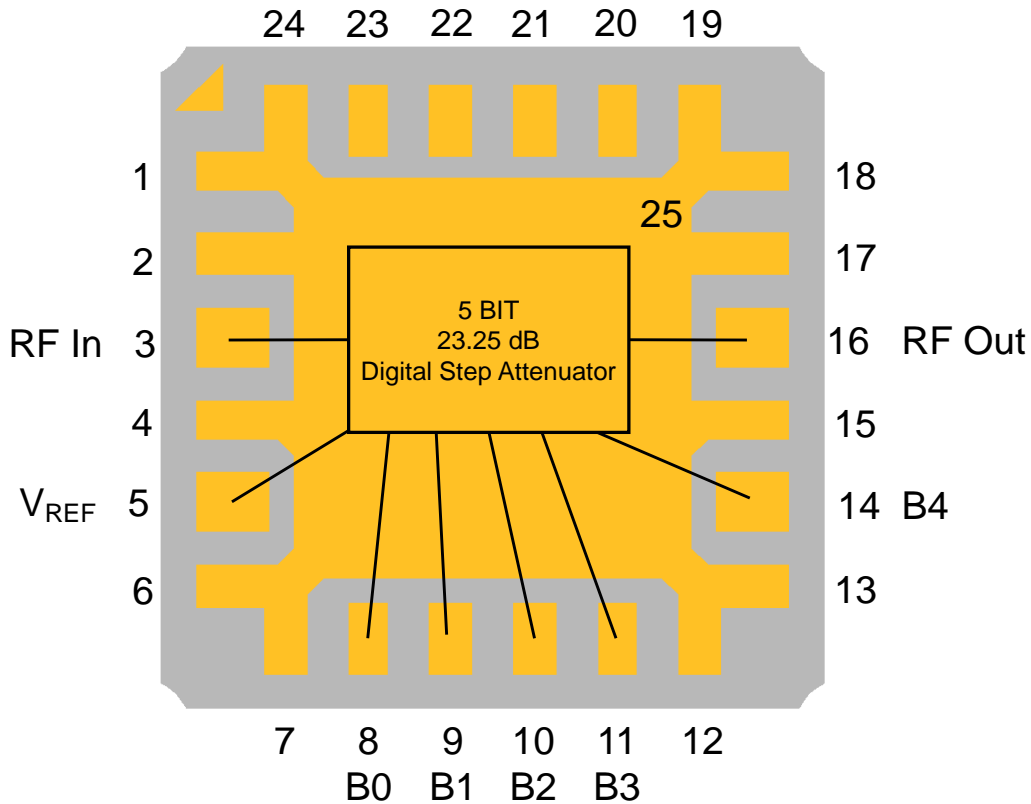

Function Table – Major States

Parameter	State	B0	B1	B2	B3	B4
0.0 dB Attenuation (Ref. State)	State 0	L	L	L	L	L
0.75 dB Attenuation	State 1	H	L	L	L	L
1.5 dB Attenuation	State 2	L	H	L	L	L
3.0 dB Attenuation	State 4	L	L	H	L	L
6.0 dB Attenuation	State 8	L	L	L	H	L
12.0 dB Attenuation	State 16	L	L	L	L	H
23.25 dB Attenuation	State 31	H	H	H	H	H

Intermediate attenuation states are combinations of the above major states.

Logic L = 0 V. Logic H = 3.3 to 5.0 V

Evaluation Board (EVB) Layout Assembly & Mounting Detail

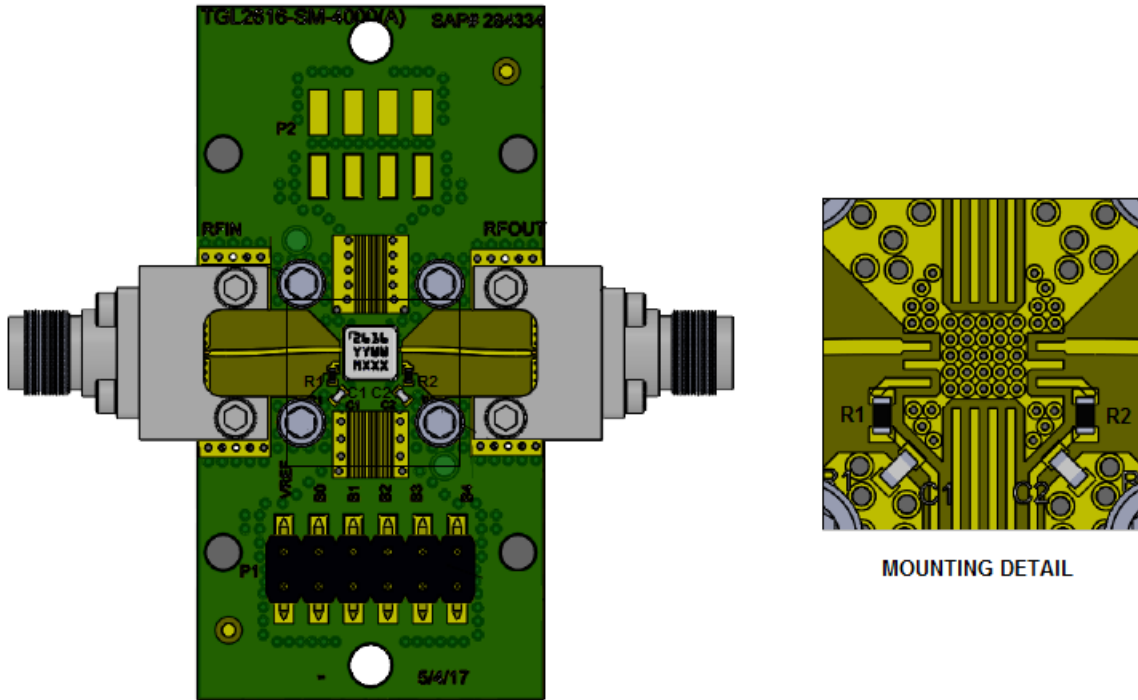

RF Layer is 0.008” thick Rogers Corp. RO4003C, er = 3.38. Metal layers are 0.5 oz. copper. The microstrip line at the connector interface is optimized for the Southwest Microwave end launch connector 1092-01A-5.

The pad pattern shown has been developed and tested for optimized assembly at Qorvo. The PCB land pattern has been developed to accommodate lead and package tolerances. Since surface mount processes vary from company to company, careful process development is recommended.

Note: Multiple vias should be employed under package to minimize inductance and thermal resistance.

Bill of Materials for EVB

Reference Des.	Value	Description	Mfg.	Part Number
C1 – C2	0.5 pF	CAP, 0402, 50 V, ±0.1 pF, COG	Various	–
R1 – R2	180 Ohms	RES, 0402 Case	Various	–

Mechanical Information

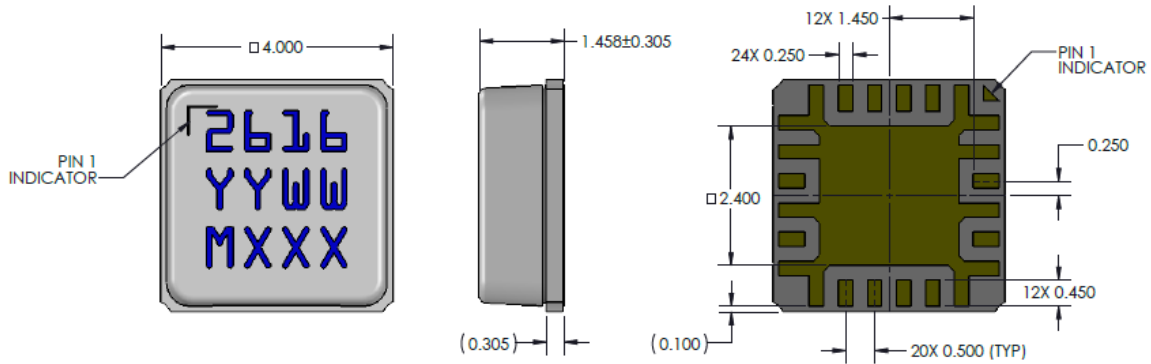

Dimensions are in millimeters

NOTES:

1. PACKAGE BASE: CERAMIC
2. PACKAGE LID: PLASTIC
3. ALL METALIZED FEATURES ARE GOLD PLATED.
4. THE PART IS EPOXY SEALED
5. PART MARKING:
 - 2616: PART NUMBER
 - YY: PART ASSY YEAR
 - WW: PART ASSY WEEK
 - MXXX: BATCH ID

Pins Description

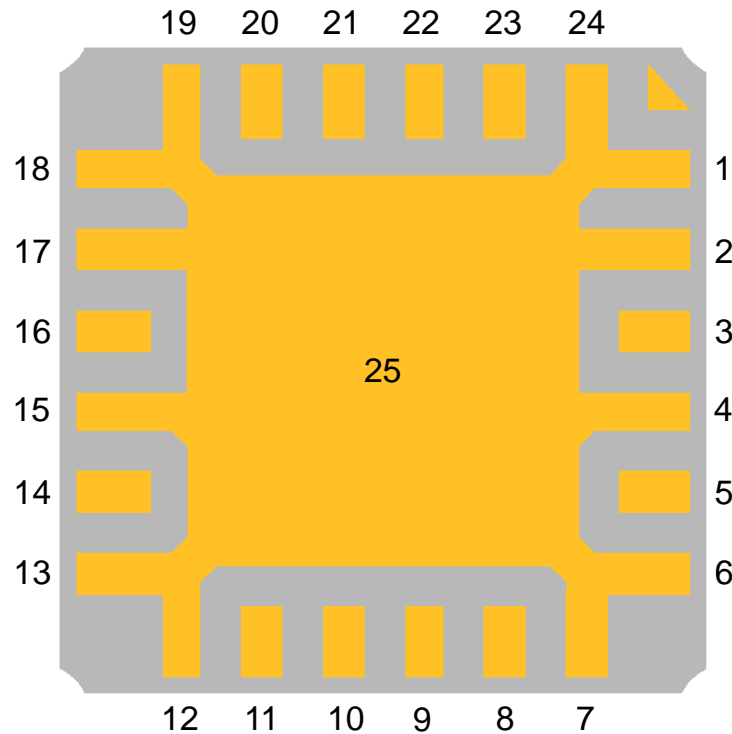

Bottom view of package base

Pin No.	Symbol	Description
1, 2, 4, 6, 7, 12, 13, 15, 17, 18, 19, 24, 25 (slug)	GND	Ground. On PCB, multiple vias should be employed under 25 (center pad) to minimize inductance and thermal resistance.
3	RF IN	RF Input, AC coupled
5	V _{REF}	Reference Voltage
8	B0 (0.75 dB Bit)	Control Line for Bit 0
9	B1 (1.5 dB Bit)	Control Line for Bit 1
10	B2 (3 dB Bit)	Control Line for Bit 2
11	B3 (6 dB Bit)	Control Line for Bit 3
14	B4 (12 dB Bit)	Control Line for Bit 4
16	RF OUT	RF Output, AC coupled
20 – 23	N/C	No connection

Solderability

- Compatible with lead-free soldering process with 260°C peak reflow temperature.
- This package is non-hermetic, and therefore cannot be subjected to aqueous washing. The use of no-clean solder to avoid washing after soldering is recommended
- Contact plating: Ni-Au

Recommended Soldering Profile

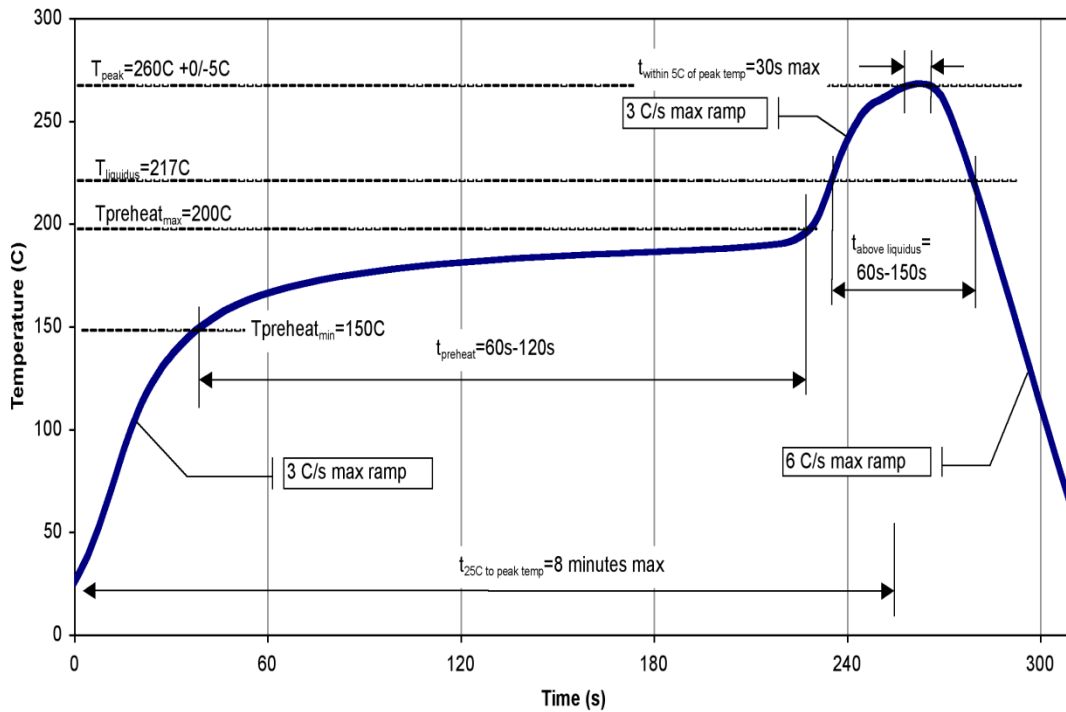

Handling Precautions

Parameter	Rating	Standard
ESD – Human Body Model (HBM)	Class 0A	ANSI/ESD/JEDEC JS-001
ESD – Charge Device Model (CDM)	Class C1	JESD22-C101
MSL – Moisture Sensitivity Level	Level 3	IPC/JEDEC J-STD-020



Caution!
ESD-Sensitive Device

RoHS Compliance

This product is compliant with the 2011/65/EU RoHS directive (Restrictions on the Use of Certain Hazardous Substances in Electrical and Electronic Equipment), as amended by Directive 2015/863/EU. This product also has the following attributes:

- Lead Free
- Halogen Free (Chlorine, Bromine)
- Antimony Free
- TBBP-A (C₁₅H₁₂Br₄O₂) Free
- PFOS Free
- SVHC Free

Contact Information

For the latest specifications, additional product information, worldwide sales and distribution locations:

Tel: 1-844-890-8163

Web: www.qorvo.com

Email: customer.support@qorvo.com

Important Notice

The information contained herein is believed to be reliable; however, Qorvo makes no warranties regarding the information contained herein and assumes no responsibility or liability whatsoever for the use of the information contained herein. All information contained herein is subject to change without notice. Customers should obtain and verify the latest relevant information before placing orders for Qorvo products. The information contained herein or any use of such information does not grant, explicitly or implicitly, to any party any patent rights, licenses, or any other intellectual property rights, whether with regard to such information itself or anything described by such information. **THIS INFORMATION DOES NOT CONSTITUTE A WARRANTY WITH RESPECT TO THE PRODUCTS DESCRIBED HEREIN, AND QORVO HEREBY DISCLAIMS ANY AND ALL WARRANTIES WITH RESPECT TO SUCH PRODUCTS WHETHER EXPRESS OR IMPLIED BY LAW, COURSE OF DEALING, COURSE OF PERFORMANCE, USAGE OF TRADE OR OTHERWISE, INCLUDING THE IMPLIED WARRANTIES OF MERCHANTABILITY AND FITNESS FOR A PARTICULAR PURPOSE.**

Without limiting the generality of the foregoing, Qorvo products are not warranted or authorized for use as critical components in medical, life-saving, or life-sustaining applications, or other applications where a failure would reasonably be expected to cause severe personal injury or death.

Copyright 2019 © Qorvo, Inc. | Qorvo is a registered trademark of Qorvo, Inc.

X-ON Electronics

Largest Supplier of Electrical and Electronic Components

Click to view similar products for [Attenuators](#) category:

Click to view products by [Qorvo](#) manufacturer:

Other Similar products are found below :

[ATN3580-01](#) [HMC305SLP4ETR](#) [MAAD-009195-000100](#) [TGL4201-00](#) [TGL4201-02](#) [TGL4201-03](#) [TGL4201-06](#) [TGL4201-10](#) [ATN3590-15](#) [20-50TPC](#) [D10AA5Z4](#) [18AH-01](#) [18AH-08](#) [ATN3580-20](#) [ATN3590-09](#) [20-50RP](#) [MASW-008322-000000](#) [MAATCC0009TR](#) [PCAF-10](#) [EXB-24AT9AR5X](#) [ATN3580-10](#) [HMC539ALP3ETR](#) [ATN3580-02](#) [WA04P006XCTL](#) [SKY12408-321LF](#) [ATN3580-03](#) [WA04P005XBTL](#) [HMC-VVD104-SX](#) [WA04P007XCTL](#) [SKY12236-11](#) [MAATSS0018TR-3000](#) [HMC656-SX](#) [WA04P001XBTL](#) [MAAV-007941-TR3000](#) [WA04P004XBTL](#) [WA04P002XBTL](#) [HMC941A](#) [PAT0816-C-0DB-T5](#) [PAT0816-C-8DB-T5](#) [PAT1632-C-3DB-T1](#) [PAT1632-C-6DB-T1](#) [PAT1632-C-10DB-T1](#) [PAT1632-C-1DB-T1](#) [PAT0816-C-2DB-T5](#) [PAT0816-C-4DB-T5](#) [DHM510-0100-006](#) [CMD172](#) [MAT10300](#) [MAT10180](#) [MAATCC0007-TB](#)